



**The ION 57th
Annual Meeting
and the
CIGTF 20th Biennial
Guidance Test
Symposium**

June 11–13, 2001
Crowne Plaza Pyramid Hotel
Albuquerque, NM

The Institute of Navigation
1800 Diagonal Road
Suite 480
Alexandria, VA 22314

Main Menu

Acknowledgments

Conference Registrants

Table of Contents

Author Index

ION Information

Search this CD-ROM

CD-ROM Help

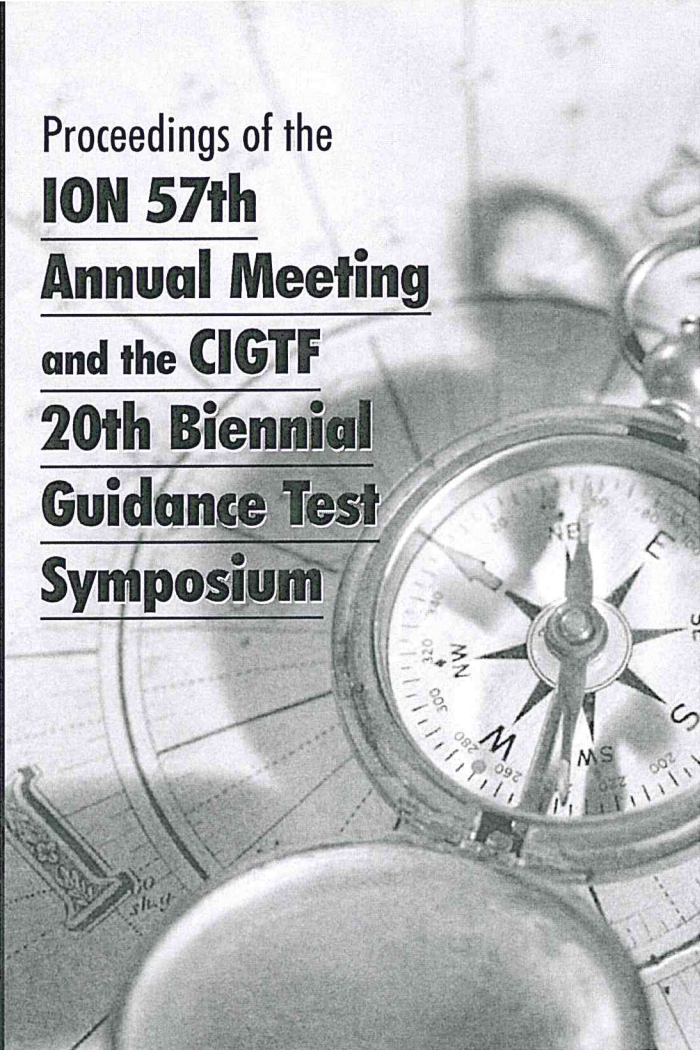

Proceedings of the
**ION 57th
Annual Meeting
and the CIGTF
20th Biennial
Guidance Test
Symposium**

www.ion.org

©2001

EXIT

TABLE OF CONTENTS

How To Use This Index: Scroll down or use the bookmarks in the navigation pane at left to move to a new location in this index. Click on a **blue paper title** to view that paper. To return to this index after viewing a paper, you must exit that paper (File > Close).

Some Material on this CD-ROM was created by scanning an author's paper original. Viewing of the text and graphics and the ease of readability will depend largely on the content requiring scanning and the quality and/or consistency of each author's paper original.

PLENARY SESSION

GPS Modernization

D. Loverro, *U.S. Air Force* 1

GPS Interagency Forum for Operational Requirements

S. Canzano, *AFSPC/DRN* 33

Civil GPS Applications

M.E. Shaw, *U.S. Department of Transportation* 48

GALILEO: Project or Reality?

L. Dutton, *Thales Avionics, UK* 74

SESSION A1a: FUTURE GNSS MODERNIZATION

Measurements of GPS Receiver Compatibility with Interplex-Modulated M-Code Signals

P.A. Dafesh, R.L. Wong, M.D. Partridge, T. Fan, *The Aerospace Corporation* 100

Navigation Professionals' Public Policy Positions on GLONASS

G.C. Chachis, *Titan Systems Corporation* 109

Matched Filter Mean Acquisition Time Performance for P(Y), BOC(10,5), and MAN(10) Codes With FFT Aiding and Noncoherent Combining

J.K. Holmes, P.A. Dafesh, *The Aerospace Corporation* 121

SESSION A1b: SPACE SYSTEMS & APPLICATIONS

Feasibility of Managing a Dynamic Constellation to a Fixed Constellation Definition

B.P. Ayati, P.D. Massatt, *The Aerospace Corporation* 140

Real-Time, Autonomous, Precise Orbit Determination Using GPS

D.B. Goldstein, *U.S. Air Force, GPS Joint Program Office*; G.H. Born, P. Axelrad, *University of Colorado* 149

A Positioning System for GEO Satellites Using GOES Weather Satellites as GPS-Type Pseudolites R.B. Ward, L. Capots, <i>Lockheed Martin Space Systems Company</i>	159
--	-----

Tracking Loop Optimization for On-Board GPS Navigation in High Earth Orbit (HEO) Missions J.L. Garrison, <i>Purdue University</i> ; M.C. Moreau, P. Axelrad, <i>University of Colorado</i>	168
--	-----

SESSION B1: 150TH ANNIVERSARY OF THE GYROSCOPE: A HISTORICAL PERSPECTIVE (IEEE Sponsored)

History of Ring Laser Gyroscope Development at Lockheed Martin (Formerly Sperry) J. Abdale, V. Benischek, W. Macek (retired), <i>Lockheed Martin Naval Electronics and Surveillance Systems</i>	176
---	-----

No Moving Parts: A Fiber Optic Gyroscope R.W. Shorthill, <i>University of Utah</i>	188
--	-----

Evolution of Precision IFOG G. Adams, <i>Honeywell International Corporation</i> ; N. Barnett, L. Insley, <i>Penn State University Applied Research Laboratory</i> ; S. Vajda, <i>Strategic Systems Program</i>	200
---	-----

Aerospace Technology and Low Automotive Costs Benefit Quartz Micromachined Gyros A.M. Madni, <i>BEI Technologies, Inc.</i> ; L.E. Costlow, R.P. Jaffe, <i>BEI Systron Donner Inertial Division</i>	205
--	-----

Strategic Testing at the Central Inertial Guidance Test Facility R.S. Lawrence, C.H. Barker, R.C. Sturdevant, <i>746th Test Squadron</i>	219
--	-----

The History of Laser Gyro Development in the Former Soviet Union D.P. Loukianov, Yu.V. Filatov, <i>St. Petersburg State Electrotechnical University, Russia</i> ; V.N. Kuryatov, <i>The Research and Development Institute "Polyus", Russia</i> ; V.P. Vasiliev, <i>The Institute for Precision Instruments Engineering, Russia</i> ; V.I. Buzanov, V.P. Spectorenko, O.I. Klochko, <i>The Central Design Bureau and the Plant "Arsenal", Russia</i>	225
--	-----

SESSION C1: AVIATION APPLICATIONS

Advanced Flight Display for General Aviation Aircraft: A Cost-Effective Means to Enhance Safety J.G. Dubinsky, M.S. Braasch, M. Uijt de Haag, <i>Ohio University Avionics Engineering Center</i>	238
--	-----

Analysis of Differential Tropospheric Delay Resulting from Vertical and Horizontal Displacements for the LAAS MOPS C. Varner, <i>The MITRE Corporation</i>	247
--	-----

LAAS Performance for Terminal Area Navigation R. Braff, <i>The MITRE Corporation</i>	252
--	-----

Antenna Techniques to Optimize Pseudorange Measurements for Ground Based Ranging Sources	
J. Dickman, C.G. Bartone, <i>Ohio University</i>	263
Aircraft Antenna Calibration for the LAAS VHF Data Broadcast	
O.K. Nyhus, <i>Honeywell</i> ; T.A. Skidmore, A.A. Wilson, <i>Ohio University</i>	275
Integration of DGPS and Precision Tracking Radar for Aircraft Precision Approach	
N. Nabaa, G. Clary, J. Cross, D. Howard, R. Thayer, <i>Sierra Nevada Corporation</i>	284
 SESSION D1: INTEGRATED POSITIONING & NAVIGATION SYSTEMS	
New Results from Time Domain Analysis of GPS Jamming Interference	
J. Lukesh, <i>Northrop-Grumman (retired)</i>	291
Enhanced Precision Reference Systems	
R.S. Lawrence, R. Pearson, J. Sanchez, B. Neal, <i>746th Test Squadron</i> ; R. Gurr, <i>Air Force Flight Test Center</i> ; N. Carlson, <i>Integrity Systems Inc.</i>	304
Sensor Scheduling in Kalman Filters: Evaluating a Procedure for Varying Submarine Nav aids	
T.H. Kerr III, <i>TeK Associates</i>	310
Pressure and Blanchard Altitudes Computed from Atmospheric Data Gathered from May through July 2000 at White Sands, New Mexico	
T.-C. Li, D.N. Thunborg (retired), <i>Northrop Grumman (Litton) Guidance & Control Systems</i>	325
An Efficient Integration Scheme for the INS and the Attitude Determination GPS Receiver	
S. Heon Oh, D.-H. Hwang, S. Jeong Lee, <i>Chungnam National University, South Korea</i>	334
 SESSION B2a: MARITIME NAVIGATION	
Support System for Economical Navigation in Inland Seas by Using Current and Wind Information	
K. Murai, Y. Hayashi, <i>Kobe University of Mercantile Marine, Japan</i>	341
LORAN-C Recapitalization Project (LRP) – Summer 2001 Update	
A.N. Arsenault, J.M. Boyer, <i>United States Coast Guard</i>	346
A High Accuracy Hybrid Navigation System for Unmanned Underwater Vehicle	
H. Kumagai, <i>Ritsumeikan University/Tamagawa Seiki. Co., Ltd, Japan</i> ; M. Kihara, Y. Kubo, S. Sugimoto, <i>Ritsumeikan University, Japan</i>	356
USCG Tender Deployable Differential Reference Station	
D.B. Wolfe, D.J. Godfrey, R.W. James, <i>United States Coast Guard Command and Control Engineering Center</i>	364

Coverage Analysis of NDGPS Broadcast Sites D.B. Wolfe, D. Ojeda, D.J. Godfrey, J.L. Hartline, E.B. Manley, <i>United States Coast Guard Command and Control Engineering Center</i>	370
--	-----

SESSION B2b: ATMOSPHERIC EFFECTS ON NAVIGATION SYSTEMS

Ionospheric Correction Improvements for Single Frequency GPS Receivers A. Brown, A. Jovancevic, S. Ganguly, M. Kirchner, S. Zigic, <i>Center for Remote Sensing, Inc.</i>	376
Benefits of GPS Modernization to the Atmospheric Science Community A.J. Van Dierendonck, <i>AJ Systems</i> ; A.J. Coster, <i>MIT Lincoln Laboratory</i>	382
Measuring Ionospheric Scintillation Effects from GPS Signals A.J. Van Dierendonck, <i>AJ Systems</i> ; Q. Hua, <i>GPS Silicon Valley</i>	391

SESSION C2: LAND, MOBILE, E911, TELECOMMUNICATIONS, & INTERNET APPLICATIONS OF GPS

A Low Cost and Simple Approach for Driver Navigation H. Agnew, V. Geake, C. Beatty, <i>Yeoman Group plc, England</i>	397
Low-Cost Automotive Navigation Alternatives D.N. Aloj, J. Stefan, <i>OnStar</i>	402

SESSION D2: ALGORITHMS AND METHODS FOR NAVIGATION SYSTEMS

Real-time Minimization of the Total Tracking Error in Phase and Delay Lock Loops – A Second Approach of the Fast Adaptive Bandwidth Algorithm F. Legrand, C. Macabiau, <i>ENAC, France</i>	408
The Impact of Proposed Pseudolite's Signal Structure on the Receiver's Phase and Code Error I.F. Progri, W.R. Michalson, <i>Worcester Polytechnic Institute</i>	414
Carrier Phase Processing Without Integers J.L. Farrell, <i>VIGIL Inc.</i>	423
Extended Kalman Filter Solution for Multiple Hydrophone Position Calibration H.S. Wassaf, <i>Lucent Technologies</i> ; H.J. Rome, <i>U. Mass Lowell</i>	429
A New Attitude Algorithm for the INS Using Ring Laser Gyros Y. Teng, M. Guo, Q. Liu, H. Yang, Y. Zhang, <i>Tsinghua University, P.R. China</i> ; J. Li, <i>Bashan Instrument Factory, P.R. China</i>	444
Solutions of GPS Measurements by the Fixed-Point Iteration Technique S. Lim, <i>Inha University, Korea</i>	449

An Investigation of the Pseudolite's Signal Structure for Indoor Applications I.F. Progni, J.M. Hill, W.R. Michalson, <i>Worcester Polytechnic Institute</i>	453
--	-----

SESSION B3: NAVIGATION RECEIVER TECHNOLOGY

Real Time Verification of Bit-Cell Alignment for C/A Code Only Receivers J. Hill, W.R. Michalson, <i>Worcester Polytechnic Institute</i>	463
--	-----

Multipath Characterization Using Digital Phased Arrays A. Brown, N. Gerein, L. Savage, <i>NAVSYS Corporation</i>	469
--	-----

Measuring Interchannel Bias in GPS Receivers G. Johnson, T. Zaugg, <i>Raytheon</i>	477
--	-----

A Novel Approach to Enhancing the Sensitivity of C/A Code GPS Receivers P.A. Dafesh, T. Fan, <i>The Aerospace Corporation</i>	481
---	-----

Open Architecture GPS Receiver A. Jovancevic, A. Brown, S. Ganguly, M. Kirchner, S. Zigic, <i>Center for Remote Sensing, Inc.</i> ; L. Scott, <i>LS Consulting Inc.</i> ; P. Ward, <i>NAVWARD GPS Consulting</i>	489
---	-----

Combating Digitizing Errors in GNSS-Receivers A.J.R.M. Coenen, <i>Delft University of Technology, The Netherlands</i>	501
---	-----

SESSION C3: SPACE-BASED & REGIONAL AUGMENTATION SYSTEMS

Ionospheric Threat Model Methodology for WAAS J. Blanch, T. Walter, P. Enge, <i>Stanford University</i>	508
---	-----

Trade Study of Improvements to the WAAS Ionospheric Integrity Function for GNSS Landing System (GLS) R. Lejeune, M.B. El-Arini, <i>The MITRE Corporation/CAASD</i> ; E. Altshuler, <i>Raytheon Company</i> ; T. Walter, <i>Stanford University</i>	514
---	-----

A Prototype 3-Frequency SBAS Receiver and Test Results D.M. Akos, K. Gromov, T. Walter, P. Enge, <i>Stanford University</i>	522
---	-----

High Speed LORAN-C Data Communications - June 2001 Update B. Peterson, K. Dykstra, <i>Peterson Integrated Geopositioning, LLC</i> ; P. Swaszek, <i>University of Rhode Island</i> ; J.M. Boyer, <i>United States Coast Guard</i>	530
---	-----

SESSION A4: TESTING OF ADVANCED NAVIGATION SYSTEMS

Demonstration of NATO Standard, STANAG 4572: A Standardised Open System Architecture Interface to Enable Simulator Testing of Integrated GPS/Inertial Navigation (IN) Equipment

J. Stevenson, *Royal Air Force, UK*; S.L. Saks, *Aerospace Corp*; N. Boasman, *Defence Research Agency, UK*; G. Ramsay, *BAE SYSTEMS* 547

GPS Satellite Simulator Validation Testing for the GPS JPO

S. Green, *GPS JPO/U.S. Navy*; C. Stroing, *U.S. Navy, SPAWAR Systems Center*, E. Weston, *U.S. Navy, Naval Air Warfare Center*, B. Wheaton, *GPS JPO* 556

Advanced GPS Hybrid Simulator Architecture

A. Brown, N. Gerein, *NAVSYS Corporation* 564

Validation of IEC 2400 GPS Simulator for High Dynamic RTK Applications

K.B. Anthony, S.A. Mirsky, *USAF, 46th Test Wing/TWS* 572

Testing an Integrated INS/GPS/GPWS

K. Sheard, *BAE SYSTEMS, UK*; B. Lenett, *Honeywell International* 579

GPS Signal Degradation Analysis Using a Simulator

G. MacGougan, G. Lachapelle, M.E. Cannon, G. Jee, *University of Calgary, Canada*; M. Vinnins, *Defence Research Establishment Ottawa, Canada* 586

Further Critical Perspectives on Certain Aspects of GPS Development and Use

T.H. Kerr III, *TeK Associates* 592

SESSION B4: MILITARY NAVIGATION SYSTEMS

Development of a Small Precision FOG IMU

R. Valeri, E. Arnn, *Raytheon*; I. Humphery, C. Reynolds, *Fibersense Technology Corporation* 609

Impact of Mechanical Vibrations on the Performance of Integrated Navigation Systems and on Optimal IMU Specification

J. Wendel, G.F. Trommer, *University of Karlsruhe, Germany* 614

SUO/SAS Geolocation

Land Navigation Using Multiple Integrated Sensors

E. Jacobson, T. Lee, C. Popeck, *Rockwell Collins*; M. Martorana, *ITT*; S. Sokolowski, *CECOM* 622

Development of a Tactile Accessory to Provide Non-Visual Haptic Navigation: Initial Results

J. Kelly, M. Bousselot, J. Meyer, S. Phelps, T. Larson, *Rockwell Collins International* 634

Burn-Out, A Rational Requirement Formulation for Military GPS User Equipment

R.W. Mahoney, S.L. Saks, G.M.. Shaw, *The Aerospace Corp.*; K.A. Fromm, *ARINC, Incorporated*; R.M. Reinhart, *Centurion Wireless Technologies, Incorporated* 642

SESSION C4: GROUND-BASED AUGMENTATION SYSTEMS

NDGPS Network Enhancements in FY01

L.W. Allen, *United States Coast Guard Navigation Center*, D.B. Wolfe, C.L. Judy, E.J. Haukkala, R.W. James, *United States Coast Guard Command and Control Engineering Center* 652

Test Results and Modeling of Military GPS Landing System Guidance Quality and Availability

I. Gallimore, J. Hansen, *Sierra Nevada Corporation* 661

Development of Local Area Augmentation System Siting Criteria

D. Lamb, *FAA William J. Hughes Technical Center* 669

Integrity Design and Updated Test Results for the Stanford LAAS Integrity Monitor Testbed

G. Xie, S. Pullen, M. Luo, P.-L. Normark, D. Akos, J. Lee, P. Enge, *Stanford University*, B. Pervan, *Illinois Institute of Technology* 681

LAAS Sigma-Mean Monitor Analysis and Failure-Test Verification

J. Lee, S. Pullen, G. Xie, P. Enge, *Stanford University* 694

Preliminary Analysis of Requirements for CAT IIIB LAAS

C.A. Shively, *Center for Advanced Aviation System Development, The MITRE Corporation* 705

SESSION D4: COMPONENTS & MICROMECHANICAL SENSORS FOR INERTIAL NAVIGATION SYSTEMS & THEIR INTEGRATION

GPS/INS - A Very Different Way

F. van Graas, *Ohio University*; J.L. Farrell, *VIGIL, Inc.* 715

The Key to Unlocking the Emerging Market for Civil (and DoD) Applications of Navigation Technology: Cost Scalable Interface Standardization

A. Tetewsky, A. Soltz, T. Bogner, E. O'Neil, *The Charles Stark Draper Laboratory, Inc.* 722

Femtosecond Optical Parametric Oscillator Gyro

X. Meng, J.-C. Diels, *University of New Mexico* 733

Adapting an Open-Loop MEMS Accelerometer for Gun-Launched Navigation

J. Cole, A. Cunningham, *Silicon Designs, Inc.*; J. Tauscher, *Microvision, Inc.* 737

Advanced Spinning-Vehicle Navigation - A New Technique in Navigation of Munitions

J.H. Doty, *Rockwell Collins, Inc.* 745

Active Solid State Short Pulse Laser Gyroscope

T.T. Dang, A. Stintz, J.-C. Diels, *The University of New Mexico*; Y. Zhang, *Tsinghua University, P.R. China* 755

Investigation on the High Frequency Readout System for Dithering Ring Laser Gyros
M. Guo, H. Yang, Y. Teng, Y. Zhang, *Tsinghua University, P.R. China* 765

SESSION A5: SURVEYING, GEODETIC, MAPPING, & REMOTE-SENSING APPLICATIONS USING GPS

Availability Aspects of a Terrain Database Integrity Monitor
J. Campbell, M. Uijt de Haag, *Ohio University*; R. Gray, *Penn State University* 770

Space-Borne GPS Receivers for Remote Sensing of the Ionosphere and the Troposphere
S. Ganguly, A. Brown, A. Jovancevic, M. Kirchner, S. Zigic, *Center for Remote Sensing, Inc.* 778

Static Azimuth Determination Using a Single Handheld GPS Receiver
J. Kelly, E. Bogensberger, E. Rammelsberg, *Rockwell Collins International* 790

SESSION B5: RANGE, REMOTE POSITIONING & TRACKING APPLICATIONS USING GPS

GPS Network Implementation for Missile Defense Testing
A.W. Sutter, J.P. Cunningham, *Naval Surface Warfare Center, Dahlgren Division* 797

A Space Based Internet Protocol System for Launch Vehicle Tracking and Control
B. Bull, D. Morgan, *NASA, Goddard Space Flight Center*; C. Grant, R. Streich, *NASA, Computer Sciences Corporation* 809

Development of the GPS-Based Ballistic Missile Range Safety Technology (BMRST) System
C. Nesbit, D. Huff, *Honeywell International*; S. Croopnick, *Draper Laboratories*;
R. Ostroff, *ENSCO, Inc.*; C. Bartone, *Avionics Engineering Center, Ohio University*;
S. Slivinsky, *Air Force Research Laboratory*; C. Wilborn, *Aero Thermo Technology, Inc.*;
R. Schoefield, *Florida Air National Guard* 816

A Portable Impact Location System
D. Guilford, *Palisades Geophysical Institute, Inc.*; M.A. Cardoza, *Applied Research Laboratories: The Univ. of Texas at Austin* 823

Aircraft Flight Evaluation of a Ballistic Missile Range Safety Technology (BMRST) System
C.G. Bartone, A. Wilson, *Avionics Engineering Center, Ohio University*, C. Nesbit, *Honeywell International*, R. Phillips, *Draper Laboratory*; R. Rexrode, *ENSCO, Inc.* 829

SESSION C5: MILITARY PRECISION APPROACH & LANDING SYSTEMS

Test Results of an F/A-18 Automatic Carrier Landing Using Shipboard Relative GPS
J. Waters, *USN*; P. Sousa, L. Wellons, G. Colby, *Naval Air Systems Command*;
J. Weir, *J.F. Taylor, Inc.* 841

Guidance and Control for Shipboard Automatic Landing Using GPS
E.C. Schug, J.W. Aksteter, *Scientific Applications International Corporation*; R.W. Huff,
Sierra Nevada Corporation; M.P. Smith, *U.S. Navy* 852

Use of Inertial Reference Data to Support Differential GPS for Carrier Landing
C.P. Bruner, *Northrup Grumman Corporation, Litton Guidance & Control Division*;
R.W. Breslau, *Consultant to the Naval Air Weapons Center* 863

**Test Results from a Digital P(Y) Code Beamsteering Receiver
for Multipath Minimization**
A. Brown, N. Gerein, *NAVSYS Corporation* 872

Test Results of an F/A-18 Automatic Carrier Landing Using Shipboard Relative GPS

LCDR Jack Waters, USN
Paul Sousa, Lee Wellons, and Glenn Colby, Naval Air Systems Command
John Weir, J.F. Taylor, Inc.

BIOGRAPHIES

Lieutenant Commander Jack Waters is currently the Carrier Suitability and Approach Landing Systems Department Head of the Naval Strike Aircraft Test Squadron at Naval Air Station Command Patuxent River, Maryland. As a test pilot for the Navy, he flies both the F/A-18 Hornet and Super Hornet aircraft, and has served as project test pilot for development of JPALS.

Paul Sousa is an aerospace engineer for the Naval Air System Command at Patuxent River, Maryland. He received his BS in Aerospace Engineering from the University of Maryland in 1996. He has performed test and evaluation on aircraft approach and landing systems. He is currently the NAWCAD lead test engineer for the development of the SRGPS system.

Lee Wellons is a senior engineer and GPS based landing system expert for the Naval Air Systems Command at Patuxent River, Maryland. He received a BS in Aerospace Engineering from North Carolina State University in 1989 and an MS in Electrical Engineering from Ohio University in 1994. He has worked in the Air Traffic Control and Landing Systems Branch at Patuxent River since 1989 concentrating on U.S. Navy shipboard landing systems and GPS applications.

John Weir is Chief Scientist for J.F. Taylor, Inc in Lexington Park, MD supporting the Naval Air Systems Command at the Naval Air Station Patuxent River, Maryland. He received his B.S. (1969) from the University of Massachusetts at Amherst, and Ph.D. (1974) from the University of Washington, both in Physics.

Glenn Colby is the Satellite Navigation and Air Traffic Control (SATNAV/ATC) Team Leader for the Naval Air Systems Command at Patuxent River, MD. He represents

the Department of Defense at the International Civil Aviation Organization (ICAO) Global Navigation Satellite System Panel (GNSSP), several NATO committees, the FAA's Satellite Operational Implementation Team (SOIT), and a number of other industry and government groups. He is currently the Chief Engineer for the Navy's JPALS effort. He received his BS in Aerospace Engineering from the University of Virginia in 1984.

ABSTRACT

Under the U.S. Department of Defense's Joint Precision and Landing System (JPALS) program, the Navy is responsible for developing the shipboard component, termed Shipboard Relative GPS (SRGPS). As part of the SRGPS effort, a test bed was developed to demonstrate air traffic control, navigation, and landing capabilities in the carrier environment. During flight testing from January through April, 2001, the Navy conducted automatic landings to the USS Theodore Roosevelt (CVN-71) using an F/A-18A Hornet test aircraft. These tests represented several firsts in the history of GPS.

In January 2001:

- First ever GPS-based precision approach to a US Navy ship (first to any ship by a tactical aircraft),
- First ever GPS-based automatic low approaches to any ship,
- First ever 3-dimensional GPS guided approaches to any ship, and
- First real time demonstration of GPS centimeter level relative accuracy during shipboard approaches.

In April 2001:

- First ever GPS-based automatic landings at sea.

The airborne segment of the SRGPS combined the uplinked GPS data from the ship with data from the

aircraft's onboard GPS receiver to compute a highly accurate Relative Kinematic Carrier Phase Tracking (RKCPT) solution. The airborne SRGPS guidance and control processor blended the RKCPT position solution with data from the aircraft's Inertial Navigation System (INS) and the shipboard's Ship Motion Sensor (SMS) to compensate for deck motion and to compute glidepath deviations. The system then provided autopilot commands to the aircraft relative to the ship's stabilized glidepath, allowing fully automatic precision approaches and landings.

This paper will describe the overall SRGPS test effort. The paper will also give an overview of the test bed hardware, as well as results for navigation sensor error, flight technical error and total system error. The test and analysis results support the feasibility of the GPS based precision approach and landing system concept.

INTRODUCTION

JPALS is a revolutionary, next generation, precision approach and landing system under development by the Department of Defense (DoD). JPALS includes both the sea-based variant, SRGPS - which provides precision navigation and two-way Air Traffic Control (ATC) for sea-based aircraft operations - as well as the local differential systems for providing precision landing capability ashore. The SRGPS supports all ATC functions including takeoff, departure, taxi, marshal (holding), approach, landing, bolter, missed approach, and long-range navigation as shown in figure 1. SRGPS is compatible with Naval Emissions Control (EMCON) requirements and the associated avionics provide complete interoperability with DoD, Allied, and civil navigation systems. In addition to supporting manned aircraft, SRGPS fully supports automatic takeoff, departure, approach, landing, and ATC automation required by future unmanned systems such as the Naval Unmanned Combat Air Vehicle (UCAV).

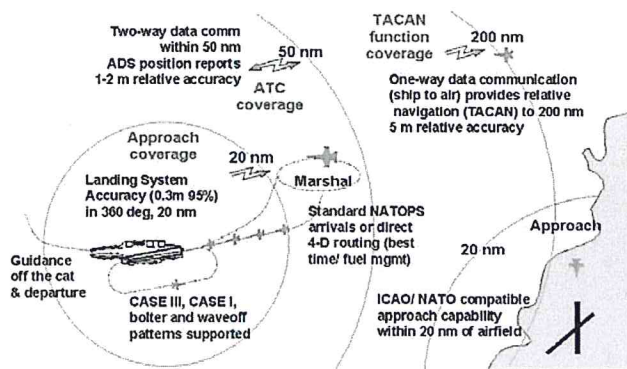

Figure 1 – SRGPS Concept

SRGPS shares some basic concepts with local differential GPS systems used ashore (such as the FAA's Local Area Augmentation System – LAAS), but with a few important differences. Any local differential DGPS system relies on the fact that relative measurements between two GPS receivers in the same local geographic area can be made very accurately. When the solutions of two receivers utilizing the same satellites are compared, common mode errors such as satellite clock, satellite ephemeris (orbit errors), atmospheric transmission errors, generally cancel out. This comparison of two GPS receiver's measurements of one satellite is termed a *single difference*. Since one ground system is meant to serve multiple aircraft, a technique was developed where the ground system broadcasts *differential corrections* to all aircraft. Each aircraft uses only those corrections that correspond to valid satellite measurements in its own receiver. In addition, these corrections would be made to a surveyed point, resulting in not only an accurate relative solution, but also an accurate absolute position (in the GPS coordinate frame, WGS-84). To use this accurate position for navigation, the glide path (defined by a set of path points) and waypoint data is sent to the aircraft via the data broadcast.

In the SRGPS concept, the "reference station" is installed on a ship instead of a fixed surveyed point in the WGS-84 coordinate frame. The GPS antenna location(s) aboard ship are precisely surveyed in the ship body axis relative to the inertial system locations, the ship's center of motion, and the aircraft touchdown point. This ensures that accurate relative vectors are maintained as the ship translates through the water, pitches, rolls, and yaws around its center of motion. In addition the center of motion itself may translate up/down (heave); side to side (sway), and fore and aft (surge). Any location away from the center of motion (such as the GPS antenna location, or aircraft touchdown point) will experience additional heave, sway, and surge due to the lever arm effect. Despite this motion, a single difference calculation between a ship antenna and aircraft antenna can be made just as accurately as its shore based counterpart. The primary difference is simply that the differential correction technique is not used, since absolute positioning accuracy is not required.

Instead of a correction, the shipboard GPS system transmits whole satellite measurements to the aircraft and the aircraft directly compares aircraft and ship solutions based on a common set of satellites. This method produces an accurate relative vector between the two antenna locations, which are further translated to the ship and aircraft centers of motion and the reference flight path points. For tailhook equipped aircraft, the hook point is intended to touchdown halfway between the second and third arresting gear wires on the ship. These translations

are made through the use of precision Inertial Navigation System (INS) measurements on the ship and the aircraft.

In addition, unlike the shore approach, the ship flight path is calculated in a dynamic fashion. The approach path is stabilized for ship motion until approximately 10 seconds (0.3 nautical miles) from touchdown. At this point, the aircraft is commanded to follow the touchdown point sway and heave motions during the final portion of the approach. This portion of the approach is termed the Deck Motion Compensation (DMC) phase. The aircraft is controlled in reference to an approach heading that is based on a filtered cant deck heading to allow for ship turns and yaw motions during the aircraft's approach.

The safe landing area aboard ship is much smaller than runways at major airports. Aircraft landing off centerline by more than 3 meters (~10 ft) laterally can result in the aircraft's wingtip being dangerously too close to obstructions on the flight deck. The aircraft's hook path over the end of the landing area, termed the hook to ramp clearance, is only 4.3 meters (~14 ft). The most demanding requirement for a shore based LAAS system is 2 meters (~6.5 ft) of vertical navigation system error to accomplish an automatic landing. Aboard ship, 2 meters of vertical error would result in an unsafe landing condition. The SRGPS requires 0.4 meters (~1.3 ft) vertical error to accomplish a safe automatic landing. Figure 2 shows a 1.5 sec time lapse of an aircraft arrestment, showing both the wire locations and the ideal touchdown point.

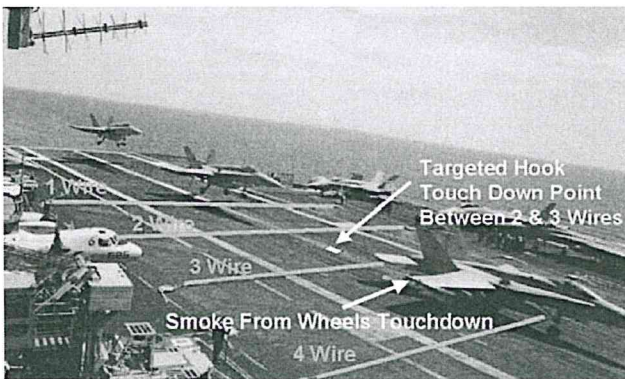

Figure 2. Aircraft Carrier Landing

To meet the requirement for shipboard landings, further refinements to the standard single difference technique were made. A double difference calculation is made where all satellite measurements at both receivers are also compared against a key satellite. The double difference solution is smoothed in a Kalman filter and the resulting solution is termed the float solution. From this float solution a carrier phase integer ambiguity determination is made using the LAMDA method developed by Teunissen, reference 1.

SYSTEM DESCRIPTION

Figure 3 shows the relationship of the various SRGPS system hardware components.

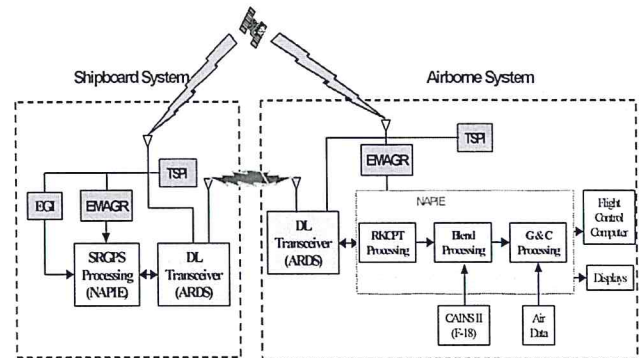

Figure 3 – SRGPS Hardware Diagram

Naval Avionics Platform Integration Emulator

The Naval Avionics Platform Integration Emulator (NAPIE) is designed to facilitate rapid prototyping and development of new avionics concepts. In generic form, the NAPIE installation consists of a rugged commercial-off-the-shelf computer, a data recorder, an interface to the host-aircraft's avionics busses, and an interface to the system under test. NAPIE is designed to emulate devices in the host aircraft, thus allowing prototype equipment to be integrated into the aircraft in a production-representative fashion. NAPIE eliminates the need to modify the operational software of the existing host aircraft mission computer. Changes to the cockpit displays and flight controls (external to the aircraft's Flight Control Computer) can be made through NAPIE, thus cutting the time and expense that would otherwise be required to support an early flight-test demonstration or system development program.

For this test effort there were two NAPIE computer systems used. The airborne unit hosted the system operation, control and display, RKCPT, and guidance and control algorithms. The shipboard NAPIE hosted the Ship Motion Sensor (SMS) algorithms and pre-processed shipboard GPS data for uplink to the aircraft.

Enhanced Miniaturized GPS Airborne Receiver

The Enhanced Miniaturized Airborne GPS Receiver (EMAGR) from Rockwell Collins was the primary GPS sensor used in the SRGPS airborne and shipboard subsystems. The EMAGR, shown on the left in figure 4, is a 24-channel (12 L1 channels and 12 L2 channels) GPS receiver designed for airborne applications. The EMAGR provided the SRGPS system with raw Y-code pseudorange and carrier phase data, all in view, for both L1 and L2 frequencies simultaneously. EMAGR output messages received by SRGPS (airborne and shipboard) were recorded for post flight analysis. The quality of the SRGPS position solution critically depended on the

quality of the data provided by the EMAGRs. Aboard ship the data quality was primarily affected by the type and location of the shipboard antenna.

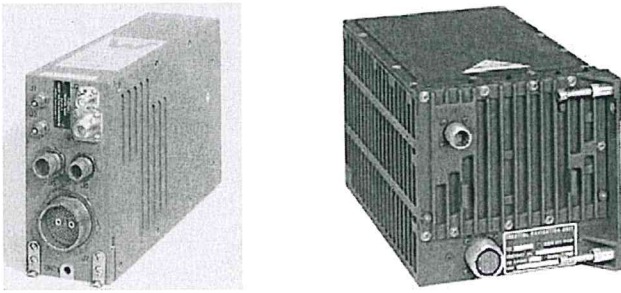

Figure 4 – Rockwell EMAGR and Litton EGI

Embedded GPS INS (EGI) Navigation Unit

The inertial sensor used in the shipboard sub-system was the Litton AN/ASN-172 EGI, (figure 4, right), which is a strap-down inertial navigation system. The EGI is composed of inertial navigation components and a GPS receiver housed in the same chassis, using a common power supply. The EGI provides both free inertial navigation outputs and outputs whose errors are bounded by the outputs from the GPS receiver (see reference 2). The free inertial performance is classified as medium accuracy (0.8 nm/hr drift rate and velocity errors of 2.5 feet/sec). The blended output has a stated accuracy of 10 meters or better with velocity accuracy of better than 0.05 feet/sec.

The inertial components include three orthogonally mounted Zero Lock Gyros® and three orthogonally mounted accelerometers. The GPS receiver is a five channel single module that is fully militarized and capable of receiving both L1 and L2 GPS signals and can operate on C/A, P, and Y codes. The EGI is mechanized with two separate redundant MIL-STD-1553 busses, one of which is solely for independent GPS operation. The primary bus provides communication with both the inertial navigation portion of the EGI as well as the GPS receiver.

Advanced Range Data System (ARDS)

The SRGPS datalink used was a customized version of the Advanced Range Data System (ARDS) datalink system. The SRGPS datalink operated in dual-frequency mode in L-band in the range 1350-1400 MHz or at the discrete frequency of 1433 MHz. The transmitter power was nominally 80W, and the range was approximately 90 nautical miles. The datalink used a TDMA (Time Division, Multiple Access) architecture.

The baseline ARDS configuration consisted of a ground segment and air segment. The ground segment comprised an L-Band datalink antenna, a Data Link Transceiver (DLT), a Ground Station Interface Unit (GSIU), a Data Link Control/Data Link Processor (DLC/DLP) computer,

and a PC display station. The air segment consisted of an L-Band datalink antenna, a Data Link Transceiver (DLT), and an Advanced Digital Interface Unit (ADIU) that interfaced to NAPIE and the aircraft data system.

Antennas

Three Fixed Radiation Pattern Antenna (FRPA) L1/L2 GPS antennas were used: a standard Navy shipboard antenna AS-3819, a Sensor Systems antenna mounted on a flat ground plane and a MicroPulse antenna with an integral choke ring ground plane. Figure 5 shows these three antennas in order from left to right and their locations as mounted on the upper yardarm of the ship. During shipboard testing, data was collected from all three antennas with the choke ring antenna used as the primary antenna for the majority of the flight-testing. Each antenna used the same Delta Microwave GPS Diplexer/Amplifier.

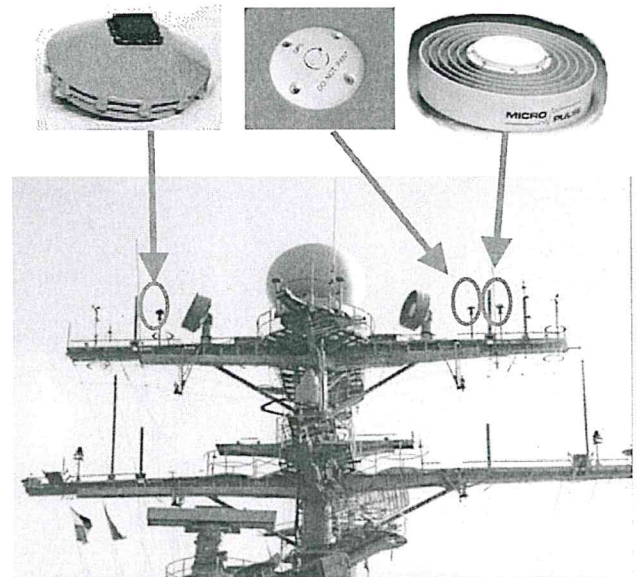

Figure 5 – Shipboard GPS antenna installation

Time Space Position Information

Raw NovAtel L1/L2 GPS data was taken on both the ship and aircraft for post flight comparison to the SRGPS data. On the aircraft, the NovAtel was connected to the same GPS preamp output as the SRGPS. On the ship, the NovAtel was connected to the same GPS preamp output for the antenna that was being used for a particular flight test event.

SRGPS Test Aircraft

A single F/A-18A was the test vehicle for the SRGPS demonstration. The F/A-18A is a single-place fighter/attack aircraft, which incorporates an Automatic Carrier Landing System (ACLS) auto-land capability currently in use by the fleet. The specific aircraft for these tests was a Lot 9 F/A-18A, from the Naval Strike Aircraft

Test Squadron (NSATS) designated SD110 (BuNo 163148) at the Naval Air Systems Command (NAS) Patuxent River, Maryland. The test aircraft with modifications and instrumentation was otherwise fleet representative.

Airborne Integration

Modifications to the aircraft included an instrumentation pallet, containing all aircraft SRGPS/NAPIE hardware, which was loaded in the test aircraft's gun bay. Externally, two L-band data link antennas were installed – one on the “turtleback” behind the canopy, and one on the “chin” of the aircraft. A standard Navy Dorne & Margolin L1/L2 FRPA GPS antenna was installed in the aircraft's turtleback in the same location as in the production F/A-18C/D's. Figure 6 shows the location of the SRGPS equipment on the flight test aircraft, the instrumentation pallet, and the pallet being uploaded for flight. A particularly useful feature of the system integration was that once the instrumentation pallet was loaded on the aircraft, all interfaces were accessible through the gun access door as can be seen in the lower right picture of figure 6. Removable PCMCIA flash memory cards were accessible through this door and were used both for software upload as well as data recording.

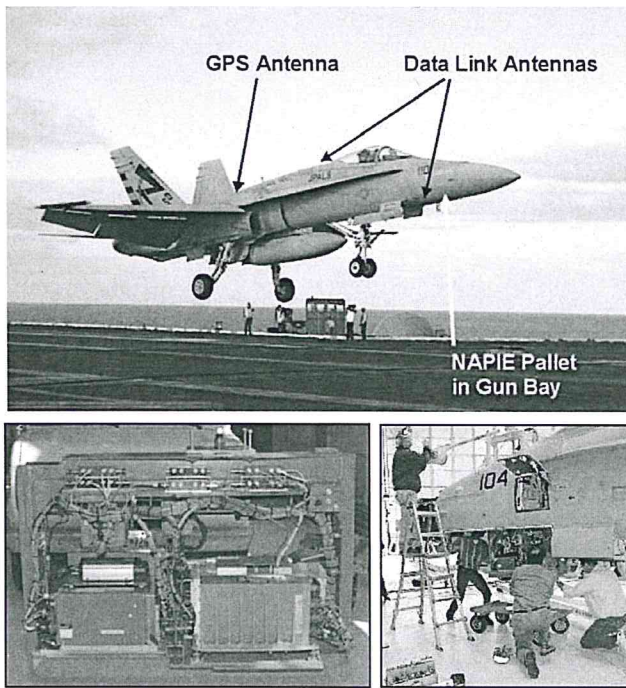

Figure 6 – F/A-18 Installation & SRGPS Pallet

The NAPIE computer was mounted on an F/A-18 instrumentation pallet, and interfaced with the host-aircraft avionics through a network of 1553 bus relays. The bus relays either isolate NAPIE or place NAPIE “in the loop” between the Mission Computer and the host avionics. The pilot could isolate the NAPIE system from

the aircraft system at any time in flight through a master switch for all bus relays, which returns the aircraft to the normal production aircraft configuration. This installation is made fail-safe by ensuring the bus relays always fail to the NAPIE “isolate” position. Figure 7 shows the SRGPS/NAPIE airborne hardware integration in the aircraft.

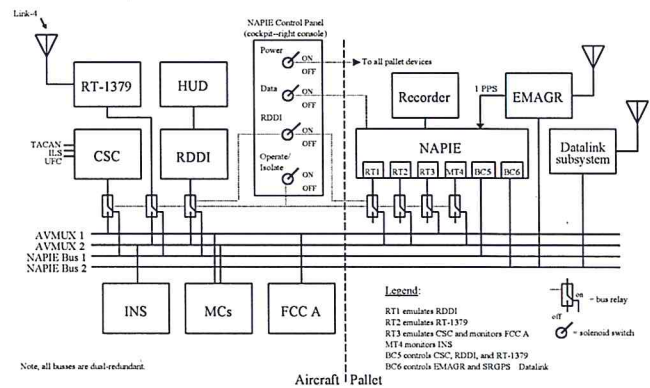

Figure 7 – Aircraft/Instrumentation Pallet Diagram

NAPIE emulated the production Automatic Carrier Landing System (ACLS) RT-1379 datalink radio in order to send guidance information and autopilot commands based on the SRGPS solution to the F/A-18 Mission Computer. Similarly, NAPIE also emulated one of the cockpit displays - the Right Digital Display Indicator (RDDI) - for pilot control and display of system performance parameters. One of the NAPIE RDDI pages is shown in figure 8.

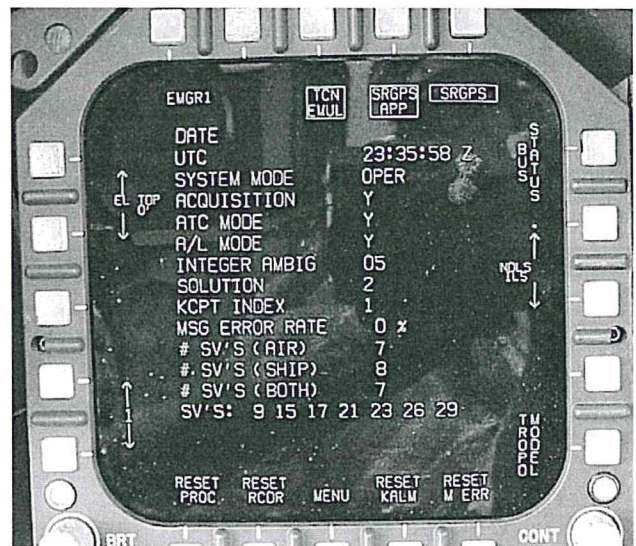

Figure 8 – NAPIE Emulated RDDI

In addition to the cockpit displays, NAPIE overdrove the Head Up Display (HUD) in the aircraft with SRGPS symbology.

SRGPS initially used the same guidance symbology as ACLS. Flight path deviations are depicted graphically on the HUD as a tadpole symbol (⊖) referenced to a velocity vector symbol (⊖) as shown in figure 9. The horizontal and vertical position of the tadpole relative to the velocity vector corresponds to the horizontal and vertical deviations from the programmed flight path. For example, a tadpole above and to the right (as shown in the illustration below) of the velocity vector meant that the aircraft was below and to the left of the programmed flight path. Tadpole deflections represented angular deviations from flight path and were scaled linearly throughout the tadpole's range. A full-scale horizontal deflection corresponded to a horizontal deviation of 6.0° or greater. A full-scale vertical deflection corresponded to a vertical deviation of 1.4° or greater.

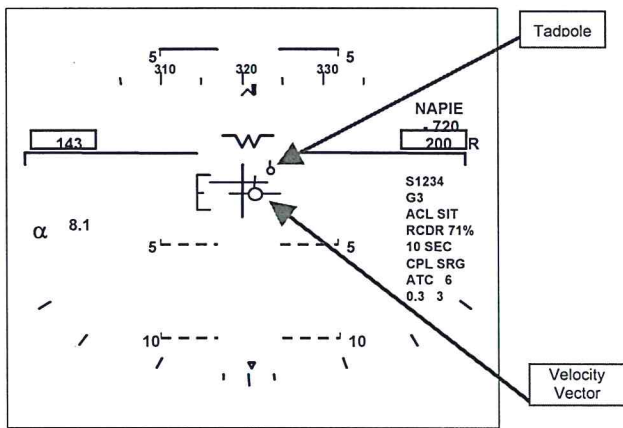

Figure 9 – SRGPS/NAPIE Head Up Display Illustration

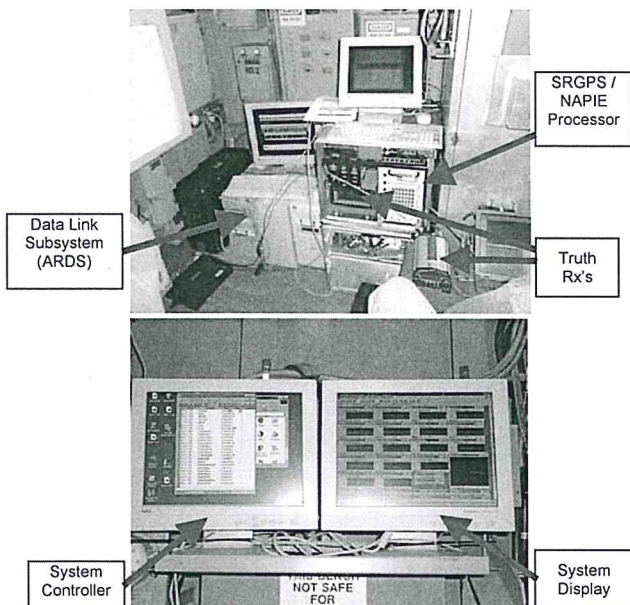

Figure 10 - SRGPS Shipboard Station

In addition to the tadpole situation display, the SRGPS was also capable of driving a flight director display described in more detail in reference 3.

Shipboard Integration

The SRGPS shipboard station consisted of a ARDS two-way L-band data link transceiver, an EMAGR, a Time Space Position Information (TSPI) truth receiver, an EGI, a real-time controller and a system performance parameters display with NAPIE as the central processor, as shown in figure 10.

The ground station collected, processed, and up linked the GPS wide-lane data, ship motion and stabilization measurements to the airborne system as shown in the functional diagram, figure 11. For additional information on the guidance and control processing used for SRGPS testing, see reference 3.

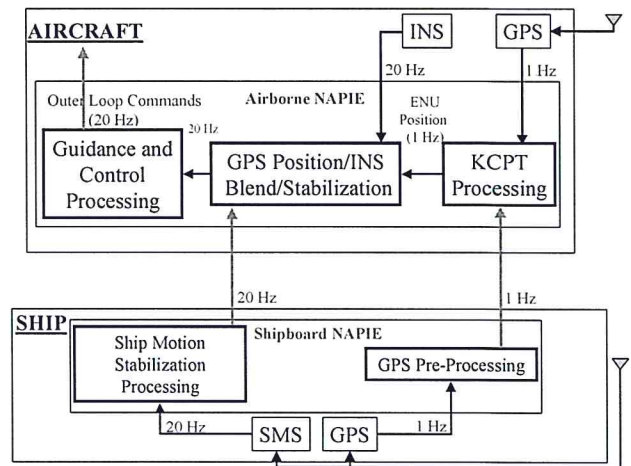

Figure 11 - SRGPS Functional Diagram

SCOPE / METHOD OF TEST

A total of 19 flights and 23.1 flight hours were flown during a three-month period between 30 January and 27 April 2001. Shore based testing was conducted at NAS Patuxent River, Maryland, and shipboard testing was conducted aboard the aircraft carrier USS Theodore Roosevelt (CVN-71) underway in the Atlantic Ocean.

Prior to at sea testing, initial test flights of the SRGPS system were flown ashore. A total of 8 flights ashore totaling 8.3 hours were flown to verify, assess and improve system performance; to test and modify various guidance and control law gains; to evaluate aircraft open and closed loop response to SRGPS commands; and to test control volume and control limiters in aircraft pitch and roll.

The external loading of the aircraft was limited to one configuration of a single 330-gallon external fuel tank

mounted under the aircraft along the centerline. No other external stores or pylons were used during test flights. The intent was to limit the aircraft's configuration to a well-defined aerodynamic and inertial model, one well supported with historical performance data.

Both manual and automatic SRGPS approaches were flown during tests. Manual approaches were flown with the pilot following SRGPS commands displayed in the head up display. Once satisfactory performance was observed during manual approaches, subsequent approaches were flown with the aircraft's autopilot engaged to follow SRGPS commands. Initial automatic approaches were first flown to elevated touchdown points safely between 100 and 400 feet above the ground and/or ship where the touchdown point was moved up along the glide path. Additionally, Mode IA (manual takeover at 200 ft above touchdown) approaches were conducted to verify system alignment with the touchdown point. It was not until at least one of each of these approaches demonstrated satisfactory SRGPS performance, that automatic approaches to touchdown on the runway or flight deck were performed. Each software change effecting guidance and control required the same buildup for safety.

All automatic SRGPS approaches at sea were flown with the aircraft's arresting hook up to avoid the risk of in-flight hook engagement of the arresting gear in case pilot takeover was necessary over the wires. During SRGPS testing at sea, changes in aircraft attitude were unremarkable and pilot takeover could be managed during all test conditions. Based on the effectiveness of the system limiters and the ability for pilot takeover, the hook-up test safety requirement will be re-examined for future testing.

DATA ANALYSIS

The data collection, reduction and analysis performed during this test effort were designed to demonstrate the feasibility of shipboard approach and landing. Data analysis was also critical for the identification and correction of any noted system anomalies or deficiencies. For each test, analysis began by assessing the performance of sensors that were integrated into the SRGPS system. The post-processed GPS TSPI data were assessed to determine its suitability as a baseline against which the SRGPS system could be judged. In addition, the SRGPS performance was compared to the ACLS tracking during the approach. Finally, carrier landing system performance metrics were evaluated for the overall SRGPS system.

Time Space Position Information (TSPI)

For comparison to the RKCPT and blend guidance position outputs, raw NovAtel GPS data at 4 Hz was post

processed using GrafNav to generate the TSPI. Default GrafNav settings for kinematic base station and rover data with dual frequency measurements were used, and time forward, time reverse, and variance weighted combined forward-reverse solutions were saved.

Performance of this TSPI was analyzed to determine its availability and expected accuracy. Since the TSPI solution was based on the same GPS constellation as the RKCPT solution, it was expected that at times both would be showing degraded performance. For example, when the GPS satellites being tracked were affected by high angle of bank maneuvering, sometimes one or both solutions had trouble maintaining their most accurate solution (or any solution if less than 4 satellites were tracked). A significant difference in the two solutions, however, was that the RKCPT solution was calculated in real-time while the TSPI solution was post-processed. In post-processing, one may take advantage of knowing which satellites are continuously tracked for all times in the data (past, present, and future) and of processing techniques such as forward-reverse averaging. Therefore, it was expected that the TSPI solution would have better performance on average than the RKCPT solution and could be used to calculate navigation sensor errors (NSE). However, the TSPI had one significant disadvantage in tracking the P-code with a codeless technique, resulting in a lower signal to noise than the Y-code tracking of the EMAGR. In cases where the TSPI data was judged to be experiencing degraded performance, the truth data was declared unavailable and no NSE was calculated.

In addition to position and velocity of the aircraft relative to the ship, estimates of the solution accuracy (residuals), the number of satellites used in the solution, and a general quality factor were generated to support analysis of the post processed solution. For the position solution to be considered acceptable, the solution residual must have been less than 10 cm, the number of satellites used in the solution must have been 4 or more, and the quality factor must have been 2 or less (on a scale of 1 to 6 with 1 being the best). Typically, between 5 and 10 percent of the truth data was deemed to have unacceptable performance for a given approach.

Several specific differences were noted between the RKCPT solution and the post-processed forward-reverse combined NovAtel solution. These differences generally were less than 0.5 meters but at times were as large as 1 to 2 meters. When noted, these differences also existed between one of the forward or reverse processed solutions, and hence the combined solution as well. The GRAFNAV software's averaging of the two processed solutions may be very useful in other applications, but in SRGPS the averaging of these different solutions generally induced a TSPI bias in the data. For carrier phase systems, the errors are assumed to be integer

multiples of the wavelength. Theoretically, if there are two different TSPI solutions, either one of them is right and one is wrong, or they are both wrong – but both cannot be “right”. It was noted that when the TSPI solution differences did occur, the single direction solution with the lowest residual was much more consistent with the RKCPT output than the other. The fact that these relatively small differences were noticed at all highlights the relatively good performance of the real-time RKCPT solution. The fact that the exact determination of RKCPT accuracy is difficult emphasizes the challenge in demonstrating system integrity.

In addition to the NovAtel derived TSPI, SRGPS coupled approaches were also tracked with the standard shipboard precision approach radar, the ACLS - AN/SPN-46. While the stabilized coordinate frames of the SRGPS and AN/SPN-46 can be substantially different at range, the alignment converges as the aircraft nears the touchdown point. The AN/SPN-46 tracking data along with both pilot and Landing Signal Officer comments were used to corroborate the NovAtel TSPI. From these combined sources, average alignment of the SRGPS approach path was determined. Navigation Sensor Error (NSE) was calculated using the 4 Hz TSPI data and blend guidance position outputs from the SGRPS. For coupled approaches, Flight Technical Error (FTE) was also calculated.

System Performance Analysis

SRGPS performance during flights conducted on April 23 and 24, 2001 aboard the USS Theodore Roosevelt was analyzed in some detail and a portion is presented here. During these flights the Navy performed its first fully automated approach and landing to the deck of an aircraft carrier using relative GPS for guidance.

On these two days, there were a total of 17 SRGPS approaches made. Fifteen of the 17 approaches had data suitable for analysis. For 10 of these 15 approaches, automatic control was provided to touchdown on the deck. In this paper ensemble FTE and NSE results for the 10 completed approaches are presented.

Runway Coordinates

SRGPS NSE and FTE were analyzed in a cant deck (runway-oriented) coordinate system. This runway coordinate system was right-handed and orthogonal with the origin at the desired touchdown point, the x-y axis plane level with the earth at this touchdown point, and the x-axis positive aft (positive with increasing distance from touchdown).

Navigation Sensor Error Data

The SRGPS navigation sensor error is shown in figure 12. Data during the last mile of the approach are presented as typical for the entire approach. NSE's in the three runway

coordinate directions are plotted as functions of the distance of the hook from the touchdown point in nautical miles. Errors are plotted in feet, where positive (+) is up, right, and aft (this sign convention holds for all FTE, NSE, and TSE data presented).

When evaluating NSE, the SRGPS time tag and TSPI time tag were aligned. It should be noted that the SRGPS time tag was always latent 100 msec by design, based on the most recent airborne INS measurement. This latency is part of the overall control system latency but is not incorporated in the NSE measurement.

Table 1 shows the mean and standard deviations of the NSE as a function of range from touchdown. The data have been grouped into 15 bins. Each bin is 0.0667 nautical miles wide so the bins cover the range from 0 to 1 nautical miles. At the typical 200 ft/sec approach speed of the aircraft, the bins equate to approx. 2 seconds wide.

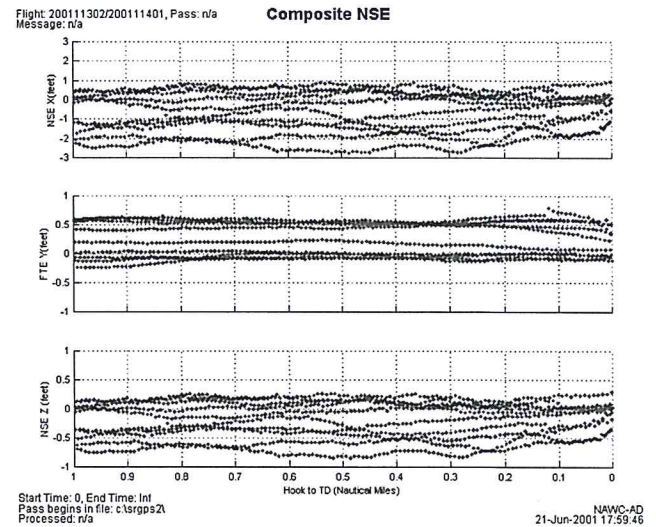

Figure 12 – Composite Navigation Sensor Error Plot

The NSE mean in the last mile was 0.26 ft in lateral (Y), -0.19 ft in vertical (Z), and -0.61 ft in longitudinal (X). Standard deviations averaged 0.28 ft in Y, 0.31 ft in Z, and 1.00 ft in X. The X direction has some residual time uncertainty, but the Y and Z direction have mean+standard deviation values of 0.55ft (17 cm) and 0.49 ft (15 cm) respectively over the last mile. At touchdown, these values are 0.50ft (15cm) and 0.35ft (11cm) for Y and Z, all of which meet the intended accuracy requirement for SRGPS. A portion of the mean and standard deviation contribution appears to be a function of the truth receiver operation as described previously; this is under investigation.

Flight Technical Error Data

Figure 13 shows composite Y and Z FTE from the automatic control system with statistics given in Table 2.

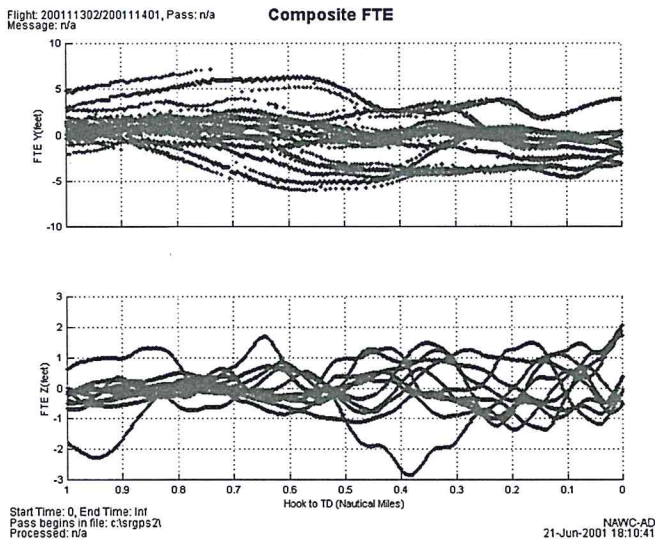

Figure 13 – Composite Flight Technical Error Plot

The SRGPS maintains very tight control during the last mile of the approach. The mean Y and Z FTE averaged over the last mile are -0.08 and -0.02 ft, with standard deviations of 2.24 and 0.68 ft respectively. This is well within the desired performance of ACLS. Note that there is some trending in the FTE data. Notice a slight trend in Z, for example, to fly through the glideslope right near touchdown in a low to high manner. Also note the tendency to move slightly left near touchdown. Since the approaches were conducted in relatively consistent wind conditions, the aircraft's response to the burble results in some trending of the FTE along the approach although the mean FTE is near zero. The burble, and the resultant trending, will be a direct function of the carrier wind-over-deck magnitude and direction.

Total System Error Data

Table 3 shows the TSE data calculated from NSE and FTE for just the lateral and vertical data (since FTE is not calculated for X). TSE standard deviation is within 2 feet for lateral and 1 foot for vertical control.

Distance from TD (nmi)	0.97	0.90	0.83	0.77	0.70	0.63	0.57	0.50	0.43	0.37	0.30	0.23	0.17	0.10	0.03
Y error mean (ft)	0.26	0.27	0.27	0.26	0.29	0.27	0.28	0.27	0.27	0.25	0.25	0.27	0.26	0.26	0.23
Y error std dev (ft)	0.32	0.32	0.30	0.29	0.27	0.27	0.27	0.27	0.27	0.27	0.28	0.29	0.29	0.30	0.27
Z error mean (ft)	-0.23	-0.21	-0.21	-0.18	-0.19	-0.18	-0.18	-0.18	-0.20	-0.20	-0.20	-0.21	-0.15	-0.15	-0.11
Z error std dev (ft)	0.31	0.30	0.30	0.31	0.30	0.32	0.33	0.34	0.35	0.32	0.34	0.31	0.26	0.26	0.23
X error mean (ft)	-0.74	-0.70	-0.69	-0.59	-0.64	-0.60	-0.60	-0.59	-0.64	-0.64	-0.67	-0.70	-0.50	-0.50	-0.37
X error std dev (ft)	1.02	0.99	0.97	1.02	0.99	1.06	1.08	1.13	1.13	1.04	1.13	1.01	0.86	0.86	0.76

Table 1 – Navigation Sensor Error Statistics

Distance from TD (nmi)	0.97	0.90	0.83	0.77	0.70	0.63	0.57	0.50	0.43	0.37	0.30	0.23	0.17	0.10	0.03
Y error mean (ft)	0.87	1.08	1.12	0.93	0.62	0.16	-0.26	-0.63	-0.90	-0.47	-0.25	-0.47	-0.92	-1.10	-0.92
Y error std dev (ft)	1.54	1.61	1.89	2.20	2.56	2.87	3.06	2.85	2.56	2.40	2.25	2.13	1.86	1.90	1.96
Z error mean (ft)	-0.33	-0.14	0.05	0.04	0.08	0.11	-0.11	-0.14	-0.05	0.09	-0.04	-0.28	-0.03	0.17	0.27
Z error std dev (ft)	0.72	0.66	0.45	0.31	0.36	0.62	0.43	0.64	0.96	1.03	0.84	0.72	0.81	0.71	0.89

Table 2 – Flight Technical Error Statistics

Distance from TD (nmi)	0.97	0.90	0.83	0.77	0.70	0.63	0.57	0.50	0.43	0.37	0.30	0.23	0.17	0.10	0.03
Y error mean (ft)	1.13	1.35	1.39	1.19	0.91	0.43	0.02	-0.36	-0.63	-0.22	0.00	-0.21	-0.66	-0.84	-0.69
Y error std dev (ft)	1.57	1.64	1.91	2.21	2.58	2.88	3.08	2.86	2.57	2.42	2.27	2.15	1.88	1.92	1.98
Z error mean (ft)	-0.56	-0.35	-0.16	-0.14	-0.11	-0.08	-0.29	-0.32	-0.24	-0.11	-0.25	-0.49	-0.18	0.01	0.16
Z error std dev (ft)	0.78	0.73	0.54	0.44	0.47	0.70	0.54	0.73	1.02	1.08	0.91	0.78	0.85	0.75	0.92

Table 3 – Total System Error Statistics

Touchdown Dispersion Data

Because the approaches were flown hook up, several methods were used to estimate the hook touchdown point. A primary method in use for many years during ACLS verifications is a visual spotter for longitudinal touchdown. The spotter notes the main wheel touchdown point and then subtracts 25 ft (in the case of the F-18 and nominal pitch attitude) for the hook offset. These estimates were further refined by taking the actual main gear to hook offset for each approach as calculated from the pitch attitude data from the INS. This data is shown in Table 4.

A second method was used to estimate touchdown point using the SRGPS and INS data is described in reference 3. The results of this analysis in the longitudinal direction are shown in the right-hand column of Table 4. In addition, both longitudinal and lateral estimated hook touchdown points are plotted in figure 14 in relation to the arresting gear wires and the commanded touchdown point. Figure 14 shows the landing area to scale, where the arresting wires are 40 feet apart and symmetrically placed about the desired touchdown point.

Most of the projected touchdown points are in good agreement with the visual data, except for pass 2 of 23 April and Pass 8 of 24 April, where the INS-GPS method estimated touchdown points over 20 ft longer than the visual data.

Observed Main Wheel Touchdown					
Date/ Pass	Feet from		Main Wheel from TD (ft+ long)	Hook from TD (ft+ long)	INS estimate
	Wire	Wire			
23-Apr					
Pass 2	3	-5	15	-7.21	20.94
Pass 3	3	25	45	17.82	9.56
Pass 5	4	0	60	39.15	36.53
Pass 6	3	-15	5	-21.63	-23.26
24-Apr					
Pass 2	3	10	30	2.87	6.53
Pass 3	3	15	35	6.27	16.47
Pass 4	3	-10	10	-18.76	-12.26
Pass 5	3	15	35	8.37	15.65
Pass 7	4	-5	55	34.56	29.86
Pass 8	3	20	40	19.5	42.86
Mean			33.00	8.09	14.29
Standard Deviation			18.44	20.44	20.55
without pass 6/8					
Mean			35.63	10.38	15.41
Standard Deviation			17.61	19.65	14.95

Table 4 – Observed Touchdown Performance

In order to compare touchdown performance to ACLS, a common control program baseline must be obtained. Since Pass 6 of 23 April and Pass 8 of 24 April used different control program settings, they were removed from the touchdown performance estimates in the subsequent analysis described in reference 3. For these eight approaches, the estimated arresting hook touchdown points averaged 15.4 ft. long and 1.4 ft. starboard of

centerline laterally with dispersions of 15 ft. and 1.1 ft. respectively.

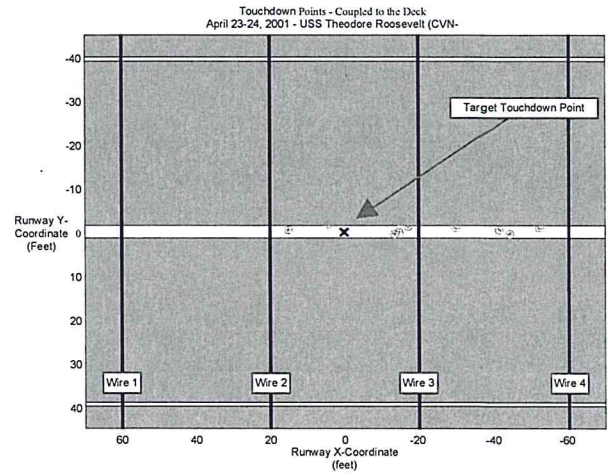

Figure 14 – Estimated Touchdown Performance from SRGPS data.

The SRGPS touchdown statistics exceed the requirements for Navy Precision Approach and Landing System (PALS) certification as shown in Table 5.

	Certification Target	Not To Exceed	SRGPS Results
Lateral Mean	2	4	1.4
Lateral Std Dev	3	5	1.1
Longitudinal Mean	16	24	15.4
Longitudinal Std Dev	40	60	15.0

Table 5 – Estimated Touchdown Performance of SRGPS versus PALS Certification Requirements.

For aircraft carrier automatic landings the touchdown dispersions are more important than the average touchdown location, because the average touchdown location can be corrected by adjusting the geometry constants in the SRGPS. Overall, results indicate very good performance that is equal to or better than typically seen with the current ACLS. However, the sample size is very limited, the deck motion was quite small and winds over the deck were nominal at 25 knots during the SRGPS demonstration.

CONCLUSION

Ten successful automatic landings were completed aboard the U.S. aircraft carrier Theodore Roosevelt, demonstrating very good touchdown and glideslope performance.

The SRGPS flight-testing demonstrated the feasibility of operating a GPS-based automatic landing system aboard ship.

ACKNOWLEDGEMENTS

This work was performed by the Satellite Navigation and Air Traffic Control Team at Patuxent River, MD, and was sponsored by the Naval Air Systems Command, Air Traffic Control and Landing Systems PMA-213.

The SATNAV team would like to acknowledge the outstanding support from AIRLANT and the personnel from the USS Theodore Roosevelt, without whom this demonstration would not have been possible.

REFERENCES

- [1] The Least-Squares Ambiguity Decorrelation Adjustment: A method For Fast GPS Integer Ambiguity Estimation, PJG Teunissen ,1995
- [2] Use of Inertial Reference Data to Support Differential GPS for Carrier Landings - Breslau, R. and Bruner, P., - Proceedings of the 57th Annual meeting of the Institute of Navigation, Albuquerque, New Mexico, June 11-13, 2001
- [3] Guidance and Control for Shipboard Automatic Landing Using GPS – E.C. Schug, J.W. Aksteter, R.W. Huff, M. Smith - Proceedings of the 57th Annual meeting of the Institute of Navigation, Albuquerque, New Mexico, June 11-13, 2001.