



US006816878B1

(12) **United States Patent**
Zimmers et al.

(10) **Patent No.:** **US 6,816,878 B1**
(45) **Date of Patent:** **Nov. 9, 2004**

(54) **ALERT NOTIFICATION SYSTEM**

(76) Inventors: **Steven L. Zimmers**, 710 Clinton Springs Ave., Cincinnati, OH (US) 45229; **Daniel W. Davis**, 45229 1602 Berry Farm Rd., Lithia, FL (US) 33547

6,346,890 B1 * 2/2002 Bellin 340/825.52
6,463,462 B1 10/2002 Smith et al. 709/206
6,487,495 B1 * 11/2002 Gale et al. 701/209
6,490,525 B2 12/2002 Baron, Sr. et al. 702/3
6,493,633 B2 12/2002 Baron, Sr. et al. 702/3
6,523,038 B1 * 2/2003 Iida et al. 707/100
6,594,345 B1 7/2003 Vinson 379/48

(*) Notice: Subject to any disclaimer, the term of this patent is extended or adjusted under 35 U.S.C. 154(b) by 0 days.

OTHER PUBLICATIONS

(21) Appl. No.: **09/503,141**

Auerbach, *Automatic Telephone Notification of Locations in a Tornado Path*, U.S. Patent Publication 2001/O052847 Published Dec. 20, 2001.

(22) Filed: **Feb. 11, 2000**

Auerbach, Mitchell J., *Emergency Management Communications System*, Provisional Application 60/111,281 filed Dec. 7, 1998.

(51) Int. Cl.⁷ **G08B 21/00**

Auerbach, Mitchell J., *Emergency Management Communications System*, Provisional Application 60/120,096 filed Feb. 16, 1999.

(52) U.S. Cl. **709/200; 709/206; 709/217; 709/218; 340/540**

(58) Field of Search **709/200, 217, 709/218**

* cited by examiner

(56) **References Cited**

Primary Examiner—Rupal Dharia

Assistant Examiner—April L Baugh

(74) *Attorney, Agent, or Firm*—Wood, Herron & Evans, LLP

U.S. PATENT DOCUMENTS

3,595,999 A	7/1971	Cole	179/6 D
4,219,698 A	8/1980	Birilli et al.	179/5 P
4,371,751 A	2/1983	Hilligoss, Jr. et al.	179/5 R
4,811,382 A	3/1989	Sleevi	379/67
5,034,916 A *	7/1991	Ordish	709/204
5,121,430 A *	6/1992	Ganzer et al.	380/258
5,260,986 A *	11/1993	Pershan	455/413
5,515,421 A	5/1996	Sikand et al.	379/67
5,528,674 A	6/1996	Reiss, III	379/102
5,539,809 A *	7/1996	Mayer et al.	379/210.02
5,541,980 A	7/1996	Urewicz	379/61
5,559,867 A	9/1996	Langsenkamp et al.	379/69
5,663,734 A	9/1997	Krasner	342/357
5,825,283 A *	10/1998	Camhi	340/438
5,880,770 A	3/1999	Ilcisin et al.	348/14
5,910,763 A *	6/1999	Flanagan	340/286.02
5,912,947 A *	6/1999	Langsenkamp et al.	379/69
5,923,733 A	7/1999	Binns et al.	379/88.23
5,949,851 A	9/1999	Mahaffey	379/48
6,018,699 A *	1/2000	Baron et al.	702/3
6,021,177 A	2/2000	Allport	379/48
6,169,476 B1 *	1/2001	Flanagan	340/286.02
6,275,774 B1	8/2001	Baron, Sr. et al.	702/3
6,295,346 B1 *	9/2001	Markowitz et al.	379/127.01
6,304,816 B1 *	10/2001	Berstis	701/117

(57) **ABSTRACT**

Asystem for providing alert notifications to multiple persons or to a plurality of related geographic locations. The system stores a database of information including a plurality of communications identifiers and additional information for subscribers having those identifiers, including geographic locations and/or school/organization membership information. The system responds to commands identifying alerts to be delivered to affected geographic areas or schools/organizations, by retrieving communications identifiers in the threatened geographic location or associated with the named school/organization, establishing a communications connection using each retrieved communication identifier, and delivering the alert. Alerts may be initiated by authorized personnel via telephone or Internet interaction with the system, or may be generated automatically from data feeds such as the EMWIN system of the National Weather Service. Alerts may be delivered via telephone, pager (voice or text), e-mail, Internet, or other media.

227 Claims, 24 Drawing Sheets

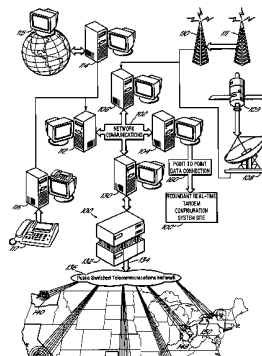

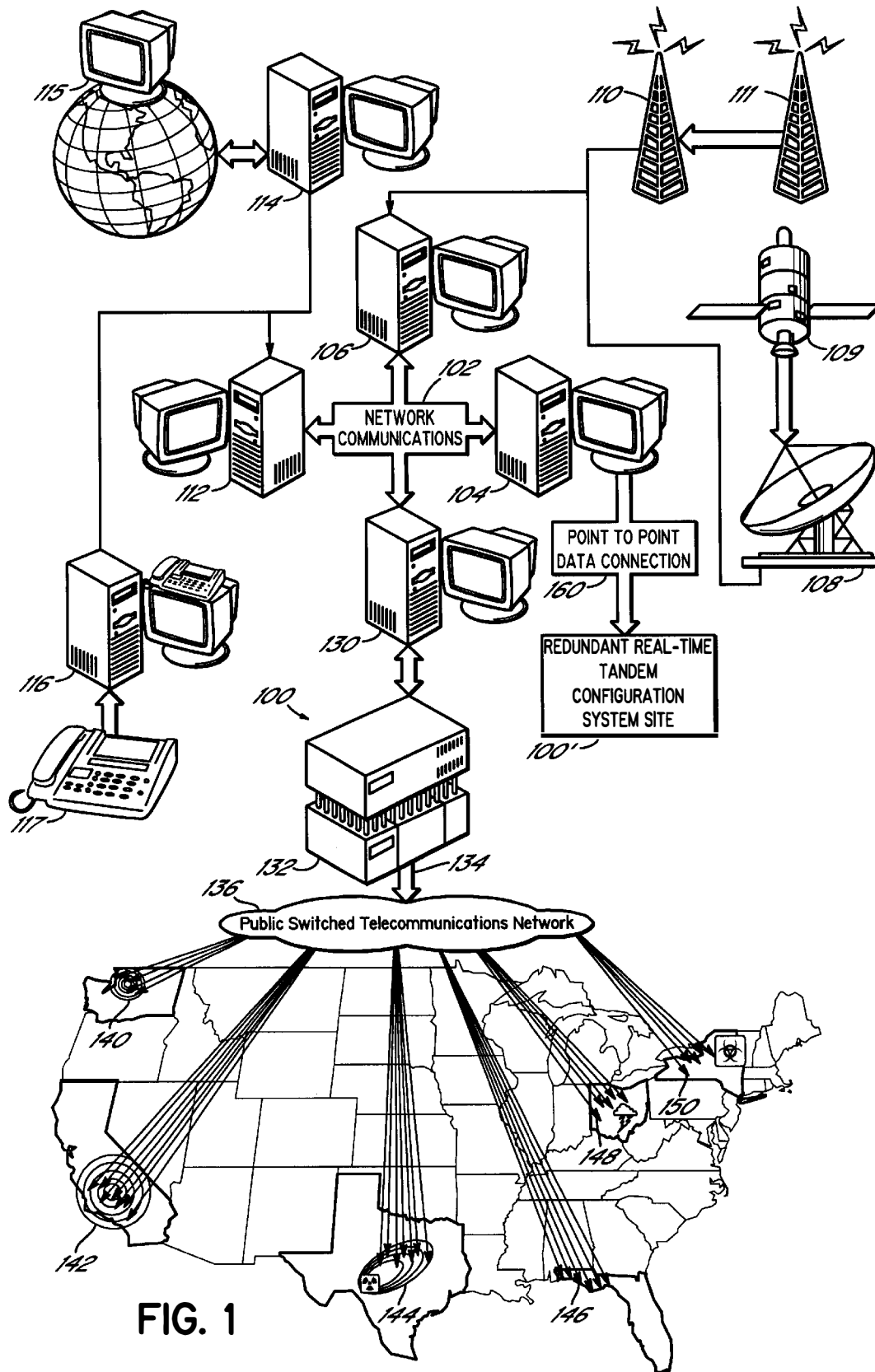

FIG. 1

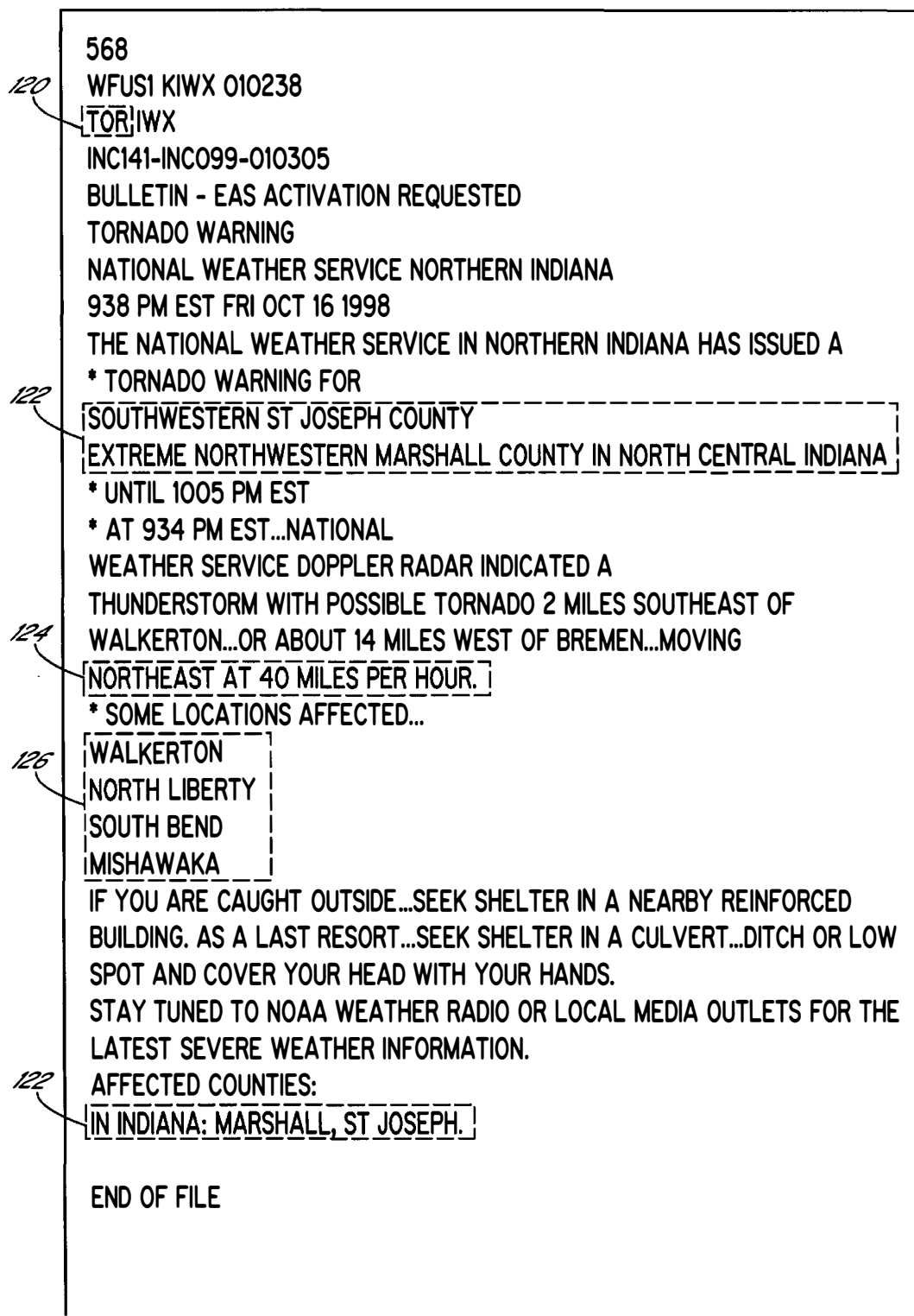

FIG. 2

118

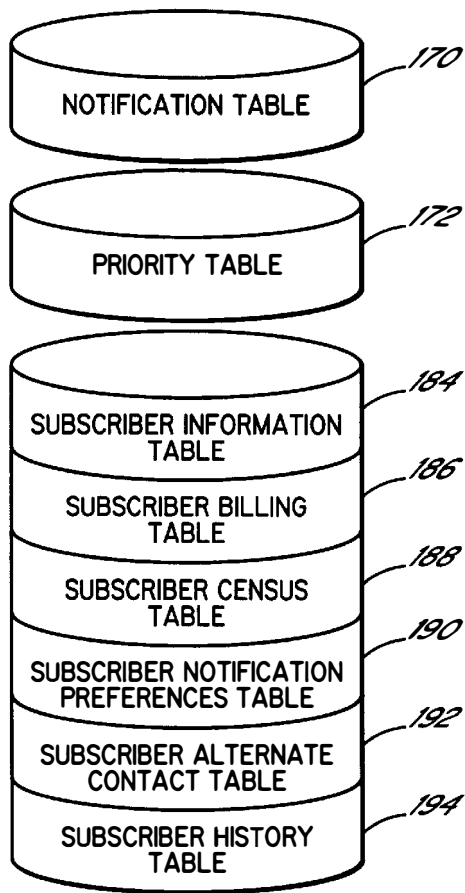

FIG. 3

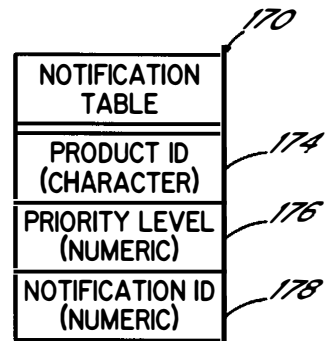

FIG. 3A

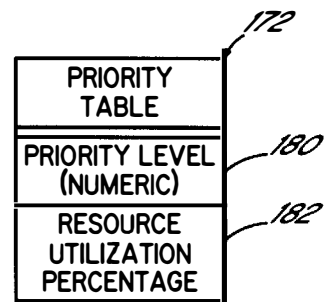
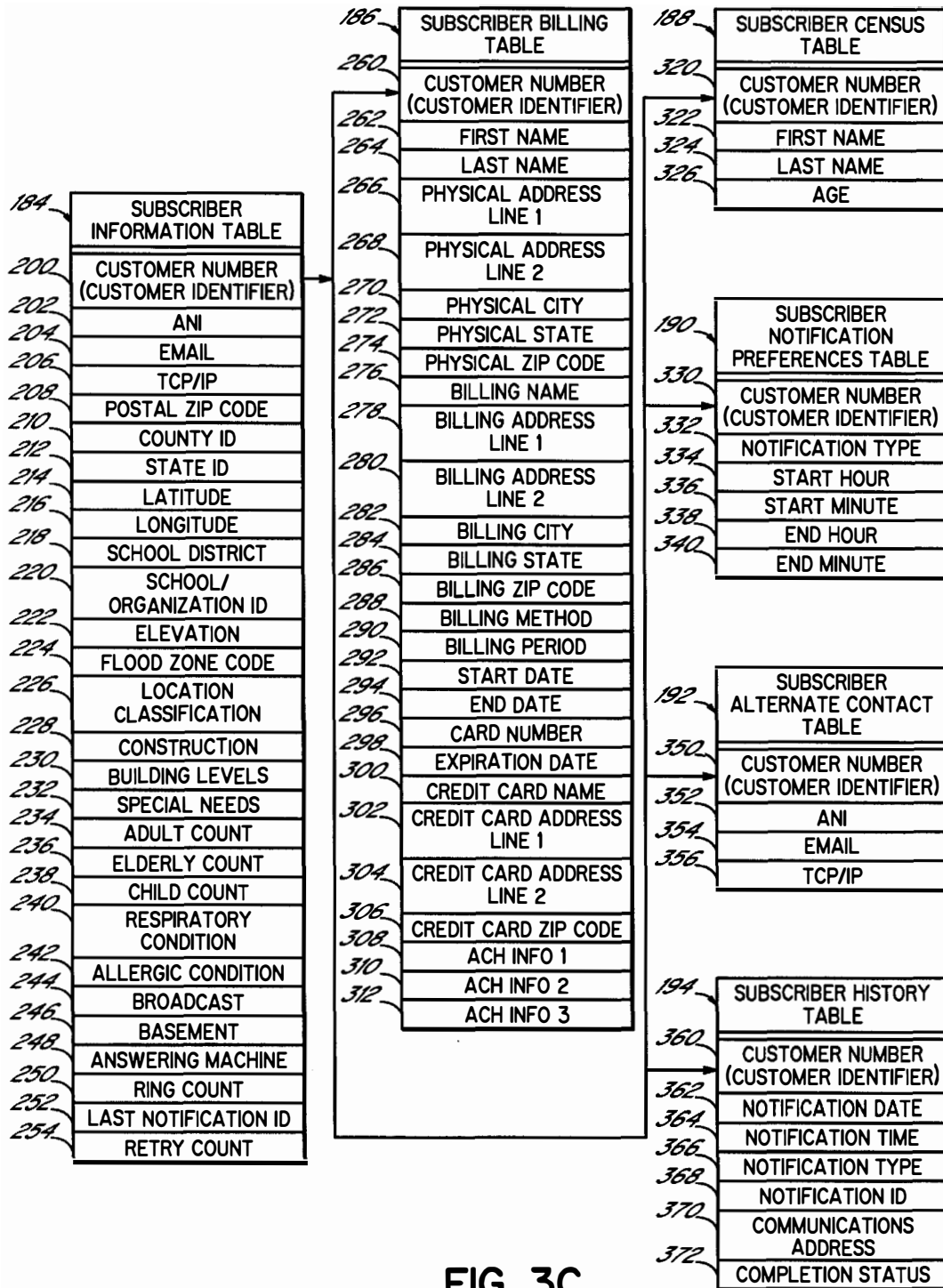

FIG. 3B



Explore Litigation Insights

Docket Alarm provides insights to develop a more informed litigation strategy and the peace of mind of knowing you're on top of things.

Real-Time Litigation Alerts



Keep your litigation team up-to-date with **real-time alerts** and advanced team management tools built for the enterprise, all while greatly reducing PACER spend.

Our comprehensive service means we can handle Federal, State, and Administrative courts across the country.

Advanced Docket Research



With over 230 million records, Docket Alarm's cloud-native docket research platform finds what other services can't. Coverage includes Federal, State, plus PTAB, TTAB, ITC and NLRB decisions, all in one place.

Identify arguments that have been successful in the past with full text, pinpoint searching. Link to case law cited within any court document via Fastcase.

Analytics At Your Fingertips



Learn what happened the last time a particular judge, opposing counsel or company faced cases similar to yours.

Advanced out-of-the-box PTAB and TTAB analytics are always at your fingertips.

API

Docket Alarm offers a powerful API (application programming interface) to developers that want to integrate case filings into their apps.

LAW FIRMS

Build custom dashboards for your attorneys and clients with live data direct from the court.

Automate many repetitive legal tasks like conflict checks, document management, and marketing.

FINANCIAL INSTITUTIONS

Litigation and bankruptcy checks for companies and debtors.

E-DISCOVERY AND LEGAL VENDORS

Sync your system to PACER to automate legal marketing.