

1W 7655477



THE UNITED STATES OF AMERICA

TO ALL TO WHOM THESE PRESENTS SHALL COME:

**UNITED STATES DEPARTMENT OF COMMERCE
United States Patent and Trademark Office**

November 29, 2017

**THIS IS TO CERTIFY THAT ANNEXED IS A TRUE COPY FROM THE
RECORDS OF THIS OFFICE OF THE FILE WRAPPER AND CONTENTS
OF:**

APPLICATION NUMBER: 09/478,315

FILING DATE: January 06, 2000

PATENT NUMBER: 6,522,451

ISSUE DATE: February 18, 2003

**By Authority of the
Under Secretary of Commerce for Intellectual Property
and Director of the United States Patent and Trademark Office**



**SYLVIA HOLLEY
Certifying Officer**

PART (1) OF (3) PARTS

359 265
 09/478315
 07/06/00

359	265
Class	Subclass
ISSUE CLASSIFICATION	

PATENT NUMBER
6522451
 6522451

U.S. UTILITY Patent Application

MS O.I.P.E. PATENT DATE
 SCANNED FEB 13 2003
 G.A. *CU*

CLASS <i>359</i>	SUBCLASS <i>265</i>	ART UNIT <i>2872</i>	EXAMINER <i>S11</i>
---------------------	------------------------	-------------------------	------------------------

TITLE OF INVENTION:

APPLICANT(S):

Certificate
 12-11-2000
 of Correction

ISSUING CLASSIFICATION								
ORIGINAL		CROSS REFERENCE(S)						
CLASS	SUBCLASS	CLASS	SUBCLASS (ONE SUBCLASS PER BLOCK)					
<i>359</i>	<i>265</i>	<i>359</i>	<i>267</i>	<i>841</i>	<i>850</i>	<i>864</i>	<i>866</i>	<i>868</i>
INTERNATIONAL CLASSIFICATION		<i>359</i>	<i>872</i>	<i>877</i>				
<i>G02F</i>	<i>1/15</i>	<i>248</i>	<i>549</i>	<i>900</i>				
<i>G02B</i>	<i>5/08</i>							
<i>G02B</i>	<i>5/10</i>							
<i>G02B</i>	<i>7/182</i>							
<i>B60R</i>	<i>1/06</i>							

<input type="checkbox"/> TERMINAL DISCLAIMER	DRAWINGS			CLAIMS ALLOWED	
	Sheets Drwg. <i>78</i>	Figs. Drwg. <i>16</i>	Print Fig. <i>5B</i>	Total Claims <i>40</i>	Print Claim for O.G. <input checked="" type="checkbox"/>
<input type="checkbox"/> The term of this patent subsequent to _____ (date) has been disclaimed.	_____ (Assistant Examiner) (Date)			NOTICE OF ALLOWANCE MAILED	
<input type="checkbox"/> The term of this patent shall not extend beyond the expiration date of U.S. Patent No. _____	FIELD EXAMINER <i>Randy W. Cliff</i> <i>9/24/02</i> (Primary Examiner) (Date)			<i>9/26/02</i> ISSUE FEE <i>100M</i> Amount Due <i>12800</i> Date Paid <i>12/11/02</i>	
<input type="checkbox"/> The terminal _____ months of this patent have been disclaimed.	<i>AS Smith</i> <i>10-18-02</i> (Legal Instruments Examiner) (Date)			ISSUE BATCH NUMBER	

WARNING: The information disclosed herein may be restricted. Unauthorized disclosure may be prohibited by the United States Code Title 35, Sections 122, 181 and 368. Possession outside the U.S. Patent & Trademark Office is restricted to authorized employees and contractors only.

Form PTO-436A (Rev. 6/99) FILED WITH: DISK (CRF) FICHE CD-ROM (Attached in pocket on right inside flap)

Formal Drawings (*3* sheets) set

(FACE)

SERIAL NUMBER 09/478,315	FILING DATE 01/06/00	CLASS 359	GROUP ART UNIT 2872	ATTORNEY DOCKET NO. DON01-P-793
-----------------------------	-------------------------	--------------	------------------------	------------------------------------

APPLICANT

NIAL R. LYNAM, HOLLAND, MI.

NRS

CONTINUING DOMESTIC DATA***
VERIFIED

NRS

371 (NAT'L STAGE) DATA***
VERIFIED

NRS

FOREIGN APPLICATIONS***
VERIFIED

NRS

IF REQUIRED, FOREIGN FILING LICENSE GRANTED 02/16/00

Foreign Priority claimed 35 USC 119 (a-d) conditions met	<input type="checkbox"/> yes <input checked="" type="checkbox"/> no <input type="checkbox"/> yes <input checked="" type="checkbox"/> no	<input type="checkbox"/> Met after Allowance	STATE OR COUNTRY MI	SHEETS DRAWING 7	TOTAL CLAIMS 83	INDEPENDENT CLAIMS 2
Verified and Acknowledged	<u>NRS</u> Examiner's Initials Initials					

ADDRESS
VAN DYKE GARDNER LINN & BURKHART LLP
2851 CHARLEVOIX DRIVE SE
SUITE 207
GRAND RAPIDS MI 49546

TITLE
EXTERIOR MIRROR PLANO-AUXILIARY REFLECTIVE ELEMENT ASSEMBLY

FILING FEE RECEIVED \$1,824	FEES: Authority has been given in Paper No. _____ to charge/credit DEPOSIT ACCOUNT NO. _____ for the following:	<input type="checkbox"/> All Fees <input type="checkbox"/> 1.16 Fees (Filing) <input type="checkbox"/> 1.17 Fees (Processing Ext. of time) <input type="checkbox"/> 1.18 Fees (Issue) <input type="checkbox"/> Other _____ <input type="checkbox"/> Credit
------------------------------------	---	---

PATENT APPLICATION SERIAL NO. _____

U.S. DEPARTMENT OF COMMERCE
PATENT AND TRADEMARK OFFICE
FEE RECORD SHEET

01/24/2000 DBUTLER 00000016 09478315

01 FC:101	690.00 OP
02 FC:103	1134.00 OP

PTO-1556
(5/87)

*U.S. GPO: 1999-459-082/19144

01-07-00

#

01/06/00
3c710 U.S. PTO

PATENT
DON01 P-793
Express Mail No. EL399135945US

IN THE UNITED STATES PATENT AND TRADEMARK OFFICE

Applicant : Niall R. Lynam
For : EXTERIOR MIRROR PLANO-AUXILIARY
REFLECTIVE ELEMENT ASSEMBLY

3c678 U.S. PTO
09/478315
01/06/00

BOX PATENT APPLICATION
Assistant Commissioner for Patents
Washington, D.C. 20231

Dear Sir:

Enclosed herewith is the above identified patent application comprising the following parts:

- 1) Postcard
- 2) Assignment, Form PTO-1619 Recordation Form Cover Sheet, and Assignment Recording Fee of \$40.00
- 3) 23 Pages of Specification
- 4) 12 Pages of Claims (83 claims)
- 5) 1 Page of Abstract
- 6) 7 Sheets of Drawings (in duplicate)
- 7) Declaration and Power of Attorney

Filing Fee:

Basic Fee	\$690.00	\$690.00
Additional Fees		
Each independent claim in excess of three, times \$78.00		\$
Number of claims in excess of twenty, times \$18.00		\$1,134.00
Filing multiple dependent claims per application \$260.00		\$
Total Filing Fee		\$1,824.00

Checks in the amount of \$1,824.00 and \$40.00 are enclosed to cover the fees noted above.

The Commissioner is hereby authorized to charge payment of the following fees associated with this communication, and during the pendency of this application, or to credit any overpayment, to Deposit Account No. 22-0190. A duplicate copy of this sheet is enclosed.

- 1) Any additional filing fees required under 37 CFR 1.16 for which full payment has not been tendered.
- 2) Any patent application processing fees under 37 CFR 1.17 for which full payment has not been tendered.

Respectfully submitted,

NIALL R. LYNAM

By: Van Dyke, Gardner, Linn & Burkhart, LLP

January 6, 2000
Date

Catherine S. Collins
Catherine S. Collins
Registration No. 37 599
P.O. Box 888695
2851 Charlevoix Drive, S.E.
Grand Rapids, MI 49588-8695
(616) 975-5500

CSC:lmsc

PATENT
DON01 P-793
Express Mail No. EL399135945US

IN THE UNITED STATES PATENT AND TRADEMARK OFFICE

Applicant : Niall R. Lynam
For : EXTERIOR MIRROR PLANO-AUXILIARY
REFLECTIVE ELEMENT ASSEMBLY

Box Patent Application
Assistant Commissioner for Patents
Washington, D.C. 20231

Dear Sir:

CERTIFICATE OF EXPRESS MAIL

I certify that the attached return postcard, Transmittal Letter (in duplicate), Form PTO-1619 Recordation Form Cover Sheet, Assignment, a check in the amount of \$40.00 for the recordal fee, 23 pages of Specification, 12 pages of claims (83 claims), 1 page of Abstract, 7 sheets of drawings (in duplicate), Declaration and Power of Attorney, and a check in the amount of \$1,824.00 for the filing fee are being deposited with the United States Postal Service as Express Mail in an envelope having Express Mail Label Number EL

US addressed to:

Box Patent Application
Assistant Commissioner for Patents
Washington, D.C. 20231

on January 6, 2000.

Lynette M. S. Clark
Lynette M. S. Clark
Van Dyke, Gardner, Linn & Burkhardt, LLP
P.O. Box 888695
Grand Rapids, MI 49588-8695
(616) 975-5500

CSC:lmsc
Enclosures

EXTERIOR MIRROR PLANO-AUXILIARY REFLECTIVE ELEMENT ASSEMBLY

TECHNICAL FIELD AND BACKGROUND OF THE INVENTION

The present invention relates to exterior sideview mirror assemblies suitable for use on an automobile, and more specifically, to plano-auxiliary reflective element assemblies
5 for use in automobile exterior sideview mirror assemblies.

Automobiles are typically equipped with an interior rearview mirror assembly (adapted for providing a rearward field of view immediately rearward of the vehicle, typically principally in the road lane the vehicle is traveling in) and at least one exterior sideview mirror assembly attached to the side of the vehicle (typically adjacent a front side
10 window portion). The exterior side view mirror assembly typically comprises a reflective element adapted to provide a rearward field of view of the side lane adjacent the vehicle so as to allow the driver see whether a side approaching vehicle is present when the driver is contemplating a lane change. Conventionally, automobiles are equipped with a driver-side exterior mirror assembly and, very often, with a passenger-side exterior sideview mirror
15 assembly mounted to the side of the automobile body opposite to that of the driver-side assembly. While the combination of an interior rearview mirror with a driver-side exterior mirror (and especially in a three-mirror system comprising an interior rearview mirror with a driver-side exterior mirror and a passenger-side exterior mirror) works well in many driving situations, rear vision blind spots present a potential safety hazard while driving. A rear
20 vision blind spot is an area adjacent the side of an automobile where a view of another vehicle (overtaking on that side) is not captured in the rearward field of view of the exterior mirror reflector on that side. This presents a potential safety hazard as the driver, upon checking the view in the exterior sideview mirror and seeing no overtaking vehicle therein, may deem it safe to initiate a lane change, unaware that there is a vehicle immediately
25 adjacent in a blind-spot of the exterior mirror reflector.

Various attempts have been made conventionally to minimize and/or eliminate exterior mirror blind-spots on vehicles. One approach is to make the exterior mirror reflector larger, and particularly wider with respect to the vehicle body. By increasing the width of the exterior mirror reflector, it has a wider field of view rearwards, and hence the reflector blind-

spot is reduced. While use of a wide exterior mirror reflector is an option for trucks, buses and commercial vehicles, increasing the width of the reflector used in an exterior sideview mirror assembly mounted on automobiles (such as sedans, station wagons, sports cars, convertibles, minivans, sports utility vehicles, pick-up trucks and similar passenger carrying automobiles) is often not an option. In such domestic automobiles, increasing the width of the exterior mirror reflector increases the size of the exterior sideview mirror assembly with a concomitant increase in aerodynamic drag, increase in fuel consumption, increased difficulty in parking in tight parking spaces, and increased reflector vibration. Use of a non-flat, curved exterior mirror reflector is commonly used to increase rearward field of view without increasing reflector size.

While working well to increase field of view, use of a curved reflector (such as a convex, spherically-curved reflector) has disadvantages. The field of view rearward increases as the degree of curvature of the bent substrate increases (i.e., the field of view rearward increases as the radius of curvature of the bent substrate decreases). However, such wide-angle mirrors have non-unit magnification and distance perception rearward is distorted. For this reason, convex (spherically-bent) exterior mirror reflectors are required in some countries (such as the United States) to carry a safety warning "OBJECTS IN MIRROR ARE CLOSER THAN THEY APPEAR". Distance perception is particularly important for a driver-side exterior mirror. Indeed, Federal Vehicle Safety Standard No: 111 in the United States (the entire disclosure of which is hereby incorporated by reference herein) requires that the driver-side exterior mirror reflector exhibit unit magnification, and places restrictions on the radius of curvature allowed for any bent passenger-side mirror as well as requiring a safety warning be placed thereon. As an improvement over spherically bent/convex mirror reflectors, aspherical or multiradius mirror reflectors (such as are disclosed in U.S. Patents 4,449,786 and 5,724,187, the entire disclosures of which are hereby incorporated by reference herein) have been developed. Such mirrors are widely used in Europe and Asia for both driver-side exterior mirror reflectors and for passenger-side exterior mirror reflectors. The aspherical or multiradius mirror reflectors typically have a less curved (larger radius of curvature) reflective region that is inboard or closest to the driver when mounted on a vehicle and, usually separated by a demarcation line or the like, have a more curved (smaller radius of curvature) region that is outboard or farthest from the driver when mounted on a vehicle. However, such aspherical or multiradius reflectors do not have unit

53

magnification and so cannot be used when unit magnification is mandated (such as by FMVSS 111, referenced above).

To supplement a flat driver-side exterior mirror reflector, an auxiliary and separate bent reflector is sometimes incorporated into the driver-side exterior sideview mirror assembly. However, this is often not suitable for passenger automobiles because of the extra space required in the sideview mirror assembly to accommodate an auxiliary reflector element. Also, in most passenger automobiles, the position of the side view mirror reflector is adjustable by the driver (such as by a hand-adjust, or by a manually adjustable cable such as a Bowden cable or by an electrically operable actuator, as known in the art) in order to provide to that driver his or her desired rearward field of view, which ill-suits use of a separate, auxiliary reflector. Likewise, addition of stick-on blind-spot mirror reflectors (such as are commonly sold in automotive parts stores and the like) onto an automobile exterior sideview mirror reflector has disadvantages, including obscuring field of view of the automobile mirror reflector and adding to mirror element vibration.

There is thus a need to provide an automobile exterior sideview reflective element, and particularly a driver-side automobile exterior sideview reflective element, that overcomes the disadvantages above and that provides the driver of the automobile with a distortion-free field of view with unit magnification that is supplemented with a wide-angle view of a side lane blind spot, and there is a need that this be provided in a unitary reflective element assembly module suitable to mount onto, and be adjusted by, the mirror reflector adjustment mechanism (such as an electrically operated, motorized actuator) provided in the exterior sideview mirror assembly.

BRIEF DESCRIPTION OF THE DRAWINGS

Fig. 1 is a perspective view of an automobile equipped with exterior sideview mirror assemblies according to this present invention;

Fig. 2 is a top plan partial fragmentary view of the driver's side exterior rearview mirror assembly of Fig. 1;

Fig. 3 is an enlarged sectional view of a plano-multiradius reflective element assembly of the mirror assembly in Fig. 2;

Fig. 4 is an enlarged sectional view of a demarcation element of the plano-multiradius reflective element assembly of Fig. 3;



Fig. 5A-5H illustrate views of various locations for a plano reflective element and an auxiliary reflective element according to this present invention;

Fig. 6 is a sectional view of a second embodiment of a plano reflective element assembly according to the present invention including a demarcation element formed as a dividing wall in a backing plate element;

Fig. 6A is a cross-section taken along line XX of Fig.6;

Fig. 6B is a cross-sectional view taken along line YY of Fig.6; and

Fig. 7 is a schematic of a third embodiment of a plano-auxiliary reflective element assembly according to this present invention.

SUMMARY OF THE INVENTION

This invention provides a plano reflective element with unit magnification and an auxiliary reflector element for use in an exterior sideview mirror assembly on an automobile. More specifically, this invention provides a plano-multiradius reflective element assembly suitable for use in an exterior sideview mirror assembly mounted to the side body of an automobile. The plano-multiradius reflective element assembly of this invention is especially suitable for mounting in a driver-side exterior sideview mirror assembly that is mounted to the side of the automobile body adjacent to the seating position of the driver in the front of the interior vehicular cabin. The plano-multiradius reflective element assembly of this invention comprises a plano portion which has a rearward field of view, when mounted in an exterior sideview mirror assembly mounted to the side body of an automobile, with unit magnification. This plano portion comprises a flat substrate, typically a flat glass substrate, provided with a reflective surface. The plano-multiradius reflective element assembly of this invention also includes a multiradius portion with a rearward field of view, when mounted in an exterior sideview mirror assembly mounted to the side body of an automobile, that has non-unit magnification. The plano portion provides a distortion-free rearward field of view and serves as the principal rearward-viewing portion of the plano-multiradius reflective element. The multiradius portion provides a wide angle rearward field of view, and typically supplements the rearward field of view of the plano portion. This multiradius portion comprises a curved substrate, typically a bent glass substrate, provided with a reflective surface. The plano portion and the multiradius portion are demarcated apart by a demarcation element. The demarcation element enables the driver of a vehicle equipped with the plano-multiradius reflective element of this invention to readily delineate a rearward

5

view in the plano portion from a rearward view in the multiradius portion. The plano portion comprises a flat reflective element and the multiradius portion comprises a bent reflective element. The flat, plano reflective element and the curved, multiradius reflective element are individually and separately manufactured, and are adjacently attached to a single backing plate (which typically comprises a polymeric substrate, most typically a molded polymeric substrate), and with the demarcation element disposed at the joint of the plano, flat reflective element and the multiradius, bent reflective element. The backing plate is fabricated (typically by polymeric molding) to have a flat portion that corresponds to the plano, flat reflective element, and a curved surface that corresponds to the multiradius, curved reflective element. The attachment of the plano reflective element and an auxiliary reflective element to a single backing plate produces a unitary plano-auxiliary reflective element assembly suitable for mounting in an exterior sideview mirror assembly. By adjusting the position of the backing plate within the exterior sideview mirror assembly, the rearward fields of view of both the plano reflective element and the auxiliary reflective element are simultaneously and similarly aligned.

One embodiment of the invention includes an exterior sideview mirror system suitable for use in an automobile comprising an exterior sideview mirror assembly adapted for attachment to a side of the automobile. The exterior sideview mirror assembly includes a reflective element having a rearward field of view when attached to said side of the automobile. The reflective element is attached to an actuator and is movable by the actuator in order to position the reflective element's rearward field of view in response to a control. The reflective element comprises a plano-multiradius reflective element assembly which comprises a plano reflective element having unit magnification and a separate multiradius reflective element having a multiradius curvature. The plano element and the separate multiradius element of the plano-multiradius reflective element assembly are attached to a backing plate element. The backing plate element is mounted to the actuator such that movement of the backing plate element (and hence the plano-multiradius reflective element assembly) by the actuator simultaneously and similarly moves the plano element and the multiradius element. The plano element and the multiradius element are separately and, preferably, adjacently attached to the backing plate element at a joint.

In a further embodiment, a demarcation element is disposed at this joint to form a demarcation between the plano element and the multiradius element; this demarcation

6

element having a portion visible to a driver of the automobile. Preferably, the demarcation element is dark colored, such as with a color selected from the group consisting of black, grey, blue and brown. Optionally, there is a space at the joint of the plano element and the multiradius element and the demarcation element is at least partially disposed in said space
5 between said plano element and said multiradius element. The demarcation element can comprise at least one of a polymer material, a tape, a plastic film, a paint, a lacquer and a caulk.

In a further embodiment, the demarcation element comprises a wall on the backing plate element; this wall being located on the backing plate element at the joint of the
10 plano element and the multiradius element, this wall separating the respective elements apart.

In preferred embodiments, the portion of the demarcation element visible to a driver of an automobile equipped with the plano-multiradius reflective element assembly of this invention has a width from about 0.5 mm to about 4 mm.

In preferred embodiments, the plano element is attached to the backing plate
15 element by at least one of an adhesive attachment and a mechanical attachment.

In preferred embodiments, the multiradius element is attached to the backing plate element at a location such that, when the exterior mirror assembly is attached to a side of an automobile, at least portion, and preferably at least a substantial portion, of the plano element is disposed closer to the side of the vehicle than any portion of the multiradius
20 element element.

In preferred embodiments, the multiradius element comprises a bent glass substrate with radii of curvature in the range of from about 4000 mm to about 50 mm, and the ratio of the width of the plano element to the width of the multiradius element is greater than
1.

In preferred embodiments, the principal axis of the rearward field of view of the auxiliary, multiradius element is different from and angled to the principal axis of the rearward field of view of the plano element when both are attached to the backing plate element of the plano-multiradius reflective element assembly and when the plano-multiradius reflective element assembly is mounted in an exterior sideview mirror assembly on an
25 automobile. The principal axis of the rearward field of view of the plano element is directed generally parallel to the longitudinal axis of an automobile equipped with the plano-multiradius reflective element assembly and the principal axis of the rearward field of view
30

of the multiradius element is directed generally at an angle downwards to the longitudinal axis of the vehicle.

In a preferred embodiment, the exterior sideview mirror assembly equipped with the plano-multiradius reflective element assembly comprises a fixedly attached exterior sideview mirror assembly. In another preferred embodiment, the exterior sideview mirror assembly equipped with the plano-multiradius reflective element assembly comprises a break-away exterior sideview mirror assembly. In another preferred embodiment, the exterior sideview mirror assembly equipped with the plano-multiradius reflective element assembly comprises a powerfold exterior sideview mirror assembly. In another preferred embodiment, the actuator of the exterior sideview mirror assembly to which the plano-multiradius reflective element assembly is mounted comprises an electrically operable actuator. In another preferred embodiment, the actuator of the exterior sideview mirror assembly to which the plano-multiradius reflective element assembly is mounted is controlled by a switch or by a memory controller. In another preferred embodiment, the plano element and/or the multiradius element of the plano-multiradius reflective element assembly comprises an electro-optic reflective element, preferably an electrochromic reflective element. In another preferred embodiment, the plano element of the plano-multiradius reflective element assembly comprises an electro-optic reflective element, preferably an electrochromic reflective element, and the multiradius element comprises a fixed reflectance mirror reflector, such as a fixed reflectance mirror reflector comprises a bent glass substrate coated with a metallic reflector coating.

In a preferred embodiment, the plano-auxiliary reflective element assembly is formed in an integral molding operation.

These and other advantages, features, and modifications will become more apparent when reviewed in conjunction with the drawings and the detailed description which follows.

DETAILED DESCRIPTION OF THE PREFERRED EMBODIMENTS

As illustrated in Fig. 1, passenger automobile 10 (which may be a sedan, a station-wagon, a sports car, a convertible, a minivan, a sports utility vehicle, a pick-up truck or a similar passenger carrying non-commercial, personal transportation automobile) includes an interior rearview mirror assembly 18 positioned within interior vehicle cabin 25. Interior vehicle cabin 25 further includes a steering wheel 16, a driver seat 20 positioned at

steering wheel 16, a front passenger seat 21 adjacent to driver seat 20 in the front portion of cabin 25, and a rear passenger seat 23 in the rear portion of cabin 25. Automobile 10 further includes a driver-side exterior sideview mirror assembly 12 and a passenger-side exterior sideview mirror assembly 14, each adapted for attachment to opposing sides of automobile body 11, most preferably adjacent to the seating position of the driver seated in driver seat 20 for driver-side assembly 12 and adjacent to the front passenger seat 21 for passenger-side assembly 14. Exterior sideview mirrors, mounted as shown in Fig. 1 close to the driver seating location, are commonly referred to as door-mounted exterior sideview mirror assemblies. Driver-side exterior sideview mirror assembly 12 includes, as illustrated in Fig. 2, a plano-multiradius exterior sideview reflective element assembly 30. Plano-multiradius reflective element assembly 30 is mounted to a reflective element positioning actuator 36. The orientation of plano-multiradius reflective element assembly 30, and hence its rearward field of view, is adjustable by actuator 36 in response to control 37. Control 37 can comprise a handset control that allows the driver manually move the orientation of plano-multiradius reflective element assembly 30 within exterior mirror housing 40 (such as by a lever control or by a cable control) and hence reposition the rearward field of view of plano-multiradius reflective element assembly 30. Alternately, when actuator 36 comprises an electrically actuated actuator that is electrically operable incorporating at least one motor, control 37 can comprise a switch (which, preferably, is operable under control of the driver seated in cabin 25) or control 37 can comprise a memory controller, as known in the automotive mirror art, that controls actuator 36 to move the position of plano-multiradius reflective element assembly 30 to a pre-set orientation that suits the rearward field of view preference of an individual driver. Actuator 36 is mounted to bracket 38 which attaches to vehicle body side 11. Plano-multiradius reflective element assembly 30 is positionable by actuator 36 within exterior mirror housing 40.

Plano-multiradius reflective element assembly 30, as shown in Fig. 3, comprises a plano element 50 and a separate multiradius element 55. Preferably, plano element 50 is adjacent to multiradius element at a joint. At their joint, plano element 50 and separate multiradius element 55 can touch leaving substantially no gap or space therebetween, or plano element 50 and separate multiradius element 55 can be spaced apart at their joint by a space or gap, as in Fig. 3. Plano element 50 and multiradius element 55 are both mounted to surface 59 of, and are both supported by, a single backing plate element 60.

Plano element 50 and multiradius element 55 are demarcated apart by demarcation element 65. Surface 61 of backing plate element 60 is preferably adapted to attach, such as by attachment member 64, to actuator 36 when plano-multiradius reflective element assembly 30 is mounted in driver-side exterior sideview mirror assembly 12 (and/or in passenger-side exterior side view mirror assembly 14) such that plano element 50 and multiradius element 55 are adjusted and positioned in tandem and simultaneously when the driver (or alternatively, when a mirror memory system, as is conventional in the rearview mirror arts) activates actuator 36 to reposition the rearward field of view of plano-multiradius reflective element assembly 30. Thus, since elements 50, 55 are part of plano-multiradius reflective element assembly 30, movement of plano-multiradius reflective element assembly 30 by actuator 36 simultaneously and similarly moves plano element 50 and multiradius element 55.

Plano element 50 preferably comprises a flat reflector-coated glass substrate having unit magnification, and comprises a reflective surface through which the angular height and width of the image of an object is equal to the angular height and width of the object when viewed at the same distance (except for flaws that do not exceed normal manufacturing tolerances). Plano element 50 may comprise a conventional fixed reflectance mirror reflector or it may comprise a variable reflectance mirror reflector whose reflectivity is electrically adjustable. For example, plano element 50 may comprise a flat glass substrate coated with a metallic reflector coating such as a chromium coating, a titanium coating, a rhodium coating, a metal alloy coating, a nickel-alloy coating, a silver coating, an aluminum coating (or any alloy or combination of these metal reflectors). The metal reflector coating of plano element 50 may be a first surface coating (such as on surface 66) or a second surface coating (such as on surface 67), as such terms are known in the mirror art. The reflector coating on plano element 50 may also comprise a dielectric coating, or a multilayer of dielectric coatings, or a combination of a metal layer and a dielectric layer to form automotive mirror reflectors as known in the automotive mirror art. If a variable reflectance reflector element, plano element 50 preferably comprises an electro-optic reflector element and, most preferably, an electrochromic reflector element.

When mounted into exterior side view mirror assembly 12 and/or 14, plano-multiradius reflective element assembly 30 is preferably orientated so that at least a portion of (more preferably a substantial portion of) the reflector surface of plano element 50 is

positioned closer to the vehicle body (and hence to the driver) than any portion of the reflector surface of multiradius element 55. Thus, and referring to Figure 3, side A of plano element 50 of plano-multiradius reflective element assembly 30 is positioned closer to the driver than side D of multiradius element 55 when plano-multiradius reflective element assembly 30 is mounted on an automobile. Also, when mounted into exterior side view mirror assembly 12 and/or 14, surfaces 66, 68 of plano-multiradius reflective element assembly 30 face rearwardly in terms of the direction of vehicle travel.

Multiradius element 55 of plano-multiradius reflective element assembly 30 preferably comprises a curved/bent mirrored glass substrate. The degree of curvature preferably increases (and hence the local radius of curvature decreases) across the surface of multiradius element 55 with the least curvature (largest radius of curvature) occurring at the side of multiradius element 55 (side C in Fig. 3) positioned adjacent its joint to plano element 50 when both are mounted on backing plate element 60. Thus, and referring to Figure 3, the local radius of curvature at side C of multiradius element 55, when mounted on backing plate element 60, is larger than at side D. Also, the local radius of curvature preferably progressively decreases across multiradius element 55 from side C to side D. Preferably, the local radius of curvature at side C of multiradius element 55 is at least about 1000 mm; more preferably is at least about 2000 mm and most preferably is at least about 3000 mm whereas the local radius of curvature at side D of multiradius element 55 is, preferably, less than about 750 mm, more preferably less than about 350 mm; most preferably less than about 150 mm. Preferably, multiradius element 55 comprises a bent glass substrate with radii of curvature in the range of from about 4000 mm to about 50 mm. The multiradius prescription for the multiradius element to be used in a particular exterior mirror assembly can vary according to the specific field of view needs on a specific automobile model.

The total field of view rearwardly of the automobile of the plano-auxiliary reflective element assembly (which is a combination of the field of view of the plano reflective element and of the auxiliary reflective element) preferably generally subtends an angle of at least about 20 degrees (and more preferably, generally subtends an angle of at least about 25 degrees and most preferably, generally subtends an angle of at least about 30 degrees) with respect to the side of an automobile to which is attached an exterior sideview mirror assembly equipped with the plano-auxiliary reflective element assembly.

Multiradius element 55 may comprise a conventional fixed reflectance mirror reflector or it may comprise a variable reflectance mirror reflector whose reflectivity is electrically adjustable. For example, multiradius element 55 may comprise a flat glass substrate coated with a metallic reflector coating such as a chromium coating, a titanium coating, a rhodium coating, a metal alloy coating, a nickel-alloy coating, a silver coating, an aluminum coating (or any alloy or combination of these metal reflectors). The metal reflector coating of multiradius element 55 may be a first surface coating (such as on surface 68) or a second surface coating (such as on surface 69), as such terms are known in the mirror art. The reflector coating on multiradius element 55 may also comprise a dielectric coating, or a multilayer of dielectric coatings, or a combination of a metal layer and a dielectric layer to form automotive mirror reflectors as known in the automotive mirror art. If a variable reflectance reflector element, multiradius element 55 preferably comprises an electro-optic reflector element and, most preferably, an electrochromic reflector element.

Also, it is preferable that the thickness of plano element 50 and multiradius element 55 be substantially the same in dimension so that their respective outer surfaces, 66 and 68, are substantially coplanar so that a driver can readily view images in either or both elements. The thickness dimension of elements 50,55 is determined by the thickness of the substrate (or in the case of laminate-type electrochromic reflective elements, the thickness of the two substrates between which the electrochromic medium is disposed). For example, plano element 50 and/or multiradius element 55 can comprise a reflector coated glass substrate or panel of thickness preferably equal to or less than about 2.3 mm, more preferably equal to or less than about 1.6 mm, most preferably equal to or less than about 1.1 mm. Use of a thinner substrate is beneficial in terms of improving the overall stability/vibration performance of the image seen in plano-multiradius reflective element assembly 30 when mounted to an automobile.

The reflector area of plano element 50 is preferably larger than that of multiradius element 55. Preferably, the width dimension of plano element 50 is larger than the width dimension of multiradius element 55 (both width dimensions measured at their respective widest dimension and with the width of the respective element being gauged with the respective element oriented as it would be orientated when mounted on the automobile). Thus, and referring to Figure 3, the distance from side A to side B of plano element 50 is larger than the distance from side C to side D of multiradius element 55. Thus, the ratio of

12

the width of plano element 50 to the width of multiradius element 55 is preferably greater than 1; more preferably greater than 1.5; most preferably greater than 2.5 in order to provide a large, unit magnification plano element 50 as the principal rear viewing portion of plano-multiradius reflective element assembly 30 and providing multiradius element 55 as a smaller, auxiliary, separate, wide-angle viewing portion of plano-multiradius reflective element assembly 30. For plano-multiradius reflective element assemblies to be mounted to the exterior sideview assemblies of passenger automobiles used non-commercially and for non-towing purpose, the width of plano element 50 (at its widest dimension) is preferably in the range of from about 50 mm to about 225 mm; more preferably in the range of from about 75 mm to about 175 mm; most preferably in the range of from about 100 mm to about 150 mm.

Backing plate element 60 is preferably a rigid polymeric substrate capable of supporting plano element 50 and multiradius element 55. Backing plate element 60 comprises a flat portion (generally between E and F as shown in Fig. 3) that corresponds to and is aligned with plano element 50. Backing plate element 60 also comprises a curved portion (generally between G and H as shown in Fig. 3) that corresponds to and is aligned with multiradius element 55. Preferably, curved portion G-H of multiradius element 55 is fabricated with a multiradius prescription that is substantially the same as the multiradius prescription of multiradius element 55. Backing plate element 60 is formed as a single element to which elements 50 and 55 are separately attached. Preferably, backing plate element 60 is formed by injection molding of a thermoplastic or a thermosetting polymer resin. Materials suitable to use for backing plate element 60 include unfilled or filled polymeric materials such as glass and/or mineral filled nylon or glass and/or mineral filled polypropylene, ABS, polyurethane and similar polymeric materials. For example, backing plate element 60 can be formed of ABS in an injection molding operation. Plano element 50 can be cut from a stock lite of flat chromium mirror-coated 1.6 mm thick glass. Multiradius element 55 can be cut from a stock lite of multiradiusly-bent chromium mirror-coated 1.6 mm thick glass. Plano element 50 and multiradius element 55 can then be attached (such as by an adhesive attachment such as an adhesive pad or by mechanical attachment such by clips, fasteners or the like) to the already molded backing plate element 60. Alternatively, plano element 50 and multiradius element 55 can each be individually loaded into an injection molding tool. Once loaded, a polymeric resin (or the monomers to form a

13

polymeric resin) can be injected into the mold in order to integrally form backing plate element 60 with elements 50, 55 integrally molded thereto. Integral molding of the backing plate element to plano element 50 and multiradius element 55 (along with any other elements such as the demarcation element 65) in a single integral molding operation, is a preferred
5 fabrication process for plano-multiradius reflective element assembly 30.

Plano-multiradius reflective element assembly 30 further preferably includes demarcation element 65 that functions to delineate and demarcate the plano region of the assembly from the wide-angle, multiradius region and also preferably functions to prevent ingress of debris, dirt, water and similar contaminants (such as road splash, car wash spray,
10 rain, snow, ice, leaves, bugs and similar items that plano-multiradius reflective element assembly 30 would be subject to when mounted and used on an automobile) into any gap between plano element 50 and multiradius element 55 when both are attached to backing plate element 60. Optionally, at least a portion of demarcation element 65 can be disposed in any gap between plano element 50 and multiradius element 55 at their joint on backing plate
15 element 60. Preferably, demarcation element 65 is formed of a polymeric material that is dark colored (such as black or dark blue or dark brown or dark grey or a similar dark color) such as a dark colored polypropylene resin or a dark colored nylon resin or a dark colored polyurethane resin or a dark colored polyvinyl chloride resin or a dark colored silicone material. Most preferably demarcation element 65 is formed of an at least partially
20 elastomeric material (such as silicone, or EPDM, or plasticized PVC or the like) in order to provide a degree of vibration dampening for elements 50, 55. As shown in Fig. 4, demarcation element 65 optionally includes a crown portion 70 that includes wing portions 73, 73' and a stem portion 71. Stem portion 71 preferably has a cross-sectional width CCC of less than about 4 mm, more preferably less than about 3 mm and, most preferably less than
25 about 2 mm. Crown portion 70 preferably is dimensioned to not protrude substantially beyond surfaces 66, 68 of elements 50, 55 when demarcation element 65 is installed between elements 50 and 55. Also, wings 73, 73' are preferably dimensioned to protrude (most preferably slightly) onto surfaces 66, 68 of elements 50, 55 when demarcation element 65 is installed between elements 50 and 55 in order to provide a weather barrier seal and/or to at
30 least partially accommodate any dimensional tolerances of elements 50, 55 that could lead to variation in the inter-element gap between sides C and B. While the demarcation element shown in Fig. 4 is one embodiment, other constructions are possible including a demarcation

element that has minimal or no crown portion. Likewise, a demarcation element can have little or no stem portion, especially when the joint between plano element 50 and multiradius element 55 includes no gap to receive a stem. Also, where a gap at the plano to multiradius joint exists, any stem of the demarcation element can at least partially be disposed in such gap so as to at least partially fill the gap (or it can optionally substantially fill the gap).
5
Optionally, demarcation element 65 is fabricated by injection molding of a polymeric resin. After plano element 50 and multiradius element 55 have been attached to backing plate element 60, a separately formed demarcation element 65 can then be inserted (and secured such as by an adhesive or by a mechanical attachment such as by a fastener) into a space
10 between elements 50 and 55. Note that, optionally, side B of plano element 50 and side C of multiradius element 55 can touch (leaving substantially no gap or space therebetween). In such a situation, demarcation element 65 can comprise a dark colored strip such as of a tape or of a plastic film that covers the joint between elements 50 and 55. Alternatively, demarcation element 65 can comprise a preferably dark-colored paint, lacquer, caulk or
15 similar material that can be applied to, and that can preferably fill into, the joint between elements 50 and 55. The width of the portion of demarcation element 65 that is visible to the driver is preferably less than about 4 mm, more preferably less than about 3 mm and most preferably less than about 2 mm, but is equal to or greater than about 0.5 mm, more preferably is equal to or greater than about 0.75 mm, most preferably is equal to or greater
20 than about 1 mm in order to provide adequate demarcation of the plano region from the multiradius radius region without unduly obscuring the rearward field of view of the respective elements. Optionally, demarcation element 65 can be formed as part of backing plate element 60 such as by forming demarcation element 65 as a wall structure of the backing plate element that partitions backing plate element 60 into two regions: A first
25 region adapted to receive plano reflective element 50 and a separate and adjacent second region adapted to receive multiradius reflective element 55.

Thus, and referring to Fig. 6, a second embodiment of plano-multiradius reflective element assembly 130 may include a backing plate element 160 which comprises a plate molded from a polymer resin (such as a polyolefin such as polypropylene or such as
30 ABS or nylon) with a demarcation element 165 that is molded as a wall structure that partitions backing plate element 165 into a first region (from CC to BB) adapted to receive and accommodate plano reflective element 150 and into a second region (from BB to AA)

adapted to receive and accommodate wide-angle optic multiradius reflective element 155. Note that section AA to BB of backing plate element 160 is angled to section BB to CC. Such angling of the auxiliary reflective element relative to the plano element can be advantageous in allowing the auxiliary reflective element view a portion of the road adjacent the automobile that is in a blind spot of the plano reflective element. In this regard, it is preferable that the multiradius element be angled away from the plane of the plano element, as shown in Fig. 6 by the angling of section AA to BB to section BB to CC.

Preferably, demarcation element 65 is formed in an integral molding operation, along with formation of backing plate element 60, and attachment of elements 50, 55 thereto. For example, plano element 50 and multiradius element 55 can each be individually loaded into an injection molding tool. Once loaded, a polymeric resin (or the monomers to form a polymeric resin) can be injected into the mold in order to integrally form backing plate element 60 with elements 50, 55 integrally molded thereto and, in the same molding operation and in the same tool, also form by molding the demarcation element.

Integral molding of the backing plate element to plano element 50 and multiradius element 55 along with creation in the single molding operation of demarcation element 65 (along with any other elements such as attachment member 64) in a single integral molding operation, is a preferred fabrication process for plano-multiradius reflective element assembly 30. By loading all the sub components of plano-multiradius reflective element assembly 30 into a molding tool, and then injecting polymeric resin to form the backing plate, demarcation member and any attachment member, a substantially complete or fully complete plano-multiradius reflective element assembly can be unloaded from the tool at the completion of the integral molding operation (as known in the molding art), thus enabling economy in manufacturing and accommodation of any dimensional tolerances in the sub components.

Where integral molding is so used, it is preferable to use a reactive molding operation such as reactive injection molding of a urethane as such reactive injection molding operations occur at relatively modest temperatures.

Plano element 50 and/or multiradius element 55 can comprise a heater element, as known in the automotive mirror art, that is operable to deice/demist surfaces 66, 68. Such heater elements are conventional and can comprise a positive temperature coefficient heater pad, a resistive heater element and/or a conductive coating. Plano element 50 and/or multiradius element 55 can also optionally comprise a scatterproofing member, as

known in the automotive mirror art, such as an adhesive tape, to enhance safety in an accident.

Also, plano element 50 and/or multiradius element 55 can comprise a variable reflectance electro-optic element such as an electrochromic mirror reflector. Thus, both element 50 and element 55 can comprise an electrochromic mirror element or either of element 50 and element 55 can comprise an electrochromic mirror element and the other can comprise a fixed reflectance non-variable reflectance mirror element such as a metal reflector coated glass panel such as a chromium coated glass substrate. Also, if both plano element 50 and multiradius element 55 comprise an electro-optic element such as an electrochromic mirror element capable of electrically dimmable reflectivity, both elements 50, 55 can dim together and in tandem under control of a common dimming control signal (typically provided by an electro-optic automatic dimming interior mirror assembly mounted in the cabin of the automobile and equipped with photosensors to detect incident glare and ambient light). Alternately, if both plano element 50 and multiradius element 55 comprise an electro-optic element such as an electrochromic mirror element capable of electrically dimmable reflectivity, element 50 can dim independently of element 55 (such as is disclosed in U.S. Patent No. 5,550,677, the entire disclosure of which is hereby incorporated by reference herein). If either or both of elements 50, 55 comprise an electrochromic element, preferably, the electrochromic reflective element comprises a front substrate and a rear substrate with an electrochromic medium disposed between, such as a solid polymer matrix electrochromic medium such as is disclosed in U.S. patent application Serial No. 09/350,930, filed July 12, 1999, entitled "ELECTROCHROMIC POLYMERIC SOLID FILMS, MANUFACTURING ELECTROCHROMIC DEVICES USING SUCH FILMS, AND PROCESSES FOR MAKING SUCH SOLID FILMS AND DEVICES" to Desaraju V. Varaprasad et al., or such as is disclosed in U.S. Patent Nos. 5,668,663; 5,724,187; 5,910,854; and 5,239,405, the entire disclosures of which are hereby incorporated by reference herein. Most preferably, in such laminate-type electrochromic mirror reflective elements, the front substrate comprises a glass plate of thickness less than about 1.6 mm, most preferably about 1.1 mm thickness or lower, and the rear substrate comprises a glass plate of thickness equal to or greater than about 1.6mm, more preferably greater than about 1.8 mm thickness, most preferably equal to or greater than about 2.0 mm thickness. The rearmost surface of the rear substrate (the fourth surface as known in the mirror art) is reflector coated with a high reflecting metal film such

F17
cont'd

as of aluminum or silver, or an alloy of aluminum or silver. Most preferably, the front-most surface of the rear substrate (the third surface as known in the mirror art) is reflector coated with a high reflecting metal film such as of aluminum or silver, or an alloy of aluminum or silver.

5

Backing plate element 65 of plano-multiradius reflective element assembly 30 is optionally equipped on its rearmost surface with attachment member 64 to facilitate attachment to the reflector positioning actuator of the exterior sideview mirror assembly that plano-multiradius reflective element assembly 30 is mounted to. Attachment of plano-multiradius reflective element assembly 30 to the actuator can be by mechanical attachment such as by a tab, clip or fastener, or may be by adhesive attachment such as by a silicone adhesive, a urethane adhesive or a similar adhesive material such as a tape coated on both surfaces with a pressure sensitive adhesive to form a "double-sticky" tape. The exterior sideview mirror assembly, on whose mirror reflector-positioning actuator the plano-multiradius reflective element assembly is mounted, can be a fixedly attached exterior sideview mirror assembly, a break-away exterior sideview mirror assembly and a powerfold exterior sideview mirror assembly, as known in the automotive mirror art.

DISCLOSURE

15

20

25

30

Figs. 5A-5H shows various arrangements of multiradius reflective element 55 relative to its adjacent plano reflective element 50 (with demarcation element 65 disposed at their joint). In Figs. 5A, 5B, 5C, 5E and 5F, plano element 50 is mounted wholly inboard of multiradius element 55. Thus, in Figs. 5A, 5B, 5C, 5E and 5F, plano element 50 would be disposed closer to the vehicle body (and hence to the driver) than multiradius element 55 when plano-multiradius reflective element assembly 30 was mounted in an exterior sideview mirror attached to a side of an automobile. Therefore, in Figs. 5A, 5B, 5C, 5E and 5F, plano element 50 would be mounted inboard relative to the side of the automobile and multiradius element 55 would be mounted outboard relative to the side of the automobile. In general, the location of the multiradius reflective element in the outboard, upper portion of the plano-multiradius reflective element assembly, as in Figs. 5B and 5E, is preferred as this allows the plano portion provide a desired rearward field of view along the side of the vehicle. The configuration as shown in Fig. 5G (where the multiradius reflective element is along the inboard side of the assembly) is also desirable as this allows the driver view the side of the vehicle (something many drivers desire in order to have a frame of reference for their rearward field of view) while facilitating having a wide field of view for the plano portion.

18

Unlike trucks, busses and commercial vehicles the size of an exterior sideview mirror assembly suitable for use on an automobile (and especially when the automobile is not towing a trailer or the like) is restricted. Automobiles generally are non-commercial vehicles intended for personal transportation. Automobiles typically carry 5 passengers or less, although minivans and large sports utility vehicles (which are classified herein as automobiles) can have seat accommodation for up to 10 passengers (although accommodation for 7 passengers or less is more common). The tandem mounting of a plano element of unit magnification and a separate auxiliary element onto a common, single backing plate element, and the mounting of this backing plate element onto an actuator of an exterior sideview mirror assembly so that a driver can simultaneously and similarly move the auxiliary element and the plano element so as to position their respective rearward fields of view, and to achieve this within the relatively restricted space available in a standard automobile-sized exterior sideview mirror assembly is an important element of this present invention. By utilizing a plano element of unit magnification in the plano-multiradius reflective element assembly, and by sizing the reflector area of the plano element larger than the reflector area of the multiradius element and, preferably, by sizing the reflector area of the plano element at a sufficiently large size that the rearward field of view provided by the plano element alone meets and satisfies the minimum field of view requirement mandated by an automaker specification and/or a government regulation, the need to provide a safety warning indicia such as "OBJECTS IN MIRROR ARE CLOSER THAN THEY APPEAR" in the plano element and/or in the multiradius element can be obviated. Preferably, the plano element comprises a reflector surface area of a size sufficient, when mounted as part of a plano-multiradius reflective element assembly in a driver-side exterior sideview mirror assembly on an automobile, to provide the driver of the automobile a view of a level road surface extending to the horizon from a line, perpendicular to a longitudinal plane tangent to the driver's side of the automobile at the widest point, extending 8 feet out from the tangent plane 35 feet behind the driver's eyes (at a nominal location appropriate for any 95th percentile male driver or at the driver's eye reference points established in Federal Motor Vehicle Standard No. 104), with the driver seated in the driver's seat and with the driver's seat in the rearmost position. Also, preferably, the aspect ratio of the plano-multiradius reflective element assembly (defined as the ratio of its largest vertical dimension to its largest horizontal dimension, measured with the plano-multiradius reflective element assembly

OBJECTS IN MIRROR ARE CLOSER THAN THEY APPEAR

19

oriented as it would be oriented when mounted in an exterior sideview mirror assembly on an automobile, and with "horizontal" being generally parallel with the road surface the automobile travels on and "vertical" being generally perpendicular to the road surface the automobile travels on) is preferably less than 1, more preferably less than 0.8, most preferably less than 0.6. Further, it is preferable that the multiradius element be disposed outboard (relative to the side of the vehicle and with the plano-multiradius reflective element assembly oriented as it would be when mounted in an exterior sideview mirror assembly on an automobile) on the plano-multiradius reflective element assembly so that the multiradius element is positioned to provide an auxiliary, wide-angle view of a "blind-spot" region in an adjacent sidelane while the more inboard-disposed plano element with unit magnification provides the principal sideview image to the driver.

Also, it is preferable that the principal axis of the rearward field of view of the multiradius element be different from and angled to the principal axis of the rearward field of view of the plano element when both are attached to the backing plate element of the plano-multiradius reflective element assembly and when the plano-multiradius reflective element assembly is mounted and operated in an exterior sideview mirror assembly on an automobile. Preferably, the principal axis of the rearward field of view of the plano element is directed generally parallel to the road that the automobile equipped with the plano-multiradius reflective element assembly is travelling on (i.e. generally parallel to the longitudinal axis of the automobile) so as to provide the driver with a long-distance view of approaching vehicles in the side lane that the plano element views). However, preferably the principal axis of the rearward field of view of the multiradius element of, for example, a door-mounted driver-side (or passenger-side) exterior sideview mirror assembly in which the plano-multiradius reflective element assembly is mounted is directed generally downwardly towards the road surface adjacent to the driver seating location and/or several feet (such as about 1 foot to about 24 feet; more preferably, about 1 foot to about 12 feet; most preferably about 1 foot to about 8 feet in distance) to its rear (in order to capture a field of view of a rear approaching vehicle that is approaching to overtake, or is about to overtake, or is overtaking the automobile equipped with the plano-multiradius reflective element assembly). Thus, preferably, the principal axis of the rearward field of view of the multiradius element is angled and directed generally downwardly with respect to the longitudinal axis of the automobile and thus is at an angle to the principal axis of the rearward field of view of the

U.S. PATENT & TRADEMARK OFFICE

plano element. For example, multiradius element 155 when attached to surface 173 of backing plate 160 (see Fig. 6B) would have its principal axis of rearward view as indicated by 180 as in Fig. 6B, and as such would be canted towards the road surface when mounted in an exterior sideview mirror assembly attached to the side of an automobile. By contrast,
5 plano element 150 when attached to surface 174 of backing plate 160 (see Fig. 6A) would have a principal axis as indicated by 185 as in Fig. 6A and, as such, would be generally parallel to the road surface when mounted in an exterior sideview mirror assembly attached to the side of an automobile. Having the multiradius element canted somewhat downwards towards the road surface assists visual detection by the driver of overtaking vehicles in the
10 traditional "blind-spot" in the adjacent side lane. The angle that the multiradius element is angled on the backing plate element of the plano-multiradius reflective element assembly relative to the plane of the plano reflective element will vary from automobile model to model, but generally is preferred to be in the about 1 degree to about 10 degree range; about 2 degree to about 8 degree range more preferred; and about 3 degree to about 6 degree range
15 most preferred. In order to conveniently achieve an angling of the multiradius portion with respect to the plano portion (and preferably a downward angling), the portion of the backing plate element that the multiradius reflective element is attached to can be angled relative to the adjacent portion of the backing plate element that the plano reflective portion is attached to. Thus, and referring to Fig. 6, plano-multiradius reflective element assembly 130 includes
20 a molded polymeric backing plate element 160 comprising a generally flat portion 162 (between BB and CC in Fig. 6) and an adjacent curved portion 161 (between AA and BB). As indicated by 190 and 195, portion AA to BB of backing plate element 160 is generally angled to portion BB to CC of backing plate 160. Preferably, the portion of backing plate element 160 to which the auxiliary reflective element attaches is angled towards the front
25 (compared to the angling of plano reflective element) of an automobile equipped with the plano-auxiliary reflective element assembly of the present invention. Fig. 6 is a view of plano-multiradius reflective element assembly 130 as it would appear from above the vehicle as it would be orientated in use (with portion 162 closer to the driver than portion 161). The wall section, section XX in Fig. 6, taken through section 162 of backing plate element 160 is
30 of substantially constant dimension (as illustrated in Fig. 6A) whereas the wall section, section YY in Fig. 6B, taken through section 161 of backing plate element 160 is of varying dimension and is angled. Plano reflective element 150 and multiradius reflective element

21

155 (for example, plano element 150 can comprise an electrochromic mirror element and
multiradius element 155 can comprise a chrome coated glass reflector) are attached to
portions 162 and 161, respectively. By being supported on the angled face 173 (see Fig. 6B)
of portion 161, the principal viewing axis of multiradius reflector element 155 is angled
5 downwards towards the road surface, as compared to the more horizontal-viewing principal
viewing axis of plano element 150, when plano-multiradius reflective element 130 is
mounted in an exterior sideview mirror assembly on an automobile. Demarcation element
165 is preferably molded in the same molding tool as is used to mold backing plate element
160, and so demarcation element 165 is formed as an integral part of backing plate element
10 160, forming a wall thereof that partitions the surface of backing plate element 160 into a
region for receiving the plano reflective element 150 and a region for receiving the auxiliary
reflective element 155. Also, end-caps 170 and 171 are optionally provided. Plano reflective
element 150 can attach into the cavity formed between demarcation element 165 and end-cap
171; multiradius reflective element 155 can attach into the cavity formed between
15 demarcation element 165 and end-cap 170. Note that the portion of the backing plate element
where the wide-angle optic multiradius element attaches can have a thicker wall thickness
than that of the portion of the backing plate element where the unit magnification optic
element attaches in order to allow for the angling of the multiradius element downwardly
relative to the angle of the plano element, as illustrated in Figs. 6A-B. As illustrated in Figs.
20 6A-B, the angle downwards to the longitudinal axis of the vehicle of the multiradius element
can generally be set by an angling of a surface of the backing plate element in order to ensure
that the principal axis of the rearward field of view of the plano element is directed generally
parallel to the longitudinal axis of an automobile equipped with the plano-multiradius
reflective element assembly and that the principal axis of the rearward field of view of the
25 multiradius element is directed generally at an angle downwards to the longitudinal axis of
the automobile.

Note that the provision of the plano-multiradius reflective element assembly
of this invention as a unitary module has manufacturing advantages, particularly for exterior
sideview mirror assembly manufacturers who can procure a plano-multiradius reflective
30 element assembly module from a mirror reflector supplier and then mount the plano-
multiradius reflective element assembly module onto an actuator.

Referring to Fig. 7, a third embodiment 230 of a plano-multiradius reflective element assembly is illustrated. Plano-multiradius reflective element assembly 230 includes a plano reflective element 250 and a separate multiradius reflective element assembly 255, both individually attached to a backing plate element, and with demarcation element 265 disposed at their joint. Plano-multiradius reflective element assembly 230 is about 8.5 inches wide and about 4.25 inches tall (aspect ratio of 0.5), at their largest dimension. Shown as the shaded triangle 240 in plano reflective element 250 is the image of a triangular target object set about 35 feet rearward and of width about 8 feet and of height of about 4.1 feet as would be seen were plano-multiradius reflective element assembly 230 mounted in a driver-side exterior sideview mirror assembly in an automobile such as a sports utility vehicle. In general, it is desirable that the plano reflective element be dimensioned and configured so as to have its rearward field of view capture an image (that is visible, by reflection in the plano reflective element, to a driver seated in the driver's seat in an automobile to which is attached an exterior sideview mirror assembly equipped with the plano-auxiliary reflective element assembly according to this present invention) of a triangular shaped target located about 35 feet rearward of the driver seating location, extending about 8 feet out from the plane defined by the side of the automobile and reaching a height of between about 4 feet and about 5 feet from the road surface at that location 35 feet rearward of the automobile. The total field of view rearwardly of the vehicle of plano-multiradius reflective element assembly 230 (which is a combination of the field of view of plano reflective element 250 and of the auxiliary multiradius reflective element 255) preferably generally subtends an angle of at least about 30 degrees (and more preferably, generally subtends an angle of at least about 35 degrees and most preferably, generally subtends an angle of at least about 40 degrees) with respect to the side of an automobile to which is attached an exterior sideview mirror assembly equipped with plano-multiradius reflective element assembly 230.

Also, although it is preferable to utilize a multiradius or compound curvature reflective element such as an aspherical element or a compound curvature element for the auxiliary mirror element adjacent the plano reflective element (as this enables least discontinuity in image at the joint between the adjacent elements of the assembly), a spherical reflective element (that has substantially only one radius of curvature and, as such, is a section from a sphere) can optionally be used adjacent the plano reflective element instead of, or in addition to, the multiradius reflective element. Also, a plano auxiliary mirror

23

such as a flat mirrored substrate can be used, less preferably, as a substitute for a multiradius reflective element in those embodiments where the auxiliary reflective element is angled relative to the plane of the principal, plano reflective element so as to view a blind spot region of the principal plano element. Also, the plano-multiradius reflective element assembly can optionally be fixedly attached to an exterior sideview mirror assembly housing that is not movable, or, alternately, the exterior sideview mirror assembly housing to which the plano-multiradius reflective element assembly is fixedly attached can itself be actuated to move, such as by motor action, so that by moving the exterior sideview mirror assembly housing, the field of rearward view of the plano-multiradius reflective element assembly fixedly attached thereto can correspondingly move and be repositioned to suit the field of view need of a particular driver seated in the automobile cabin.

The above description is considered that of the preferred embodiments only. Modification of the invention will occur to those skilled in the art and to those who make or use the invention. Therefore, it is understood that the embodiments shown in the drawings and described above are merely for illustrative purposes and are not intended to limit the scope of the invention, which is defined in the following claims as interpreted according to the principles of patent law, including the doctrine of equivalents.

009010-5182460

24

I claim:

1. An exterior sideview mirror system suitable for use in an automobile, said exterior sideview mirror system comprising:

an exterior sideview mirror assembly adapted for attachment to a side of an automobile;

5 said exterior sideview mirror assembly including a reflective element having a rearward field of view when attached to said side of the automobile;

said reflective element attached to an actuator and movable by said actuator in order to position said rearward field of view in response to a control;

10 wherein said reflective element comprises a plano-multiradius reflective element assembly, said plano-multiradius reflective element assembly comprising a plano reflective element having unit magnification and a separate multiradius reflective element having a multiradius curvature; and

15 said plano reflective element and said multiradius reflective element of said plano-multiradius reflective element assembly attached to a backing plate element, said backing plate element mounting to said actuator such that movement of said backing plate element of said plano-multiradius reflective element assembly by said actuator simultaneously and similarly moves said plano reflective element and said multiradius reflective element.

2. The exterior sideview mirror system of Claim 1, wherein said plano reflective element and said multiradius reflective element are adjacently attached to said backing plate element at a joint, and wherein said plano-multiradius reflective element assembly includes a demarcation element, said demarcation element disposed at said joint to form a demarcation

5 between said plano reflective element and said multiradius reflective element, said demarcation element having a portion visible to a driver of the automobile.

3. The exterior sideview mirror system of Claim 2, wherein said demarcation element is dark colored.

4. The exterior sideview mirror system of Claim 3, wherein said demarcation element is dark colored with a color selected from the group consisting of black, grey, blue and brown.

5. ⁷ The exterior sideview mirror system of Claim 2, wherein said joint comprises a space between said plano reflective element and said multiradius reflective element.

6. ⁸ The exterior sideview mirror system of Claim ~~3~~ ⁷, wherein said demarcation element is at least partially disposed in said space between said plano reflective element and said multiradius reflective element.

7. ⁵ The exterior sideview mirror system of Claim 3, wherein said demarcation element comprises at least one of a polymer material, a tape, a plastic film, a paint, a lacquer and a caulk.

8. ⁶ The exterior sideview mirror system of Claim ~~7~~ ⁵, wherein said demarcation element comprises a polymer material.

9. The exterior sideview mirror system of Claim 2, wherein said demarcation element comprises a wall on said backing plate element, said wall located on said backing plate element at said joint, said wall separating said plano reflective element from said multiradius reflective element.

10. The exterior sideview mirror system of Claim 2, wherein said portion visible to a driver of the automobile has a width less than about 4 mm.

11. The exterior sideview mirror system of Claim 2, wherein said portion visible to a driver of the automobile has a width less than about 3 mm.

12. The exterior sideview mirror system of Claim 2, wherein said portion visible to a driver of the automobile has a width less than about 2 mm.

26

13. The exterior sideview mirror system of Claim 2, wherein said portion visible to a driver of the automobile has a width greater than about 0.5 mm.

14. The exterior sideview mirror system of Claim 2, wherein said portion visible to a driver of the automobile has a width greater than about 0.75 mm.

15. The exterior sideview mirror system of Claim 2, wherein said portion visible to a driver of the automobile has a width greater than about 1 mm.

16. The exterior sideview mirror system of Claim 1, wherein said plano reflective element is attached to said backing plate element by at least one of an adhesive attachment and a mechanical attachment.

17. The exterior sideview mirror system of Claim 1, wherein said multiradius reflective element is attached to said backing plate element by at least one of an adhesive attachment and a mechanical attachment.

18. The exterior sideview mirror system of Claim 1, wherein said multiradius reflective element is attached to said backing plate element at a location such that, when said exterior mirror assembly is attached to a side of an automobile, at least a portion of said plano reflective element is disposed closer to said side of the automobile than any portion of said multiradius reflective element.

19. The exterior sideview mirror system of Claim 1, wherein said multiradius reflective element comprises a bent glass substrate with radii of curvature in the range of from about 4000 mm to about 50 mm.

20. The exterior sideview mirror system of Claim 1, wherein the ratio of the width of said plano reflective element to the width of said multiradius reflective element is greater than 1.

21. The exterior sideview mirror system of Claim 1, wherein the ratio of the width of said plano reflective element to the width of said multiradius reflective element is greater than 1.5.

22. The exterior sideview mirror system of Claim 1, wherein the ratio of the width of said plano reflective element to the width of said multiradius reflective element is greater than 2.5.

23. The exterior sideview mirror system of Claim 1, wherein the principal axis of the rearward field of view of said multiradius reflective element is different from and angled to the principal axis of the rearward field of view of said plano reflective element when both are attached to said backing plate element of said plano-multiradius reflective element assembly and when said plano-multiradius reflective element assembly is mounted in said exterior sideview mirror assembly on an automobile.

24. The exterior sideview mirror system of Claim 23, wherein the principal axis of the rearward field of view of said plano reflective element is directed generally parallel to the longitudinal axis of an automobile equipped with the plano-multiradius reflective element assembly and wherein the principal axis of the rearward field of view of said multiradius reflective element is directed generally at an angle downwards to the longitudinal axis of the automobile.

25. The exterior sideview mirror system of Claim 24, wherein said angle downwards to the longitudinal axis of the automobile is in the range from about 1 degree to about 10 degrees.

26. The exterior sideview mirror system of Claim 24, wherein said angle downwards to the longitudinal axis of the automobile is in the range from about 2 degrees to about 8 degrees.

005010-51E82460

Sub
C21

28

009070 5182460

27. The exterior sideview mirror system of Claim 24, wherein said angle downwards to the longitudinal axis of the automobile is in the range from about 3 degrees to about 6 degrees.

28. The exterior sideview mirror system of Claim 24, wherein said angle downwards to the longitudinal axis of the automobile is generally set by an angling of a surface of said backing plate element.

29. The exterior sideview mirror system of Claim 24, wherein said exterior sideview mirror assembly comprises a door-mounted exterior sideview mirror assembly adapted for attachment to a side of the automobile adjacent a driver seating location of a driver of the automobile and wherein the principal axis of the rearward field of view of said multiradius reflective element is directed generally downwardly towards the road surface adjacent to the driver seating location at a distance in the range of about 1 foot to about 24 feet to the rear of the driver seating location.

30. The exterior sideview mirror system of Claim 24, wherein said exterior sideview mirror assembly comprises a door-mounted exterior sideview mirror assembly adapted for attachment to a side of the automobile adjacent a driver seating location of a driver of the automobile and wherein the principal axis of the rearward field of view of said multiradius reflective element is directed generally downwardly towards the road surface adjacent to the driver seating location at a distance in the range of about 1 foot to about 12 feet to the rear of the driver seating location.

31. The exterior sideview mirror system of Claim 24, wherein said exterior sideview mirror assembly comprises a door-mounted exterior sideview mirror assembly adapted for attachment to a side of the automobile adjacent a driver seating location of a driver of the automobile and wherein the principal axis of the rearward field of view of said multiradius reflective element is directed generally downwardly towards the road surface adjacent to the driver seating location at a distance in the range of about 1 foot to about 8 feet to the rear of the driver seating location.

0091070-51282460

32. ³⁰ The exterior sideview mirror system of Claim 1, wherein said exterior sideview mirror assembly comprises a fixedly attached exterior sideview mirror assembly.

33. ³¹ The exterior sideview mirror system of Claim 1, wherein said exterior sideview mirror assembly comprises a break-away exterior sideview mirror assembly.

34. ³² The exterior sideview mirror system of Claim 1, wherein said exterior sideview mirror assembly comprises a powerfold exterior sideview mirror assembly.

35. The exterior sideview mirror system of Claim 1, wherein said actuator comprises an electrically operable actuator.

36. ³³ The exterior sideview mirror system of Claim 1, wherein said control comprises a memory controller.

37. ³⁴ The exterior sideview mirror system of Claim 1, wherein at least one of said plano reflective element and said multiradius reflective element comprises an electro-optic reflective element.

38. ³⁵ The exterior sideview mirror system of Claim 1, wherein both said plano reflective element and said multiradius reflective element comprise an electro-optic reflective element.

39. ³⁶ The exterior sideview mirror system of Claim 1, wherein said plano reflective element comprises an electro-optical reflective element.

40. ³⁷ The exterior sideview mirror system of Claim ³⁶39, wherein said electro-optical reflective element comprises an electrochromic reflective element.

41. ³⁸ The exterior sideview mirror system of Claim ³⁷40, wherein said multiradius reflective element comprises a fixed reflectance mirror reflector.

39

42. The exterior sideview mirror system of Claim 41, wherein said fixed reflectance mirror reflector comprises a bent glass substrate coated with a metallic reflector coating.

38

40

43. The exterior sideview mirror system of Claim 1, wherein said plano-multiradius reflective element assembly is formed in an integral molding operation.

0090FO-S1E82H60

44. An exterior sideview mirror system suitable for use in an automobile, said exterior sideview mirror system comprising:

- an exterior sideview mirror assembly adapted for attachment to a side of an automobile;
- said exterior sideview mirror assembly including a reflective element having a rearward field of view when attached to said side of the automobile;
- said reflective element attached to an electrically operable actuator and movable by said actuator in order to position said rearward field of view in response to a control;
- wherein said reflective element comprises a plano reflective element having unit magnification and a separate auxiliary reflective element;
- said plano reflective element and said auxiliary reflective element attached to a backing plate element, said backing plate element mounting to said actuator such that movement of said backing plate element by said actuator simultaneously and similarly moves said plano reflective element and said auxiliary reflective element;
- and wherein said plano reflective element and said auxiliary reflective element are adjacently attached to said backing plate element at a joint, and wherein a demarcation element is disposed at said joint to form a demarcation between said plano reflective element and said auxiliary reflective element, said demarcation element having a portion visible to a driver of the automobile.

45. The exterior sideview mirror system of Claim 44, wherein demarcation element is dark colored.

30

00910101512827400

46. The exterior sideview mirror system of Claim 44, wherein said demarcation element is dark colored with a color selected from the group consisting of black, grey, blue and brown.
47. The exterior sideview mirror system of Claim 44, wherein said joint comprises a space between said plano reflective element and said auxiliary reflective element.
48. The exterior sideview mirror system of Claim 47, wherein said demarcation element is at least partially disposed in said space between said plano reflective element and said auxiliary reflective element.
49. The exterior sideview mirror system of Claim 44, wherein said demarcation element comprises at least one of a polymer material, a tape, a plastic film, a paint, a lacquer and a caulk.
50. The exterior sideview mirror system of Claim 44, wherein said demarcation element comprises a polymer material.
51. The exterior sideview mirror system of Claim 44, wherein said demarcation element comprises a wall on said backing plate element, said wall located on said backing plate element at said joint, said wall separating said plano reflective element from said auxiliary reflective element.
52. The exterior sideview mirror system of Claim 44, wherein said portion visible to a driver of the automobile has a width less than about 4 mm.
53. The exterior sideview mirror system of Claim 44, wherein said portion visible to a driver of the automobile has a width less than about 3 mm.
54. The exterior sideview mirror system of Claim 44, wherein said portion visible to a driver of the automobile has a width less than about 2 mm.

55. The exterior sideview mirror system of Claim 44, wherein said portion visible to a driver of the automobile has a width greater than about 0.5 mm.

56. The exterior sideview mirror system of Claim 44, wherein said portion visible to a driver of the automobile has a width greater than about 0.75 mm.

57. The exterior sideview mirror system of Claim 44, wherein said portion visible to a driver of the automobile has a width greater than about 1 mm.

58. The exterior sideview mirror system of Claim 44, wherein said plano reflective element is attached to said backing plate element by at least one of an adhesive attachment and a mechanical attachment.

59. The exterior sideview mirror system of Claim 44, wherein said auxiliary reflective element is attached to said backing plate element by at least one of an adhesive attachment and a mechanical attachment.

60. The exterior sideview mirror system of Claim 44, wherein said auxiliary reflective element is attached to said backing plate element at a location such that, when said exterior mirror assembly is attached to a side of an automobile, at least a portion of said plano reflective element is disposed closer to said side of the automobile than any portion of said auxiliary reflective element.

61. The exterior sideview mirror system of Claim 44, wherein said auxiliary reflective element comprises one of a flat glass substrate and a bent glass substrate

62. The exterior sideview mirror system of Claim 44, wherein the ratio of the width of said plano reflective element to the width of said auxiliary reflective element is greater than 1.

009010151600

5

005010-5123460

63. The exterior sideview mirror system of Claim 44, wherein the ratio of the width of said plano reflective element to the width of said auxiliary reflective element is greater than 1.5.

64. The exterior sideview mirror system of Claim 44, wherein the ratio of the width of said plano reflective element to the width of said auxiliary reflective element is greater than 2.5.

65. The exterior sideview mirror system of Claim 44, wherein the principal axis of the rearward field of view of said auxiliary reflective element is different from and angled to the principal axis of the rearward field of view of said plano reflective element when both are attached to said backing plate element and are mounted in said exterior sideview mirror assembly on an automobile.

66. The exterior sideview mirror system of Claim 65, wherein the principal axis of the rearward field of view of said plano reflective element is directed generally parallel to the longitudinal axis of an automobile equipped with said reflective element and wherein the principal axis of the rearward field of view of said auxiliary reflective element is directed generally at an angle downwards to the longitudinal axis of an automobile equipped with said reflective element.

67. The exterior sideview mirror system of Claim 66, wherein said angle downwards to the longitudinal axis of the automobile is in the range from about 1 degree to about 10 degrees.

68. The exterior sideview mirror system of Claim 66, wherein said angle downwards to the longitudinal axis of the automobile is in the range from about 2 degrees to about 8 degrees.

69. The exterior sideview mirror system of Claim 66, wherein said angle downwards to the longitudinal axis of the automobile is in the range from about 3 degrees to about 6 degrees.

70. The exterior sideview mirror system of Claim 66, wherein said angle downwards to the longitudinal axis of the automobile is generally set by an angling of a surface of said backing plate element.

71. The exterior sideview mirror system of Claim 66, wherein said exterior sideview mirror assembly comprises a door-mounted exterior sideview mirror assembly adapted for attachment to a side of the automobile adjacent a driver seating location of a driver of the automobile and wherein the principal axis of the rearward field of view of said auxiliary reflective element is directed generally downwardly towards the road surface adjacent to the driver seating location at a distance in the range of about 1 foot to about 24 feet to the rear of the driver seating location.

72. The exterior sideview mirror system of Claim 66, wherein said exterior sideview mirror assembly comprises a door-mounted exterior sideview mirror assembly adapted for attachment to a side of the automobile adjacent a driver seating location of a driver of the automobile and wherein the principal axis of the rearward field of view of said auxiliary reflective element is directed generally downwardly towards the road surface adjacent to the driver seating location at a distance in the range of about 1 foot to about 12 feet to the rear of the driver seating location.

73. The exterior sideview mirror system of Claim 66, wherein said exterior sideview mirror assembly comprises a door-mounted exterior sideview mirror assembly adapted for attachment to a side of the automobile adjacent a driver seating location of a driver of the automobile and wherein the principal axis of the rearward field of view of said auxiliary reflective element is directed generally downwardly towards the road surface adjacent to the driver seating location at a distance in the range of about 1 foot to about 8 feet to the rear of the driver seating location.

74. The exterior sideview mirror system of Claim 44, wherein said exterior sideview mirror assembly comprises a fixedly attached exterior sideview mirror assembly.

005010-STEELING

75. The exterior sideview mirror system of Claim 44, wherein said exterior sideview mirror assembly comprises a break-away exterior sideview mirror assembly.

76. The exterior sideview mirror system of Claim 44, wherein said exterior sideview mirror assembly comprises a powerfold exterior sideview mirror assembly.

77. The exterior sideview mirror system of Claim 44, wherein said control comprises a memory controller.

78. The exterior sideview mirror system of Claim 44, wherein at least one of said plano reflective element and said auxiliary reflective element comprises an electro-optic reflective element.

79. The exterior sideview mirror system of Claim 44, wherein both said plano reflective element and said auxiliary reflective element comprise an electro-optic reflective element.

80. The exterior sideview mirror system of Claim 44, wherein said plano reflective element comprises an electro-optical reflective element.

81. The exterior sideview mirror system of Claim 80, wherein said electro-optical reflective element comprises an electrochromic reflective element.

82. The exterior sideview mirror system of Claim 81, wherein said auxiliary reflective element comprises a fixed reflectance mirror reflector.

83. The exterior sideview mirror system of Claim 82, wherein said fixed reflectance mirror reflector comprises a bent glass substrate coated with a metallic reflector coating.

Add
B4

EXTERIOR MIRROR PLANO-AUXILIARY REFLECTIVE ELEMENT ASSEMBLY

ABSTRACT

5 This invention provides a plano-multiradius reflective element assembly suitable for use in an exterior sideview mirror assembly mounted to the side body of an automobile. The plano-multiradius reflective element assembly includes a plano reflective element which has a rearward field of view, when mounted in an exterior sideview mirror assembly mounted to the side body of an automobile, with unit magnification. The plano-multiradius reflective element assembly also includes an auxiliary reflective element including a multiradius portion with a rearward field of view. The plano reflective element 10 provides a distortion-free rearward field of view and serves as the principal rearward-viewing portion of the plano-multiradius reflective element assembly. The multiradius portion provides a wide angle rearward field of view, and typically supplements the rearward field of view of the plano portion. The plano reflective element and the multiradius portion are separated by a demarcation element which enables the driver to readily delineate a rearward 15 view in the plano portion from a rearward view in the multiradius portion. The plano reflective element and the multiradius reflective element are individually, separately, and adjacently attached to a single backing plate which is mounted to an actuator of the exterior sideview mirror assembly. By adjusting the position of the backing plate within the housing of the exterior sideview mirror assembly via the actuator, the rearward field of view of both 20 the plano reflective element and the multiradius reflective element are simultaneously and similarly aligned.

003010-51634160

PRINT OF DRAWING
AS ORIGINALLY

Shafter
359
871

SMR USA
Exhibit 1029
Page 045

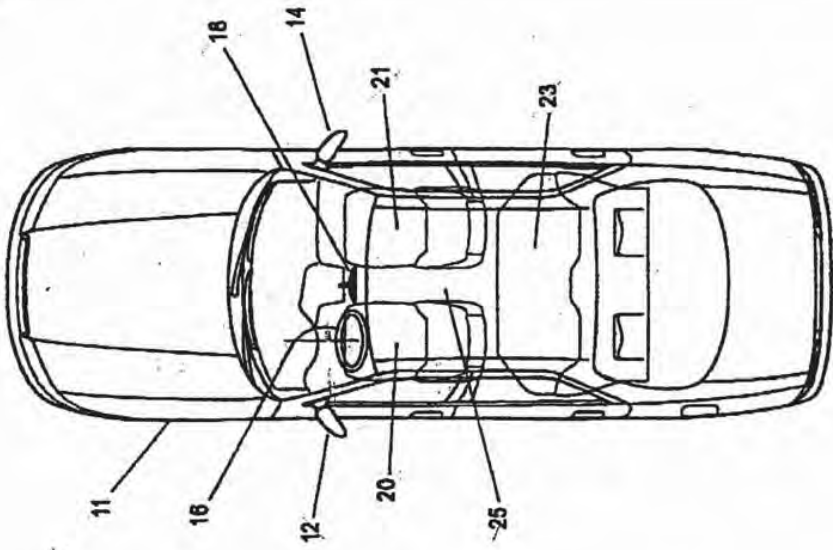

Figure 1

PRINT OF DRAWING
AS ORIGINALLY FILED

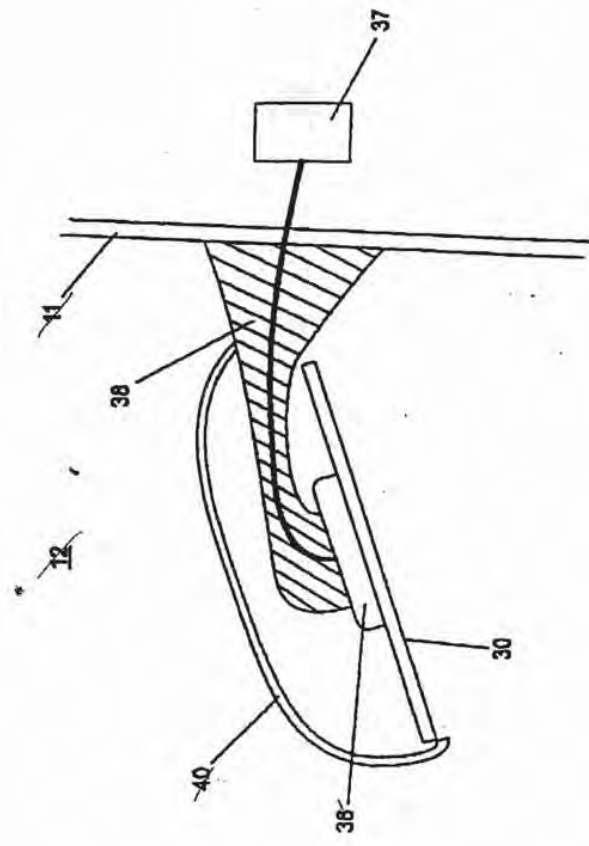

Figure 2

PRINT OF DRAWING
AS ORIGINALLY

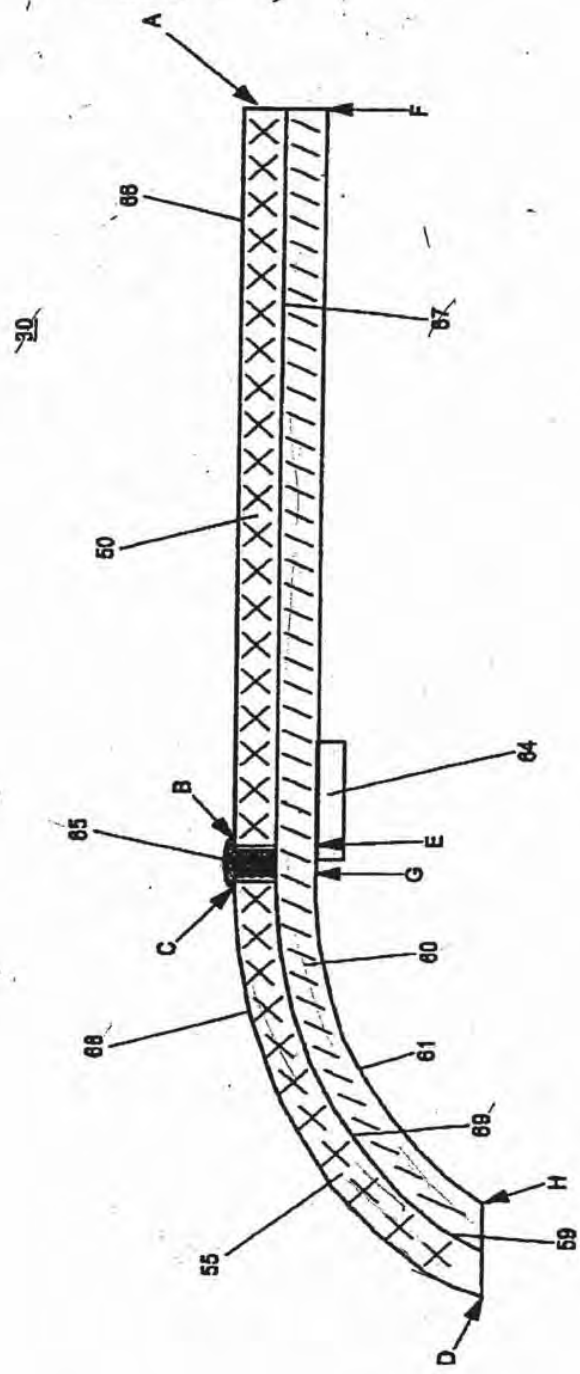

Figure 3

PRINT OF DRAWING
AS ORIGINALLY FILED

SMR USA
Exhibit 1029
Page 048

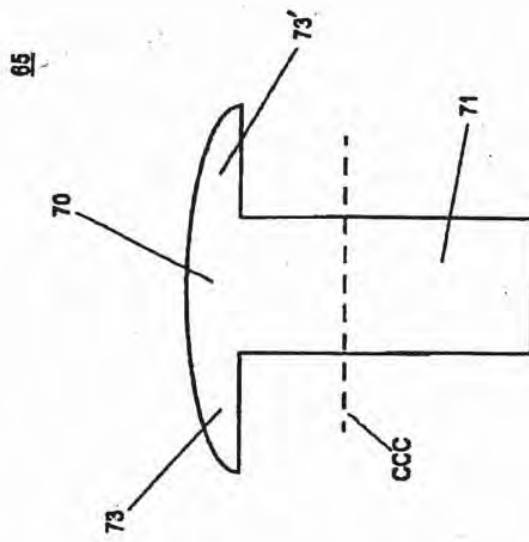
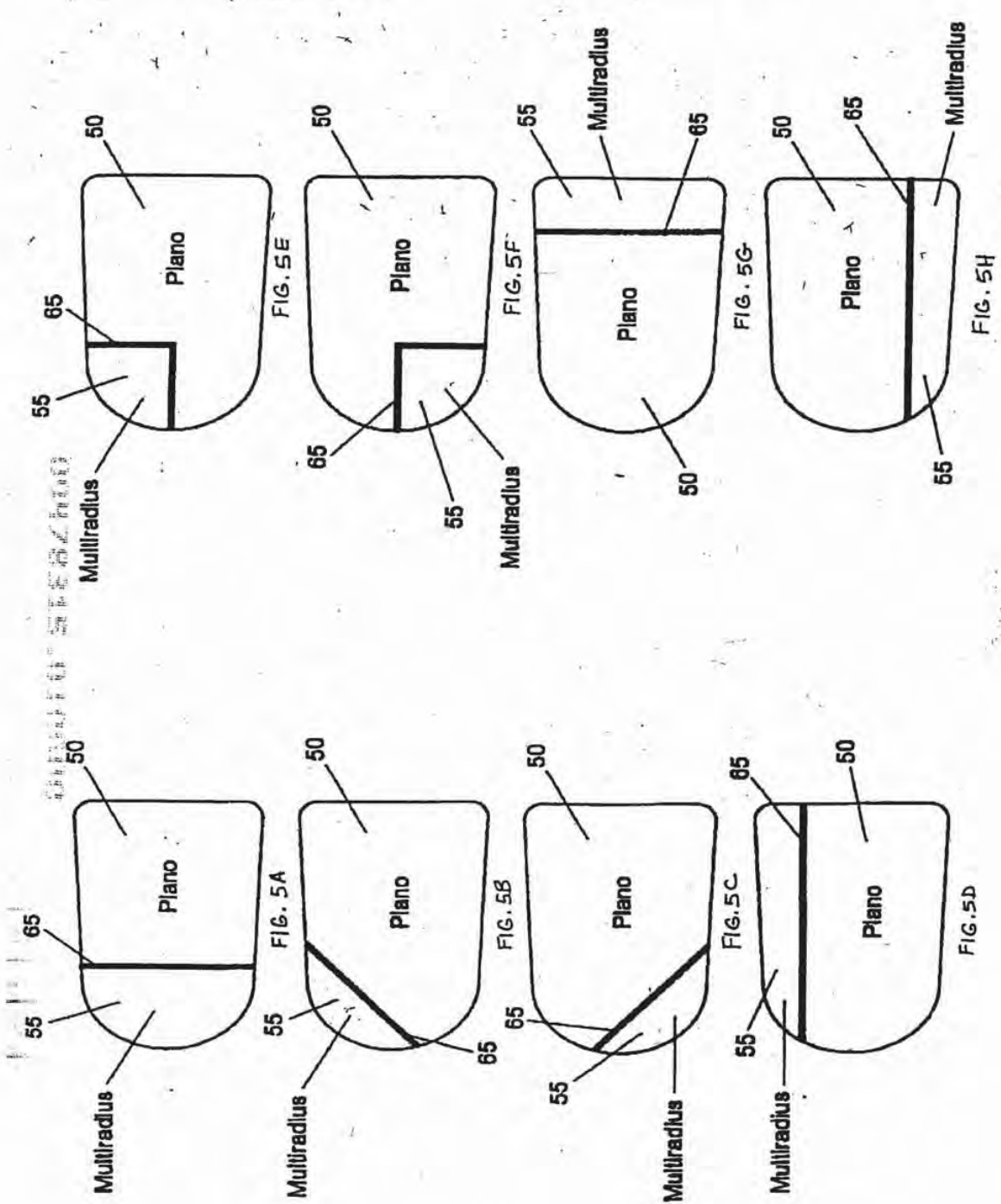

Figure 4



PRINT OF DRAWING
AS ORIGINALLY INTENDED

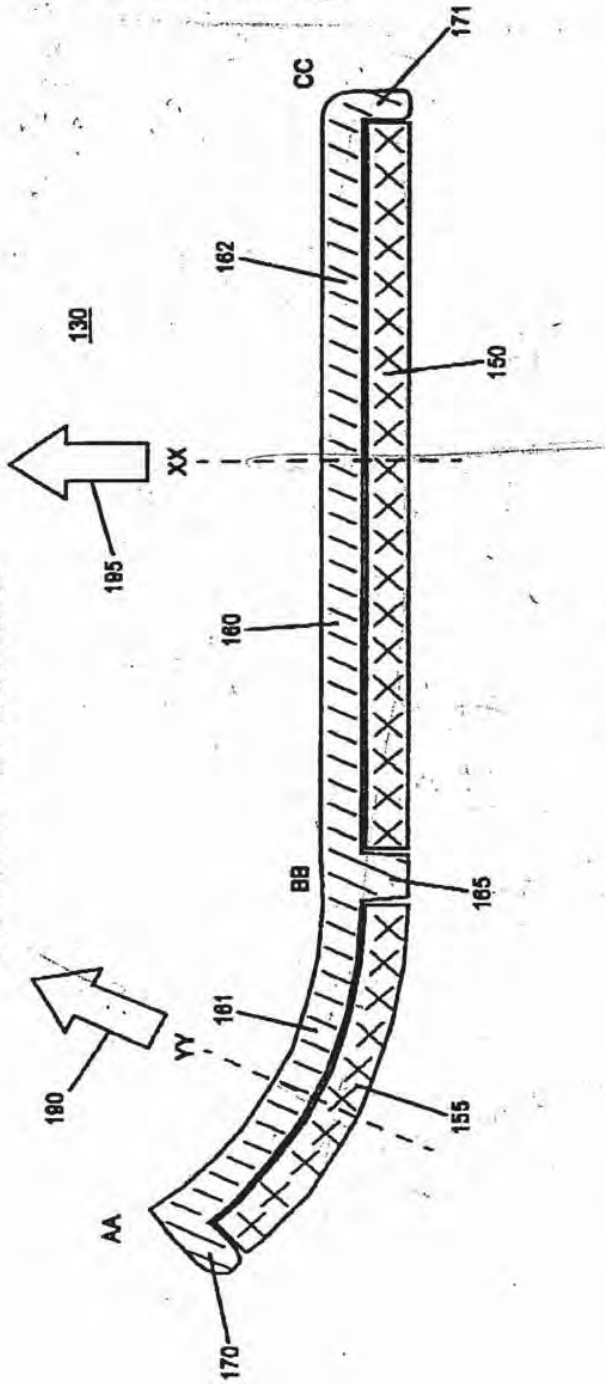

Figure 6

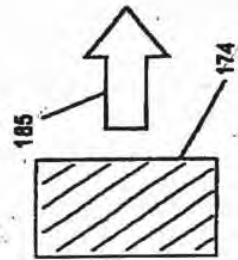

Figure 6A

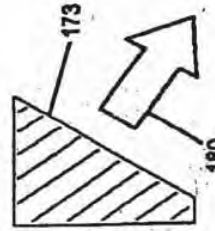

Figure 6B

PRINT OF DRAWING
AS ORIGINALLY FILED

U.S. PATENT AND TRADEMARK OFFICE
WASHINGTON, D.C. 20540

230

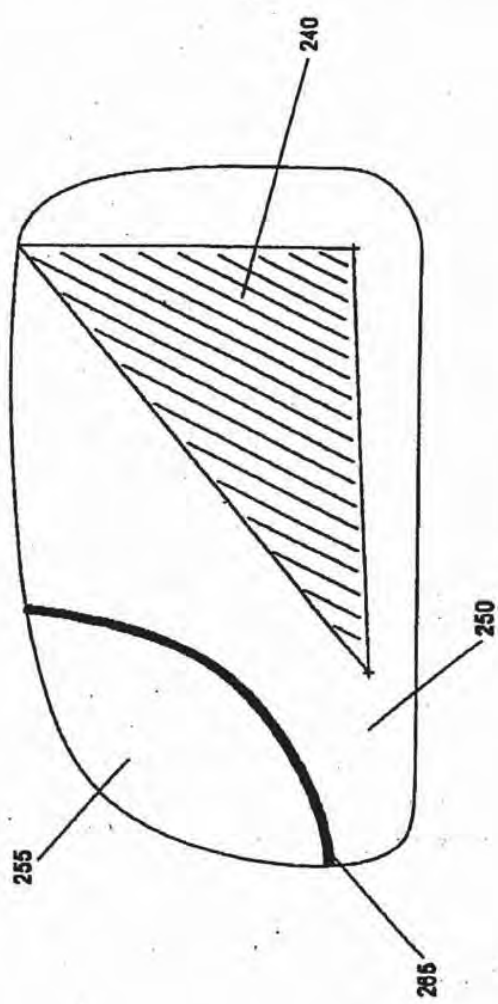

Figure 7

10

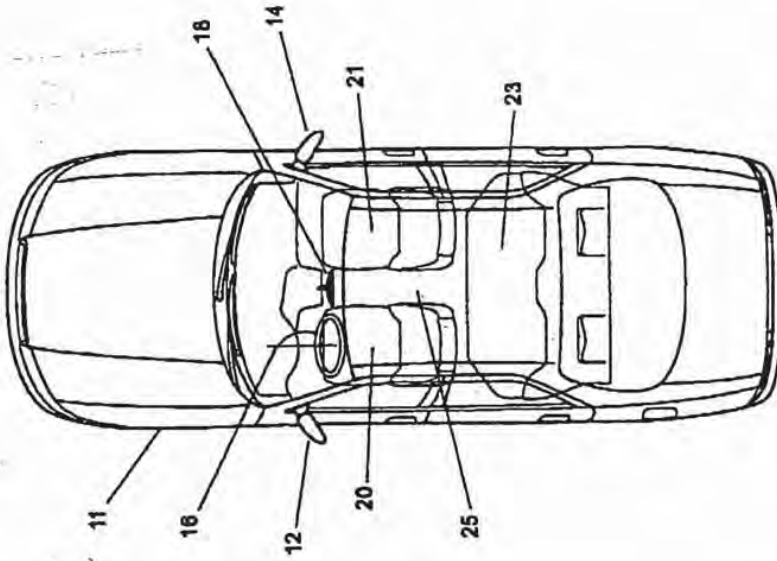

Figure 1



Applicant : Niall R. Lynam
For : EXTERIOR MIRROR PLANO-
AUXILIARY REFLECTIVE
ELEMENT ASSEMBLY
Docket No. : DON01 P-793
Express Mail No. EL399135945US
Sheet : 1 of 7

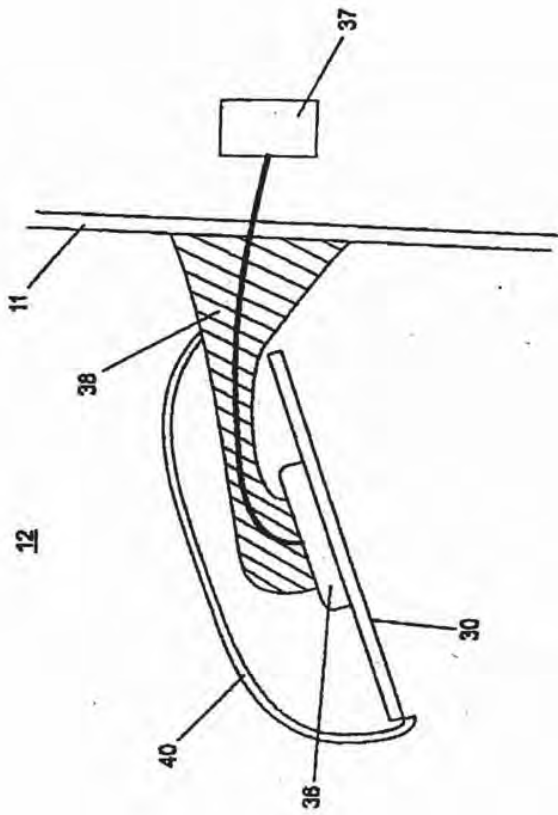

Figure 2

Applicant : Niall R. Lynam
For : EXTERIOR MIRROR PLANO-
AUXILIARY REFLECTIVE
ELEMENT ASSEMBLY
Docket No. : DON01 P-793
Express Mail No. EL399135945US
Sheet : 2 of 7

30

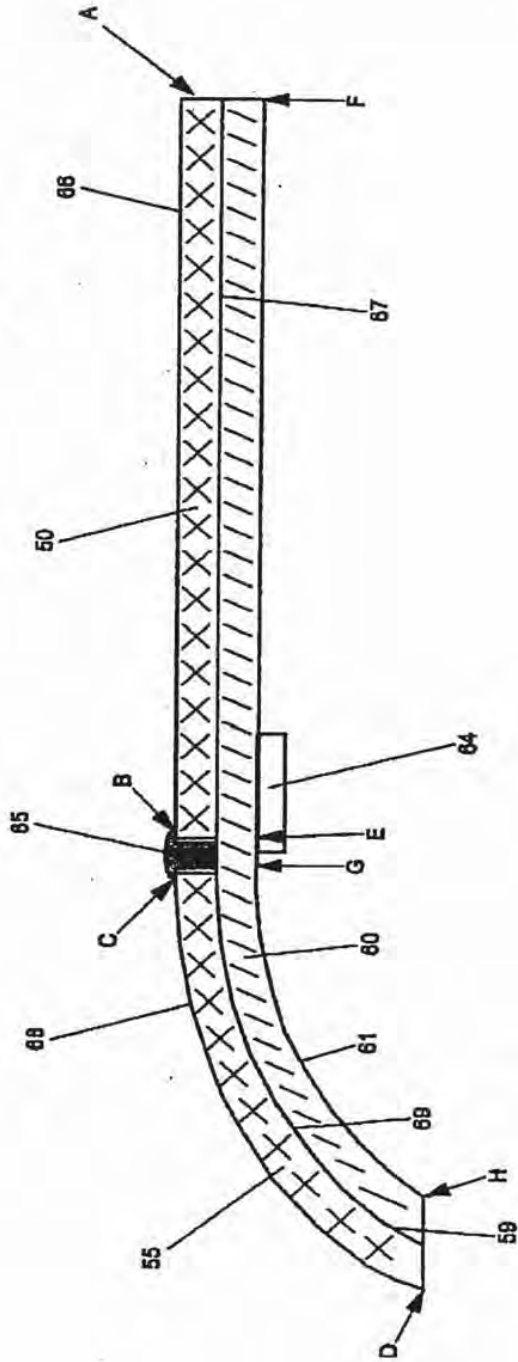

Figure 3

Applicant : Niall R. Lynam
For : EXTERIOR MIRROR PLANO-
AUXILIARY REFLECTIVE
ELEMENT ASSEMBLY
Docket No. : DON01 P-793
Express Mail No. : EL399135945US
Sheet : 3 of 7

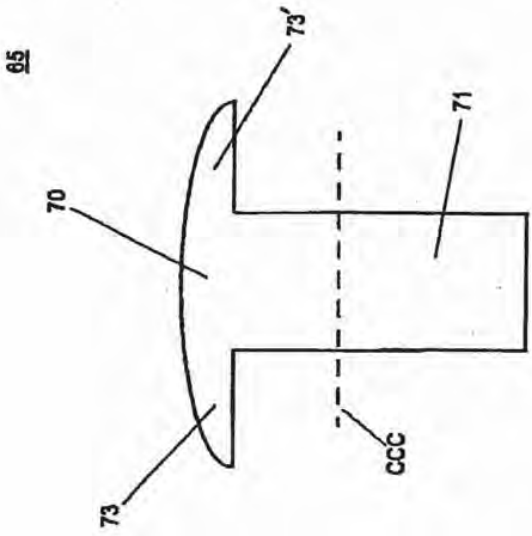

Figure 4

Applicant : Niall R. Lynam
For : EXTERIOR MIRROR PLANO-
AUXILIARY REFLECTIVE
ELEMENT ASSEMBLY
Docket No. : DON01 P-793
Express Mail No. EL399135945US
Sheet : 4 of 7

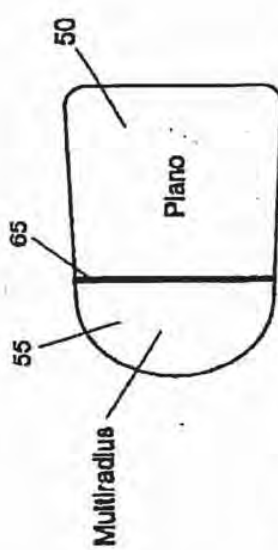

FIG. 5A

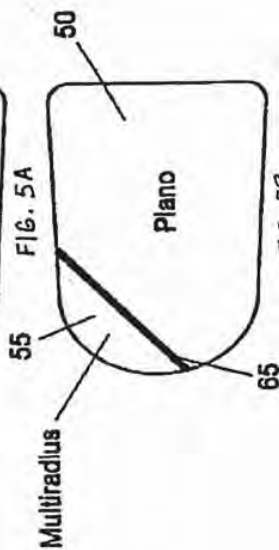

FIG. 5B

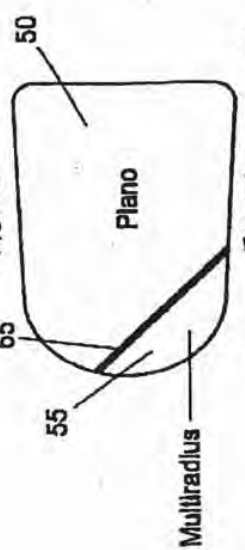

FIG. 5C

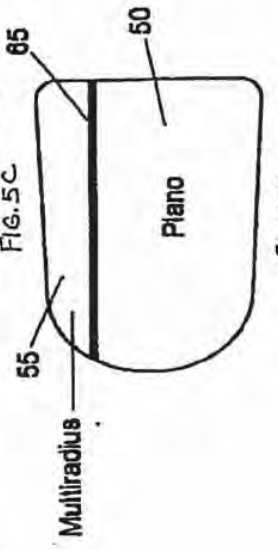

FIG. 5D

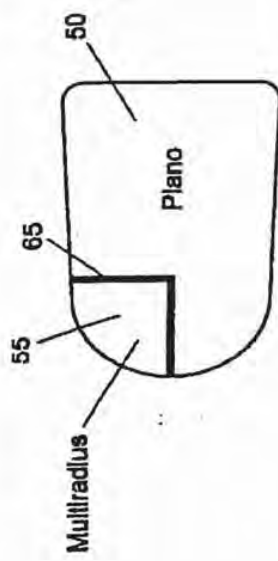

FIG. 5E

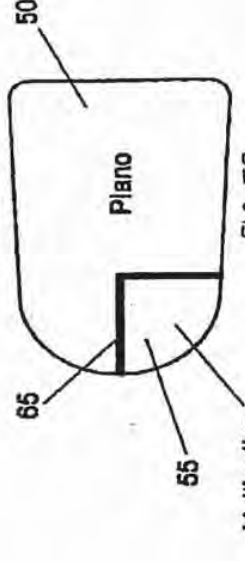

FIG. 5F

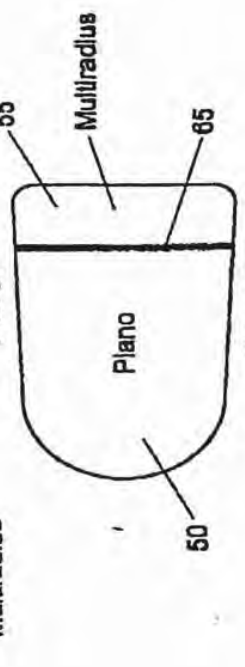

FIG. 5G

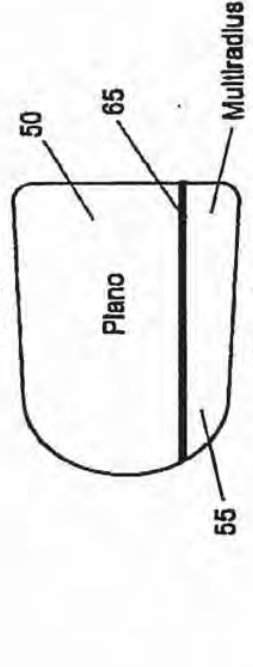

FIG. 5H

Applicant : Niall R. Lynam
For : EXTERIOR MIRROR PLANO-
AUXILIARY REFLECTIVE
ELEMENT ASSEMBLY
Docket No. : DON01 P-793
Express Mail No. EL399135945US
Sheet : 5 of 7

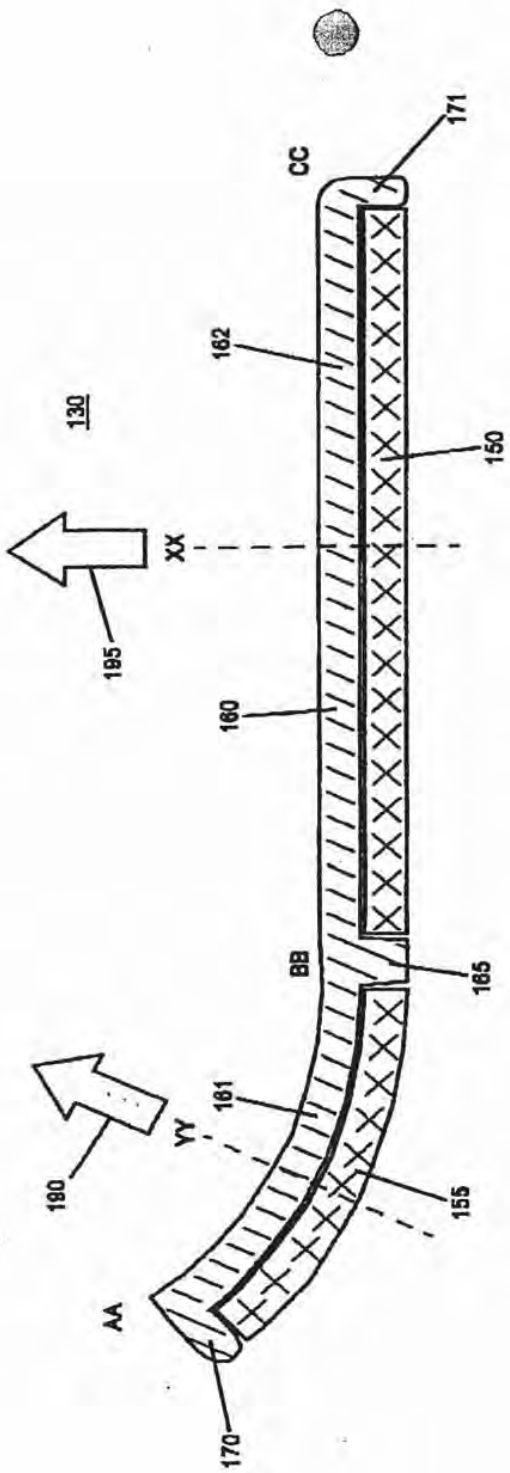

Figure 6

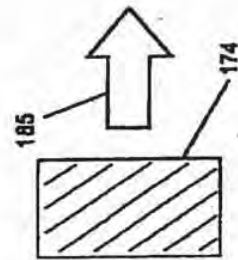

Figure 6A

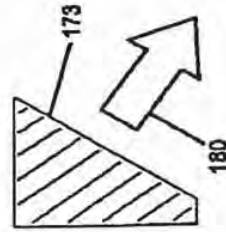

Figure 6B

Applicant : Niall R. Lynam
For : EXTERIOR MIRROR PLANO-
AUXILIARY REFLECTIVE
ELEMENT ASSEMBLY
Docket No. : DON01 P-793
Express Mail No. : EL399135945US
Sheet : 6 of 7

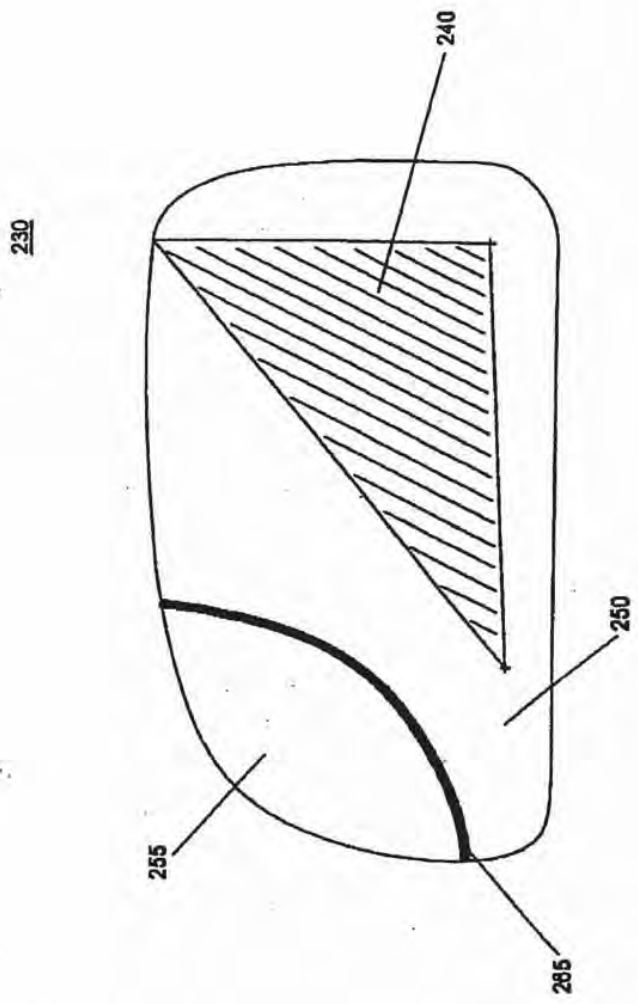

Figure 7

Applicant : Niall R. Lynam
For : EXTERIOR MIRROR PLANO-
AUXILIARY REFLECTIVE
ELEMENT ASSEMBLY
Docket No. : DON01 P-793
Express Mail No. : EL399135945US
Sheet : 7 of 7



#2/IOS
4/14/00
C. McKinney
PATENT
DON01 P-793

IN THE UNITED STATES PATENT AND TRADEMARK OFFICE

Applicant : Niall R. Lynam
Serial No. : 09/478,315
Filing Date : January 6, 2000
Group Art : 2872
For : EXTERIOR MIRROR PLANO-AUXILIARY
REFLECTIVE ELEMENT ASSEMBLY

Assistant Commissioner for Patents
Washington, D.C. 20231

RECEIVED
JUL 13 2000
TC 2806 MAIL ROOM

Dear Sir:

INFORMATION DISCLOSURE STATEMENT

In accordance with 37 CFR 1.51, 1.56, 1.97 and 1.98, Applicant submits herewith patents, publications or other information listed on attached Form PTO-1449 for consideration by the Examiner in connection with examination of the present application.

This Information Disclosure Statement is being filed: (a) within three months of the filing date of the national application; (b) within three months of the date of entry of the national stage as set forth in 37 CFR § 1.491 in the corresponding international application; or (c) before the Applicant is aware of any mailing date of a first Office Action on the merits, whichever occurs last.

This Information Disclosure Statement is not intended to constitute an admission that any patent, publication or other information referred to herein is "prior art" for this invention unless specifically designated as such.

Under 37 CFR 1.97(h), the filing of this Information Disclosure Statement shall not be construed to mean that a search has been made or that no other material information as defined in 37 CFR 1.56(a) exists.

Applicant : Niall R. Lynam
Serial No. : 09/478,315
Page : 2

An early and favorable action on the merits is respectfully requested.

Respectfully submitted,

NIALL R. LYNAM

By: Van Dyke, Gardner, Linn & Burkhart, LLP

July 5, 2020
Date

Catherine S. Collins
Catherine S. Collins
Registration No. 37 599
P.O. Box 888695
Grand Rapids, Michigan 49588-8695
(616) 975-5500

CSC:lmsc

FORM PTO-1449 U.S. DEPARTMENT OF COMMERCE (Rev. 2-32) PATENT AND TRADEMARK OFFICE INFORMATION DISCLOSURE STATEMENT BY APPLICANT (Use several sheets if necessary)	ATTY. DOCKET NO. DON01 P-793	SERIAL NO. 09/478,315
	APPLICANT Niall R. Lynam	
	FILING DATE January 6, 2000	GROUP 2872



U.S. PATENT DOCUMENTS

EXAMINER INITIAL	DOCUMENT NUMBER	DATE	NAME	CLASS	SUB-CLASS	FILING DATE IF APPROPRIATE	
						Y	N
MS	5 7 5 1 4 8 9	05/12/1998	Caskey et al.	359	603		
MS	5 9 1 0 8 5 4	06/08/1999	Varaprasad et al.	359	273		
MS	5 7 2 4 1 8 7	03/03/1998	Varaprasad et al.	359	608		
MS	5 6 6 8 6 6 3	09/16/1997	Varaprasad et al.	359	608		
MS	5 5 5 0 6 7 7	08/27/1996	Schofield et al.	359	604		
MS	5 2 3 9 4 0 5	08/24/1993	Varaprasad et al.	359	272		
MS	4 4 4 9 7 8 6	05/22/1984	McCord	350	293		

FOREIGN PATENT DOCUMENTS

EXAMINER INITIAL	DOCUMENT NUMBER	DATE	COUNTRY	CLASS	SUB-CLASS	TRANSLATION	
						Y	N

OTHER DOCUMENTS (Including Author, Title, Date, Pertinent Pages, Etc.)

EXAMINER INITIAL	
MS	U.S. Pat. Ser. No. 09/350,930, filed July 12, 1999, entitled ELECTROCHROMIC POLYMER SOLID FILMS, MANUFACTURING ELECTROCHROMIC DEVICES USING SUCH FILMS, AND PROCESSES FOR MAKING SUCH SOLID FILMS AND DEVICES, by Applicants Desraj V. Varaprasad et al.

EXAMINER	MS	DATE CONSIDERED	4/02/01
EXAMINER: Initial if citation considered, whether or not citation is in conformance with MPEP 609; Draw line through citation if not in conformance and not considered. Include copy of this form with next communication to applicant.			

DONOR P-593



US005751489A

United States Patent [19]

Caskey et al.

[11] Patent Number: 5,751,489

[45] Date of Patent: May 12, 1998

[54] ELEMENTAL SEMICONDUCTOR MIRROR FOR VEHICLES

[75] Inventors: Gregory T. Caskey; Niall R. Lynam, both of Holland, Mich.; Bryant P. Hichwa, Santa Rosa, Calif.

[73] Assignee: Donnelly Corporation, Holland, Mich.

[21] Appl. No.: 409,279

[22] Filed: Mar. 23, 1995

Related U.S. Application Data

[62] Division of Ser. No. 700,760, May 15, 1991, Pat. No. 5,335,056.

[51] Int. Cl.⁶ G02B 5/08; G02B 5/26; G02B 7/182; G02B 1/10

[52] U.S. Cl. 359/603; 359/883; 359/884; 359/585; 359/584; 359/589; 359/608; 437/81; 437/238; 437/240

[58] Field of Search 359/603, 883, 359/884, 585, 584, 589, 608; 437/81, 238, 240, 233

[56] References Cited

U.S. PATENT DOCUMENTS

2,427,689	9/1947	Osterberg et al.	359/370
2,478,817	8/1949	Gaiser	359/488
2,519,722	8/1950	Tumer	359/584
2,590,906	4/1952	Tripp	359/584
2,715,352	8/1955	Jobe	359/211
2,750,832	6/1956	Morgan	359/585
2,999,034	9/1961	Heidenhain	427/167

(List continued on next page.)

FOREIGN PATENT DOCUMENTS

3436016 4/1988 Germany

OTHER PUBLICATIONS

"Blue Mirror" vehicular rearview mirror element on sale in the United States for more than one year by Donnelly Corporation, Holland, Michigan, illustrated and described in attached Appendix A.

Primary Examiner—Paul M. Dzierzynski
Assistant Examiner—Mohammad Y. Sikder
Attorney, Agent, or Firm—Van Dyke, Gardner, Linn & Burkhart, LLP

[57] ABSTRACT

A elemental mirror for vehicles having a luminous reflectance of at least about 30% includes a substrate coated with a thin layer of elemental semiconductor having an index of refraction of at least 3 and an optical thickness of at least about 275 angstroms. Preferably, the elemental semiconductor coating is sputter coated silicon or germanium and a light absorbing coating is included therebehind. The mirror is spectrally nonselective with elemental semiconductor optical thicknesses of about 275 to 2400 angstroms on the front substrate surface. Spectrally selective mirrors are provided by adding an interference coating to the elemental semiconductor layer coating, preferably of a dielectric such as silicon dioxide or silicon nitride, on either the front or rear substrate surface, or by using a thicker, single elemental semiconductor layer. Instead of an absorbing coating behind the mirror, additional elemental semiconductor and dielectric thin layers may be included to reduce secondary reflections. The method includes coating the thin elemental semiconductor layer on flat glass and heating to harden the layer and make it more scratch resistant, or heating and bending the glass without destroying the reflective properties of the mirror. The thin interference layer, secondary reflection reducing layers, and/or light absorbing coating may be coated before or after heating and bending.

103 Claims, 7 Drawing Sheets

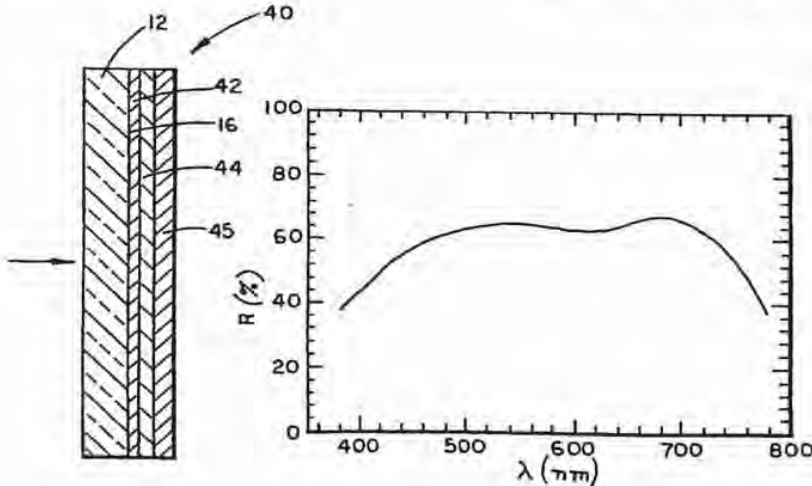

U.S. PATENT DOCUMENTS

3,412,575	11/1968	Feldman et al.	63/2	4,444,467	4/1984	Shuskus et al.	359/846
3,556,640	1/1971	Anstin	359/582	4,490,227	12/1984	Bitter	204/192.14
3,559,090	1/1971	Refermat et al.	359/583	4,490,228	12/1984	Bodin et al.	204/192.14
3,652,318	3/1972	Heins	427/167	4,545,646	10/1985	Chern et al.	359/569
3,671,286	6/1972	Fischell	428/332	4,627,732	12/1986	Braun et al.	356/350
3,679,291	7/1972	Apfel et al.	D16225	4,673,248	6/1987	Iaguchia et al.	359/584
3,826,728	7/1974	Chambers et al.	204/192.27	4,715,879	12/1987	Schmitte et al.	65/60.2
3,834,793	9/1974	McConnell et al.	359/289	4,805,989	2/1989	Nakajima	296/216
3,925,182	12/1975	Carmichael et al.	204/192.27	4,857,094	8/1989	Groth et al.	65/60.2
3,926,508	12/1975	Harnsen et al.	359/884	4,870,322	9/1989	Matsudaira et al.	313/506
3,934,061	1/1976	Keck et al.	427/163.2	4,921,331	5/1990	Nakajima et al.	359/584
4,048,039	9/1977	Daxinger	204/192.28	4,955,705	9/1990	Nakajima et al.	359/884
4,144,684	3/1979	Kirkbride et al.	52204.5	5,007,710	4/1991	Nakajima et al.	359/589
4,320,155	3/1982	Gillery	427/160	5,072,109	12/1991	Aguilera et al.	359/359
4,322,130	3/1982	Ito et al.	359/584	5,171,414	12/1992	Amberger et al.	204/192.26
4,388,344	6/1983	Shuskus et al.	359/846	5,179,471	1/1993	Caskey et al.	359/603

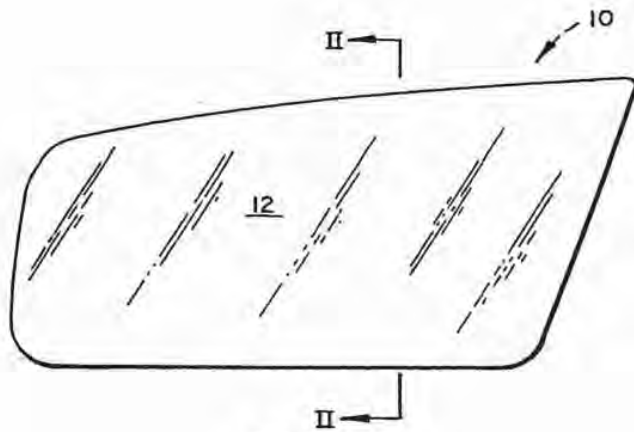

FIG. 1

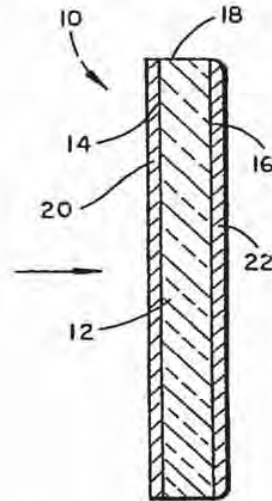

FIG. 2

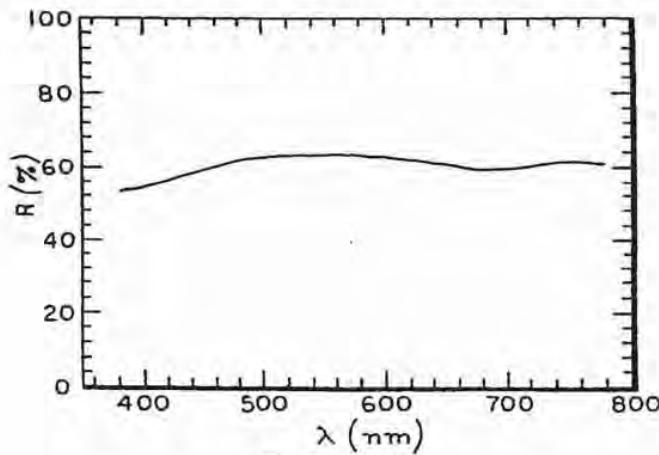

FIG. 3

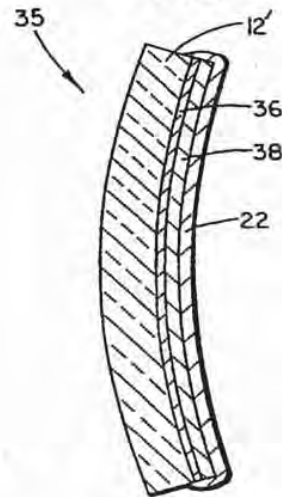

FIG. 7A

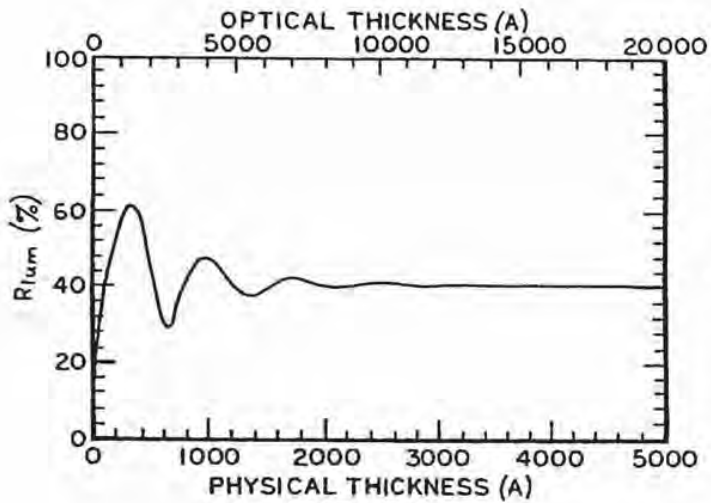

FIG.4

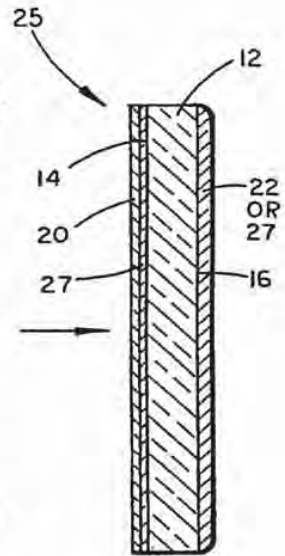

FIG.5

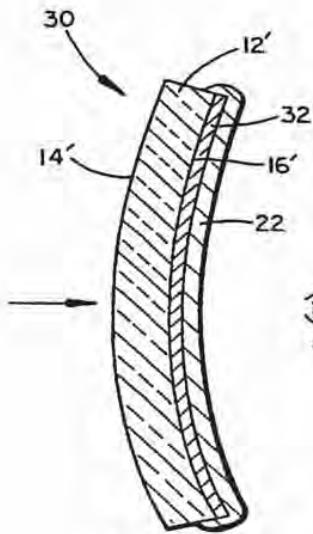

FIG.6

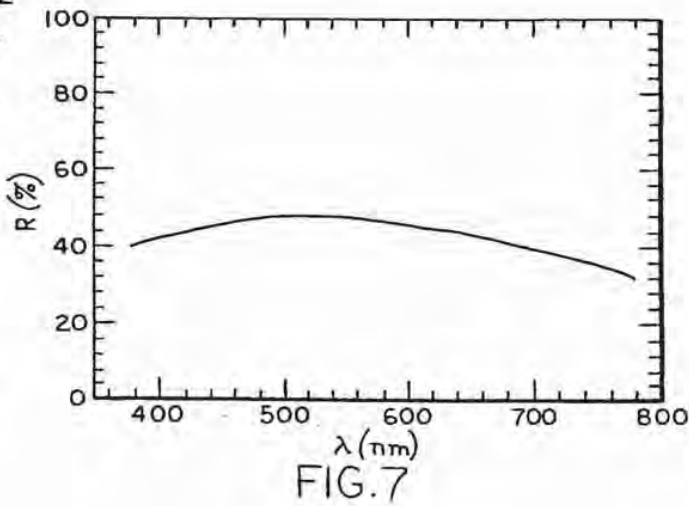

FIG.7

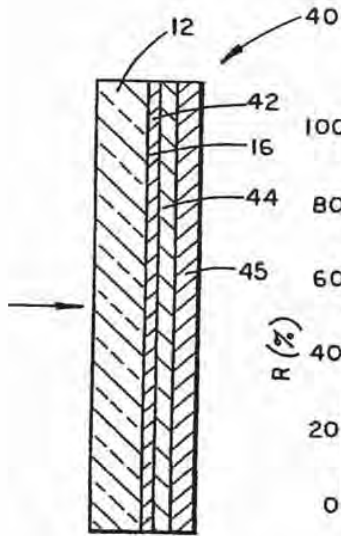

FIG. 8

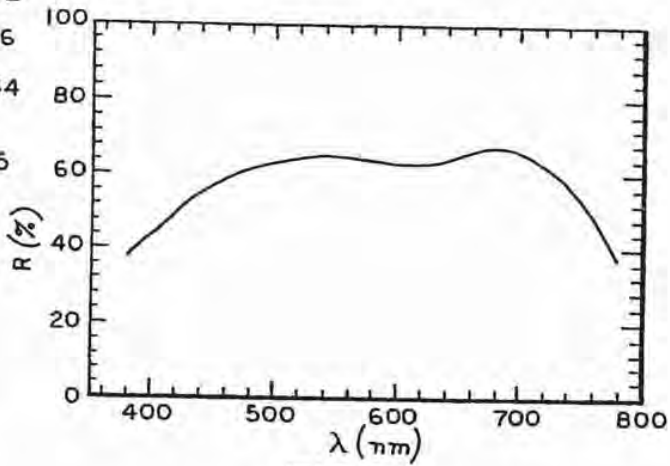

FIG. 9

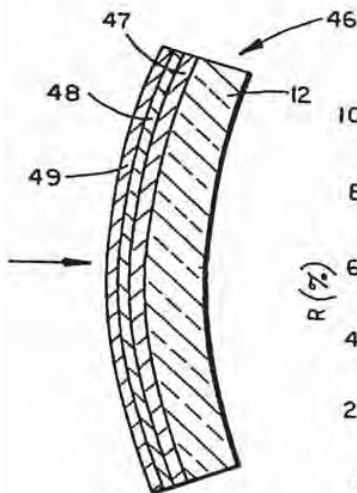

FIG. 9A

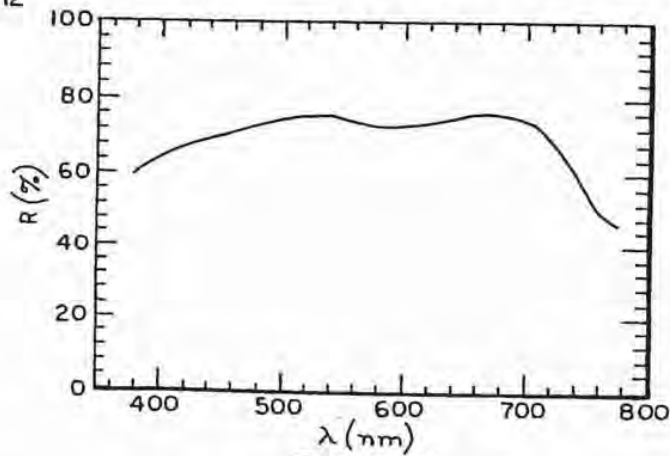

FIG. 9B

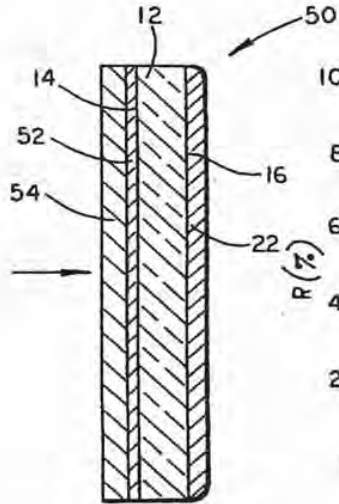

FIG. 10

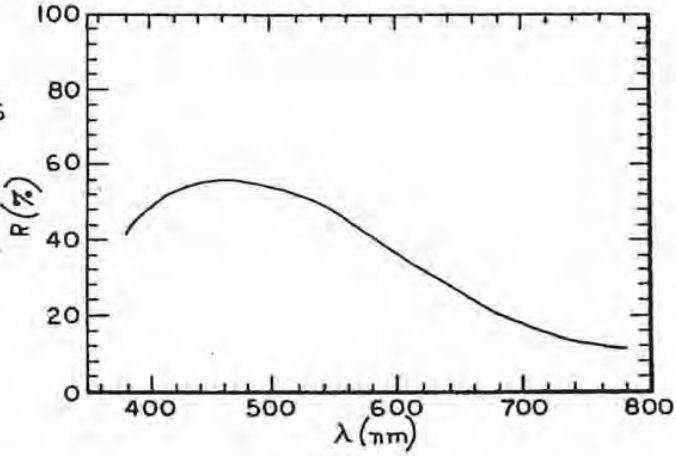

FIG. 12

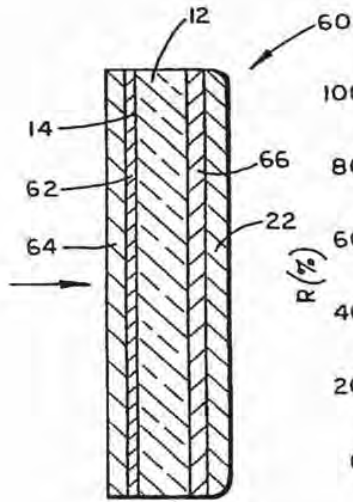

FIG. 11

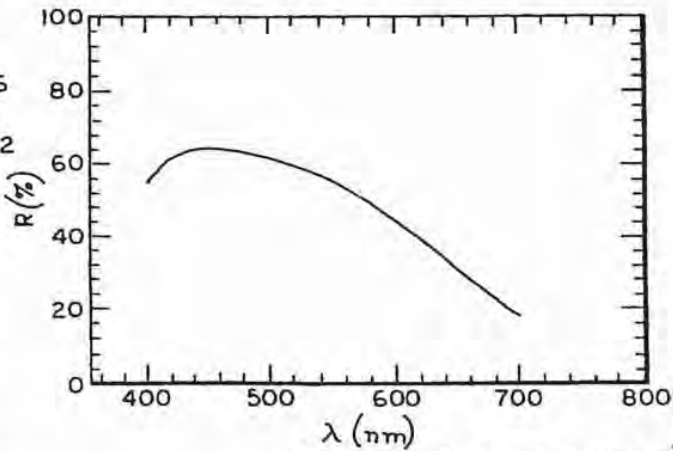

FIG. 13 (PRIOR ART)

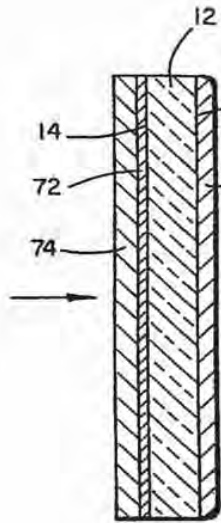

FIG. 14

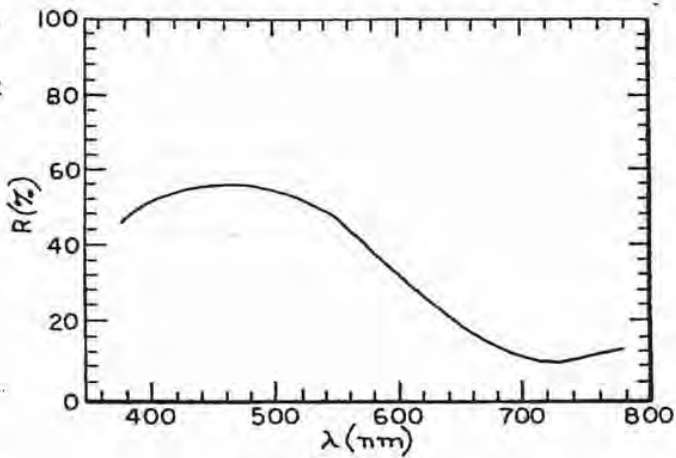

FIG. 15

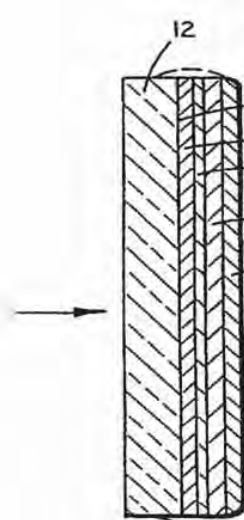

FIG. 16

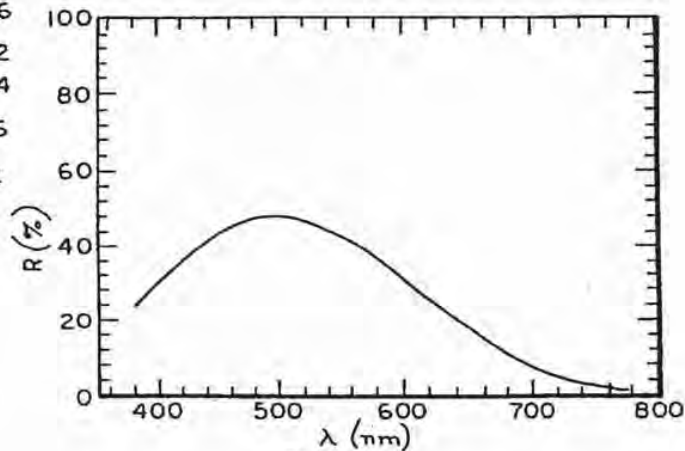

FIG. 17

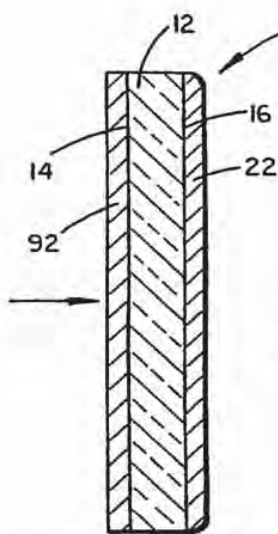

FIG. 18

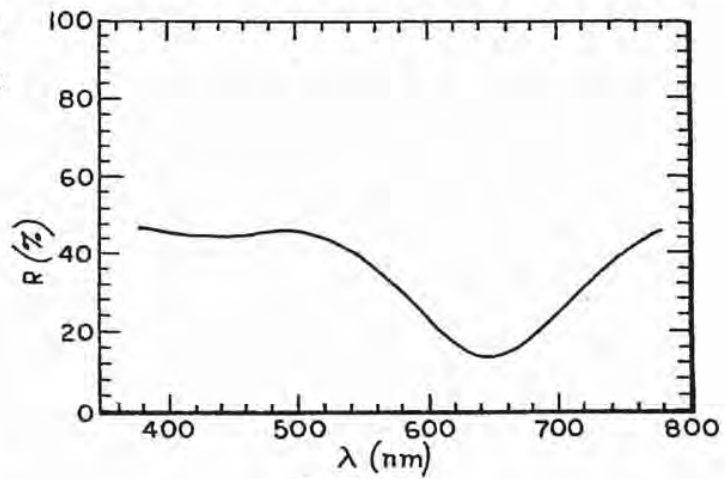

FIG. 19

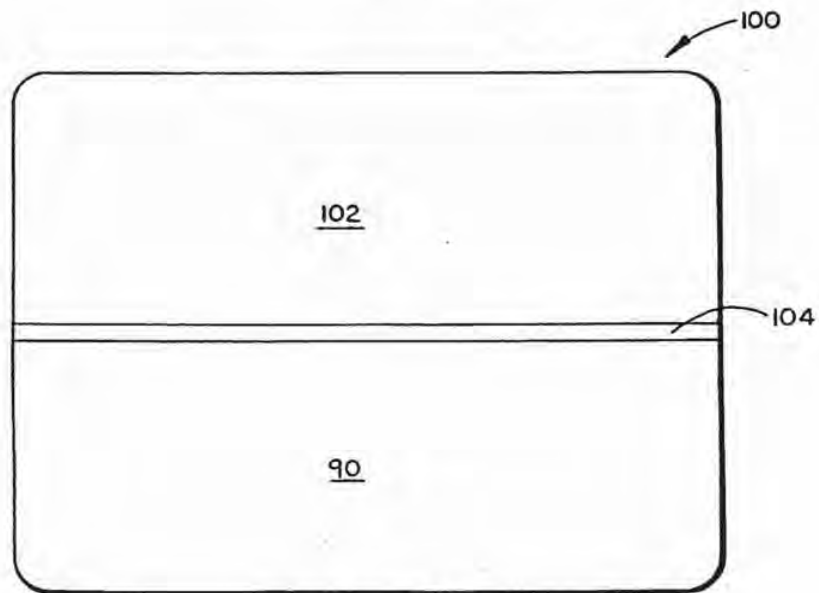

FIG. 20

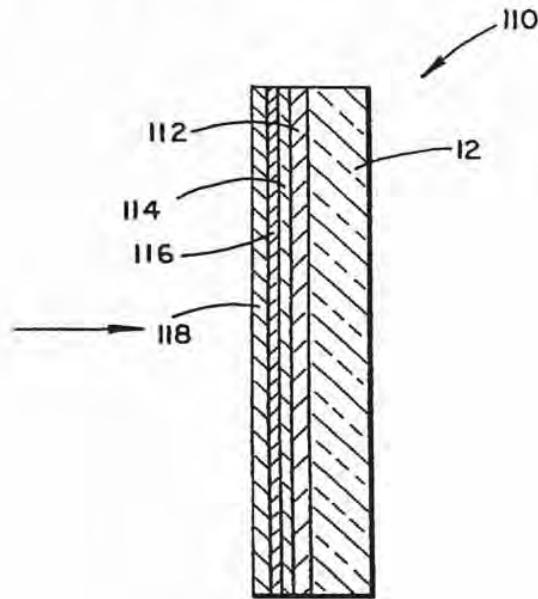

FIG. 21

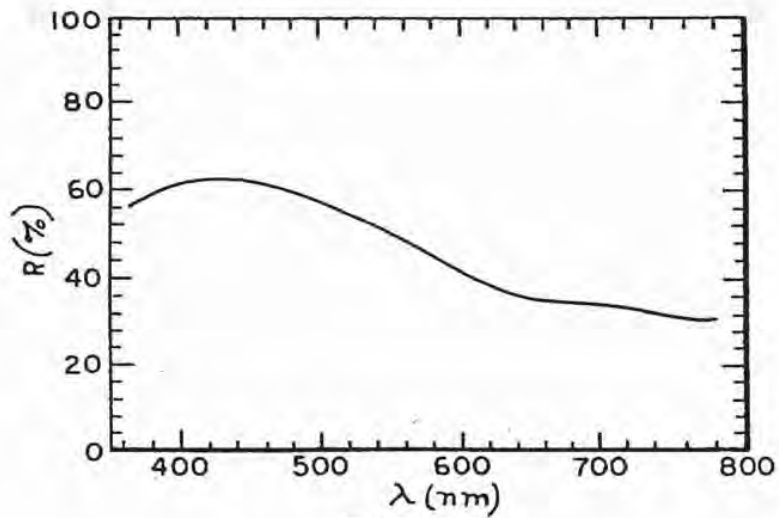

FIG. 22

ELEMENTAL SEMICONDUCTOR MIRROR FOR VEHICLES

CROSS REFERENCE TO RELATED APPLICATION

This application is a division of application Ser. No. 07/700,760, filed May 15, 1991, by Gregory T. Caskey, Niall R. Lynam, and Bryant P. Hichwa, entitled METHOD FOR MAKING ELEMENTAL SEMICONDUCTOR MIRROR FOR VEHICLE U.S. Pat. No. 5,535,056.

BACKGROUND OF THE INVENTION

This invention relates to vehicular mirrors and, more particularly, to rearview mirrors for vehicles which incorporate a thin layer of an elemental semiconductor to provide luminous reflectance levels adapted to reduce glare while maintaining visibility.

Vehicular rearview mirrors, especially for the exterior of an automobile or truck, are broadly classified as either spectrally nonselective, i.e., achromatic, metallic or silvery in appearance, or spectrally selective, i.e., those which use light interference to enhance reflectance in some portion of the visible wavelength spectrum relative to other portions. For example, a commonly available first surface, chromium coated glass mirror is a spectrally nonselective or metallic appearing mirror. Commercially available blue mirrors which enhance reflection in the blue region of the visible spectrum are exemplary of spectrally selective mirrors.

It is desirable in both spectrally nonselective and selective vehicular mirrors to reduce glare and provide an antidazzling effect while maintaining sufficient luminous reflectance to provide a proper image. Such an image is bright enough that the driver can quickly, accurately and easily gather information about the environment even in low light level conditions, but not so bright as to act as a source of glare from following headlights at night. Luminous reflectance of rearview mirrors is measured by using a light source which models that from a headlight and by using a detector with a filter which mimics the spectral selectivity of the human eye in its day adapted (photopic) mode. Measurements of luminous reflectance are performed in accordance with SAE (Society of Automotive Engineers) Recommended Practice J964 for measurement of rearview mirror reflectivity. In the United States, governmental regulations such as Federal Motor Safety Standard 111 require a minimum mirror luminous reflectance of at least 35%. In Europe, European Economic Community Council Directive 71/127/EEC requires a similar minimum luminous reflectance of at least 40% for vehicular mirrors. On the other hand, a maximum luminous reflectance of 60% to 65% has been found acceptable for glare reducing rearview mirrors as compared to the luminous reflectance of a full reflectivity mirror of about 80% to 90% of the incident light.

In addition, spectrally selective mirrors may be used to further optimize human sight in low light level or night conditions. As indicated above, luminous mirror reflectance depends both on the type of light source projecting light on a mirror as well as the type of detector which senses the reflected light. The human eye is a detector which adapts to various levels of ambient light by changing its sensitivity to various colors. During the day when light is abundant, human eye sensitivity is highest in the green spectral regions. As light level drops, however, the peak eye sensitivity moves toward the shorter, blue wavelengths. Since headlights have a spectral emission that is strong in longer yellow wavelengths but weaker in blue, a glare-reducing or

antidazzling mirror which optimizes low light vision should accentuate reflectance in the blue regions [400 to 500 nm. wavelengths or thereabouts] where the eye is most sensitive but reduce reflectance in the yellow regions [above 560 nm. wavelengths or thereabouts] thereby reducing headlight reflectance. Such a mirror is, therefore, spectrally selective and blue in color.

In the past, both spectrally selective and spectrally non-selective vehicular mirrors have employed coatings of metal, dielectric materials or combinations thereof on glass or other substrates. While such metal/dielectric layers have functioned adequately, various embodiments have been expensive to manufacture due to the necessary coating, cutting, bending and heating procedures. Moreover, in many prior known mirrors, substantial thicknesses of metal or dielectric coatings have been required to provide optical thicknesses necessary for proper reflectance or spectral selectivity. Increased thicknesses require additional material and add expense to production costs.

Also, many vehicle manufacturers specify first surface mirrors on the vehicle exterior in order to reduce ghost or secondary reflections and images. In such mirrors, the reflective coatings are exposed to the elements and can degrade more quickly than second surface mirrors.

Moreover, the manufacturing processes necessary to make prior known spectrally selective and nonselective mirrors have often required costly, time consuming procedures which require heating and bending of glass prior to applying any coating. As is well known, the coating of a curved substrate with a uniform thickness thin layer is more difficult, time consuming and expensive than coating flat glass because of special fixturing required and the difficulties of cleaning curved surfaces, for example. Again, such procedures increase production costs.

Further, the production of prior known spectrally selective and nonselective mirrors has often required greatly differing combinations of layers and materials. The use of one or a few types of layers to produce spectrally selective as well as nonselective vehicular mirrors was difficult. Hence, modifying production techniques to incorporate the varying types of materials and to switch between the differing materials at different times reduced production efficiency and added to costs.

Thus, the need has remained for a commercially acceptable vehicular mirror which can be economically produced from a material which provides both spectrally selective and nonselective mirrors, allows use on both first and second surface mirrors, and provides luminous reflectances meeting worldwide minimum safety standards while maintaining desired glare reduction.

SUMMARY OF THE INVENTION

Accordingly, the present invention provides a solution to the above needs with a glare-reducing mirror for vehicles having a luminous reflectance of between about 30% and 65% to achieve consumer and regulatory acceptability with either spectrally selective or nonselective mirrors. The invention achieves this result through the use of a thin layer of an elemental semiconductor which may be used alone in varying thicknesses or combined with interference coatings preferably of a dielectric material, thereby producing both spectrally selective and nonselective mirrors.

Use of elemental semiconductors provides high refractive indexes allowing suitable optical thicknesses with thinner material layers and, therefore, increased production economies. Optical thickness is important in the present invention

because optical thickness controls the interference of light which produces the desired spectral response in the mirrors herein. In addition, manufacturing flexibility is provided since the semiconductor layers can be provided in varying thicknesses for use on either first or second surface mirrors, for spectral selectivity or nonselectivity, for combination with interference coatings to produce spectrally selective mirrors as well, or for combination with dielectric layers in additional coatings which reduce secondary reflections from the mirror. In addition, the semiconductor and other layers are easily coated on flat glass and subsequently heated to improve their scratch resistance and hardness or heated and bent to produce a curved mirror, all without reducing reflective qualities.

Conventional mirror coatings of metal like silver, aluminum, chromium, titanium, stainless steel or the like do not withstand elevated temperatures in manufacturing or use (e.g., temperatures encountered during bending operations) whereas coatings in the present invention do. Nor do the conventional coatings withstand such conditions even after being deposited in combination with other thin films to form multilayer stacks. Therefore, the present invention utilizes elemental semiconductors such as silicon or germanium as thin film materials that retain beneficial cosmetic, reflective and mechanical (i.e., does not crack or flake off the substrate) properties even after heating to temperatures sufficient to permit bending of the glass substrate.

Some metals, like silver and aluminum, are used only in second-surface vehicular mirror constructions because, without proper protection, they deteriorate rapidly in out-of-doors environments. Such coatings are, therefore, over-coated with paint, tape or the like to protect the metal from exposure to the environment. Scratch resistance is thereby provided by the substrate glass. First surface mirrors use metals like chromium, titanium, stainless steel or the like because such coatings adequately resist scratches and wear and because they do not deteriorate as rapidly as silver and aluminum when exposed to the environment typically encountered outside automobiles or trucks. The present invention is surprisingly and beneficially more resistant to scratching and wear than the conventional mirror coatings and so provides consumer appreciable benefit in first surface embodiments over conventional first surface mirrors in that the coatings of this invention are more rugged when exposed to abrasives such as are found in car washes and the like.

In one form, the invention is a glare-reducing mirror for vehicles comprising a substrate having front and rear surfaces and a thin layer of an elemental semiconductor on one surface of the substrate. The elemental semiconductor coating has an index of refraction of at least 3 and an optical thickness of at least about 275 angstroms. The thin elemental semiconductor layer provides the mirror with a luminous light reflectance of at least about 30% of the light incident thereon from the direction of the front surface of the substrate.

Preferably, the elemental semiconductor is silicon or germanium. When silicon is used in an optical thickness of between about 345 and 2400 angstroms, the elemental semiconductor layer provides a spectrally nonselective mirror with luminous light reflectance between about 30% and 65%. When germanium is used in an optical thickness of between about 275 and 2400 angstroms, a similar spectrally nonselective mirror is produced. However, when the thickness of the elemental semiconductor layer is increased to between about 2400 and 10,000 angstroms, the mirror becomes discernibly spectrally selective.

In another aspect of the invention, a spectrally selective, glare-reducing mirror is provided including a substrate hav-

ing front and rear surfaces and a single, thin layer of an elemental semiconductor and a single, thin, transparent, interference coating on the elemental semiconductor thin layer. Again, the elemental semiconductor thin layer has an index of refraction of at least 3 and an optical thickness of at least about 275 angstroms. The interference coating has an index of refraction within the range of between about 1.3 and 2.7, an optical thickness of at least about 500 angstroms, and is positioned closest to a source of incident light to be reflected by the mirror. Such mirror has a luminous reflectance of at least about 30% of the light incident thereon from the direction of the front substrate surface.

In the above mirror, thinner interference coatings than about 500 angstroms do not give appreciable spectral selectivity. Optical thicknesses between about 1600 and 2800 angstroms are preferred because they result in good spectral selectivity. Above 2800 angstroms, spectral selectivity is maintained with a more complex pattern of maxima and minima appearing in the spectral reflectance.

In a preferred form, the elemental semiconductor thin layer may be applied to the front substrate surface with the interference coating being applied over the semiconductor thin layer. Alternately, when the substrate is transparent, the interference coating may be applied to the substrate rear surface with the semiconductor thin layer being applied over the interference coating to the rear of the substrate. In either case, the elemental semiconductor thin layer may be selected from the group including silicon and germanium while the interference coating is preferably selected from the group including silicon dioxide and silicon nitride. With silicon in an optical thickness between about 345 and 1200 angstroms, and an interference coating of silicon dioxide or silicon nitride having an optical thickness within the range of between about 1600 and 2800 angstroms, the mirror provides a blue colored reflectance.

In all cases, a light absorbing layer may be applied to the rear of the substrate or to the last coating on the coated mirror to prevent secondary reflections that would detract from the performance of the overall mirror. Such layer may be chosen to provide anti-scatter protection for pieces or fragments of the substrate in the event that the substrate is broken. Alternately, to reduce secondary reflections, additional thin film layers of an elemental semiconductor and a dielectric may be coated on the front or rear surfaces of the other coating layers for opacification or near-opacification of the mirror.

In yet another aspect of the invention, a method for manufacturing a glare-reducing mirror for vehicles includes providing a sheet of flat glass having front and rear surfaces, coating one surface of the sheet with a thin layer of an elemental semiconductor having an index of refraction of at least 3 and a desired optical thickness of at least about 275 angstroms, heating the coated glass to a temperature sufficient to allow bending of the coated glass and bending the heated, coated glass to a desired curvature. Alternately, a thin layer of dielectric material may be coated on the elemental semiconductor layer prior to heating and bending thereby producing a spectrally selective mirror.

Alternatively, the rear surface of the substrate may be coated with a thin layer of dielectric material followed by the thin elemental semiconductor layer prior to heating and bending. In each of these cases, the subsequent heating and bending does not significantly degrade the reflective characteristics of the coated mirror.

In other aspects, the method for manufacturing a glare-reducing mirror for vehicles includes providing a sheet of

flat glass, coating one surface of the sheet with an elemental semiconductor layer as described above, and heating the coated glass for a limited period of time to cause the semiconductor coating to be environmentally resilient, hard and scratch resistant. Alternately, the flat glass may be heated prior to application of the semiconductor coating to also produce the hard, scratch resistant coating result.

In addition, the present method includes coating a flat glass sheet with an elemental semiconductor coating, or an interference coating such as silicon nitride, or coatings of both, on either the front or rear surfaces of the glass, followed by heating and bending the coated glass. After cooling, if only one coating has been applied, the other material can subsequently be coated in a thin layer to produce a glare-reducing mirror.

Accordingly, the present invention provides both spectrally selective and nonselective mirrors using a thin layer of an elemental semiconductor which are more economical to produce while providing commercially acceptable luminous reflectances which also meet minimum governmental standards. The thin elemental semiconductor layer provides environmental resilience and flexibility for use either alone or with dielectric interference coatings resulting in either first or second surface and spectrally selective or nonselective mirrors as desired. Moreover, such coatings may be combined with dielectric layers and other elemental semiconductor layers to produce spectrally selective mirrors, or to produce either spectrally selective or nonselective mirrors that are opacified using thin films. All these stacks of coatings can be heated to improve scratch resistance, or coated on a heated substrate to achieve the same effect, or heated and bent to form curved mirrors.

These and other objects, advantages, purposes and features of the invention will become more apparent from a study of the following description taken in conjunction with the drawings.

BRIEF DESCRIPTION OF THE DRAWINGS

FIG. 1 is a front view of one form of a spectrally nonselective glare-reducing vehicular mirror of the present invention;

FIG. 2 is a sectional view of the mirror of FIG. 1 taken along plane II—II;

FIG. 3 is a graph of the spectral response for a mirror of the type shown in FIGS. 1 and 2 including a silicon reflective layer of an optical thickness of about 1520 angstroms;

FIG. 4 is a graph of the optical interference effects of varying optical thickness on luminous reflectance for elemental silicon thin films on glass, computed using the dispersion of the refractive index.

FIG. 5 is a sectional view of a second embodiment of a spectrally nonselective vehicular mirror of the present invention;

FIG. 6 is a sectional view of a third embodiment of a spectrally nonselective, convex vehicular mirror of the present invention;

FIG. 7 is a graph of the spectral response for the spectrally nonselective mirror of FIG. 6 including an elemental silicon layer of an optical thickness of about 1600 angstroms;

FIG. 7A is a sectional view of a fourth embodiment of a spectrally nonselective, convex vehicular mirror of the present invention;

FIG. 8 is a sectional view of a fifth embodiment of a second surface spectrally nonselective mirror of the present invention;

FIG. 9 is a graph of the spectral response for the mirror of FIG. 8 including an elemental silicon layer of an optical thickness of about 800 angstroms, followed by a layer of silicon dioxide of an optical thickness of about 1500 angstroms, followed by a second layer of elemental silicon of an optical thickness of about 7200 angstroms;

FIG. 9A is a sectional view of a sixth embodiment of the invention comprising an achromatic, spectrally nonselective, first surface, convex vehicular mirror;

FIG. 9B is a graph of the spectral response for the achromatic mirror of FIG. 9A including a coating of elemental silicon on glass of about 6950 angstroms, a thin film of silicon dioxide of about 1050 angstroms, and a second thin film of elemental silicon of about 1600 angstroms as the outermost layer;

FIG. 10 is a sectional view of a seventh embodiment of a spectrally selective vehicular mirror of the present invention;

FIG. 11 is a sectional view of an eighth embodiment of a spectrally selective vehicular mirror of the present invention;

FIG. 12 is a graph of the spectral response for a spectrally selective mirror similar to that shown in FIG. 10 including a multilayer coating of an optical thickness of about 2160 angstroms silicon dioxide sputter coated atop a layer of silicon of an optical thickness of about 880 angstroms on glass;

FIG. 13 is a graph of the spectral response for a mirror known, commercially available, spectrally selective mirror sold by Donnelly Corporation of Holland, Mich., U.S.A.;

FIG. 14 is a sectional view of a ninth embodiment of a spectrally selective vehicular mirror of the present invention;

FIG. 15 is a graph of the spectral response for the mirror of FIG. 14 including a coating of silicon of about 1200 angstroms optical thickness on glass followed by a layer of silicon nitride having an optical thickness of about 2000 angstroms;

FIG. 16 is a sectional view of a tenth embodiment of a second surface spectrally selective vehicular mirror of the present invention;

FIG. 17 is a graph of the spectral response for the mirror of FIG. 16 including a coating of silicon nitride having an optical thickness of about 2200 angstroms on glass followed by a layer of silicon having an optical thickness of about 1200 angstroms and a layer of silicon nitride having an optical thickness of about 2400 angstroms;

FIG. 18 is a sectional view of an eleventh embodiment of a spectrally selective vehicular mirror of the present invention;

FIG. 19 is a graph of the spectral response of the mirror of FIG. 18 including a single layer of silicon having an optical thickness of about 4800 angstroms on glass;

FIG. 20 is a front view of a combined vehicular mirror including a lower panel comprising the mirror of FIG. 18 and a second, upper panel having a higher luminous reflectance than that of the lower panel;

FIG. 21 is a sectional view of a twelfth embodiment of a first surface spectrally selective vehicular mirror of the present invention; and

FIG. 22 is a graph of the spectral response of the mirror of FIG. 21 including a layer of elemental silicon having an optical thickness of about 6800 angstroms coated on glass, a layer of silicon dioxide in front of the silicon layer and

having an optical thickness of about 1050 angstroms, a second layer of elemental silicon in front of the silicon dioxide and having an optical thickness of about 800 angstroms, and a second layer of silicon dioxide in front of the second silicon layer and having an optical thickness of about 2250 angstroms.

DESCRIPTION OF THE PREFERRED EMBODIMENTS

Referring now to the drawings in greater detail, FIGS. 1 and 2 illustrate a first embodiment 10 of the glare-reducing mirror of the present invention adapted for use as an exterior, rearview vehicular mirror for automobiles, trucks or the like. Mirror 10 includes a glass substrate 12 formed from optically clear, transparent, float glass or, alternately, tinted or light absorbing glass cut to the shape of an exterior rearview mirror, in this case, one adapted for use on the driver's/left side of a vehicle. In addition, optically clear or tinted or light absorbing plastic substrates formed from polycarbonate, acrylic, polystyrene, allyl diglycol carbonate, styrene acrylonitrile, polysulfone and the like may be used in this invention. Preferably, substrate 12 has flat or planar front (or first) and rear (or second) surfaces 14, 16 which are generally parallel to one another and a peripheral edge surface 18, although the invention can be used on glass or other substrates having nonparallel surfaces forming prismatic elements typically used in day/night rearview mirror applications, or on glass surfaces that are nonparallel for other reasons. Alternately, substrate 12 may be bent or curved to a desired radius as described below.

As is shown best in FIG. 2, a thin layer 20 of a partially transparent, high refractive index, elemental semiconductor preferably selected from silicon and germanium is coated to a desired thickness on the front or first surface 14 of glass substrate 12. The thickness of layer 20 has been exaggerated for clarity as are the thicknesses of the other coatings and substrates for all the embodiments herein. The viewing direction for the various mirrors is indicated by the arrow in the figure for each embodiment. On the rear surface 16, a protective coating 22 of light absorbing material is applied over the entire surface to absorb and prevent reflection of light transmitted through the semiconductor layer 20 and substrate 12 and prevent secondary reflections which would detract from the reflective quality of mirror 10.

The elemental semiconductor layer 20 of mirror 10 is preferably a vacuum sputtered coating of silicon having an optical thickness within the range of between about 345 and 2400 angstroms. This corresponds to a coating thickness of between about 85 and 600 angstroms at an index of refraction (n) of 4. Specifically, an optical thickness of between about 400 and 2400 angstroms of silicon elemental semiconductor may be coated onto flat or curved substrate 12. This corresponds to a coating thickness of between about 100 and 600 angstroms at $n=4$. The preferred range of optical thickness of elemental silicon for mirror 10 is between about 800 and 1800 angstroms. An optical thickness of about 960 angstroms is most preferred corresponding to a coating thickness of about 240 angstroms at $n=4$. After washing the substrate by conventionally known, standard glass substrate washing methods, various types of vacuum deposition techniques may be used. Preferably, direct current (DC) magnetron vacuum sputtering from a silicon elemental semiconductor target preferably doped with another element or combined with a metal to improve electrical conductivity is used. For example, a silicon sputtering target doped with 200 parts per million (ppm) phosphorous may be used, as can a sputtering target of silicon

doped with aluminum. The level of 200 ppm phosphorous is near the solubility limit in silicon. Electrical conductivity is generally lower for smaller concentrations of phosphorous. Thus, 200 ppm is preferred as it provides good electrical conductivity for the silicon sputtering target, which is especially useful when DC sputtering. If the aluminum concentration in the sputtering target is kept below about 15%, it has been found that subsequent heating and bending processes do not cause any significant loss of reflectance from the mirror and, in fact, increase the resulting reflectance somewhat. Lower target concentrations of aluminum also result in acceptable performance for silicon elemental semiconductor films. Aluminum concentrations above about 15% in sputtering targets of elemental silicon are acceptable for some applications in the present invention where exposure to temperatures above about 200° C. is not anticipated. However, the resulting reflectance loss with such higher aluminum concentrations makes such concentrations less preferred for most embodiments of this invention. Also, it has been found that films sputtered from phosphorous doped silicon targets are less resistant to salt spray damage during environmental testing. Therefore, elemental silicon coatings from phosphorous doped targets are less preferred for first surface mirror applications but useable for second surface vehicular mirrors as described below where the substrate provides protection for the thin films from the environment. Elemental silicon coatings from sputtering targets doped with aluminum are less susceptible to such salt spray damage.

Moreover, other dopants such as gallium, boron, arsenic and the like can be used as well. Suitable results have also been obtained using plasma sprayed sputtering targets using either a 200 ppm phosphorous-doped silicon composition or a composition of 6% aluminum and 94% silicon of the type manufactured by Plasmaterials, Inc. of San Ramon, Calif. Plasma spraying is a particularly good process for making sputter targets which have geometries nonamenable to conventional sputter target application and can be more economical in that sputtered regions in a used target can be resprayed and filled in instead of replacing the whole target. Suitable results are also obtained using targets formed from a phosphorous doped, crystalline silicon manufactured by Advance International Materials, Inc. of Suffern, N.Y. using a more conventional sputtering target manufacturing process.

It is desirable that any mirror made in accordance with the present invention have achromatic spectral characteristics if it is to be used as a substitute for currently available, commercially acceptable, chromium coated, spectrally non-selective exterior vehicular rearview mirrors. Achromatism is demonstrated by reflectance which remains relatively constant across most of the visible wavelength region of the light spectrum, i.e., between about 400 and 750 nanometers (nm).

With reference to FIG. 3, the spectral response for a specific rearview mirror like that in FIGS. 1 and 2 made by coating elemental silicon semiconductor to an optical thickness of about 1720 angstroms corresponding to a coating thickness of 380 angstroms at $n=4$ onto one glass surface is shown. The coating was made with a vacuum sputtering target of 6% aluminum/94% silicon composition sputtered at a pressure of 3 mTorr in a chamber containing neon gas by DC planar magnetron sputtering. Thereafter, the coated glass was bent using a conventional heating and bending process to a radius of curvature of about 40 inches. Bending is conventionally done by heating the glass to at least 450° C. for a period of time sufficient to permit conforming the glass

to a mold as is known to those skilled in the art of glass bending. Typically, soda-lime glass of a thickness of about 0.093 inches which is preferably used for the embodiments of the present invention described herein is between several minutes and an hour at a temperature of at least 450° C. in an oven or furnace to permit bending. As shown in FIG. 3, the reflectance differs by no more than about 11% across the entire visible wavelength range as measured. In appearance, the mirror is silvery in color, i.e., spectrally nonselective and achromatic. Its luminous reflectance is 63.2% measured from the front or first surface side, and is 57.4% as measured from the rear or second surface side. The luminous transmittance is 24% measured from either side. Of course, thicker or thinner coatings can be made to have lower reflectance which also fulfill the object of the present invention.

The elemental semiconductor mirrors of the present invention are more scratch resistant than conventional first surface mirrors, whether or not the mirror of the present invention is heated. This is shown by rubbing each with fine steel wool. A first surface achromatic mirror of the present invention that was heated and bent to form a convex mirror was rubbed 4000 strokes with fine steel wool and showed no visible damage on close visual inspection. A chromium coated glass first surface mirror subjected to the same test but for only 1000 strokes showed significant damage that was easily visible. This consumer appreciable benefit of enhanced scratch and wear resistance of the present invention also permits using first surface constructions where second surface constructions may have been selected. A further benefit is then realized in that using first surface rearview mirrors avoids a common undesirable trait of second surface mirrors, i.e. double imaging (reflections from both the front glass surface and the rear mirror coated surface simultaneously). Further, first surface use of the elemental semiconductor of this invention, besides enabling enhanced scratch and wear resistance vis-a-vis metal films, as conventionally used, also benefit from consumer desirable wetting characteristics such that rain drops and the like tend to bead on the elemental semiconductor coated surfaces. On a second surface mirror, raindrops tend to wet and spread out over the glass front surface due to surface energy effects and the like. This can lead to blurred image with increased glare, reduced rear vision and increased eye strain therefrom. By contrast, the beading of water droplets upon an elemental semiconductor coated front surface reduces these effects and the water beads tend to run off the coated front surface of the mirror surface by wind action and the like. Thus, these elemental semiconductors are useful as first surface, reduced wetting mirror reflectors of enhanced scratch and wear resistance compared to conventionally known first surface reflectors such as chromium and the like.

Adhesion of a coating to the substrate or of a coating to an already deposited coating can be enhanced if desired by suitable changes to the vacuum parameters. For example, during deposition, the oxygen partial pressure in the coating chamber can be temporarily increased during formation of the first several monolayers adjacent the substrate surface. This assists in improving adhesion. Similarly, the same can be done during formation of other layers as well with similar results.

In mirror 10, and that of FIG. 3, the elemental silicon layer has an index of refraction (n) equal to or greater than 3. In fact, some report refractive indexes for elemental silicon exceeding 4 in the visible spectrum. The use of silicon with such an index of refraction provides an optical thickness, defined as the product of the layer thickness and the refrac-

tive index, which reduces the cost of the present inventive mirror. For example, a thin film having a coating thickness of 1000 angstroms and a refractive index of 3 has an optical thickness of 3 times 1000 angstroms or 3000 angstroms. Thus, with a high index of refraction as with elemental silicon semiconductor, thinner physical layer thicknesses can be used making the mirror less costly to produce.

Optical thickness is an important measurement employed to characterize interference effects which determine the spectral response, i.e., mirror reflectance. Since the present invention uses optical interference, optical thickness is an important consideration in the present mirrors. The optical thickness of a coating can vary across the visible wavelength region of the light spectrum because the refractive index may differ from wavelength to wavelength of light. This phenomenon is known as dispersion. For amorphous elemental silicon in the visible wavelength region, the refractive index varies from $n=4.38$ at a wavelength of 413 nm to $n=3.93$ at a wavelength of 775 nm. Therefore, a typical refractive index of $n=4$ may be assumed to be representative of the refractive index of the deposited elemental silicon in the present invention. The optical thickness based on such a representative index of refraction will be four times the physical thickness. The exact optical thickness depends on the wavelength of light employed for the measurement via the refractive index at that wavelength. Moreover, the refractive indexes listed above are for films deposited under certain conditions. Since the refractive index depends on the deposition conditions, it is preferred to set some limits on the refractive index rather than taking the refractive index to be a specific value for all wavelengths. In general, the refractive index of elemental semiconductors is above $n=3.0$ over the visible wavelength region of the optical spectrum. The present invention utilizes this substantially high refractive index of elemental silicon or germanium thin film without requiring any precise or accurately determined specific values of such refractive index.

FIG. 4 illustrates the effects of optical thickness on the luminous reflectance observed for elemental silicon films on glass, computed using the dispersion of refractive index from which the above refractive indexes were obtained. The bottom axis gives the physical coating thickness and the top axis gives the optical thickness when one assumes that the refractive index is $n=4$ over the region where luminous reflectance is being measured. The oscillations in the curve from 0 to about 2500 angstroms coating thickness, or between 0 and 10,000 angstroms optical thickness, result from optical interference. The high reflectances above 60% occur for coating thicknesses of near 400 angstroms. The interference pattern damps out with greater thickness. This latter effect is due to a dispersive phenomenon called absorption. Whereas dielectric materials typically remain substantially transparent over many thousands of angstroms thickness, and metals typically become opaque or near opaque within about 2000 angstroms optical thickness, elemental silicon goes from highly transmissive at near zero thickness to nearly opaque at about 10,000 angstroms optical thickness. At this point, reflectance becomes constant and does not vary with heavier coating thicknesses. This condition is referred to as near opacity in later embodiments of the present invention.

FIG. 4 also shows that optically opaque or nearly opaque coatings of elemental silicon will have about 40% reflectance, which meets the requirements for luminous reflectance of vehicular rearview mirrors, but will have a grayish cast in reflectance. Thinner layers used in many embodiments of the present invention have a distinctively

silvery appearance. When thicker elemental silicon layers are used for opacification or near opacification in the present invention, the silvery color is maintained by using silicon dioxide or other thin film dielectric materials in conjunction with the thick silicon layer behind the mirror coatings.

Also, applying elemental silicon to coating thicknesses beyond those where oscillations cease as shown in FIG. 4 is not a particular benefit in the present invention. Indeed, the use of thicker than required elemental silicon coatings may potentially increase the likelihood of the film cracking, crazing or otherwise being damaged during heating or bending operations as described hereinafter.

Alternately, the mirror embodiment of FIGS. 1-3 can be produced with an elemental germanium semiconductor layer. Elemental germanium thin films require different thicknesses than those used for elemental silicon layers for equivalent performance because the index of refraction (n) of germanium is higher than that of silicon, i.e., about 5 and ranging from values of about 4.5 to 5.5 in various visible wavelength regions. A value of $n=5$ is used for illustrative purposes herein and to provide a simple conversion between layer thickness and optical thickness. For example, germanium layers would preferably require layer thicknesses within the range of 160 to 500 angstroms to produce an optical thickness of between about 800 and 2500 angstroms which is generally equivalent to that of a silicon layer thickness within the range of about 200 to 600 angstroms producing an optical thickness of between about 800 and 2400 angstroms.

Layers of silicon or germanium differ in their preferred thicknesses for meeting the objects of the present invention as their dispersions of refractive index differ. Achieving a luminous reflectance of about 30% requires an optical thickness of about 345 angstroms of silicon whereas 275 angstroms is sufficient for germanium. Likewise, a luminous reflectance of about 35% requires an optical thickness of about 400 angstroms of silicon whereas 325 angstroms is sufficient for germanium. Similarly, differences in optical thickness between silicon and germanium elemental semiconductor layers are required when other levels of reflectance are desirable. In particular, for germanium elemental semiconductor layers, the corresponding preferred range of optical thickness is from about 275 angstroms to about 2500 angstroms.

Light absorbing coating 22 on the rear surface 16 of mirror 10 may be any dark colored, preferably black, or other light absorbing paint or lacquer applied by spraying, roller coating or curtain coating. Light absorbing coating 22 will have a thickness dependent on the type of coating selected. This thickness will be sufficient to provide an overall luminous transmittance of about 4% or less, and will typically be in the range of 10 microns to 1 mm. For example, a suitable protective paint is METAL SAVERS™ black epoxy coating spray paint #7886, Rust Oleum Corp., Vernon Hills, Ill. When applied to the rear surface of the mirror substrate 12, layer 22 absorbs most or all of the light transmitted through the semiconductor coating 20. Alternately, pigmented adhesive, adhesive tape, UV curable pigmented adhesive having a dark, black or other color followed by a black colored or other highly absorbing tape or other backing such as ceramic may be applied to the rear surface of the mirror to absorb light in the same fashion. Application of a dark colored or black opaque tape or some black or dark colored hot melt plastic or a dark colored, UV, thermally or catalytically cured epoxy material to the rear surface of the invention to a thickness sufficient to keep luminous transmittance of the mirror to less than about 4%

but up to a few millimeters total thickness can provide not only the desired light absorption, but also scatter proofing safety. Tapes, plastic coatings or other adhesive systems hold pieces of the glass mirror substrate together in the event of breakage due to impact or other forces. Such scatter prevention prevents injury to vehicle passengers by preventing the scattering of fragments or shards of glass from the mirror.

It is also possible to incorporate certain dark or black paints which survive high temperatures and yet still function to absorb light transmitted through the reflective elemental semiconductor coating 20. Examples of such paints, which may be applied to the flat glass substrate 12 and subsequently heated and bent along with the semiconductor coating 20 are HIGH TEMP GUARD™ black paint manufactured by Advance Materials of Peachtree City, Ga. and DENPLEX™ #21202 black high temperature paint manufactured by U.S. Packaging Corporation of Wheeling, Ill.

As a further alternative, a slightly modified embodiment 25 of the spectrally nonselective, elemental semiconductor coated, glare-reducing mirror 10 of FIGS. 1-3 may be used as shown in FIG. 5. Mirror 25, where like number numerals indicate like parts to those in mirror 10, includes a substrate 12, elemental silicon or germanium semiconductor coating 20 adjacent the front surface 14, and a light absorbing or anti-scatter coating 22 applied as described above to rear surface 16 of the substrate. In this version, however, a dark or black ceramic thin film 27 is applied first to the front surface 14 of substrate 12 over which the elemental silicon semiconductor layer 20 is thereafter applied in the manner described above. Alternately, ceramic thin film layer 27 may be applied to the rear surface 16 of substrate 12 in place of layer 22 to perform the same light absorbing function. Preferably, layer 27 is a titanium/aluminum/oxi-nitride composite layer which is opaque, highly light absorbing, and black at preferred thicknesses of a few tenths of a micron. It will also be apparent that anti-scatter layer 22 may be coated over ceramic layer 27 when applied to rear surface 16 to provide anti-scatter protection not provided by the ceramic layer. In such case, the optical properties of layer 22 are not important.

Alternately, when elemental silicon semiconductor layer 20 is applied to first surface 14 of substrate 12, light absorbing layer 22 may be omitted if substrate 12 is formed from an opaque ceramic or light absorbing glass material which itself will absorb light and reduce secondary reflections thereby obviating the need for any additional light absorbing layer. For example, a sheet of black ceramic tile may be used as substrate 12 to obtain desired performance characteristics for the mirror shown in FIGS. 1-4.

A second embodiment 30 of the present invention is provided with a coating on the rear or second surface 16' of curved, soda-lime glass substrate 12' is shown in FIG. 6. As illustrated, mirror 30 is bent to a convex form such that the outer glass viewing surface 14' is convex while the rear surface 16' is concave. A layer 32 of elemental silicon is applied to an optical thickness between about 480 and 2400 angstroms, and preferably between about 550 and 1600 angstroms for a luminous reflectance of between 35% and 65%, corresponding to a coating thickness of about between 137 and 400 angstroms at $n=4$, by DC sputtering in neon gas on rear surface 16'. A dark colored backing layer 22 of the type described above is then applied over the silicon coating 32. As described below, especially in connection with mirror 80 in FIG. 16, backing coating 22 may be extended around silicon layer 32 for protection against environmental effects although layer 32 is sufficiently durable even without such

protection. The silicon was sputtered from a 94% silicon/6% aluminum composition sputtering target.

FIG. 7 illustrates the spectral reflectance in the visible wavelength region for mirror 30 with an elemental silicon layer 32 of an optical thickness of about 1600 angstroms and coating 22 as described above. The luminous reflectance after heating and bending, but before applying dark backing coating 22, is 61.5% as measured from the concave side of the mirror, and 55.9% as measured from the convex or viewing side. The luminous transmission through the glass and layer 32 is 24.6%. After coating the rear surface with Rust Oleum METAL SAVER™ black epoxy coating spray paint #7886, the luminous reflectance as measured from the convex side is 47.5%. As shown in FIG. 7, the reflectance varies by no more than about 16% over the visible spectrum making mirror 30 essentially achromatic or spectrally non-selective.

Mirror 30 differs from mirrors 10 and 25 in that the initial reflecting surface is the glass/silicon interface whereas, in mirrors 10 and 25, it is the air/silicon interface that is first encountered. Less light is reflected in mirror 30 prior to encountering the absorbing effect of the silicon layer 32 itself. The higher reflectance from the first encountered surface in mirrors 10 and 25 compared with the first encountered surface in mirror 30 is due to a larger difference in the refractive indexes at the air/silicon interface than at the glass/silicon interface. Also, dark colored backing 22, if used, impacts the optical response of mirror 30 since it directly contacts one surface of the silicon elemental semiconductor layer 32. The optical constants of the paint/lacquer/resinous plastic, epoxy cured plastisol or like backing have some effect on the optical response, i.e., on reflectance as a function of wavelengths and therefore also on the luminous reflectance of the mirror. Yet, it is possible to achieve luminous reflectances between 55% and 60% by proper selection of the thickness of layer 32 of the silicon elemental semiconductor and by care and selection of the paint or other dark backing layer 22.

It is also possible to include a low refractive index dielectric material such as silicon dioxide or silicon nitride coated over silicon layer 32 followed by an opaque thin film or dark backing such as paint, lacquer, epoxy cured plastisol, resinous plastic or the like in order to provide the desired level of reflectance and the desired spectral nonselectivity or spectral selectivity. For example, a second surface achromatic mirror 35 of this construction was made as shown in FIG. 7A by coating a thin layer 36 of elemental silicon semiconductor onto a glass substrate 12' followed by coating a thin layer 38 of silicon dioxide over the silicon, then bending the coated glass, then painting the coated side of the construction as shown at 22 in the manner described above. The elemental silicon semiconductor layer 36 was coated to an optical thickness of about 750 angstroms, and this was followed by coating a thin layer 38 of silicon dioxide to an optical thickness of about 1600 angstroms. The coated glass substrate was then bent so that the thin layers were on the concave surface of the glass substrate. Finally, a black epoxy spray paint coating 22 of Rust Oleum #7886 METAL SAVER was applied to the rear of the silicon dioxide layer. This design yielded a luminous reflectance of about 52%, viewed second surface through the glass substrate. Moreover, the mirror was still silvery or achromatic in appearance.

With reference to FIGS. 8 and 9, an alternate form 40 of the mirror invention is shown wherein secondary reflections are reduced using thin films. Mirror 40 includes highly absorbing thin films which are adjusted and provided in

appropriate thicknesses in place of dark colored backing layers such as that described above at 22 whereby the entire coated substrate essentially is opaque, or near opaque, or low light transmitting in nature, i.e., less than 4% luminous transmission. This alternate form can be included in both first and second surface mirrors of both the achromatic or nonspectrally selective and spectrally selective or blue types of mirrors. If elemental silicon is used as the highly absorbing thin film, then the coating may be heated and bent without sacrificing reflective or other optical qualities as described below. This differs from the use of metals that either will not survive bending or require the use of sacrificial layers to maintain their integrity during high temperature bending processes, or merely to survive heating in an oven. Using elemental or near elemental silicon thus provides significant advantages over use of metals.

The use of thin films for opacifying mirrors of the present invention as described above can be preferred in order to avoid secondary operations of applying absorbing coatings or tapes to the mirror rear surface. For example, painting can overspray or wick onto the mirror front surface, requiring another face scrubbing or cleaning operation to remove the undesirable overspray. Avoiding overspray or wicking requires extra fixturing and/or care. Also, painted parts are more difficult to cut into shapes. We find locating the cutting wheel scribe line more difficult on painted mirrors than on mirrors opacified by the use of thin film means, resulting in yield loss from errors in breaking the cut shape out of the larger glass lite. Therefore, there are certain advantages that come from opacification or near opacification by the use of thin film means. Even more advantage is gained because the entire opacified or near opacified mirror of the present invention is bendable, thus permitting single shape bending after cutting the shape from a flat lite of glass. A further advantage of opacification or near opacification by use of thin film means is that the entire commercially useable mirror comprising the reflective means and the opacification or near opacification means can be fabricated in an integrated process, such as a thin film deposition chamber, without requiring subsequent processing.

As shown in FIG. 8, a specific achromatic, nonspectrally selective mirror design 40 is illustrated including a two layer combination of silicon dioxide or silicon nitride and elemental silicon substituted for the dark colored backing layer. In this case, the first elemental silicon layer on glass is adjusted to produce an achromatic second surface mirror. As shown in FIG. 8, a layer of elemental silicon 42 having an optical thickness of about 800 angstroms, corresponding to a coating thickness of about 200 angstroms at $n=4$, is sputtered as described above onto rear surface 16 of a flat, soda-lime glass substrate 12. Thereafter, a silicon dioxide layer 44 having an optical thickness of about 1500 angstroms, corresponding to a coating thickness of about 1000 angstroms at $n=1.5$, is applied by RF sputtering using a silicon dioxide target in argon sputtering gas at a pressure of 3 mTorr as described above. Subsequently, a thicker layer 45 of elemental silicon is deposited in the same manner as the first elemental silicon layer 42 but having an optical thickness of about 7200 angstroms corresponding to a coating thickness of about 1800 angstroms at $n=4$. In this form, thicker layers 45 of elemental silicon are acceptable. The selection of layer thicknesses to provide opacification is made such that the overall luminous transmittance is below about 10% and preferably below about 4% for any mirror of the present invention. For example, elemental silicon layers 45 of optical thickness greater than about 4000 angstroms or thereabouts achieve overall luminous light transmittance of

about 10% or less. Use of elemental silicon layers 45 of optical thickness greater than about 6800 angstroms will achieve overall luminous light transmittance of about 4% or less. When manufactured with layer 45 being silicon of optical thickness 7200 angstroms, mirror 40 has a luminous reflectance of 61% and a luminous transmittance of 0.1%. When heated to over 500° C., in less than a minute by placing into a furnace, the resulting heated coating maintains a reflectance of at least 61%, is achromatic or spectrally nonselective, and has a luminous transmittance of only 0.8%. This result is illustrated in FIG. 9 wherein the second surface spectral reflectance is shown as a function of wavelength of incident light. Even though mirror 40 has no dark colored or black backing at all, it still is silvery in color when viewed from the front side.

As indicated previously, thin film opacification means can be used for both the first and second surface mirrors of both the achromatic and spectrally selective type. For example, an opacified achromatic first surface mirror can be constructed by using a thin film design comprising an outer reflector layer of silicon elemental semiconductor, of optical thickness 800 angstroms or thereabouts, which is opacified with an underlying additional thin film means consisting of a thin film of silicon dioxide, of optical thickness 428 angstroms or thereabouts, followed by a thin film of silicon elemental semiconductor, of optical thickness of at least 4000 angstroms or thereabouts and preferably of at least 6800 angstroms or thereabouts, all deposited onto the front surface of the glass substrate. The optical design is thus air/silicon (800 angstroms optical thickness)/silicon dioxide (428 angstroms optical thickness)/silicon (6800 angstroms optical thickness)/glass and is similar to that in FIG. 9A. Further, for either first or second surface mirrors, the additional thin film means are disposed to the rear of the elemental semiconductor reflector layer. Such opacified first surface mirrors have commercial advantage in that the reflector layer and additional thin film opacification means are deposited on the same glass surface, thus facilitating coating deposition onto glass substrates being conveyed past a sputtering target, for example, and in that a single type of sputtering target, for example, a silicon target in the designs above, can be used to deposit all the layers in the thin film construction.

Within the context of this invention, full or high reflectivity is a mirror reflectance that approaches as close as is practical the 90% or thereabouts luminous reflectance conventionally provided by second-surface silvered mirrors. Car drivers, particularly in the United States, have for decades opted to use exterior glare-reducing rearview mirrors which use a thin film of chromium metal as their reflector element and thereby achieve a reflectance level (of 55±5% or thereabouts) which is moderate and offers a compromise between daytime visibility and nighttime glare protection. However, truck drivers in general, and some car drivers, particularly in Europe, have continued use of silvered, high reflectance mirrors. They do so because they particularly value the extra rear vision performance of such high reflectance mirrors and are willing to suffer the excessive glare reflected off said high reflectance mirrors. Thus, some drivers desire a high reflectance mirror with at least 60% luminous reflectance desirable, and greater than 70% preferred. To meet these driver's preferences, another embodiment 46 of an opacified achromatic mirror was made as shown in FIG. 9A comprising a first surface mirror having a first layer 47 of elemental silicon coated onto a glass substrate 12 to an optical thickness of about 6950 angstroms, followed by deposition of a thin film 48 of silicon dioxide at

an optical thickness of 1050 angstroms, followed by deposition of a thin film 49 of elemental silicon to an optical thickness of about 1600 angstroms. Mirror 46 had a luminous reflectance of 69% before heating and bending and, as shown in FIG. 9B, a luminous reflectance of 74% after heating and bending. This convex, curved mirror then offers those drivers who desire to use a high reflectance mirror the advantages of scratch and wear resistance offered by the elemental semiconductor mirror.

A seventh embodiment 50 of the mirror incorporating an elemental semiconductor layer is shown in FIG. 10. Mirror 50, where like numerals indicate like parts, is a spectrally selective, glare-reducing mirror in which the spectrally selective color, namely, blue, being reflected is strong and quite noticeable to the viewer. In mirror 50, substrate 12 includes a first layer 52 of elemental silicon semiconductor preferably vacuum sputter coated on first surface 14 to an optical thickness of between about 345 and 2400 angstroms, and preferably between about 720 and 920 angstroms corresponding to a coating thickness of between about 180 and 230 angstroms at $n=4$. If elemental germanium is used, layer 52 will have an optical thickness of at least about 275 angstroms. Applied over the front surface of silicon layer 52 is a relatively thicker, interference layer 54 of a dielectric material, namely, silicon dioxide (also known as silica) having an optical thickness of at least about 500 angstroms, and preferably of between about 1600 and 2800 angstroms, and most preferably of about 2250 angstroms corresponding to a coating thickness of about 1500 angstroms and an index of refraction of about $n=1.5$. Finally, a light absorbing coating 22 is applied as described above to rear surface 16 of the substrate.

Preferably, silicon dioxide coating 54 is applied in a vacuum sputter coating chamber in a manner similar to that for silicon layer 20 as described above for mirror 10. In addition, silicon dioxide layer 54 can be applied in the same vacuum sputter coating chamber as silicon layer 52 if there is sufficient separation of the coating compartments to eliminate any oxygen liberated or employed purposely for the silicon dioxide coating process being involved in the relatively oxygen free environment present in the coating chamber wherein silicon semiconductor deposition occurs. Preferably, silicon dioxide layer 54 is formed by radio frequency (RF) or direct current (DC) reactive sputtering using a silicon elemental semiconductor target within a sputtering chamber including an atmosphere of an inert gas mixture such as neon, argon or the like and oxygen. Alternately, the atmosphere may be pure oxygen. The sputtering in such chamber creates an oxidized layer of the semiconductor target material. Alternately, silicon dioxide may be radio frequency sputtered from a fused quartz or silicon dioxide (SiO_2) target in an atmosphere of argon, neon, oxygen, or mixtures thereof or other gas used as a sputter discharge support gas. RF sputtering is particularly useful if the silicon elemental semiconductor target is not very electrically conductive or if silicon dioxide, which is an electrical insulator, is used. If, however, the silicon elemental semiconductor target is doped with phosphorous as mentioned above, then the conductivity may be sufficient for use of DC sputtering.

Examples of other thin film dielectric materials suitable for our mirror applications are fluorides, of which cryolite and magnesium fluoride are exemplary, other oxides such as silicon monoxide, cerium oxide, tantalum oxide, titanium dioxide, and aluminum oxide, sulfides like zinc sulfide and nitrides such as silicon nitride. Such dielectrics can be deposited by vacuum deposition or other techniques such as

dip coating, to produce thin film layers of refractive index between about 1.3 and 2.7.

As an alternative to the spectrally selective mirror 50 shown in FIG. 10, a similar spectrally selective mirror 60 is shown in FIG. 11 where like parts are indicated by like numerals. Mirror 60 includes a transparent glass substrate 12 having a thin layer of elemental silicon semiconductor 62 on front surface 14. Layer 62 is applied preferably by vacuum sputtering as described above or alternately by other vacuum deposition methods. Next, a silicon dioxide layer 64 is dip-coated or spin coated on at least the coated surface of substrate 12. In some cases, similar thin film layer 66 may be simultaneously dip-coated on rear surface 16. Alternately, rear surface 16 may be covered to prevent coating when dipped. When substrate 12 is soda-lime glass, the silicon dioxide or silica layers 64, 66 have a refractive index close to as that of the glass. Hence, little or no reflection occurs at the silica/glass interface so that dip-coated silicon dioxide layer 66 is coated on rear surface 16 of silicon coated glass with no appreciable effect on the optics. Yet, layer 64 which overcoats the silicon 62 on the front side of the substrate, has an appreciable interference optical effect creating the spectral selectivity desired for the mirror. After the above dip coating of layers 66 and/or 64, a light absorbing layer 22 can be applied to the rearmost surface over dip-coated silica layer 66 or rear surface 16 in the manner described above or, alternately, can be omitted if substrate 12 is an opaque glass or ceramic or other substrate.

The above dip coating method for applying layers 64, 66 of silicon dioxide may be accomplished by the dip and fire technique wherein substrate 12 including coating 62 thereon is dipped into a solution of an appropriate precursor of silicon dioxide dissolved in a suitable solvent. For example, a solution formed by dissolving tetraethylorthosilicate in alcohols can be used. Upon withdrawal from this solution, the solution evenly wets one or both surfaces, i.e., the coated first surface and the uncoated second surface, of the substrate depending on whether the second surface is covered when dipped. The coating on the first and second surfaces is then fired in an oven at about 450° C. for about 60 minutes, or thereabouts, to complete hydrolysis and condensation and to densify the newly formed oxide coating. If curved glass is desired, either the dipped coating or the dip/fire oxide coating can be bent in a conventional bending process. The thicknesses of the dip-coated silicon dioxide films can be adjusted by modifying the withdrawal rate from the oxide precursor solution. The faster the withdrawal rate, the thicker the film on the coated and uncoated substrate sides.

As an example of mirrors 50 and 60 shown in FIGS. 10 and 11, the spectral reflectance for a similar mirror in the visible region is shown in FIG. 12. A 680 angstrom optical thickness layer of elemental silicon semiconductor, corresponding to a coating thickness of about 170 angstroms at $n=4$ was deposited on the front surface of a glass substrate by DC sputtering from a sputtering target comprising a composition of 6% aluminum and 94% silicon using neon sputtering gas at a pressure of 3 mTorr. Thereafter, a 2160 angstrom optical thickness layer of silicon dioxide dielectric corresponding to a coating thickness of about 1440 angstroms at $n=1.5$, was deposited as an interference coating by radio frequency sputtering from a silicon dioxide sputtering target using argon sputtering gas at a pressure of 3 mTorr at an RF power of 2 kW. This coated glass was then bent in a conventional glass bending apparatus by heating to at least 450° C. for between a few minutes and an hour followed by pressing the heated, coated glass in a curved mold. At this point, the luminous transmittance was 38.9% and the lumi-

nous first surface reflectance was 42.7%. The rear or second surface was then coated with a BLACK BASE COAT paint manufactured by Lilly Industrial Coatings of Indianapolis, Ind. The resultant mirror had a luminous reflectance of 42.1% which is only slightly lower than before applying the paint and is suitable for use as an exterior automotive rearview mirror world wide. The thicknesses of both the silicon and silicon dioxide layers provide such reflectance and can be adjusted to change the luminous reflectance. For example, if the optical thickness of silicon elemental semiconductor layer 52 or 62 is decreased to below about 680 angstroms but remains above 345 angstroms, corresponding to a coating thickness of 170 angstroms and 86 angstroms, respectively, at $n=4$, while the silicon dioxide layer remains at an optical thickness of about 2250 angstroms corresponding to a coating thickness of about 1500 angstroms, the luminous reflectance will decrease below 40% as the elemental silicon layer gets thinner.

For comparison purposes, the luminous reflectance of a commercially available spectrally selective blue mirror marketed by Donnelly Corporation of Holland, Mich. under the name "BLUE MIRROR" using a multilayer coating having a nearly opaque metal therein is shown in FIG. 13. The peak reflectance occurs in both mirrors between 400 and 500 nm in the blue range of the visible spectrum and falls off sharply thereafter in the yellow/red portions of the spectrum. As indicated, the response is sufficient for the mirror similar to that of mirrors 50 and 60 to provide acceptable spectral response with an already commercially accepted rearview mirror.

Another rearview mirror 70 incorporating the present invention and comprising a first surface spectrally selective mirror is shown in FIG. 14 where like numerals indicate like parts in mirrors 10, 25, 30, 35, 40, 50 and 60. Mirror 70 includes a transparent or opaque substrate 12, preferably formed from soda-lime glass or ceramic, a thin layer of elemental silicon semiconductor 72 on first or front surface 14, and a second layer 74 of another dielectric material, namely, silicon nitride coated on the front surface of silicon layer 72. A light absorbing layer 22 of the type described above is applied by one of the above-described methods to rear surface 16 to prevent secondary reflections as mentioned above. Silicon layer 72 preferably has an optical thickness of between about 800 to 1200 (coating thickness of 200 to 300 angstroms at $n=4$) angstroms, while silicon nitride layer 74 has a preferred optical thickness of 1600 to 2800 angstroms (coating thickness of 800 to 1300 angstroms at $n=2.0$). Silicon nitride is a useful interference coating to provide the spectral selectivity desired for the mirror since its index of refraction (n) is about 2.0 to 2.2. As with layers 54, 64 in mirrors 50, 60, it is desired that the interference coating have an optical thickness equal to approximately one-quarter of the wavelength of the region of the visible spectrum to be suppressed or spectrally selected in the mirror.

The spectral reflectance of a mirror made in accordance with mirror 70 is shown in FIG. 15 calculated for a soda-lime glass substrate coated with an optical thickness of about 1200 angstroms of silicon elemental semiconductor as layer 72 (coating thickness of about 300 angstroms at $n=4$) followed by layer 74 of silicon nitride having an optical thickness of about 2000 angstroms (coating thickness of about 1000 angstroms at $n=2.0$) and an $n=2.0$ to 2.2 over the silicon layer 72. The luminous reflectance is computed to be 40.3 and, thus, is useful as an exterior rearview mirror in both the United States and Europe. Excellent spectral selectivity is obtained due to the high reflectance in the 400 to 500

nm region or blue wavelength portion of the visible spectrum and the low reflectance in the yellow/red portion of the spectrum above about 560 nm wavelengths.

In FIG. 16, another mirror 80 is shown comprising a spectrally selective blue mirror in which multiple thin coatings are formed on the second surface 16 of the transparent glass substrate 12. Mirror 80 includes a thin layer 82 of silicon nitride coated to an optical thickness of between about 1600 and 2800 angstroms corresponding to a coating thickness between about 800 and 1400 angstroms when $n=2.0$, and preferably an optical thickness of 2200 angstroms on rear surface 16 of substrate 12, followed by layer 84 of elemental silicon semiconductor having an optical thickness between about 275 and 2400 angstroms corresponding to a coating thickness between about 68 and 600 angstroms at $n=4$, and preferably, an optical thickness of between about 500 and 1200 angstroms. This is followed by another layer 86 of silicon nitride coated to an optical thickness of about 2400 angstroms corresponding to a coating thickness of about 1200 angstroms at $n=2.0$. Again, as in previous embodiments, a light absorbing layer 22 is coated over the rear surface of the final silicon nitride layer 86 to reduce secondary reflections and improve mirror performance. Light absorbing layer 22 can be formed from any of the materials or coatings set forth above in connection with mirror 10 or the other embodiments. As shown in FIG. 17, the spectral reflectance for mirror 80 with layers 82, 84, 86 having optical thicknesses of 2200, 1200 and 2400 angstroms, respectively, provides enhanced spectral reflectivity in the blue region of the visible spectrum between 400 and 500 nm while the overall luminous reflectance of the entire mirror is about 38%. Reflectance in the yellow/red wavelength region above about 560 nm is significantly reduced showing the usefulness of mirror 80 as a glare-reducing, spectrally selective, blue mirror.

Although light absorbing coating 22 is shown as being only on the rear surface of thin silicon nitride layer 86, it can be extended around the edges of layer 82, 84 and 86 to overlap the peripheral edge of substrate 12 as shown in the dotted lines of FIG. 16. This helps to protect the edges of the thin layer coatings from elemental conditions such as moisture, humidity, salt spray, car wash detergents, oxidation, abrasion and the like commonly encountered by vehicles. However, it has also been found that the elemental semiconductor layers of silicon or germanium in the present invention have excellent inherent resistance to damage from such environmental effects even without protective overcoatings of this type. Indeed, a coating of silicon or germanium on the first surface of a substrate as described above has significant resistance to environmental damage due to oxidation, salt, heat, humidity, abrasion, detergents and the like. As described below, the scratch resistance and hardness of single semiconductor layers especially of silicon can be improved by heating the coated substrate such as in alehr heating conveyor line.

As shown in FIGS. 18 and 19, the present invention also encompasses spectrally selective rearview mirrors constructed of single layers of an elemental semiconductor preferably coated to an optical thickness of within the range of between about 2400 and 10,000 angstroms depending on whether silicon or germanium is used. For example, as shown in FIG. 18, mirror 90 includes a single layer 92 of elemental silicon semiconductor coated to an optical thickness of about 4800 angstroms corresponding to a coating thickness of about 1200 angstroms at $n=4$ on the first surface 14 of glass substrate 12. In addition, a light absorbing layer 22 such as that described above for the other rearview mirror

embodiments may be coated on rear surface 16 to reduce secondary reflections. Mirror 90, when constructed in this form, provides a spectral reflectance which is visually blue and an overall luminous reflectance of about 31% as shown in FIG. 19. FIG. 19 also illustrates the enhanced reflectance in the blue region of the visible spectrum, namely, in the 400 to 500 nm region.

Although luminous reflectance for mirror 90 shown in FIGS. 18 and 19 is below the 35% required for U.S. and European automotive rearview mirror applications, such mirror may be combined to produce an overall mirror 100 (FIG. 20) including a high luminous reflectivity mirror panel 102 positioned in a suitable frame or case 104 vertically above the reduced luminous reflectivity, glare-reducing mirror panel 90. Mirror 100 will provide extra glare-reducing protection in high glare environments but permit a driver to observe using the higher reflectance mirror 102 when desired. Alternately, such a mirror can be used in countries outside the U.S. or Europe where regulations are different, or in applications where such regulations do not apply.

It is also possible to modify the visual color enhanced in the spectrally selective mirror such as that shown in FIGS. 18 and 19 by varying the thickness of the single layer 92 of mirror 90. For example, by coating layer 92 to an optical thickness of about 9600 angstroms, corresponding to a coating thickness of about 2400 angstroms at $n=4$, a mirror enhancing visibility in the blue-green region of the visible spectrum from about 400 nm to 600 nm is produced.

An alternate embodiment 110 of a first surface, spectrally selective, blue mirror similar to mirror 50 but including additional thin film opacification layers 116, 118 instead of a dark colored backing coating on glass substrate 12 is illustrated in FIG. 21. In mirror 110, two additional thin film layers are added to the front surface of the coated mirror. Thus, as shown in FIG. 21, a layer 112 of elemental silicon of an optical thickness of at least 4000 angstroms, and preferably at an optical thickness of between about 6800 and 10,000 angstroms, corresponding to a coating thickness of between about 1700 and 2500 angstroms at $n=4$, is deposited as in previous embodiments onto glass although other substrate materials could be used. This is followed by a silicon dioxide layer 114 of an optical thickness of about 1050 angstroms, corresponding to a coating thickness of about 700 angstroms at $n=1.5$, on the front surface of layer 112. In turn, layer 114 is followed by deposition of a second elemental silicon layer 116 of an optical thickness of about 800 angstroms, corresponding to a coating thickness of about 200 angstroms at $n=4$, followed by a second and final layer 118 of silicon dioxide having an optical thickness of about 2250 angstroms corresponding to a coating thickness of about 1500 angstroms at $n=1.5$.

The spectral reflectance of mirror 110 on glass with silicon layer 112 at an optical thickness of about 6,800 angstroms and layers 114, 116, 118 as described above is shown in FIG. 22 illustrating spectral selectivity in the blue regions of the visible spectrum and sufficiently high reflectance for use as an automotive rearview mirror. The color of mirror 110 in reflectance is blue and the luminous reflectance is 46.2%. In addition, mirror 110 is nearly opaque with a luminous transmittance of 0.1%. Such a low transmittance obviates the need for a black backing of any sort, such that mirror 110 is compatible with existing first surface rearview mirrors where adhesives are already available for securing the mirror to a mirror casing and assembly which may eventually be installed on a vehicle.

In general, opacification or near opacification using additional thin film means may require adjustment with respect

to other layers of the construction, particularly in second surface constructions. However, by using opacification layers of elemental semiconductors and dielectric materials instead of other backing materials, the major advantage is realized of allowing heating and bending after coating on flat substrates.

As will now be apparent, in all embodiments of the mirrors herein, silicon nitride or other heatable and bendable dielectric materials which do not degrade upon heating may be substituted for silicon dioxide. Moreover, variations of the various optical and coating thicknesses for each of the mirrors can be used while maintaining good results.

As mentioned above, the application of heat to the single elemental semiconductor layers when coated on glass significantly improves the environmental and abrasion resistance for mirrors incorporating such a layer. For example, if first surface mirrors 10, 90 or 110 are desired to have improved scratch and abrasion resistance, it is beneficial to heat the coated substrates to temperatures of at least about 200° C. or so for a short period of time. Heating to such temperature is accomplished satisfactorily by, for example, increasing the temperature to 450° C. in an oven in less than one hour followed by decreasing that temperature in less than two hours to ambient/room temperatures while providing a relatively short soak time at the 450° C. level, i.e., between about 0 and 30 minutes. Lower temperatures could be used but require longer heating periods for equivalent results. After such heating, the elemental semiconductor coating on the substrate is environmentally resilient, hard and scratch resistant and, therefore, highly suitable for automotive rearview mirror use. Such heating can, for example, be conducted through alehr heating conveyor line as is conventionally known.

Alternately, the improved hardness, resiliency and scratch resistance of the elemental semiconductor coating described above can be obtained by heating a sheet of glass to a temperature of about 200° C. prior to coating the glass with the elemental semiconductor. One surface of the heated glass sheet may then be coated with a thin layer of an elemental semiconductor such as silicon or germanium to a desired optical thickness of at least about 800 angstroms which will also cause the semiconductor coating to be environmentally hard, resilient and scratch resistant after the coated heated substrate cools.

Exemplary of the resiliency and scratch resistance of such coatings is a comparison of two otherwise identical elemental silicon thin films coated onto single strength soda-lime glass where one was retained as deposited and the other was conveyed through a lehr furnace having heating stages set for 550° C., 540° C. and 520° C. at a conveyor rate of 61 inches per minute. Both resultant coated glass substrates were abraded with an eraser stroke tester well known in the art. The sample which was heated in the Lehr furnace process showed about the same level of film damage at 3000 strokes of the tester as the unheated sample did at about 1000 strokes. Thus, although heating of the elemental silicon layers need not be done, when heating is employed, either with or without subsequent bending, the resistance to environmental damage is significantly improved making the improved coatings useful for rearview mirrors where high quality and durability standards are common.

Alternately, the production economics of producing the mirrors of the present invention are increased over prior known mirror production methods due to the ability to heat and bend the elemental semiconductor coating on glass without degrading the reflectivity thereof. For example,

when the silicon film of one or more of the above mirror embodiments is coated onto flat glass, the glass may then be heated and bent in a conventional bending process without significant degradation of the silicon film, i.e., without crazing, cracking or hazing, or reduction in reflectance. Such bending is conventionally done by heating the glass up to a temperature of at least 450° C. or thereabouts, following by conforming the glass to a metallic or other mold all as is known to those in the art of glass bending. Alternately, shapes can be cut from large, flat coated glass lites, followed by use of the flat shapes as individual pieces or heating and bending of the individual pieces to form, for example, convex exterior rearview mirrors for automobiles. Alternately, bending can be done on the large, coated glass lites followed by cutting of the mirror shapes. The latter method is especially economical by allowing the vacuum sputter coating of silicon layers on large glass lites followed by heating to improve the resilience and scratch resistance of the layers after which the large glass lite can be either bent or cooled to allow cutting into individual mirror shapes. If the glass lite is bent subsequent to heating, the large bent glass lite can then be cut into individual shapes for use as desired. This method also allows the mass coating of numbers of large glass lites for retention in inventory until needed to produce individual flat mirror shapes or bent mirror shapes in one of the two processes described above.

It is also possible without degrading the reflective character of the mirror to produce curved mirrors by heating and bending after coating of the dielectric interference layers on top of or in combination with the elemental semiconductor layers of silicon or germanium again without cracking, hazing or crazing during such heating and bending. In addition, through the use of high temperature paint such as those mentioned above, the final light absorbing coating used to prevent secondary reflections may also be applied to the glass lites prior to heating and bending again without degradation of the coating during such processing. It has been found that during such heating and bending, the elemental semiconductor coating does not become converted to its oxide such as silicon dioxide where the refractive index would drop significantly as would the mirror reflectance. Rather, high temperature heating followed by bending of such substrates with combined coatings allows the refractive index to remain high in the elemental semiconductor layer such that mirrors of excellent reflective quality are produced all without cracking, crazing or hazing during heating and bending.

In addition, the above method permits in-line, sequential processing wherein sequential processing units are aligned to maximize manufacturing efficiency. For example, large glass sheets can be loaded onto a conveyor and washed in a glass cleaning unit which utilizes detergent-assisted face cleaning, clean deionized water rinsing and drying using air knives. This cleaned glass can be loaded into an in-line sputter coater where a thin elemental semiconductor coating can be applied to glass in one of several parallel or integrated manufacturing lines, i.e., one for flat mirror production, another for curved, coated glass lite production, one for the cutting of shapes followed by bending of individual shapes, and yet another for applying yet another coating to the glass that is on top of the already coated silicon layer such as an interference coating of dielectric material, namely, silicon dioxide or silicon nitride, as described above. Upon exiting the sputter coating chamber, the now elemental semiconductor coated large glass sheets are, alternately, cut into mini-lites or into shapes, are heated and bent before subsequent cutting, are cut into mini-lites before subsequent

heating and bending, are subsequently sputter coated with one or more additional interference layers, or are coated with high temperature resistance or other protective, light absorbing paint. Depending on the type of paint, the shapes may then pass through a final baking station after which they are packed for customer use. The interference coating may also be applied to the opposite side of the substrate during such processing.

Finally, it is noted that for either large or individual sized glass lites coated with elemental semiconductor layers, such mirrors can be heated and bent in the manner described and stock-piled in inventory until needed. Thereafter, the additional dielectric interference layers can be sputter coated over the previously applied semiconductor layers to produce the spectrally selective mirrors described above.

As yet another alternative, it is possible to apply dielectric interference layers such as silicon nitride layer 82 in mirror 80 to a glass substrate or lite followed by heating and bending of that coated substrate with dielectric layer 82 thereon without crazing, cracking or hazing or other degradation of the dielectric layer. Thereafter, a layer of elemental silicon or germanium semiconductor may be sputter coated over top the previously applied dielectric layer as in layer 84 followed by the application of yet another dielectric layer such as layer 86 of silicon nitride where the first layer 62 is also of silicon nitride. Likewise, the additional, thin film opacification layers such as those at 44, 46 in mirror 40 or at 116, 118 in mirror 110 can also be applied before heating and bending without degradation by such further processing. Accordingly, the economic method of coating, heating and bending without degradation of the coating allows many and varied manufacturing processes for maximum efficiency.

While several forms of the invention have been shown and described, other forms will now be apparent to those skilled in the art. Therefore, it will be understood that the embodiments shown in the drawings and described above are merely for illustrative purposes, and are not intended to limit the scope of the invention which is defined by the claims which follow.

The embodiments of the invention in which an exclusive property or privilege is claimed are defined as follows:

1. A high luminous reflectance mirrored substrate for use on a vehicle comprising:

a substrate having a reflector coated upon a surface thereof,

said reflector comprising a first layer of an elemental semiconductor having a refractive index greater than 3.0 and a second layer of an elemental semiconductor having a refractive index greater than 3.0 with a third layer of a dielectric disposed between said first layer and said second layer, said third layer having a refractive index between about 1.3 and 2.7, and

said reflector having a light reflectance of at least about 60% of light incident thereon at the wavelength region of about 550 nanometers and being achromatic.

2. The mirrored substrate of claim 1 wherein said dielectric comprises one of an oxide, fluoride, nitride, and sulfide.

3. The mirrored substrate of claim 1 wherein said dielectric comprises a compound of at least one of silicon, magnesium, germanium, cerium, tantalum, titanium, zinc, and aluminum.

4. The mirrored substrate of claim 3 wherein said compound comprises one of silicon dioxide, silicon monoxide, germanium oxide, silicon nitride, germanium nitride, cryolite, magnesium fluoride, cerium oxide, tantalum oxide, titanium oxide, aluminum oxide, zinc sulfide, and their combination.

5. The mirrored substrate of claim 1 wherein said dielectric comprises a silicon compound.

6. The mirrored substrate of claim 5 wherein said silicon compound comprises silicon nitride.

7. The mirrored substrate of claim 5 wherein said silicon compound comprises silicon oxide.

8. The mirrored substrate of claim 5 wherein at least one of said first layer and said second layer of elemental semiconductor comprises elemental silicon.

9. The mirrored substrate of claim 1 wherein at least one of said first layer and said second layer of elemental semiconductor comprises elemental silicon.

10. The mirrored substrate of claim 9 wherein said layer of elemental silicon comprises doped silicon.

11. The mirrored substrate of claim 10 wherein said doped silicon is doped with a material selected from the group consisting of phosphorous, aluminum, gallium, boron, and arsenic.

12. The mirrored substrate of claim 1 wherein said substrate is a glass substrate.

13. The mirrored substrate of claim 12 wherein at least one of said first layer, said second layer, and said third layer is a non-vacuum coated layer.

14. The mirrored substrate of claim 13 wherein said non-vacuum coated layer is one of a dip-coated layer and a spin-coated layer.

15. The mirrored substrate of claim 1 wherein said substrate is a bent substrate having a curvature.

16. The mirrored substrate of claim 15 wherein said bent substrate has a generally convex surface and a generally concave surface.

17. The mirrored substrate of claim 16 wherein said reflector is coated on said convex surface.

18. The mirrored substrate of claim 16 wherein said reflector is coated on said concave surface.

19. The mirrored substrate of claim 15 wherein said bent substrate has a radius of curvature of at least about forty (40) inches.

20. The mirrored substrate of claim 15 wherein said bent substrate is formed from glass, said glass being heated to at least about 450° C. following coating of said reflector and bent to said curvature after heating.

21. The mirrored substrate of claim 1 wherein said substrate is heated and bent following coating of said reflector on a surface thereof.

22. The mirrored substrate of claim 1 wherein said mirrored substrate has a luminous transmission of about 10% or less.

23. The mirrored substrate of claim 22 wherein said mirrored substrate has a luminous transmission of about 4% or less.

24. The mirrored substrate of claim 1 wherein said mirrored substrate is a reflector suitable for use in a rearview mirror for a vehicle.

25. The mirrored substrate of claim 24 wherein said mirrored substrate is a reflector of an exterior rearview mirror on a vehicle.

26. The mirrored substrate of claim 26 wherein the vehicle is an automobile.

27. The mirrored substrate of claim 25 wherein the vehicle is a truck.

28. The mirrored substrate of claim 1 wherein said mirrored substrate is a rearview mirror and forms a part of a system comprising at least one other rearview mirror having a luminous reflectance of at least about 30% of the light incident thereon.

29. The mirrored substrate of claim 1 wherein said mirrored substrate is heated to a temperature of at least about

200° C. at one of prior to, during and subsequent to deposition of at least one of said first, second and third layers.

30. A high luminous reflectance mirrored substrate for use on a vehicle comprising:

a glass substrate having a reflector coated upon a surface thereof;

said reflector comprising a first layer of elemental silicon and a second layer of elemental silicon with a third layer of a dielectric disposed between said first layer and said second layer, said third layer having a refractive index between about 1.3 and 2.7; and

said reflector having a light reflectance of at least about 60% of light incident thereon at the wavelength region of about 550 nanometers and being achromatic.

31. The mirrored substrate of claim 30 wherein said dielectric comprises one of an oxide, fluoride, nitride, and sulfide.

32. The mirrored substrate of claim 30 wherein said dielectric comprises a silicon compound.

33. The mirrored substrate of claim 32 wherein said silicon compound comprises silicon nitride.

34. The mirrored substrate of claim 32 wherein said silicon compound comprises silicon oxide.

35. The mirrored substrate of claim 30 wherein at least one of said first layer and said second layer comprises doped silicon.

36. The mirrored substrate of claim 35 wherein said doped silicon is doped with a material selected from the group consisting of phosphorous, aluminum, gallium, boron, and arsenic.

37. The mirrored substrate of claim 30 wherein at least one of said first layer, said second layer, and said third layer is a non-vacuum coated layer.

38. The mirrored substrate of claim 37 wherein said non-vacuum coated layer is one of a dip-coated layer and a spin-coated layer.

39. The mirrored substrate of claim 30 wherein said glass substrate is a bent glass substrate having a curvature.

40. The mirrored substrate of claim 39 wherein said bent glass substrate has a generally convex surface and a generally concave surface.

41. The mirrored substrate of claim 40 wherein said reflector is coated on said convex surface.

42. The mirrored substrate of claim 40 wherein said reflector is coated on said concave surface.

43. The mirrored substrate of claim 39 wherein said bent glass substrate has a radius of curvature of at least about forty (40) inches.

44. The mirrored substrate of claim 39 wherein said bent glass substrate is heated to at least about 450° C. following coating of said reflector and bent to said curvature after heating.

45. The mirrored substrate of claim 30 wherein said glass substrate is heated and bent following coating of said reflector on a surface thereof.

46. The mirrored substrate of claim 30 wherein said mirrored substrate has a luminous transmission of about 10% or less.

47. The mirrored substrate of claim 46 wherein said mirrored substrate has a luminous transmission of about 4% or less.

48. The mirrored substrate of claim 30 wherein said mirrored substrate is a reflector suitable for use in a rearview mirror for a vehicle.

49. The mirrored substrate of claim 48 wherein said mirrored substrate is a reflector of an exterior rearview mirror on a vehicle.

50. The mirrored substrate of claim 49 wherein the vehicle is an automobile.

51. The mirrored substrate of claim 49 wherein the vehicle is a truck.

52. A high luminous reflectance mirrored substrate for use on a vehicle comprising:

a glass substrate having a reflector coated upon a surface thereof;

said reflector comprising a first layer of elemental silicon and a second layer of elemental silicon with a third layer of a silicon compound disposed between said first layer and said second layer, said third layer having a refractive index between about 1.3 and 2.7; and

said reflector having a light reflectance of at least about 60% of light incident thereon at the wavelength region of about 550 nanometers and being achromatic.

53. The mirrored substrate of claim 52 wherein said silicon compound comprises one of an oxide and a nitride.

54. The mirrored substrate of claim 52 wherein said silicon compound comprises silicon nitride.

55. The mirrored substrate of claim 52 wherein said silicon compound comprises silicon oxide.

56. The mirrored substrate of claim 52 wherein at least one of said first layer and said second layer of elemental silicon comprises doped silicon.

57. The mirrored substrate of claim 56 wherein said doped silicon is doped with a material selected from the group consisting of phosphorous, aluminum, gallium, boron, and arsenic.

58. The mirrored substrate of claim 52 wherein at least one of said first layer, said second layer, and said third layer is a non-vacuum coated layer.

59. The mirrored substrate of claim 58 wherein said non-vacuum coated layer is one of a dip-coated layer and a spin-coated layer.

60. The mirrored substrate of claim 52 wherein said glass substrate is heated and bent following coating of said reflector on a surface thereof.

61. The mirrored substrate of claim 62 wherein said mirrored substrate has a luminous transmission of about 10% or less.

62. The mirrored substrate of claim 61 wherein said mirrored substrate has a luminous transmission of about 4% or less.

63. The mirrored substrate of claim 52 wherein said mirrored substrate is a reflector suitable for use in a rearview mirror for a vehicle.

64. The mirrored substrate of claim 63 wherein said mirrored substrate is a reflector of an exterior rearview mirror on a vehicle.

65. The mirrored substrate of claim 64 wherein the vehicle is an automobile.

66. The mirrored substrate of claim 64 wherein the vehicle is a truck.

67. The mirrored substrate of claim 52 wherein said mirrored substrate is a rearview mirror and forms a part of a system comprising at least one other rearview mirror having a luminous reflectance of at least about 30% of the light incident thereon.

68. The mirrored substrate of claim 52 wherein said mirrored substrate is heated to a temperature of at least about 200° C. at one of prior to, during and subsequent to deposition of at least one of said first, second and third layers.

69. The mirrored substrate of claim 52 wherein said glass substrate is a bent glass substrate having a curvature.

70. The mirrored substrate of claim 69 wherein said bent glass substrate has a generally convex surface and a generally concave surface.

71. The mirrored substrate of claim 70 wherein said reflector is coated on said convex surface.

72. The mirrored substrate of claim 70 wherein said reflector is coated on said concave surface.

73. The mirrored substrate of claim 69 wherein said bent glass substrate has a radius of curvature of at least about forty (40) inches.

74. The mirrored substrate of claim 69 wherein said bent glass substrate is heated to at least about 450° C. following coating of said reflector and bent to said curvature after heating.

75. A high luminous reflectance mirrored substrate comprising:

a glass substrate;

a reflector coated upon a surface thereof;

said reflector comprising a first layer of elemental silicon and a second layer of elemental silicon with a third layer of dielectric disposed between said first layer and said second layer, said third layer having a refractive index between about 1.3 and 2.7; and

said reflector having a light reflectance of at least about 60% of light incident thereon at the wavelength region of about 550 nanometers and being achromatic.

76. The mirrored substrate of claim 75 wherein said glass substrate is heated to a temperature of at least 200° C. at one of prior to, during and subsequent to deposition of at least one of said first, second and third layers.

77. The mirrored substrate of claim 76 wherein at least one of said first layer, said second layer and said third layer is a non-vacuum coated layer.

78. The mirrored substrate of claim 77 wherein said non-vacuum coated layer is one of a dip-coated layer and a spin-coated layer.

79. The mirrored substrate of claim 75 including a protective coating applied on at least one of a surface of said glass substrate and a layer of said reflector for absorbing light transmitted by said reflector coated substrate.

80. The mirrored substrate of claim 79 wherein said protective coating comprises one of a paint, a lacquer, a tape, a ceramic, a hot melt plastic, a resinous plastic, a plastisol or an epoxy material.

81. The mirrored substrate of claim 80 wherein said protective coating provides antiscatter protection for said glass substrate should it be broken.

82. The mirrored substrate of claim 80 wherein the luminous transmittance of said protective coated mirrored substrate is less than about 4%.

83. The mirrored substrate of claim 82 wherein said protective coating comprises one of a paint and a lacquer.

84. The mirrored substrate of claim 82 wherein said protective coating comprises a tape.

85. The mirrored substrate of claim 82 wherein said protective coating has a thickness of at least about 10 microns.

86. The mirrored substrate of claim 85 wherein said protective coating has a thickness in the range from about 10 microns to about 1 mm.

87. The mirrored substrate of claim 80 wherein said protective coating is dark colored.

88. The mirrored substrate of claim 79 wherein said protective coating has a thickness of at least about 10 microns.

89. The mirrored substrate of claim 88 wherein said protective coating has a thickness in the range from about 10 microns to about 1 mm.

90. The mirrored substrate of claim 79 wherein the luminous transmittance of said protective coated mirrored substrate is less than about 4%.

91. The mirrored substrate of claim 90 wherein said protective coating is dark colored.

92. The mirrored substrate of claim 91 wherein said protective coating comprises one of a paint and a lacquer.

93. The mirrored substrate of claim 91 wherein said protective coating comprises a tape.

94. The mirrored substrate of claim 79 wherein said protective coating is dark colored.

95. The mirrored substrate of claim 94 wherein said protective coating comprises one of a paint and a lacquer.

96. The mirrored substrate of claim 94 wherein said protective coating comprises a tape.

97. The mirrored substrate of claim 75 wherein said third layer comprises a silicon compound.

98. The mirrored substrate of claim 97 wherein said silicon compound comprises one of an oxide and a nitride.

99. The mirrored substrate of claim 97 wherein said silicon compound comprises silicon nitride.

100. The mirrored substrate of claim 97 wherein said silicon compound comprises silicon oxide.

101. The mirrored substrate of claim 75 wherein said third layer is selected from the group consisting of an oxide, a sulfide, a fluoride and a nitride.

102. The mirrored substrate of claim 30 wherein said mirrored substrate is a rearview mirror and forms a part of a system comprising at least one other rearview mirror having a luminous reflectance of at least about 30% of the light incident thereon.

103. The mirrored substrate of claim 30 wherein said mirrored substrate is heated to a temperature of at least about 200° C. at one of prior to, during and subsequent to deposition of at least one of said first, second and third layers.

* * * * *



US005910854A

United States Patent [19]

Varaprasad et al.

[11] Patent Number: **5,910,854**

[45] Date of Patent: **Jun. 8, 1999**

[54] **ELECTROCHROMIC POLYMERIC SOLID FILMS, MANUFACTURING ELECTROCHROMIC DEVICES USING SUCH SOLID FILMS, AND PROCESSES FOR MAKING SUCH SOLID FILMS AND DEVICES**

[75] Inventors: **Desaraju V. Varaprasad; Mingtang Zhao, both of Holland; Craig Allen Dornan, Grand Haven, all of Mich.; Anoop Agrawal; Pierre-Marc Allemand, both of Tucson, Ariz.; Niall R. Lynam, Holland, Mich.**

[73] Assignee: **Donnelly Corporation, Holland, Mich.**

[21] Appl. No.: **08/824,501**

[22] Filed: **Mar. 26, 1997**

Related U.S. Application Data

[63] Continuation-in-part of application No. 08/406,663, Mar. 20, 1995, abandoned, which is a continuation of application No. 08/193,557, Feb. 8, 1994, abandoned, which is a continuation-in-part of application No. 08/023,675, Feb. 26, 1993, abandoned.

[51] Int. Cl.⁶ **G02F 1/153**

[52] U.S. Cl. **359/273**

[58] Field of Search **359/273, 275**

[56] References Cited

U.S. PATENT DOCUMENTS

Re. 30,835	12/1981	Giglia	350/357
3,215,038	11/1965	Heller et al.	88/61
3,280,701	10/1966	Donnelly et al.	88/77
3,451,741	6/1969	Mannos	350/160
3,453,038	7/1969	Kissa et al.	350/160
3,521,941	7/1970	Deb et al.	350/160
3,652,149	3/1972	Rogers	350/160
3,692,388	9/1972	Hall, Jr. et al.	350/312
3,774,988	11/1973	Rogers	350/150
3,806,229	4/1974	Schoot et al.	350/160
3,807,832	4/1974	Castellion	350/160

(List continued on next page.)

FOREIGN PATENT DOCUMENTS

A6804290 2/1991 Australia C07D 489/04
0115394 8/1984 European Pat. Off. A61K 31/54

(List continued on next page.)

OTHER PUBLICATIONS

H. Akahoshi et al., "Electrochemical and Spectrochemical Properties of Polyviologen Complex Modified Electrodes", *J. Phys. Chem.*, 85, 818-22 (1981).

F.G.K. Baucke, "Electrochromic Mirrors with Variable Reflectance", *Optical Mat'ls Tech. for Energy Efficiency and Solar Energy Conversion V*, SPIE—The International Society for Optical Engineering, SPIE vol. 653, 47-54 (1986).

(List continued on next page.)

Primary Examiner—Georgia Epps
Assistant Examiner—Dawn-Marie Bey
Attorney, Agent, or Firm—Fitzpatrick Cella Harper & Scinto

[57] ABSTRACT

The present invention relates to electrochromic polymeric solid films, manufacturing electrochromic devices using such solid films and processes for making such solid films and devices. The electrochromic polymeric solid films of the present invention exhibit beneficial properties and characteristics, especially when compared to known electrochromic media. The electrochromic polymeric solid films are transformed in situ from a low viscosity electrochromic monomer composition by exposure to electromagnetic radiation, and in so doing minimum shrinkage occurs. The electrochromic polymeric solid films of the present invention also perform well under prolonged coloration, outdoor weathering and all-climate exposure, and provide an inherent safety aspect not known to electrochromic media heretofore.

27 Claims, 1 Drawing Sheet

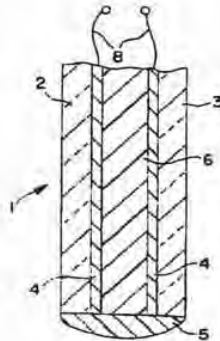

U.S. PATENT DOCUMENTS

3,854,794	12/1974	Van Dam et al.	350/160
3,873,185	3/1975	Rogers	350/147
4,116,545	9/1978	Reddy	350/357
4,139,234	2/1979	Morgan	296/84
4,142,783	3/1979	Engler et al.	350/357
4,174,152	11/1979	Giglia et al.	350/357
4,282,272	8/1981	Matsuihiro et al.	427/126.3
4,304,465	12/1981	Diaz	350/357
4,306,774	12/1981	Nicholson	350/357
4,338,000	7/1982	Kamimori et al.	350/357
4,435,048	3/1984	Kamimori et al.	350/357
4,449,786	5/1984	McCord	350/293
4,465,339	8/1984	Baucke et al.	350/357
4,473,695	9/1984	Wrighton et al.	456/266
4,519,930	5/1985	Kakiuchi	252/62.2
4,550,982	11/1985	Hirai	350/357
4,561,625	12/1985	Weaver	249/85
4,586,792	5/1986	Yang et al.	350/357
4,613,211	9/1986	Papir et al.	350/357
4,652,090	3/1987	Uchikawa et al.	350/357
4,671,619	6/1987	Kamimori et al.	350/357
4,702,566	10/1987	Tukude et al.	350/357
4,712,879	12/1987	Lynam et al.	350/357
4,741,603	5/1988	Miyagi et al.	350/357
4,750,817	6/1988	Sammells	350/357
4,795,242	1/1989	Wudt et al.	350/357
4,807,977	2/1989	Sammells	350/257
4,810,067	3/1989	Demiryont	350/357
4,832,467	5/1989	Miyagi et al.	350/357
4,871,236	10/1989	Gemma et al.	350/357
4,872,745	10/1989	Fujisawa et al.	350/357
4,893,908	1/1990	Wolf et al.	350/357
4,902,108	2/1990	Byker	350/357
4,908,283	3/1990	Takahashi et al.	429/192
4,927,246	5/1990	Ito et al.	350/357
4,962,158	10/1990	Kobayashi et al.	525/279
4,973,844	11/1990	O'Farrell et al.	250/341
4,993,810	2/1991	Demiryont	350/357
5,028,124	7/1991	Akhtar	350/357
5,042,923	8/1991	Wolf et al.	359/275
5,066,112	11/1991	Lynam et al.	359/267
5,068,062	11/1991	Inata et al.	252/518
5,073,012	12/1991	Lynam	359/265
5,076,674	12/1991	Lynam	359/274
5,080,471	1/1992	Cogan et al.	359/275
5,115,346	5/1992	Lynam	359/604
5,122,896	6/1992	Mizusaki et al.	359/273
5,128,799	7/1992	Byker	359/265
5,140,455	8/1992	Varaprasad et al.	359/275
5,142,407	8/1992	Varaprasad et al.	359/276
5,148,014	9/1992	Lynam et al.	250/214
5,148,305	9/1992	Byker	359/265
5,151,816	9/1992	Varaprasad et al.	359/275
5,202,787	4/1993	Byker et al.	359/267
5,207,492	5/1993	Roberts	362/30
5,233,461	8/1993	Dornan et al.	359/272
5,239,405	8/1993	Varaprasad et al.	359/272
5,239,406	8/1993	Lynam et al.	359/275
5,278,693	1/1994	Theiste et al.	359/272
5,280,380	1/1994	Byker	359/265
5,282,077	1/1994	Byker	359/272
5,457,218	10/1995	Cronin et al.	556/44
5,500,760	3/1996	Varaprasad et al.	359/272
5,572,354	11/1996	Desmond et al.	359/265
5,576,687	11/1996	Blank et al.	340/438
5,679,283	10/1997	Tonar et al.	359/273

FOREIGN PATENT DOCUMENTS

0145337	6/1985	European Pat. Off.	G02F 1/17
0240226	10/1987	European Pat. Off.	G02F 1/17

52-10745	1/1977	Japan	G02F 1/17
57-208530	12/1982	Japan	G02F 1/17
59-116623	7/1984	Japan	G02F 1/17
63-262624	4/1987	Japan	G02F 1/17
1-33535	2/1989	Japan	G02F 1/17
1230608	9/1989	Japan	C08F 246/00
WO 94/19212	9/1994	WIPO	
WO 94/27262	11/1994	WIPO	

OTHER PUBLICATIONS

I.F. Chang, "Electrochromic and Electrochemichromic Materials and Phenomena" in *Nonemissive Electrooptic Displays*, 155-96, A.R. Kmetz and F.K. von Willisen, eds., Plenum Press, New York (1976).

E.M. Engler et al., "Electrochromic Display Device With Memory Based On Homogenous Donor Polymer Film", *IBM Tech. Disc. Bull.*, 22(7), 2993-97 (1979).

Y. Hirai and C. Tani, "Electrochromism for Organic Materials in Polymeric All Solid-State Systems", *Appl. Phys. Lett.*, 43(7), 704-05 (1983).

K. Honda and A. Kuwano, "Solid-State Electrochromic Device Using Polynuclear Metal Complex-Containing Solid Polymer Electrolyte", *J. Electrochem. Soc.—Accelerated Brief Comm.*, 853-54 (1986).

K. Itaya et al., "Polymer-Modified Electrodes II. Spectroelectrochemical Properties of a Ligand (Bathophenanthroline Disulfonic Acid) Bound to Polyelectrolytes on Electrodes and the Use of the Modified Electrodes for an Electrochromic Display Device", *J. Electrochem. Soc.*, 129(4), 762-67 (1982).

F.B. Kaufman, "New Organic Materials for Use as Transducers in Electrochromic Display Devices", *Conf. Rec. of 1978 Biennial Display Res. Conf.*, 23, Soc. for Info. Displays (Oct. 24-26, 1978).

F.B. Kaufman et al., "Polymer-Modified Electrodes: A New Class of Electrochromic Materials", *Appl. Phys. Lett.*, 36(6), 422-25 (1980).

S. Kuwabata et al., "Photoelectrochromic Properties of Methylene Blue in Conducting Polyaniline Matrixes", *J. Electrochem. Soc.*, 139(7), 1824-30 (1992).

C.M. Lampert, "Electrochromic Materials and Devices For Energy Efficient Windows", *Solar Energy Materials*, 11, 1-27 (1984).

N. Leventis and Y. C. Chung, "Polyaniline-Prussian Blue Novel Composite Material for Electrochromic Applications", *J. Electrochem. Soc.*, 137(10), 3321-322 (1990).

N. Leventis and Y.C. Chung, "Poly(3-methylthiophene-Prussian Blue: A New Composite Electrochromic Material", *J. Mater. Chem.*, 2(3), 289-93 (1992).

N. R. Lynam, "Electrochromic Automotive Day/Night Mirrors", *SAE Technical Paper Series*, 870636, Society for Automotive Engineers (1987).

N.R. Lynam, "Smart Windows for Automobiles", *SAE Technical Paper Series*, 900419, Society for Automotive Engineers (1990).

N.R. Lynam, "Transparent Electronic Conductors" in *Proc. Symp. on Electrochromic Mat's*, 90-2, 201-31, The Electrochemical Society, Inc., Pennington, New Jersey (1990).

- N.R. Lynam and A. Agrawal, "Automotive Applications of Chromogenic Materials", *Large-Area Chromogenics: Materials and Devices for Transmittance Control*, SPIE Institute Series, IS 4, 46-84, C.M. Lampert and C.G. Granquist, eds., SPIE Optical Engineering Press, Washington (1990).
- Modern Plastics Encyclopedia 1988*, 203-300, McGraw-Hill Inc., New York (1988).
- T. Niwa et al., "All-Solid Large Area Variable Reflectance EC Mirror with a Compound Film of Iridium Oxide and Tin Oxide", *Proc. of 6th Int'l. Disp. Res. Conf.*, P2.19, 322-75 (1986).
- H. Tsutsumi et al., "Polymer Gel Films with Simple Organic Electrochromics for Single-Film Electrochromic Devices", *J. Polym. Sci.*, 30, 1725-29 (1992).
- H. Tsutsumi et al. "Single Polymer Gel Film Electrochromic Device", *Electrochimica Acta*, 37, 369-70 (1992).
- M. Watanabe et al., "High Lithium Conductivity of Polymeric Solid Electrolytes", *Makromol. Chem. Rapid Comm.*, 2, 741-44 (1981).

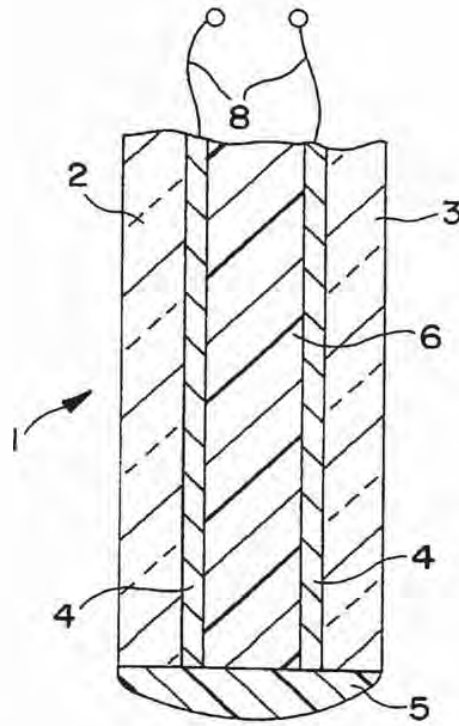

FIG. 1

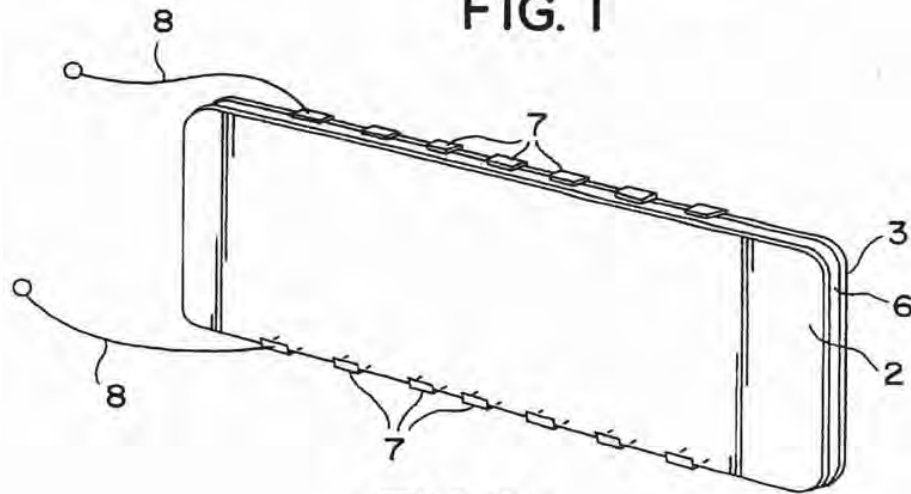

FIG. 2

**ELECTROCHROMIC POLYMERIC SOLID
FILMS, MANUFACTURING
ELECTROCHROMIC DEVICES USING SUCH
SOLID FILMS, AND PROCESSES FOR
MAKING SUCH SOLID FILMS AND
DEVICES**

**RELATED UNITED STATES PATENT
APPLICATIONS**

This application is a continuation-in-part of U.S. patent application Ser. No. 08/406,663, filed Mar. 20, 1995, which is a continuation of U.S. patent application Ser. No. 08/193,557, filed Feb. 8, 1994, (now abandoned), which is a continuation-in-part of U.S. patent application Ser. No. 08/023,675, filed Feb. 26, 1993, (now abandoned).

BACKGROUND OF THE INVENTION

1. Technical Field of the Invention

The present invention relates to reversibly variable electrochromic devices for varying the transmittance to light, such as electrochromic rearview mirrors, windows and sun roofs for motor vehicles, reversibly variable electrochromic elements therefor and processes for making such devices and elements.

2. Brief Description of the Related Technology

Reversibly variable electrochromic devices are known in the art. In such devices, the intensity of light (e.g., visible, infrared, ultraviolet or other distinct or overlapping electromagnetic radiation) is modulated by passing the light through an electrochromic medium. The electrochromic medium is disposed between two conductive electrodes, at least one of which is typically transparent, which causes the medium to undergo reversible electrochemical reactions when potential differences are applied across the two electrodes. Some examples of these prior art devices are described in U.S. Pat. Nos. 3,280,701 (Donnelly); 3,451,741 (Manos); 3,806,229 (Schoot); 4,712,879 (Lynam) ("Lynam I"); 4,902,108 (Byker) ("Byker I"); and I. F. Chang, "Electrochromic and Electrochemichromic Materials and Phenomena", in *Nonemissive Electrooptic Displays*, 155-96, A. R. Kmetz and F. K. von Willisen, eds., Plenum Press, New York (1976).

Reversibly variable electrochromic media include those wherein the electrochemical reaction takes place in a solid film or occurs entirely in a liquid solution. See e.g., Chang.

Numerous devices using an electrochromic medium, wherein the electrochemical reaction takes place entirely in a solution, are known in the art. Some examples are described in U.S. Pat. Nos. 3,453,038 (Kissa); 5,128,799 (Byker) ("Byker II"); Donnelly; Manos; Schoot; Byker I; and commonly assigned U.S. Pat. Nos. 5,073,012 (Lynam) ("Lynam II"); 5,115,346 (Lynam) ("Lynam III"); 5,140,455 (Varaprasad) ("Varaprasad I"); 5,142,407 (Varaprasad) ("Varaprasad II"); 5,151,816 (Varaprasad) ("Varaprasad III") and 5,239,405 (Varaprasad) ("Varaprasad IV"); and commonly assigned co-pending U.S. patent application Ser. No. 07/935,784 (filed Aug. 27, 1992). Typically, these electrochromic devices, sometimes referred to as electrochemichromic devices, are single-compartment, self-erasing, solution-phase electrochromic devices. See e.g., Manos, Byker I and Byker II.

In single-compartment, self-erasing, solution-phase electrochromic devices, the intensity of the electromagnetic radiation is modulated by passing through a solution held in a compartment. The solution often includes a solvent, at

least one anodic compound and at least one cathodic compound. During operation of such devices, the solution is fluid, although it may be gelled or made highly viscous with a thickening agent, and the solution components, including the anodic compounds and cathodic compounds, do not precipitate. See e.g., Byker I and Byker II.

Certain of these electrochemichromic devices have presented drawbacks. First, a susceptibility exists for distinct bands of color to form adjacent the bus bars after having retained a colored state over a prolonged period of time. This undesirable event is known as segregation. Second, processing and manufacturing limitations are presented with electrochemichromic devices containing electrochemichromic solutions. For instance, in the case of electrochemichromic devices which contain an electrochemichromic solution within a compartment or cavity thereof, the size and shape of the electrochemichromic device is limited by the bulges and non-uniformities which often form in such large area electrochemichromic devices because of the hydrostatic nature of the liquid solution. Third, from a safety standpoint, in the event an electrochemichromic device should break or become damaged through fracture or rupture, it is important for the device to maintain its integrity so that, if the substrates of the device are shattered, an electrochemichromic solution does not escape therefrom and that shards of glass and the like are retained and do not scatter about. In the known electrochromic devices, measures to reduce breakage or broken glass scattering include the use of tempered glass and/or a laminate assembly comprising at least two panels affixed to one another by an adhesive. Such measures control the scattering of glass shards in the event of breakage or damage due, for instance, to the impact caused by an accident.

Numerous devices using an electrochromic medium, wherein the electrochemical reaction takes place in a solid layer, are known in the art. Typically, these devices employ electrochromic solid-state thin film technology [see e.g., N. R. Lynam, "Electrochromic Automotive Day/Night Mirrors", *SAE Technical Paper Series*, 870636 (1987); N. R. Lynam, "Smart Windows for Automobiles", *SAE Technical Paper Series*, 900419 (1990); N. R. Lynam and A. Agrawal, "Automotive Applications of Chromogenic Materials", *Large Area Chromogenics: Materials & Devices for Transmittance Control*, C. M. Lampert and C. G. Granquist, eds., Optical Eng'g Press, Washington (1990); C. M. Lampert, "Electrochromic Devices and Devices for Energy Efficient Windows", *Solar Energy Materials*, 11, 1-27 (1984); U.S. Pat. Nos. 3,521,941 (Deb); 4,174,152 (Giglia); Re. 30,835 (Giglia); 4,338,000 (Kamimori); 4,652,090 (Uchikawa); 4,671,619 (Kamimori); Lynam I; and commonly assigned U.S. Pat. No. 5,066,112 (Lynam) ("Lynam IV") and 5,076,674 (Lynam) ("Lynam V").

In solid-state thin film electrochromic devices, an anodic electrochromic layer and a cathodic electrochromic layer, each layer usually made from inorganic metal oxides, are typically separate and distinct from one another and assembled in a spaced-apart relationship. The solid-state thin films are often formed using techniques such as chemical vapor deposition or physical vapor deposition. Such techniques are not attractive economically, however, as they involve cost. In another type of solid-state thin film electrochromic device, two substrates are coated separately with compositions of photo- or thermo-setting monomers or oligomers to form on one of the substrates an electrochromic layer, with the electrochromic material present within the layer being predominantly an inorganic material, and on the other substrate a redox layer. [See Japanese Patent Document JP 63-262,624].

Attempts have been made to prepare electrochromic media from polymers. For example, it has been reported that electrochromic polymer layers may be prepared by dissolving in a solvent organic polymers, which contain no functionality capable of further polymerization, together with an electrochromic compound, and thereafter casting or coating the resulting solution onto an electrode. It has been reported further that electrochromic polymer layers are created upon evaporation of the solvent by pressure reduction and/or temperature elevation. [See e.g., U.S. Pat. Nos. 3,652,149 (Rogers), 3,774,988 (Rogers) and 3,873,185 (Rogers); 4,550,982 (Hirai); Japanese Patent Document JP 52-10,745; and Y. Hirai and C. Tani, "Electrochromism for Organic Materials in Polymeric All-Solid State Systems", *Appl. Phys. Lett.*, 43 (7), 704-05 (1983)]. Use of such polymer solution casting systems has disadvantages, however, including the need to evaporate the solvent prior to assembling devices to form polymer electrochromic layers. This additional processing step adds to the cost of manufacture through increased capital expenditures and energy requirements, involves potential exposure to hazardous chemical vapors and constrains the type of device to be manufactured.

A thermally cured polymer gel film containing a single organic electrochromic compound has also been reported for use in display devices. [See H. Tsutsumi et al., "Polymer Gel Films with Simple Organic Electrochromics for Single-Film Electrochromic Devices", *J. Polym. Sci.*, 30, 1725-29 (1992) and H. Tsutsumi et al., "Single Polymer Gel Film Electrochromic Device", *Electrochimica Acta*, 37, 369-70 (1992)]. The gel film reported therein was said to possess a solvent-like environment around the electrochromic compounds of that film. This gel film was reported to turn brown, and ceased to perform color-bleach cycles, after only 35,200 color-bleach cycles.

SUMMARY OF THE INVENTION

The present invention provides electrochromic polymeric solid films ("polychromatic solid films") that are prepared by an in situ curing process different from processes used to prepare the electrochromic polymer layers known to date, and employ different combinations of electrochromic compounds than those that have been placed heretofore in solid electrochromic media. The resulting polychromatic solid films possess beneficial properties and characteristics, and offer superior results, compared to the known electrochromic media. For instance, polychromatic solid films overcome well-known manufacturing and use concerns such as hydrostatic pressure that is particularly troublesome in large area vertically mounted panels, such as windows, or large area mirrors, such as Class 8 truck mirrors. Thus, polychromatic solid films are extremely well-suited to commercial applications, like the manufacture and use of electrochromic devices. Such electrochromic devices include, but are not limited to, electrochromic mirrors—e.g., vehicular, for instance, truck mirrors, particularly large area truck mirrors, automotive interior and exterior mirrors, architectural or specialty mirrors, like those useful in periscopic or dental and medical applications; electrochromic glazings—e.g., architectural, such as those useful in the home, office or other edifice, aeronautical, such as those useful in aircraft, or vehicular glazings, for instance, windows, such as windshields, side windows and backlights, sun roofs, sun visors or shade bands and optically attenuating contrast filters, such as contrast enhancement filters, suitable for use in connection with cathode ray tube monitors and the like; electrochromic privacy or security partitions; electrochromic

solar panels, such as sky lights; electrochromic information displays; electrochromic lenses and eye glass. Moreover, in view of the teaching herein, any of such electrochromic devices may be manufactured to be segmented so that a portion of the device colors preferentially to change the light transmittance thereof.

The present invention also provides novel electrochromic monomer compositions comprising anodic electrochromic compounds, cathodic electrochromic compounds, a monomer component and a plasticizer that are useful in the formation of such polychromatic solid films. More specifically, each of the electrochromic compounds are organic or organometallic compounds. Electrochromic monomer compositions may also include, but are not limited to, either individually or in combination, cross-linking agents, photoinitiators, photosensitizers, ultraviolet stabilizing agents, electrolytic materials, coloring agents, spacers, anti-oxidizing agents, flame retarding agents, heat stabilizing agents, compatibilizing agents, adhesion promoting agents, coupling agents, humectants and lubricating agents.

The present invention further provides novel processes for making polychromatic solid films by transforming such novel electrochromic monomer compositions into polychromatic solid films through exposure to electromagnetic radiation for a time sufficient to effect an in situ cure.

The present invention still further provides electrochromic devices, such as those referred to above, particularly rearview mirrors, windows and sun roofs for automobiles, which devices are stable to outdoor weathering, particularly weathering observed due to prolonged exposure to ultraviolet radiation from the sun, and are safety protected against impact from an accident. Such outdoor weathering and safety benefits are achieved by manufacturing these devices using as a medium of varying transmittance to light the polychromatic solid films prepared by the in situ cure of an electrochromic monomer composition containing a monomer component that is capable of further polymerization.

The present invention provides for the first time, among other things (1) polychromatic solid films that may be transformed from electrochromic monomer compositions by an in situ curing process through exposure to electromagnetic radiation, such as ultraviolet radiation; (2) a transformation during the in situ curing process from the low viscosity, typically liquid, electrochromic monomer compositions to polychromatic solid films that occurs with minimum shrinkage and with good adhesion to the contacting surfaces; (3) polychromatic solid films that (a) may be manufactured to be self-supporting and subsequently laminated between conductive substrates, (b) perform well under prolonged coloration, (c) demonstrate a resistance to degradation caused by environmental conditions, such as outdoor weathering and all-climate exposure, particularly demonstrating ultraviolet stability when exposed to the sun, and (d) demonstrate a broad spectrum of color under an applied potential; (4) polychromatic solid films that may be manufactured economically and are amenable to commercial processing; (5) polychromatic solid films that provide inherent safety protection not known to electrochromic media heretofore; and (6) electrochromic monomer compositions that comprise anodic electrochromic compounds and cathodic electrochromic compounds, which compounds are organic or organometallic.

The self-supporting nature of polychromatic solid films provides many benefits to the electrochromic devices manufactured therewith, including the elimination of a compartmentalization means, such as a sealing means, since no such

5

means is required to confine or contain a polychromic solid film within an electrochromic device. That polychromic solid films may be manufactured to be self-supporting also enhances processibility, and vitiates obstacles well-recognized in the manufacturing of electrochromic devices containing known electrochromic media, especially those that are to be vertically mounted in their intended use.

Moreover, since the electrochromic compounds are not free to migrate within polychromic solid films, in contrast to electrochromic compounds present within a liquid solution-phase environment, polychromic solid films do not pose the segregation concern as do solution-phase electrochromic devices; rather, polychromic solid films perform well under prolonged coloration.

Further, from a safety perspective, in the event that electrochromic devices manufactured with polychromic solid films should break or become damaged due to the impact from an accident, no liquid is present to seep therefrom since the polychromic solid films of the present invention are indeed solid. Also, the need to manufacture electrochromic devices with tempered glass, or with at least one of the substrates being of a laminate assembly, to reduce potential lacerative injuries is obviated since polychromic solid films, positioned between, and in abutting relationship with, the conductive surface of the two substrates, exhibit good adhesion to the contacting surfaces. Thus, polychromic solid films should retain any glass shards that may be created and prevent them from scattering. Therefore, a safety protection feature inherent to polychromic solid films is also provided herein, making polychromic solid films particularly attractive for use in connection with electrochromic devices, such as mirrors, windows, sun roofs, shade bands, eye glass and the like.

Polychromic solid films embody a novel and useful technology within the electrochromic art, whose utility will become more readily apparent and more greatly appreciated by those of skill in the art through a study of the detailed description taken in conjunction with the figures which follow hereinafter.

BRIEF DESCRIPTION OF THE FIGURES

FIG. 1 depicts a sectional view of an electrochromic device employing an electrochromic polymeric solid film according to the present invention.

FIG. 2 depicts a perspective view of an electrochromic glazing assembly according to the present invention.

The depictions in these figures are for illustrative purposes and thus are not drawn to scale.

DETAILED DESCRIPTION OF THE INVENTION

In accordance with the teaching of the present invention, polychromic solid films may be prepared by exposing an electrochromic monomer composition to electromagnetic radiation for a time sufficient to transform the electrochromic monomer composition into a polychromic solid film. This in situ curing process initiates polymerization of, and typically completely polymerizes, an electrochromic monomer composition, normally in a liquid state, by exposure to electromagnetic radiation to form a polychromic solid film, whose surface and cross-sections are substantially tack-free.

The electrochromic monomer compositions are comprised of anodic electrochromic compounds, cathodic electrochromic compounds, each of which are organic or organometallic compounds, a monomer component and a

6

plasticizer. In addition, cross-linking agents, photoinitiators, photosensitizers, ultraviolet stabilizing agents, electrolytic materials, coloring agents, spacers, anti-oxidizing agents, flame retarding agents, heat stabilizing agents, compatibilizing agents, adhesion promoting agents, coupling agents, humectants and lubricating agents and combinations thereof may also be added. In the preferred electrochromic monomer compositions, the chosen monomer component may be a polyfunctional monomer, such as a difunctional monomer, trifunctional monomer, or a higher functional monomer, or a combination of monofunctional monomer and difunctional monomer or monofunctional monomer and cross-linking agent. Those of ordinary skill in the art may choose a particular monomer component or combination of monomer components from those recited in view of the intended application so as to impart the desired beneficial properties and characteristics to the polychromic solid film.

An anodic electrochromic compound suitable for use in the present invention may be selected from the class of chemical compounds represented by the following formulae:

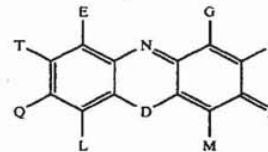

wherein

A is O, S or NRR_1 ;

wherein R and R_1 may be the same or different, and each may be selected from the group consisting of H or any straight- or branched-chain alkyl constituent having from about one carbon atom to about eight carbon atoms, such as CH_3 , CH_2CH_3 , $\text{CH}_2\text{CH}_2\text{CH}_3$, $\text{CH}(\text{CH}_3)_2$, $\text{C}(\text{CH}_3)_3$ and the like; provided that when A is NRR_1 , Q is H, OH or NRR_1 ; further provided that when A is NRR_1 , a salt may be associated therewith; still further provided that when both A and Q are NRR_1 , A and Q need not, but may, be the same functional group;

D is O, S, NR_1 or Se;

E is R_1 , COOH or CONH_2 ; or, E and T, when taken together, represent an aromatic ring structure having six ring carbon atoms when viewed in conjunction with the ring carbon atoms to which they are attached;

G is H;

J is H, any straight- or branched-chain alkyl constituent having from about one carbon atom to about eight carbon atoms, such as CH_3 , CH_2CH_3 , $\text{CH}_2\text{CH}_2\text{CH}_3$, $\text{CH}(\text{CH}_3)_2$, $\text{C}(\text{CH}_3)_3$ and the like, NRR_1 ,



OR_1 , phenyl, 2,4-dihydroxyphenyl or any halogen; or, G and J, when taken together, represent an aromatic ring structure having six ring carbon atoms when viewed in conjunction with the ring carbon atoms to which they are attached;

L is H or OH;

M is H or any halogen;

7

T is R₁, phenyl or 2,4-dihydroxyphenyl; and Q is H, OH or NRR₁; provided that when L and/or Q are OH, L and/or Q may also be salts thereof; further provided that in order to render it electrochemically active in the present context, anodic electrochromic compound I has been previously contacted with a redox agent;

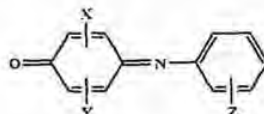

wherein X and Y may be the same or different, and each may be selected from the group consisting of H, any halogen or NRR₁, wherein R and R₁ may be the same or different, and are as defined supra; or, X and Y, when taken together, represent an aromatic ring structure having six ring carbon atoms when viewed in conjunction with the ring carbon atoms to which they are attached; and

Z is OH or NRR₁, or salts thereof; provided that in order to render it electrochemically active in the present context, anodic electrochromic compound II has been previously contacted with a redox agent;

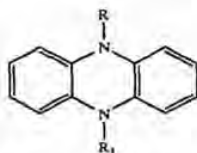

derivatives of 5,10-dihydrobenzazine

wherein R and R₁ may be the same or different, and are defined supra;

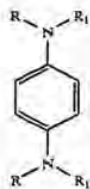

derivatives of 1,4-phenylenediamine

wherein R and R₁ may be the same or different, and are defined supra;

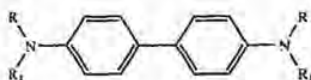

derivatives of benzidine

wherein R and R₁ may be the same or different, and are defined supra;

8

Metallocenes suitable for use as a component of the electrochromic monomer composition include, but are not limited to the following:

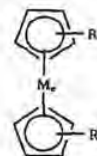

metallocenes and their derivatives

wherein R and R₁ may be the same or different, and each may be selected from the group consisting of H; any straight- or branched-chain alkyl constituent having from about 1 carbon atom to about 8 carbon atoms, such as CH₃, CH₂CH₃, CH₂CH₂CH₃, CH(CH₃)₂, C(CH₃)₃ and the like; acetyl; vinyl; allyl; -(CH₂)_n-OH, wherein n may be an integer in the range of 0 to about 20;

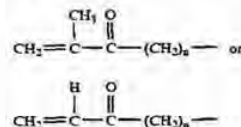

wherein n may be an integer in the range of 0 to about 20; -(CH₂)_n-COOR₂, wherein n may be an integer in the range of 0 to about 20 and R₂ may be any straight- or branched-chain alkyl constituent having from about 1 carbon atom to about 20 carbon atoms, hydrogen, lithium, sodium

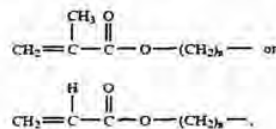

wherein n may be an integer from 0 to about 20. -(CH₂)_n-OR₃, wherein n' may be an integer in the range of 1 to about 12 and R₃ may be any straight- or branched-chain alkyl constituent having from about 1 carbon atom to about 8 carbon atoms,

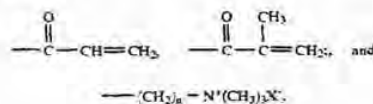

wherein n' may be an integer in the range of 1 to about 12; X may be Cl⁻, Br⁻, I⁻, PF₆⁻, ClO₄⁻ or BF₄⁻; and wherein M_z is Fe, Ni, Ru, Co, Ti, Cr, W, Mo and the like;

9

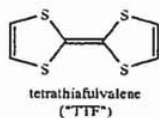

and combinations thereof.

Phenothiazines suitable for use as a component of the electrochromic monomer composition include, but are not limited to, those represented by the following structures:

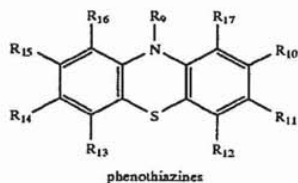

where R_9 may be selected from the group consisting of H; any straight- or branched-chain alkyl constituent having from about 1 carbon atom to about 10 carbon atoms; phenyl; benzyl;

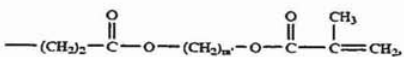
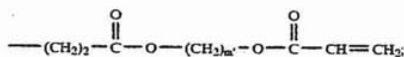
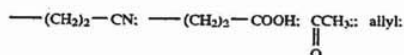

wherein m' may be an integer in the range of 1 to about 8;

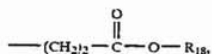

wherein R_{18} may be any straight- or branched-chain alkyl constituent having from about 1 carbon atom to about 8 carbon atoms; and

R_{10} , R_{11} , R_{12} , R_{13} , R_{14} , R_{15} , R_{16} , and R_{17} may be selected from H, Cl, Br, CF_3 , CH_3 , NO_2 , COOH , OH, SCH_3 , OCH_3 , O_2CCH_3 or



and

R_9 and R_{17} , when taken together, form a ring with six atoms (five of which being carbon) having a carbonyl substituent on one of the carbon atoms.

Preferred among phenothiazines 1-A is phenothiazines 2-A to 4-A as depicted in the following structure:

10

VII

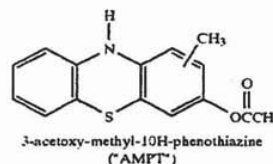

2-A

10

3-A

1-A

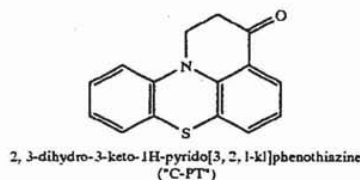

4-A

25

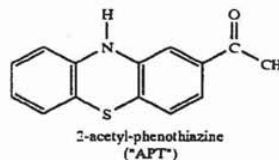

30

An example of a desirable quinone for use as component in the electrochromic monomer composition include, but is not limited to the following structure:

35

5-A

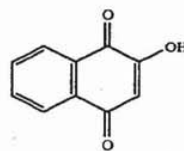

40

45

Combinations of components in the electrochromic monomer composition may be selectively chosen to achieve a desired substantially non-spectral selectivity when the electrochromic element (and the mirror in which the electrochromic element is to function) is dimmed to a colored state.

To render anodic electrochromic compounds I and II electrochemically active in the context of the present invention, a redox pre-contacting procedure must be used. Such a redox pre-contacting procedure is described in the context of preparing anodic compounds for electrochromic solutions in Varaprasad IV and commonly assigned co-pending U.S. patent application Ser. No. 07/935,784 (filed Aug. 27, 1992).

Preferably, anodic electrochromic compound I may be selected from the group consisting of the class of chemical compounds represented by the following formulae:

11

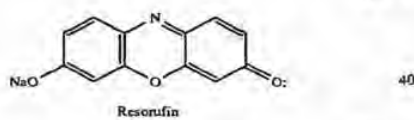
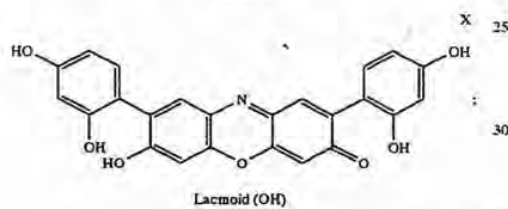
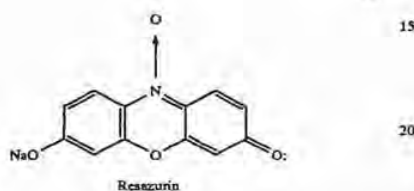
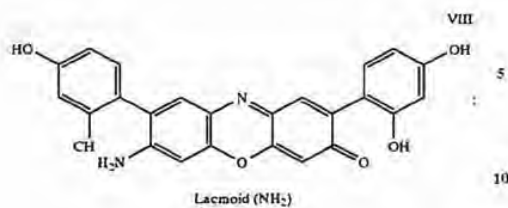

12

-continued

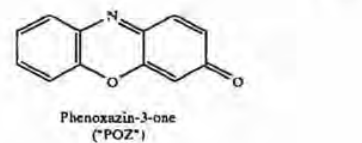
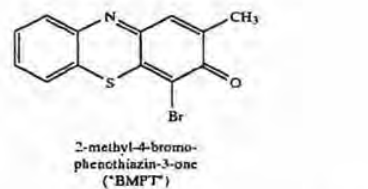
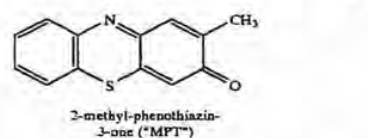
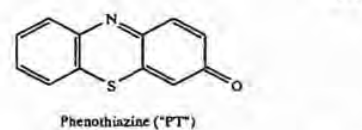
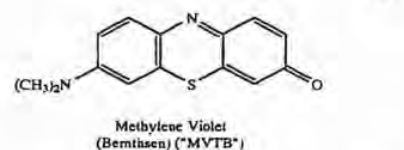
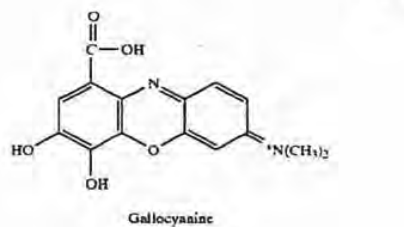

13

-continued

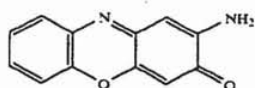
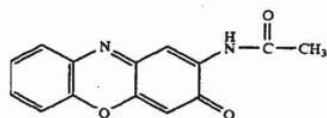
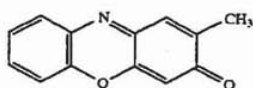
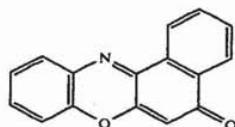
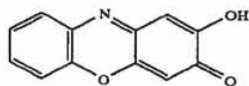
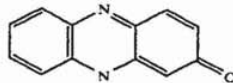
2-amino-phenoxazin-3-one
(*APOZ*)2-acetylamino-phenoxazin-3-one
(*AAPOZ*)2-methyl-phenoxazin-3-one
(*MPOZ*)1,2-benzo-phenoxazin-3-one
(*BPOZ*)2-hydroxy-phenoxazin-3-one
(*HPOZ*)2-keto-N-ethyl-phenazine
(*KEPA*)

14

-continued

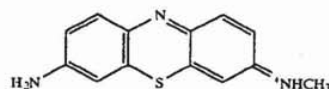
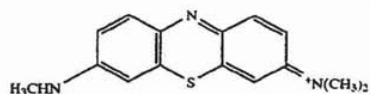
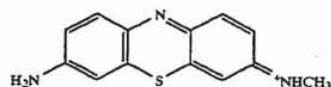
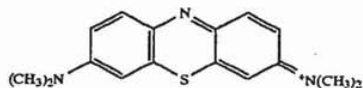
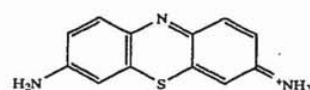
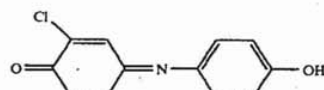
Azure A
(*AA*)Azure B
(*AB*)Azure C
(*AC*)Methylene Blue
(*MB*)Thionin
(*TH*)2,6-dichloro-indophenol
(*DCI*)

XX

5

10

XXI

15

20

XXII

25

30

XXIII

35

40

XXIV

45

50

XXV

55

XXVI

XXVII

XXVIII

XXIX

XXX

XXXI

and combinations thereof.

60 Among the especially preferred anodic electrochromic compounds I are MVTB (XV), PT (XVI), MPT (XVII), and POZ (XIX), with MVTB and MPT being most preferred. Also preferred is the reduced form of MPT which results from the redox pre-contacting procedure referred to above.

65

15

and has been thereafter isolated. This reduced and isolated form of MPT—RMPT [XVII(a)]—is believed to be 2-methyl-3-hydroxyphenathiazine, which is represented by the following chemical formula

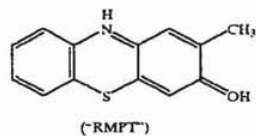

and salts thereof.

In addition, a preferred anodic electrochromic compound II is

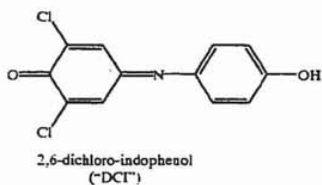

and salts thereof.

Likewise, preferred among anodic electrochromic compound III are 5,10-dihydro-5,10-dimethylphenazine (“DMPA”) and 5,10-dihydro-5,10-diethylphenazine (“DEPA”), with DMPA being particularly preferred.

As a preferred anodic electrochromic compound VI, metallocenes, such as ferrocene, wherein M_e is iron and R and R_1 are each hydrogen, and alkyl derivatives thereof, may also be used advantageously in the context of the present invention.

The salts referred to in connection with the anodic electrochromic compounds include, but are not limited to, alkali metal salts, such as lithium, sodium, potassium and the like. In addition, when A is NRR_1 , tetrafluoroborate (“ BF_4^- ”), perchlorate (“ ClO_4^- ”), trifluoromethane sulfonate (“ $CF_3SO_3^-$ ”), hexafluorophosphate (“ PF_6^- ”), acetate (“ Ac^- ”) and any halogen may be associated therewith. Moreover, the ring nitrogen atom in anodic electrochromic compound I may also appear as an N-oxide.

Any one or more of anodic electrochromic compounds I, II, III, IV, V, VI or VII may also be advantageously combined, in any proportion, within an electrochromic monomer composition and thereafter transformed into a polychromic solid film to achieve the results so stated herein. Of course, as regards anodic electrochromic compounds I and II, it is necessary to contact those compounds with a redox agent prior to use so as to render them electrochemically active in the present invention. Upon the application of a potential thereto, such combinations of anodic electrochromic compounds within a polychromic solid film may often generate color distinct from the color observed from polychromic solid films containing individual anodic electrochromic compounds. A preferred combination of anodic electrochromic compounds in this invention is the combination of anodic electrochromic compounds III and VI. Nonetheless, those of ordinary skill in the art may make appropriate choices among individual anodic electrochromic compounds and combinations thereof, to prepare a

16

polychromic solid film capable of generating a color suitable for a particular application.

A choice of a cathodic electrochromic compound for use herein should also be made. The cathodic electrochromic compound may be selected from the class of chemical compounds represented by the following formulae:

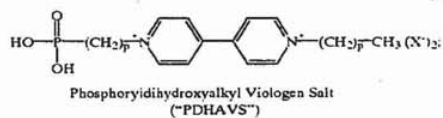
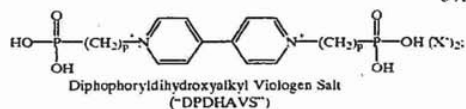
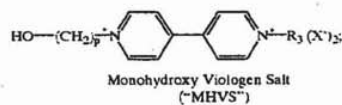
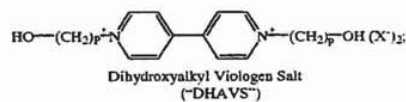
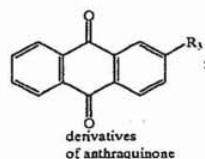
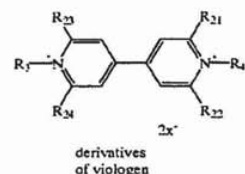

wherein R_3 , R_4 , R_{21} , R_{22} , R_{23} and R_{24} may be the same or different and each may be selected from the group consisting of H, any straight- or branched-chain alkyl constituent having from about one carbon atom to about eight carbon atoms, or any straight- or branched-chain alkyl- or alkoxyphenyl, wherein the alkyl or alkoxy constituent contains from about one carbon atom to about eight carbon atoms;

17



wherein n' may be an integer in the range of 1 to 12;



wherein R_s may be H or CH₃, and n' may be an integer in the range of 1 to 12; HO-(CH₂)_{n'}, wherein n' may be an integer in the range of 1 to 12; and HOOC-(CH₂)_{n'}, wherein n' may be an integer in the range of 1 to 12;

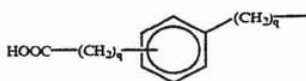

and

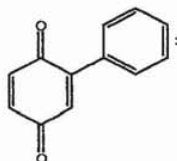

Phenyl-1,4-benzoquinone

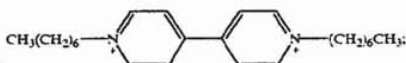

2 SS⁺

Heptylviologen
Styrylsulfonate
("HVSS")

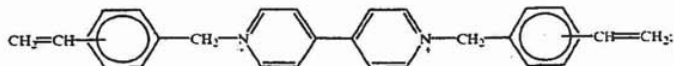

2 ClO₄⁻

Distyrylmethylviologen
Perchlorate
(mixed isomers)
("DSMVCIO₄")

18

-continued

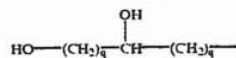

5

wherein q may be an integer in the range of 0 to 12; wherein each p is independently an integer from 1 to 12; and wherein X is selected from the group consisting of BF₄⁻, ClO₄⁻, CF₃SO₃⁻, styrylsulfonate ("SS⁻"), 2-acrylamido-2-methylpropane-sulfonate, acrylate, methacrylate, 3-sulfopropylacrylate, 3-sulfopropyl-methacrylate, PF₆⁻, Ac⁻, HO-(R_{2.5})-SO₃⁻ and HOOC-(R_{2.5})-SO₃⁻, wherein R_{2.5} can be any straight- or branched-chain alkyl constituent having from about 1 carbon atom to about 8 carbon atoms, an aryl or a functionalized aryl, an alkyl or aryl amide, a branched or linear chain polymer, such as polyvinyls, polyethers and polyesters bearing at least one and preferably multiple, hydroxyl and sulphate functionalities and any halide; and combinations thereof.

In one preferred embodiment R_{2.5} can be:

20



25

4-hydroxyphenylsulfonate (or its isomers)

or the copolymer derived from acrylamidomethylpropane-sulfonic acid (AMPS) and caprolactone acrylate.

30

Specific cathodic electrochromic compounds useful in the context of the present invention include:

XXXIV

XXXV

XXXVI

-continued

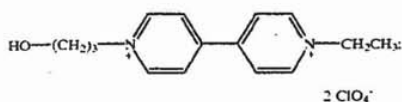

Ethylhydroxypropylviologen
Perchlorate
("EHPVClO₄")

XXXVII

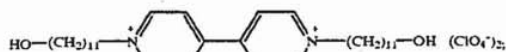

Hydroxyundecyl Viologen Perchlorate
("HUVClO₄")

XXXVIII

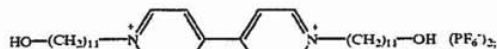

Hydroxyundecyl Viologen Hexafluorophosphate
("HUVPF₆")

XXXIX

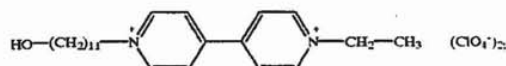

Ethylhydroxyundecyl Viologen Perchlorate
("EHUVClO₄")

XXXX

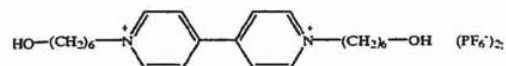

Hydroxyhexyl Viologen Hexafluorophosphate
("HHVPF₆")

XXXXI

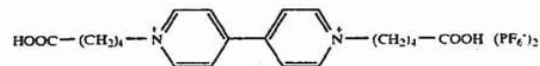

Divalericacid Viologen Hexafluorophosphate
("DVAVPF₆")

XXXXII

Preferably, R₃ and R₄ are ethyl, n-heptyl, hydroxyhexyl or hydroxyundecyl. Thus, when X is PF₆⁻, ClO₄⁻ or BF₄⁻, preferred cathodic electrochromic compounds are ethylviologen perchlorate ("EVCIO₄"), heptylviologen tetrafluoroborate ("HVBF₄"), hydroxyundecyl viologen hexafluorophosphate ("HUVPF₆"), ethylhydroxyundecyl viologen perchlorate ("EHUVClO₄"), hydroxyhexyl viologen hexafluorophosphate ("HHVPF₆"), and divalericacid viologen hexafluorophosphate ("DVAVPF₆").

The above anodic electrochromic compounds and cathodic electrochromic compounds may be chosen so as to achieve a desired color when the polychromic solid film in which they are present (and the device in which the polychromic solid film is contained) is colored to a dimmed state. For example, electrochromic automotive mirrors manufactured with polychromic solid films should preferably bear a

blue or substantially neutral color when colored to a dimmed state. And, electrochromic optically attenuating contrast filters, such as contrast enhancement filters, manufactured with polychromic solid films should preferably bear a substantially neutral color when colored to a dimmed state.

The plasticizer chosen for use in the present invention should maintain the homogeneity of the electrochromic monomer compositions while being prepared, used and stored, and prior to, during and after exposure to electromagnetic radiation. As a result of its combination within the electrochromic monomer composition or its exposure to electromagnetic radiation, the plasticizer of choice should not form by-products that are capable of hindering, or interfering with, the homogeneity and the electrochemical efficacy of the resulting polychromic solid film. The occurrence of any of these undesirable events during the in situ

curing process, whether at the pre-cure, cure or post-cure phase of the process for preparing polychromic solid films, may interfere with the process itself, and may affect the appearance and effectiveness of the resulting polychromic solid films, and the electrochromic devices manufactured with the same. The plasticizer also may play a role in defining the physical properties and characteristics of the polychromic solid films of the present invention, such as toughness, flex modulus, coefficient of thermal expansion, elasticity, elongation and the like.

Suitable plasticizers for use in the present invention include, but are not limited to, triglyme, tetraglyme, acetonitrile, benzylacetone, 3-hydroxypropionitrile, methoxypropionitrile, 3-ethoxypropionitrile, butylene carbonate, propylene carbonate, ethylene carbonate, glycerine carbonate, 2-acetylbutyrolactone, cyanoethyl sucrose, γ -butyrolactone, 2-methylglutaronitrile, N,N'-dimethylformamide, 3-methylsulfolane, methylethyl ketone, cyclopentanone, cyclohexanone, 4-hydroxy-4-methyl-2-pentanone, acetophenone, glutaronitrile, 3,3'-oxydipropionitrile, 2-methoxyethyl ether, triethylene glycol dimethyl ether and combinations thereof. Particularly preferred plasticizers among that group are benzylacetone, 3-hydroxypropionitrile, propylene carbonate, ethylene carbonate, 2-acetylbutyrolactone, cyanoethyl sucrose, triethylene glycol dimethyl ether, 3-methylsulfolane and combinations thereof.

To prepare a polychromic solid film, a monomer should be chosen as a monomer component that is capable of in situ curing through exposure to electromagnetic radiation, and that is compatible with the other components of the electrochromic monomer composition at the various stages of the in situ curing process. The combination of a plasticizer with a monomer component (with or without the addition of a difunctional monomer or a cross-linking agent) should preferably be in an equivalent ratio of between about 75:25 to about 10:90 to prepare polychromic solid films with superior properties and characteristics. Of course, the art-skilled should bear in mind that the intended application of a polychromic solid film will often dictate its particular properties and characteristics, and that the choice and equivalent ratio of the components within the electrochromic monomer composition may need to be varied to attain a polychromic solid film with the desired properties and characteristics.

Among the monomer components that may be advantageously employed in the present invention are monomers having at least one reactive functionality rendering the compound capable of polymerization or further polymerization by an addition mechanism, such as vinyl polymerization or ring opening polymerization. Included among such monomers are oligomers and polymers that are capable of further polymerization. For monomers suitable for use herein, see generally those commercially available from Monomer-Polymer Labs., Inc., Philadelphia, Pa.; Sartomer Co., Exton, Pa.; and Polysciences, Inc., Warrington, Pa.

Monomers capable of vinyl polymerization, suitable for use herein, have as a commonality the ethylene functionality, as represented below:



wherein R_6 , R_7 and R_8 may be the same or different, and are each selected from a member of the group consisting of

hydrogen; halogen; alkyl, cycloalkyl, poly-cycloalkyl, heterocycloalkyl and alkyl and alkenyl derivatives thereof; alkenyl, cycloalkenyl, cycloalkadienyl, poly-cycloalkadienyl and alkyl and alkenyl derivatives thereof; hydroxyalkyl; hydroxyalkenyl; alkoxyalkyl; alkoxyalkenyl; cyano; amido; phenyl; benzyl and carboxylate, and derivatives thereof.

Preferred among these vinyl monomers are the ethylene carboxylate derivatives known as acrylates—i.e., wherein at least one of R_6 , R_7 , and R_8 are carboxylate groups or derivatives thereof. Suitable carboxylate derivatives include, but are not limited to alkyl, cycloalkyl, poly-cycloalkyl, heterocycloalkyl and alkyl and alkenyl derivatives thereof; alkenyl, cycloalkenyl, poly-cycloalkenyl and alkyl and alkenyl derivatives thereof; mono- and poly-hydroxyalkenyl; alkoxyalkyl; alkoxyalkenyl and cyano.

Among the acrylates that may be advantageously employed herein are mono- and poly-acrylates (bearing in mind that poly-acrylates function as cross-linking agents as well, see *infra*), such as 2-hydroxyethyl acrylate, 2-hydroxyethyl methacrylate, methylene glycol monoacrylate, diethylene glycol monomethacrylate, 2-hydroxypropyl acrylate, 2-hydroxypropyl methacrylate, 3-hydroxypropyl acrylate, 3-hydroxypropyl methacrylate, dipropylene glycol monomethacrylate, 2,3-dihydroxypropyl methacrylate, methyl acrylate, ethyl acrylate, n-propyl acrylate, i-propyl acrylate, n-butyl acrylate, s-butyl acrylate, n-pentyl acrylate, 2-ethylhexyl acrylate, methyl methacrylate, ethyl methacrylate, n-propyl methacrylate, i-propyl methacrylate, n-butyl methacrylate, s-butyl methacrylate, n-pentyl methacrylate, benzyl methacrylate, methoxyethyl acrylate, methoxyethyl methacrylate, triethylene glycol monoacrylate, glycerol monoacrylate, glycerol monomethacrylate, allyl methacrylate, benzyl acrylate, caprolactone acrylate, cyclohexyl acrylate, cyclohexyl methacrylate, 2-ethoxyethyl acrylate, 2-ethoxyethyl methacrylate, 2-(2-ethoxyethoxy)ethyl acrylate, glycidyl methacrylate, n-hexyl acrylate, n-hexyl methacrylate, isobornyl acrylate, isobornyl methacrylate, i-decyl acrylate, i-decyl methacrylate, i-octyl acrylate, lauryl acrylate, lauryl methacrylate, 2-methoxyethyl acrylate, n-octyl acrylate, 2-phenoxyethyl acrylate, 2-phenoxyethyl methacrylate, stearyl acrylate, stearyl methacrylate, tetrahydrofurfuryl acrylate, tetrahydrofurfuryl methacrylate, tridecyl methacrylate, 1,4-butanediol diacrylate, 1,4-butanediol dimethacrylate, 1,3-butylene glycol diacrylate, 1,3-butylene glycol dimethacrylate, diethylene glycol diacrylate, diethylene glycol dimethacrylate, ethylene glycol diacrylate, ethoxylated bisphenol A dimethacrylate, ethylene glycol dimethacrylate, 1,6-hexanediol diacrylate, 1,6-hexanediol dimethacrylate, neopentyl glycol diacrylate, neopentyl glycol dimethacrylate, polyethylene glycol diacrylate, polyethylene glycol dimethacrylate, tetraethylene glycol diacrylate, tetraethylene glycol dimethacrylate, triethylene glycol diacrylate, triethylene glycol dimethacrylate, tripropylene glycol diacrylate, dipentaerythritol pentaacrylate, ethoxylated pentaerythritol triacrylate, pentaerythritol tetraacrylate, pentaerythritol triacrylate, trimethylolpropane triacrylate, trimethylolpropane trimethacrylate, tris(2-hydroxyethyl)-isocyanurate triacrylate, tris(2-hydroxyethyl)-isocyanurate trimethacrylate, polyethylene glycol monoacrylate, polyethylene glycol monomethacrylate, polypropylene glycol monoacrylate, polypropylene glycol monomethacrylate, hydroxyethyl cellulose acrylate, hydroxyethyl cellulose methacrylate, methoxy poly(ethyleneoxy) ethylacrylate, methoxy poly

(ethyleneoxy) ethylmethacrylate and combinations thereof. For a further recitation of suitable acrylates for use herein, see those acrylates available commercially from Monomer-Polymer Labs, Inc.; Polysciences, Inc. and Sartomer Co. Also, those of ordinary skill in the art will appreciate that derivatized acrylates in general should provide beneficial properties and characteristics to the resulting polychromic solid film.

Other monomers suitable for use herein include styrenes, unsaturated polyesters, vinyl ethers, acrylamides, methyl acrylamides and the like.

Other monomers capable of addition polymerization include isocyanates, polyols, amines, polyamines, amides, polyamides, acids, polyacids, compounds comprising an active methylene group, ureas, thiols, etc. Preferably, such monomers have a functionality of 2 or greater. For example, the monomer composition can include isocyanates such as hexamethylene diisocyanate (HDI); toluene diisocyanate (TDI including 2, 4 and 2, 6 isomers); diphenylmethane diisocyanate (MDI); isocyanate tipped prepolymers such as those prepared from a diisocyanate and a polyol; condensates produced from hexamethylene diisocyanate including biuret type and trimer type (also known as isocyanurate), as is known in the urethane chemical art. A recitation of various monomers suitable to use in the electrochromic monomer composition is given in the following Table 1.

butanediol glycidyl ether, 2,3-epoxypropyl-4-(2,3-epoxypropoxy) benzoate, 4,4'-bis-(2,3-epoxypropoxy) biphenyl and the like.

Also, particularly preferred are the cycloalkyl epoxides sold under the "CYRACURE" tradename by Union Carbide Chemicals and Plastics Co., Inc., Danbury, Conn., such as the "CYRACURE" resins UVR-6100 (mixed cycloalkyl epoxides), UVR-6105 (3,4-epoxycyclohexylmethyl-3,4-epoxycyclohexane carboxylate), UVR-6110 (3,4-epoxycyclohexylmethyl-3,4-epoxycyclohexane carboxylate) and UVR-6128 [bis-(3,4-epoxycyclohexyl) adipate], and the "CYRACURE" diluents UVR-6200 (mixed cycloalkyl epoxides) and UVR-6216 (1,2-epoxyhexadecane); those epoxides commercially available from Dow Chemical Co., Midland, Mich., such as D.E.R. 736 epoxy resin (epichlorohydrin-polyglycol reaction product), D.E.R. 755 epoxy resin (diglycidyl ether of bisphenol A-diglycidyl ether of polyglycol) and D.E.R. 732 epoxy resin (epichlorohydrin-polyglycol reaction product), and the NOVOLAC epoxy resins such as D.E.N. 431, D.E.N. 438 and D.E.N. 439 (phenolic epoxides), and those epoxides commercially available from Shell Chemical Co., Oak Brook, Ill., like the "EPON" resins 825 and 1001F (epichlorohydrin-bisphenol A type epoxy resins).

Other commercially available epoxide monomers that are particularly well-suited for use herein include those com-

TABLE 1

Monomers suitable to use in the electrochromic monomer composition				
Type	Trade Name	Product No.	Supplier	Location
Isocyanate	Tolonate	HDT (Isocyanurate)	Rhone-Poulenc Inc.	Princeton, NJ
Isocyanate	Tolonate	HDB (Biuret)	Rhone-Poulenc Inc.	Princeton, NJ
Isocyanate	ISONATE	modified MDI	Dow Chemical	Midland, MI
Isocyanate	PAPI	polymeric MDI	Dow Chemical	Midland, MI
Isocyanate	RUBINATE	9043 MDI	ICI	Sterling Heights, MI
Isocyanate	DESMODUR	N-100	Miles	Pittsburgh, PA
Isocyanate	TYCEL	7351	Liofol Co.	Cary, NC
Polyol	VORANOL	polyether polyols	Dow Chemical	Midland, MI
Polyol	VORANOL	copolymer polyols	Dow Chemical	Midland, MI
Polyol	ARCOL	E-786	Arco Chemical	Hinsdale, IL
Polyol	ARCOL	LHT-112	Arco Chemical	Hinsdale, IL
Polyol	ARCOL	E-351	Arco Chemical	Hinsdale, IL
Polyol	LEXOREZ	1931-50	Inolex Chemical Co.	Philadelphia, PA
Polyol	LEXOREZ	1842-90	Inolex Chemical Co.	Philadelphia, PA
Polyol	LEXOREZ	1405-65	Inolex Chemical Co.	Philadelphia, PA
Polyol	LEXOREZ	1150-110	Inolex Chemical Co.	Philadelphia, PA
Polyol	DESMOPHEN	1700	Miles	Pittsburgh, PA
Tin Catalyst	DABCO	T-9	Air Products and Chemical Inc.	Allentown, PA
Tin Catalyst	DABCO	T-1	Air Products and Chemical Inc.	Allentown, PA
Tin Catalyst	DABCO	T-120	Air Products and Chemical Inc.	Allentown, PA

In situ cure can be facilitated by inclusion of organometallic catalysts in the electrochromic monomer composition. Examples of such catalysts include dibutyl tin dilaurate, dibutyl tin diacetate, and dibutyl tin dioctoate. Other catalysts can include organometallic compounds of bismuth, iron, tin, titanium, cobalt, nickel, antimony, vanadium, cadmium, mercury, aluminum, lead, zinc, barium, and thorium. Also, amines such as tertiary amines can be used.

Monomers capable of ring opening polymerization suitable for use herein include epoxides, lactones, lactams, dioxepanes, spiro orthocarbonates, unsaturated spiro orthoesters and the like.

Preferred among these ring opening polymerizable monomers are epoxides and lactones. Of the epoxides suitable for use herein, preferred are cyclohexene oxide, cyclopentene oxide, glycidyl i-propyl ether, glycidyl acrylate, furfuryl glycidyl ether, styrene oxide, ethyl-3-phenyl glycidate, 1,4-

mercially available under the "ENVIBAR" tradename from Union Carbide Chemicals and Plastics Co., Inc., Danbury, Conn., such as "ENVIBAR" UV 1244 (cycloalkyl epoxides).

In addition, derivatized urethanes, such as acrylated (e.g., mono- or poly-acrylated) urethanes; derivatized heterocycles, such as acrylated (e.g., mono- or poly-acrylated) heterocycles, like acrylated epoxides, acrylated lactones, acrylated lactams; and combinations thereof, capable of undergoing addition polymerizations, such as vinyl polymerizations and ring opening polymerizations, are also well-suited for use herein.

Many commercially available ultraviolet curable formulations are well-suited for use herein as a monomer component in the electrochromic monomer composition. Among those commercially available ultraviolet curable formulations are acrylated urethanes, such as the acrylated alkyl

urethane formulations commercially available from Sartomer Co., including Low Viscosity Urethane Acrylate (Flexible) (CN 965), Low Viscosity Urethane Acrylate (Resilient) (CN 964), Urethane Acrylate (CN 980), Urethane Acrylate/TPGDA (CN 966 A80), Urethane Acrylate/I BOA (CN 966 J75), Urethane Acrylate/EOEOEA (CN 966 H90), Urethane Acrylate/TPGDA (CN 965 A80), Urethane Acrylate/EOTMPTA (CN 964 E75), Urethane Acrylate/EOEOEA (CN 966 H90), Urethane Acrylate/TPGDA (CN 963 A80), Urethane Acrylate/EOTMPTA (CN 963 E75), Urethane Acrylate (Flexible) (CN 962), Urethane Acrylate/EOTMPTA (CN 961 E75), Urethane Acrylate/EOEOEA (CN 961 H90), Urethane Acrylate (Hard) (CN 955), Urethane Acrylate (Hard) (CN 960) and Urethane Acrylate (Soft) (CN 953), and acrylated aromatic urethane formulations, such as those sold by Sartomer Co., may also be used herein, including Hydrophobic Urethane Methacrylate (CN 974), Urethane Acrylate/TPGDA (CN 973 A80), Urethane Acrylate/I BOA (CN 973 J75), Urethane Acrylate/EOEOEA (CN 973 H90), Urethane Acrylate (Flexible) (CN 972), Urethane Acrylate (Resilient) (CN 971), Urethane Acrylate/TPGDA (CN 971 A80), Urethane Acrylate/TPGDA (CN 970 A60), Urethane Acrylate/EOTMPTA (CN 970 E60) and Urethane Acrylate/EOEOEA (CN 974 H75). Other acrylated urethane formulations suitable for use herein may be obtained commercially from Monomer-Polymer Labs, Inc. and Polysciences, Inc.

Other ultraviolet curable formulations that may be used herein are the ultraviolet curable acrylated epoxide formulations commercially available from Sartomer Co., such as Epoxidized Soy Bean Oil Acrylate (CN 111), Epoxy Acrylate (CN 120), Epoxy Acrylate/TPGDA (CN 120 A75), Epoxy Acrylate/HDDA (CN 120 B80), Epoxy Acrylate/TMPTA (CN 120 C80), Epoxy Acrylate/GPTA (CN 120 D80), Epoxy Acrylate/Styrene (CN 120 S85), Epoxy Acrylate (CN 104), Epoxy Acrylate/GPTA (CN 104 D80), Epoxy Acrylate/HDDA (CN 104 B80), Epoxy Acrylate/TPGDA (CN 104 A80), Epoxy Acrylate/TMPTA (CN 104 C75), Epoxy Novolac Acrylate/TMPTA (CN 112 C60), Low Viscosity Epoxy Acrylate (CN 114), Low Viscosity Epoxy Acrylate/EOTMPTA (CN 114 E80), Low Viscosity Epoxy Acrylate/GPTA (CN 114 D75) and Low Viscosity Epoxy Acrylate/TPGDA (CN 114 A80).

In addition, "SARBOX" acrylate resins, commercially available from Sartomer Co., like Carboxylated Acid Terminated (SB 400), Carboxylated Acid Terminated (SB 401), Carboxylated Acid Terminated (SB 500), Carboxylated Acid Terminated (SB 500 E50), Carboxylated Acid Terminated (SB 500 K60), Carboxylated Acid Terminated (SB 501), Carboxylated Acid Terminated (SB 510E35), Carboxylated Acid Terminated (SB 520E35) and Carboxylated Acid Terminated (SB 600) may also be advantageously employed herein.

Also well-suited for use herein are ultraviolet curable formulations like the ultraviolet curable conformational coating formulations commercially available under the "QUICK CURE" trademark from the Specialty Coating Systems subsidiary of Union Carbide Chemicals & Plastics Technology Corp., Indianapolis, Ind., and sold under the product designations B-565, B-566, B-576 and BT-5376; ultraviolet curing adhesive formulations commercially available from Loctite Corp., Newington, Conn. under the product names UV OPTICALLY CLEAR ADH, MULTI PURPOSE UV ADHESIVE, "IMPRUV" LV POTTING COMPOUND and "LOCQUIC" ACTIVATOR 707; ultraviolet curable urethane formulations commercially available from Norland Products, Inc., New Brunswick, N.J. and sold

under the product designations "NORLAND NOA 61", "NORLAND NOA 65" and "NORLAND NOA 68"; and ultraviolet curable acrylic formulations commercially available from Dymax Corp., Torrington, Connecticut, including "DYMEX LIGHT-WELD 478".

By employing polyfunctional monomers, like difunctional monomers, or cross-linking agents, cross-linked polychromic solid films may be advantageously prepared.

Such cross-linking tends to improve the physical properties and characteristics (e.g., mechanical strength) of the resulting polychromic solid films. Cross-linking during cure to transform the electrochromic monomer composition into a polychromic solid film may be achieved by means of free radical ionic initiation by the exposure to electromagnetic radiation. This may be accomplished by combining together all the components of the particular electrochromic monomer composition and thereafter effecting cure. Alternatively, cross-links may be achieved by exposing to electromagnetic radiation the electrochromic monomer composition for a time sufficient to effect a partial cure, whereupon further electromagnetic radiation and/or a thermal influence may be employed to effect a more complete in situ cure and transformation into the polychromic solid film.

Suitable polyfunctional monomers for use in preparing polychromic films should have at least two reactive functionalities, and may be selected from, among others, ethylene glycol diacrylate, ethylene glycol dimethacrylate, 1,2-butylene dimethacrylate, 1,3-butylene dimethacrylate, 1,4-butylene dimethacrylate, propylene glycol diacrylate, propylene glycol dimethacrylate, diethylene glycol diacrylate, dipropylene glycol diacrylate, divinyl benzene, divinyl toluene, diallyl tartrate, allyl maleate, divinyl tartrate, triallyl melamine, glycerine trimethacrylate, diallyl maleate, divinyl ether, diallyl monomethylene glycol citrate, ethylene glycol vinyl allyl citrate, allyl vinyl maleate, diallyl itaconate, ethylene glycol diester of itaconic acid, polyester of maleic anhydride with triethylene glycol, polyallyl glucoses (e.g., triallyl glucose), polyallyl sucroses (e.g., pentaallyl sucrose diacrylate), glucose dimethacrylate, pentaerythritol tetraacrylate, sorbitol dimethacrylate, diallyl acconitate, divinyl citrasonate, diallyl fumarate, allyl methacrylate and polyethylene glycol diacrylate.

Ultraviolet radiation absorbing monomers may also be advantageously employed herein. Preferred among such monomers are 1,3-bis-(4-benzoyl-3-hydroxyphenoxy)-2-propylacrylate, 2-hydroxy-4-acryloxyethoxybenzophenone, 2-hydroxy-4-octoxybenzophenone and 4-methacryloxy-2-hydroxybenzophenone, as they perform the dual function of acting as a monomer component, or a portion thereof, and as an ultraviolet stabilizing agent.

Further, ultraviolet absorbing layers may be coated onto, or adhered to, the first substrate and/or second substrate, and preferably the substrate closest to the source of UV radiation, to assist in shielding the electrochromic device from the degradative effect of ultraviolet radiation. Suitable ultraviolet absorbing layers include those recited in U.S. Pat. No. 5,073,012 entitled "Anti-scatter, Ultraviolet Protected, Anti-misting Electro-optical Assemblies", filed Mar. 20, 1990, or as disclosed in copending U.S. Patent application Ser. No. 08/547,578 filed Oct. 24, 1995, the disclosures of which are hereby incorporated by reference herein.

Examples of such layers include a layer of DuPont BE1028D which is a polyvinylbutyral/polyester composite available from E. I. DuPont de Nemours and Company, Wilmington, Del. and SORBALITE™ polymeric UV blockers (available from Monsanto Company, St. Louis, Mo.) which comprise a clear thin polymer film, with UV absorb-

ing chromophores incorporated, such as by covalent bonding, in a polymer backbone. The SORBALITE™ clear thin polymer film when placed on a surface of the substrate closest to the source of UV radiation (such as the sun), efficiently absorbs UV light below about 370 nm with minimal effect on the visible region. Thickness of the SORBALITE™ film is desirably in the range of about 0.1 microns to 1000 microns (or thicker); preferably less than 100 microns; more preferably less than about 25 microns, and most preferably less than about 10 microns. Also, UV absorbing thin films or additives such as cerium oxide, iron oxide, nickel oxide and titanium oxide or such oxides with dopants can be used to protect the electrochromic device from UV degradation. Further as described above, UV absorbing chromophores can be incorporated, such as by covalent bonding, into the solid polymer matrix to impart enhanced resilience to UV radiation. Also near-infrared radiation absorbing species may be incorporated into the solid polymer matrix.

The density of the cross-link within the resulting polychromic solid film tends to increase with the amount and/or the degree of functionality of polyfunctional monomer present in the electrochromic monomer composition. Cross-linking density within a polychromic solid film may be achieved or further increased by adding to the electrochromic monomer composition cross-linking agents, which themselves are incapable of undergoing further polymerization. In addition to increasing the degree of cross-linking within the resulting polychromic solid film, the use of such cross-linking agents in the electrochromic monomer composition may enhance the prolonged coloration performance of the resulting polychromic solid film. Included among such cross-linking agents are polyfunctional hydroxy compounds, such as glycols and glycerol, polyfunctional primary or secondary amino compounds and polyfunctional mercapto compounds. Among the preferred cross-linking agents are pentaerythritol, 2-ethyl-2-(hydroxymethyl)-1,3-propanediol, the poly (caprolactone) diols having molecular weights of 1,250, 2,000 and 3,000, and polycarbonate diol available from Polysciences, Inc. and the polyfunctional hydroxy compounds commercially available under the "TONE" tradename from Union Carbide Chemicals and Plastics Co. Inc., Danbury, Conn., such as ϵ -caprolactone triols (known as "TONE" 0301, "TONE" 0305 and "TONE" 0310). Among the preferred glycols are the poly(ethylene glycols), like those sold under the "CARBOWAX" tradename by the Industrial Chemical division of Union Carbide Corp., Danbury, Conn. such as "CARBOWAX" PEG 200, PEG 300, PEG 400, PEG 540 Blend, PEG 600, PEG 900, PEG 1000, PEG 1450, PEG 3350, PEG 4600, and PEG 8000, with "CARBOWAX" PEG 1450 being the most preferred among this group, and those available from Polysciences, Inc.

Polychromic solid films that perform well under prolonged coloration may be prepared from electrochromic monomer compositions that contain as a monomer component at least some portion of a polyfunctional monomer—e.g., a difunctional monomer. By preferably using polyfunctional monomers having their functional groups spaced apart to such an extent so as to enhance the flexibility of the resulting polychromic solid film, polychromic solid films may be prepared with a minimum of shrinkage during the transformation process and that also perform well under prolonged coloration.

While it is preferable to have electrochromic monomer compositions which contain a monomer component having polyfunctionality in preparing polychromic solid films that

perform well under prolonged coloration, electrochromic monomer compositions that exhibit enhanced resistance to shrinkage when transformed into polychromic solid films preferably contain certain monofunctional monomers. In this regard, depending on the specific application, some physical properties and characteristics of polychromic solid films may be deemed of greater import than others. Thus, superior performance in terms of resistance to shrinkage during in situ curing of the electrochromic monomer composition to the polychromic solid film may be balanced with the prolonged coloration performance of the resulting polychromic solid film to achieve the properties and characteristics desirable of that polychromic solid film.

Those of ordinary skill in the art may make appropriate choices among the herein described monomers—monofunctional and polyfunctional, such as difunctional—and cross-linking agents to prepare a polychromic solid film having beneficial properties and characteristics for the specific application by choosing such combinations of a monofunctional monomer to a polyfunctional monomer or a monofunctional monomer to a cross-linking agent in an equivalent ratio of about 1:1 or greater.

In the preferred electrochromic monomer compositions, photoinitiators or photosensitizers may also be added to assist the initiation of the in situ curing process. Such photoinitiators or photosensitizers enhance the rapidity of the curing process when the electrochromic monomer compositions are exposed to electromagnetic radiation. These materials include, but are not limited to, radical initiation type and cationic initiation type polymerization initiators such as benzoin derivatives, like the *n*-butyl, *i*-butyl and ethyl benzoin alkyl ethers, and those commercially available products sold under the "ESACURE" tradename by Sartomer Co., such as "ESACURE" TZT (trimethyl benzophenone blend), KB1 (benzildimethyl ketal), KB60 (60% solution of benzildimethyl ketal), EB3 (mixture of benzoin *n*-butyl ethers), KIP 100F (α -hydroxy ketone), KT37 (TZT and α -hydroxy ketone blend), ITX (*i*-propylthioxanthone), X15 (ITX and TZT blend), and EDB [ethyl-4-(dimethylamino)-benzoate]; those commercially available products sold under the "IRGACURE" and "DAROCURE" tradenames by Ciba Geigy Corp., Hawthorne, N.Y., specifically "IRGACURE" 184, 907, 369, 500, 651, 261, 784 and "DAROCURE" 1173 and 4265, respectively; the photoinitiators commercially available from Union Carbide Chemicals and Plastics Co. Inc., Danbury, Conn., under the "CYRACURE" tradename, such as "CYRACURE" UVI-6974 (mixed triaryl sulfonium hexafluoroantimonate salts) and UWI-6990 (mixed triaryl sulfonium hexafluorophosphate salts); and the visible light [blue] photoinitiator, *dl*-camphorquinone.

Of course, when those of ordinary skill in the art choose a commercially available ultraviolet curable formulation, it may no longer be desirable to include as a component within the electrochromic monomer composition an additional monomer to that monomer component already present in the commercial formulation. And, as many of such commercially available ultraviolet curable formulations contain a photoinitiator or photosensitizer, it may no longer be desirable to include this optional component in the electrochromic monomer composition. Nevertheless, a monomer, or a photoinitiator or a photosensitizer, may still be added to the electrochromic monomer composition to achieve beneficial results, and particularly when specific properties and characteristics are desired of the resulting polychromic solid film.

With an eye toward maintaining the homogeneity of the electrochromic monomer composition and the polychromic

solid film which results after in situ cure, those of ordinary skill in the art should choose the particular components dispersed throughout, and their relative quantities, appropriately. One or more compatibilizing agents may be optionally added to the electrochromic monomer composition so as to accomplish this goal. Such compatibilizing agents include, among others, combinations of plasticizers recited herein, a monomer component having polyfunctionality and cross-linking agents that provide flexible cross-links. See supra.

Further, monomer compositions can be formed comprising both organic and inorganic monomers. For example, inorganic monomers such as tetraethylorthosilicate, titanium isopropoxide, metal alkoxides, and the like may be included in the monomer composition, and formation of the solid matrix (be it an organic polymer matrix, an inorganic polymer matrix or an organic/inorganic polymer matrix) can proceed via a variety of reaction mechanisms, including hydrolysis/condensation reactions. Also, transition metal-peroxy acid products (such as tungsten peroxy acid product) can be reacted with alcohol to form a peroxy-transition metal derivative (such as peroxytungstic ester derivative), with a recitation of such species being found in U.S. Pat. No. 5,457,218 entitled "Precursor and Related Method of Forming Electrochromic Coatings", invented by J. Cronin et al and issued Oct. 10, 1995, the disclosure of which is hereby incorporated by reference herein, and can be used as a component of the electrochromic monomer composition. Also, the polychromic solid films may optionally be combined with inorganic and organic films such as those of metal oxides (e.g., WO_3 , NiO , IrO_2 , etc.) and organic films such as polyaniline. Examples of such films are found in copending U.S. patent application Ser. No. 08/429,643 filed Apr. 27, 1995, copending U.S. patent application Ser. No. 08/547,578 filed Oct. 24, 1995, and copending U.S. patent application Ser. No. 08/330,090 filed Oct. 26, 1994, the disclosures of which are hereby incorporated by reference herein. Also, the devices of this present invention can benefit from the use of elemental semiconductor layers or stacks, PRM, anti-wetting adaption, synchronous manufacturing, multi-layer transparent conducting stacks incorporating a thin metal layer overcoated with a conducting metal oxide (such as a high reflectivity reflector comprising around 1000 Å of silver metal or aluminum metal, overcoated with about 1500 Å of ITO and with a reflectivity greater than 70% R and a sheet resistance below 5 ohms/square), conducting seals, variable intensity band pass filters, isolation valve vacuum backfilling, cover sheets and on demand displays such as are disclosed in copending U.S. patent application Ser. No. 08/429,643 filed Apr. 27, 1995, the disclosure of which is hereby incorporated by reference herein. Also, as further disclosed in copending U.S. patent application Ser. No. 08/429,643, the solid polymer films of this present invention may comprise within their structure electrochromatically active phthalocyanine-based and/or phthalocyanine-derived moieties including transition metal phthalocyanines such as zirconium phthalocyanine and molybdenum phthalocyanine. Also, the solid polymer films of this invention can be combined with an electron donor (e.g. TiO_2 -spacer (salicylic acid or phosphoric acid bound to the TiO_2)-electron acceptor (a viologen bound to the salicylic acid or to the phosphoric acid) heterodyad such as described also in U.S. patent application Ser. No. 08/429,643. Such donor-spacer-acceptor solid films can function as an electrochromic solid film in combination with the polychromic solid films of the present invention. Further, such as described in U.S. patent application Ser. No. 08/429,643, such chemically modified nanoporous-nanocrystalline films,

such as of TiO_2 with absorbed redox chromophores, can be used in a variety of electrochromic devices and device constructions, including rearview mirrors, glazings, architectural and vehicular glazings, displays, filters, contrast enhancement filters and the like.

Many electrochromic compounds absorb electromagnetic radiation in the about 290 nm to about 400 nm ultraviolet region. Because solar radiation includes an ultraviolet region between about 290 nm to about 400 nm, it is often desirable to shield such electrochromic compounds from ultraviolet radiation in that region. By so doing, the longevity and stability of the electrochromic compounds may be improved. Also, it is desirable that the polychromic solid film itself be stable to electromagnetic radiation, particularly in that region. This may be accomplished by adding to the electrochromic monomer composition an ultraviolet stabilizing agent (and/or a self-screening plasticizer which may act to block or screen such ultraviolet radiation) so as to extend the functional lifetime of the resulting polychromic solid film. Such ultraviolet stabilizing agents (and/or self-screening plasticizers) should be substantially transparent in the visible region and function to absorb ultraviolet radiation, quench degradative free radical reaction formation and prevent degradative oxidative reactions.

As those of ordinary skill in the art will readily appreciate, the preferred ultraviolet stabilizing agents, which are usually employed on a by-weight basis, should be selected so as to be compatible with the other components of the electrochromic monomer composition, and so that the physical, chemical or electrochemical performance of, as well as the transformation into, the resulting polychromic solid film is not adversely affected.

Although many materials known to absorb ultraviolet radiation may be employed herein, preferred ultraviolet stabilizing agents include "UVINUL" 400 [2,4-dihydroxybenzophenone (manufactured by BASF Corp., Wyandotte, Mich.)], "UVINUL" D 49 [2,2'-dihydroxy-4,4'-dimethoxybenzophenone (BASF Corp.)], "UVINUL" N 35 [ethyl-2-cyano-3,3-diphenylacrylate (BASF Corp.)], "UVINUL" N 539 [2-ethylhexyl-2-cyano-3,3'-diphenylacrylate (BASF Corp.)], "UVINUL" M 40 [2-hydroxy-4-methoxybenzophenone (BASF Corp.)], "UVINUL" M 408 [2-hydroxy-4-octoxybenzophenone (BASF Corp.)], "TINUVIN" P [2-(2'-hydroxy-5'-methylphenyl)-triazole] (Ciba Geigy Corp.), "TINUVIN" 327 [2-(3',5'-di-*t*-butyl-2'-hydroxyphenyl)-5-chlorobenzotriazole (Ciba Geigy Corp.)], "TINUVIN" 328 [2-(3',5'-di-*n*-pentyl-2'-hydroxyphenyl)-benzotriazole (Ciba Geigy Corp.)] and "CYASORB UV" 24 [2,2'-dihydroxy-4-methoxy-benzophenone (manufactured by American Cyanamid Co., Wayne, N.J.), with "UVINUL" M 40, "UVINUL M" 408, "UVINUL" N 35 and "UVINUL" N 539 being the most preferred ultraviolet stabilizing agents when used in a by-weight range of about 0.1% to about 15%, with about 4% to about 10% being preferred.

Since solar radiation includes an ultraviolet region only between about 290 nm and 400 nm, the cure wave length of the electrochromic monomer composition, the peak intensity of the source of electromagnetic radiation, and the principle absorbance maxima of the ultraviolet stabilizing agents should be selected to provide a rapid and efficient transformation of the electrochromic monomer compositions into the polychromic solid films, while optimizing the continued long-term post-cure stability to outdoor weathering and all-climate exposure of polychromic solid films.

An electrolytic material may also be employed in the electrochromic monomer composition to assist or enhance

the conductivity of the electrical current passing through the resulting polychromic solid film. The electrolytic material may be selected from a host of known materials, preferred of which are tetraethylammonium perchlorate, tetrabutylammonium tetrafluoroborate, tetrabutylammonium hexafluorophosphate, tetrabutylammonium trifluoromethane sulfonate, lithium salts and combinations thereof, with tetrabutylammonium hexafluorophosphate and tetraethylammonium perchlorate being the most preferred.

In addition, adhesion promoting agents or coupling agents may be used in the preferred electrochromic monomer compositions to further enhance the degree to which the resulting polychromic solid films adhere to the contacting surfaces. Adhesion promoting or coupling agents, which promote such enhanced adhesion, include silane coupling agents, and commercially available adhesion promoting agents like those sold by Sartomer Co., such as Alkoxyolated Trifunctional Acrylate (9008), Trifunctional Methacrylate Ester (9010 and 9011), Trifunctional Acrylate Ester (9012), Aliphatic Monofunctional Ester (9013 and 9015) and Aliphatic Difunctional Ester (9014). Moreover, carboxylated vinyl monomers, such as methacrylic acid, vinyl carboxylic acid and the like may be used to further assist the development of good adhesion to the contacting surfaces.

And, coloring agents, spacers, anti-oxidizing agents, flame retarding agents, heat stabilizing agents and combinations thereof may be added to the electrochromic monomer compositions, choosing of course those materials in appropriate quantities depending upon the specific application of the resulting polychromic solid film. For instance, a blue-tinted electrochromic automotive mirror, such as described herein, may be prepared by dispersing within the electrochromic monomer composition a suitable ultraviolet stable coloring agent, such as "NEOZAPON" BLUE TM 807 (a phthalocyanine blue dye, available commercially from BASF Corp., Parsippany, N.J.) and "NEOPEN" 808 (a phthalocyanine blue dye, available commercially from BASF Corp.).

Polychromic solid films may be prepared within an electrochromic device by introducing an electrochromic monomer composition to a film forming means, such as the vacuum backfilling technique, which fills a cavity of an assembly by withdrawing into the cavity the electrochromic monomer composition while the assembly is in an environment of reduced atmospheric pressure [see e.g., Varaprasad II], the two hole filling technique, where the electrochromic monomer composition is dispensed under pressure into the assembly through one hole while a gentle vacuum is applied at the other hole [see e.g., Varaprasad III], or with the sandwich lamination technique, which contemporaneously creates and fills a cavity of an assembly by placing on one or both substrates either a thermoplastic sealing means to act as a spacing means [see commonly assigned U.S. Pat. No. 5,233,461 (Dorman)] or glass beads of nominal diameter, and then exposing to electromagnetic radiation at least one clear substrate of the assembly constructed by any of the above manufacturing techniques (containing the low viscosity electrochromic monomer composition) for a time sufficient to transform the electrochromic monomer composition into a polychromic solid film.

In connection with such film forming means, spacers, such as glass beads, may be dispensed across the conductive surface of one or both substrates, or dispersed throughout the electrochromic monomer composition which may then be dispensed onto the conductive surface of one or both substrates, to assist in preparing a polychromic solid film which contacts, in abutting relationship, the conductive

surface of the two substrates. Similarly, a pre-established spacing means of solid material, such as tape, pillars, walls, ridges and the like, may also be employed to assist in determining the interpane distance between the substrates in which a polychromic solid film may be prepared to contact, in abutting relationship with, the conductive surface of the two substrates.

Polychromic solid films may also be prepared separately from the electrochromic device, and thereafter placed between, and in abutting relationship with, the conductive surface of the two substrates used in constructing the device. Many known film manufacturing processes may be employed as a film forming means to manufacture polychromic solid films. Included among these processes are calendaring, casting, rolling, dispensing, coating, extrusion and thermoforming. For a non-exhaustive description of such processes, see *Modern Plastics Encyclopedia* 1988, 203-300, McGraw-Hill Inc., New York (1988). For instance, the electrochromic monomer composition may be dispensed or coated onto the conductive surface of a substrate, using conventional techniques, such as curtain coating, spray coating, dip coating, spin coating, roller coating, brush coating or transfer coating.

As described above, polychromic solid films may be prepared as a self-supporting solid film which may thereafter be contacted with conductive substrates.

For instance, an electrochromic monomer composition may be continuously cast or dispensed onto a surface, such as a fluorocarbon surface and the like, to which the polychromic solid film, transformed therefrom by exposure to electromagnetic radiation, does not adhere. In this way, polychromic solid films may be continuously prepared, and, for example, reeled onto a take-up roller and stored for future use. Thus, when a particular electrochromic device is desired, an appropriately shaped portion of the stored polychromic solid film may be cut from the roll using a die, laser, hot wire, blade or other cutting means. This now custom-cut portion of polychromic solid film may be contacted with the conductive substrates to form an electrochromic device.

For example, the custom-cut portion of the polychromic solid film may be laminated between the conductive surface of two transparent conductive coated substrates, such as ITO or tin oxide coated glass substrates, two ITO or tin oxide coated "MYLAR" [polyethylene terephthalate film (commercially available from E. I. du Pont de Nemours and Co., Wilmington, Del.)] substrates or one ITO or tin oxide coated glass substrate and one ITO or tin oxide coated "MYLAR" substrate. To this end, it may be desirable to allow for residual cure in the stored polychromic solid film so that adhesion to the conductive substrates in the laminate to be formed is facilitated and optimized.

In this regard, a polychromic solid film may be prepared by the film forming means of extrusion or calendaring wherein the electrochromic monomer composition is transformed into the polychromic solid film by exposure to electromagnetic radiation prior to, contemporaneously with, or, if the electrochromic monomer composition is sufficiently viscous, after passing through the extruder or calendar. Thereafter, the polychromic solid film may be placed between, and in abutting relationship with, the conductive surface of the substrates, and then construction of the electrochromic device may be completed.

While preparing polychromic solid films, the viscosity of the electrochromic monomer composition may be controlled to optimize its dispensability by adjusting the temperature of (1) the electrochromic monomer composition itself, (2) the substrates on which the electrochromic monomer composi-

tion may be placed to assemble the electrochromic device or (3) the processing equipment used to prepare polychromic solid films (if the polychromic film is to be prepared independently from the substrates of the electrochromic devices). For example, the temperature of the electrochromic monomer composition, the substrates or the equipment or combinations thereof may be elevated to decrease the viscosity of the electrochromic monomer composition. Similarly, the uniformity on the substrate of the dispensed electrochromic monomer composition may be enhanced using lamination techniques, centrifuge techniques, pressure applied from the atmosphere (such as with vacuum bagging), pressure applied from a weighted object, rollers and the like.

The substrates employed in the electrochromic devices of the present invention may be constructed from materials that are substantially inflexible as well as flexible depending on the application to which they are to be used. In this regard, the substrates may be constructed from substantially inflexible substrates, such as glass, laminated glass, tempered glass, optical plastics, such as polycarbonate, acrylic and polystyrene, and flexible substrates, such as "MYLAR" film. Also, the glass substrates suitable for use herein may be tinted specialized glass which is known to significantly reduce ultraviolet radiation transmission while maintaining high visible light transmission. Such glass, often bearing a blue colored tint, provides a commercially acceptable silvery reflection to electrochromic automotive mirrors even when the polychromic solid film is prepared containing an ultraviolet stabilizing agent or other component which may have a tendency to imbue a yellowish appearance to the polychromic solid film. Preferably, blue tinted specialized glass may be obtained commercially from Pittsburgh Plate Glass Industries, Pittsburgh, Pa. as "SOLEXTRA" 7010; Ford Glass Co., Detroit, Mich. as "SUNGLAS" Blue; or Asahi Glass Co., Tokyo, Japan under the "SUNBLUE" tradename.

Whether the chosen substrate is substantially inflexible or flexible, a transparent conductive coating, such as indium tin oxide ("ITO") or doped-tin oxide, is coated on a surface of the substrate making that surface suitable for placement in abutting relationship with a polychromic solid film.

The choice of substrate may influence the choice of processing techniques used to prepare the polychromic solid film or the type of electrochromic device assembled. For example, when assembling an electrochromic device from flexible substrates, an electrochromic monomer composition may be advantageously applied to such flexible substrates using a roll-to-roll system where the flexible substrates are released from rolls (that are aligned and rotate in directions opposite to one another), and brought toward one another in a spaced-apart relationship. In this way, the electrochromic monomer composition may be dispensed or injected onto one of the flexible substrates at the point where the two flexible substrates are released from their respective rolls and brought toward one another, while being contemporaneously exposed to electromagnetic radiation for a time sufficient to transform the electrochromic monomer composition into a polychromic solid film.

The dispensing of the electrochromic monomer composition may be effected through a first injection nozzle positioned over one of the rolls of flexible substrate. A weathering barrier forming material, such as a curing epoxide like an ultraviolet curing epoxide, may be dispensed in an alternating and synchronized manner onto that flexible substrate through a second injection nozzle positioned adjacent to the first injection nozzle. By passing in the path of

these nozzles as a continuously moving ribbon, a flexible substrate may be contacted with the separate polymerizable compositions in appropriate amounts and positions on the flexible substrate.

In manufacturing flexible electrochromic assemblies having a dimension the full width of the roll of flexible substrate, a weathering barrier forming material may be dispensed from the second injection nozzle which may be positioned inboard (typically about 2 mm to about 25 mm) from the leftmost edge of the roll of flexible substrate. The first injection nozzle, positioned adjacent to the second injection nozzle, may dispense the electrochromic monomer composition onto most of the full width of the roll of flexible substrate. A third injection nozzle, also dispensing weathering barrier forming material, may be positioned adjacent to, but inboard from, the rightmost edge of that roll of flexible substrate (typically about 2 mm to about 25 mm). In this manner, and as described above, a continuous ribbon of a flexible electrochromic assembly may be formed (upon exposure to electromagnetic radiation) which, in turn, may be taken up onto a take-up roller. By so doing, a flexible electrochromic assembly having the width of the roll of flexible substrate, but of a particular length, may be obtained by unrolling and cutting to length an electrochromic assembly of a particular size.

Should it be desirable to have multiple flexible electrochromic assemblies positioned in the same taken-up roll, multiple nozzles may be placed appropriately at positions throughout the width of one of the rolls of flexible substrate, and the dispensing process carried out accordingly.

In that regard, a small gap (e.g., about 5 mm to about 50 mm) should be maintained where no dispensing occurs during the introduction of the electrochromic monomer composition and the weathering barrier forming material onto the substrate so that a dead zone is created where neither the electrochromic monomer composition nor the weathering barrier forming material is present. Once the weathering barrier and polychromic solid film have formed (see infra), the electrochromic assembly may be isolated by cutting along the newly created dead zones of the flexible assemblies. This zone serves conveniently as a cutting area to form electrochromic assemblies of desired sizes.

And, the zones outboard of the respective weathering barriers serve as convenient edges for attachment of a means for introducing an applied potential to the flexible electrochromic assemblies, such as bus bars. Similarly, the bisection of the dead zones establishes a convenient position onto which the bus bars may be affixed.

While each of the weathering barrier forming material and the electrochromic monomer composition may be transformed into a weathering barrier and a polychromic solid film, respectively, by exposure to electromagnetic radiation, the required exposures to complete the respective transformations may be independent from one another. The weathering barrier forming material may also be thermally cured to form the weathering barrier.

The choice of a particular electromagnetic radiation region to effect in situ cure may depend on the particular electrochromic monomer composition to be cured. In this regard, typical sources of electromagnetic radiation, such as ultraviolet radiation, include: mercury vapor lamps; xenon arc lamps; "H", "D", "X", "M", "V" and "A" fusion lamps (such as those commercially available from Fusion UV Curing Systems, Buffalo Grove, Ill.); microwave generated ultraviolet radiation; solar power and fluorescent light sources. Any of these electromagnetic radiation sources may use in conjunction therewith reflectors and filters, so as to

focus the emitted radiation within a particular electromagnetic region. Similarly, the electromagnetic radiation may be generated directly in a steady fashion or in an intermittent fashion so as to minimize the degree of heat build-up. Although the region of electromagnetic radiation employed to in situ cure the electrochromic monomer compositions into polychromic solid films is often referred to herein as being in the ultraviolet region, that is not to say that other regions of radiation within the electromagnetic spectrum may not also be suitable. For instance, in certain situations, visible radiation may also be advantageously employed.

Bearing in mind that some or all of the components of the electrochromic monomer composition may inhibit, retard or suppress the in situ curing process, a given source of electromagnetic radiation should have a sufficient intensity to overcome the inhibitive effects of those components so as to enable to proceed successfully the transformation of the electrochromic monomer composition into the polychromic solid film. By choosing a lamp with a reflector and, optionally, a filter, a source which itself produces a less advantageous intensity of electromagnetic radiation may suffice. In any event, the chosen lamp preferably has a power rating of at least about 100 watts per inch (about 40 watts per cm), with a power rating of at least about 300 watts per inch (about 120 watts per cm) being particularly preferred. Most preferably, the wavelength of the lamp and its output intensity should be chosen to accommodate the presence of ultraviolet stabilizing agents incorporated into electrochromic monomer compositions. Also, a photoinitiator or photosensitizer, if used, may increase the rate of in situ curing or shift the wavelength within the electromagnetic radiation spectrum at which in situ curing will occur in the transformation process.

During the in situ curing process, the electrochromic monomer composition will be exposed to a source of electromagnetic radiation that emits an amount of energy, measured in KJ/m^2 , determined by parameters including: the size, type and geometry of the source; the duration of the exposure to electromagnetic radiation; the intensity of the radiation (and that portion of radiation emitted within the region appropriate to effect curing); the absorbance of electromagnetic radiation by any intervening materials, such as substrates, conductive coatings and the like; and the distance the electrochromic monomer composition lies from the source of radiation. Those of ordinary skill in the art will readily appreciate that the polychromic solid film transformation may be optimized by choosing appropriate values for these parameters in view of the particular electrochromic monomer composition.

The source of electromagnetic radiation may remain stationary while the electrochromic monomer composition passes through its path. Alternatively, the electrochromic monomer composition may remain stationary while the source of electromagnetic radiation passes thereover or therearound to complete the transformation into a polychromic solid film. Still alternatively, both may traverse one another, or for that matter remain stationary, provided that the electrochromic monomer composition is exposed to the electrochromic radiation for a time sufficient to effect such in situ curing.

Commercially available curing systems, such as the Fusion UV Curing Systems F-300 B [Fusion UV Curing Systems, Buffalo Grove, Ill.], Hanovia UV Curing System [Hanovia Corp., Newark, N.J.] and RC-500 A Pulsed UV Curing System [Xenon Corp., Woburn, Mass.], are well-suited to accomplish the transformation. Also, a Sunlighter UV chamber fitted with low intensity mercury vapor lamps and a turntable may accomplish the transformation.

Electromagnetic radiation in the near-infrared and far-infrared (including short and long wavelengths from 3 microns to 30 microns and beyond) regions of the electromagnetic spectrum can be used, as can radiation in other regions such as microwave radiation. Thus, for electrochromic monomer compositions responsive to energy input that includes thermal energy, radiant heaters that emit in the infrared region and couple energy into the monomer composition can be used. For compositions responsive to microwave energy, a microwave generator can be used. Also, for systems that respond, for example, to a combination of energy inputs from different regions of the electromagnetic spectrum, a combined energy radiator can be used. For example, the Fusion UV Curing System, Sunlight UV Chamber, Hanovia UV Curing System, and RC-500A Pulsed UV Curing System described above emit energy efficiently in both the ultraviolet region and the infrared region, and thus effect a cure both by photoinitiation and thermally. For systems responsive to thermal influences, ovens, lehrs, convective ovens, induction ovens, heater banks and the like can be used to couple energy into the electrochromic monomer composition by convection, conduction and/or radiation. Also, chemical initiators and catalysts, photo initiators, latent curing agents (such as are described in copending U.S. patent application Ser. No. 08/429,643, the disclosure of which is hereby incorporated by reference herein) and similar chemical accelerants can be used to assist conversion of the electrochromic monomer composition into a cross-linked solid polymer matrix. By customizing and selecting the components of the electrochromic monomer composition, cure can be retarded/suppressed until after the composition is applied within the cavity of the electrochromic cell. Thereafter, by exposure to electromagnetic radiation or thermal influence, cure to the solid polymer matrix polychromic film can be accelerated. Since devices will not typically be consumer used until at least days (often weeks or months) after initial application of the monomer composition within the interpane cell cavity, electrochromic monomer compositions can be composed that in situ cure at room temperature (typically 15° to 30° C.) over time once established within the interpane cavity (for example, within 24 hours). Alternately, electrochromic devices can be thermally in situ cured in an oven at a temperature, for example, of 60° C. or higher for a time period of, for example, five minutes or longer with the particular oven temperature and oven dwell time being readily established by experimentation for any given electrochromic monomer composition. For example, we find good results by exposure of the tin catalyzed compositions of the Examples to about 80° C. in an oven for about two hours. If faster curing systems are desired, then the monomer composition can be appropriately adjusted, particularly by appropriate selection of the type and concentration of initiators, curing agents, catalysts, cross-linking agents, accelerants, etc.

The required amount of energy may be delivered by exposing the electrochromic monomer composition to a less powerful source of electromagnetic radiation for a longer period of time, through for example multiple passes, or conversely, by exposing it to a more powerful source of electromagnetic radiation for a shorter period of time. In addition, each of those multiple passes may occur with a source at different energy intensities. In any event, those of ordinary skill in the art should choose an appropriate source of electromagnetic radiation depending on the particular electrochromic monomer composition, and place that source at a suitable distance therefrom which, together with the

length of exposure, optimizes the transformation process. Generally, a slower, controlled cure, such as that achieved by multiple passes using a less intense energy source, may be preferable over a rapid cure using a more intense energy source, for example, to minimize shrinkage during the transformation process. Also, it is desirable to use a source of electromagnetic radiation that is delivered in an intermittent fashion, such as by pulsing or strobing, so as to ensure a thorough and complete cure without causing excessive heat build-up.

In transforming electrochromic monomer compositions into polychromic solid films, shrinkage may be observed during and after the transformation process of the electrochromic monomer composition into a polychromic solid film. This undesirable event may be controlled or lessened to a large extent by making appropriate choices among the components of the electrochromic monomer composition. For instance, appropriately chosen polyfunctional monomers or cross-linking agents may enhance resistance to shrinkage during the transformation process. In addition, a conscious control of the type and amount of plasticizer used in the electrochromic monomer composition may also tend to enhance resistance to shrinkage. While shrinkage may also be observed with polychromic solid films that have been subjected to environmental conditions, especially conditions of environmental accelerated aging, such as thermal cycling and low temperature soak, a conscious choice of components used in the electrochromic monomer composition may tend to minimize this event as well. In general, shrinkage may be decreased as the molecular weight of the monomer employed is increased, and by using index matched inert fillers, such as glass beads or fibres.

Electrochromic devices may be manufactured with polychromic solid films of a particular thickness by preparing partially-cured polychromic solid films between the glass substrates of electrochromic assemblies with spacers or a thermoplastic spacing means having been placed on one or both of the substrates. This partially-cured polychromic solid film should have a thickness slightly greater than that which the resulting polychromic solid film will desirably assume in the completed device. The electrochromic assemblies should then be subjected to compression, such as that provided by an autoclave/vacuum bagging process, and thereafter be exposed to electromagnetic radiation to complete the transformation into a polychromic solid film with the desired film thickness.

FIGS. 1 and 2 show an electrochromic device assembled from the polychromic solid films of the present invention. The electrochromic assembly 1 includes two substantially planar substrates 2, 3 positioned substantially parallel to one another. It is preferable that these substrates 2, 3 be positioned as close to parallel to one another as possible so as to avoid double imaging, which is particularly noticeable in mirrors, especially when the electrochromic media—i.e., the polychromic solid film—is colored to a dimmed state.

A source of an applied potential need be introduced to the electrochromic assembly 1 so that polychromic solid film 6 may color in a rapid, intense and uniform manner. That source may be connected by electrical leads 8 to conducting strips, such as bus bars 7. The bus bars 7 may be constructed of a metal, such as copper, stainless steel, aluminum or solder, or of conductive frits and epoxides, and should be affixed to a conductive coating 4, coated on a surface of each of the substrates 2, 3. An exposed portion of the conductive coating 4 should be provided for the bus bars 7 to adhere by the displacement of the coated substrates 2, 3 in opposite directions relative to each other—lateral from, but parallel

to—, with polychromic solid film 6 positioned between, and in abutting relationship with, the conductive surface of the two substrates.

As noted above, coated on a surface of each of these substrates 2, 3 is a substantially transparent conductive coating 4. The conductive coating 4 is generally from about 300 Å to about 10,000 Å in thickness, having a refractive index in the range of about 1.6 to about 2.2. Preferably, a conductive coating 4 with a thickness of about 1,200 Å to about 2,300 Å, having a refractive index of about 1.7 to about 1.9, is chosen depending on the desired appearance of the substrate when the polychromic solid film situated therebetween is colored.

The conductive coating 4 should also be highly and uniformly conductive in each direction to provide a substantially uniform response as to film coloring once a potential is applied. The sheet resistance of these transparent conductive substrates 2, 3 may be below about 100 ohms per square, with about 6 ohms per square to about 20 ohms per square being preferred. Such substrates 2, 3 may be selected from among those commercially available as glass substrates, coated with indium tin oxide ("ITO") from Donnelly Corporation, Holland, Mich., or tin oxide-coated glass substrates sold by the LOF Glass division of Libbey-Owens-Ford Co., Toledo, Ohio under the tradename of "TEC-Glass" products, such as "TEC 10" (10 ohms per square sheet resistance), "TEC 12" (12 ohms per square sheet resistance), "TEC 15" (15 ohms per square sheet resistance) and "TEC 20" (20 ohms per square sheet resistance) tin oxide-coated glass. Moreover, tin oxide coated glass substrates, commercially available from Pittsburgh Plate Glass Industries, Pittsburgh, Pa. under the "SUNGATE" tradename, may be advantageously employed herein. Also, substantially transparent conductive coated flexible substrates, such as ITO deposited onto substantially clear or tinted "MYLAR", may be used. Such flexible substrates are commercially available from Southwall Corp., Palo Alto, Calif.

The conductive coating 4 coated on each of the substrates 2, 3 may be constructed from the same material or different materials, including tin oxide, ITO, ITO-FW, ITO-HW, ITO-HWG, doped tin oxide, such as antimony-doped tin oxide and fluorine-doped tin oxide, doped zinc oxide, such as antimony-doped zinc oxide and aluminum-doped zinc oxide, with ITO being preferred.

The substantially transparent conductive coated substrates 2, 3 may be of the full-wave length-type ("FW") (about 6 ohms per square to about 8 ohms per square sheet resistance), the half-wave length-type ("HW") (about 12 ohms per square to about 15 ohms per square sheet resistance) or the half-wave length green-type ("HWG") (about 12 ohms per square to about 15 ohms per square sheet resistance). The thickness of FW is about 3,000 Å in thickness, HW is about 1,500 Å in thickness and HWG is about 1,960 Å in thickness, bearing in mind that these substantially transparent conductive coated substrates 2, 3 may vary as much as about 100 to about 200 Å. HWG has a refractive index of about 1.7 to about 1.8, and has an optical thickness of about five-eighths wave to about two-thirds wave. HWG is generally chosen for electrochromic devices, especially reflective devices, such as mirrors, whose desired appearance has a greenish hue in color when a potential is applied.

Optionally, and for some applications desirably, the spaced-apart substantially transparent conductive coated substrates 2, 3 may have a weather barrier 5 placed therebetween or therearound. The use of a weather barrier 5 in

the electrochromic devices of the present invention is for the purpose of preventing environmental contaminants from entering the device during long-term use under harsh environmental conditions rather than to prevent escape of electrochromic media, such as with an electrochromic device. Weather barrier 5 may be made from many known materials, with epoxy resins coupled with spacers, plasticized polyvinyl butyral (available commercially under the "SAFLEX" tradename from Monsanto Co., St. Louis, Mo.), ionomer resins (available commercially under the "SURLYN" tradename from E. I. du Pont de Nemours and Co., Wilmington, Del.) and "KAPTON" high temperature polyamide tape (available commercially from E. I. du Pont de Nemours and Co., Wilmington, Del.) being preferred. In general, it may be desirable to use within the electrochromic device, and particularly for weather barrier 5, materials such as nitrile containing polymers and butyl rubbers that form a good barrier against oxygen permeation from environmental exposure.

A further recitation of weather barrier materials and types (including single and double weather barrier constructions) is found in copending U.S. patent application Ser. No. 08/429,643 filed Apr. 27, 1995, the disclosure of which is hereby incorporated by reference herein, including flexible weather barrier materials that are beneficial when the polychromatic solid film devices of this invention are exposed to wide and rapid oscillation between temperature extremes, such as the thermal shocks experienced during normal use in or on a vehicle in regions of climate extremes. Also, devices, such as electrochromic rearview mirrors utilizing a polychromatic solid film, can be constructed suitable for use on automobiles, and suitable to withstand accelerated aging testing such as boiling in water for an extended period (such as 96 hours or longer); exposure to high temperature/high humidity for an extended period (for example, 85° C./85% relative humidity for 720 hours or longer); exposure within a steam autoclave for extended periods (for example, 121° C.; 15-18 psi steam for 144 hours or longer).

In the sandwich lamination technique, see supra, it is the thickness of the polychromatic solid film itself, especially when a highly viscous electrochromic monomer composition is used, optionally coupled with either spacers or a thermoplastic spacing means, assembled within the electrochromic devices of the present invention that determines the interpane distance of the spaced-apart relationship at which the substrates are positioned. This interpane distance may be influenced by the addition of spacers to the electrochromic monomer composition, which spacers, when added to an electrochromic monomer composition, assist in defining the film thickness of the resulting polychromatic solid film. And, the thickness of the polychromatic solid film may be about 10 μm to about 1000 μm , with about 20 μm to about 200 μm being preferred, a film thickness of about 37 μm to about 74 μm being particularly preferred, and a film thickness of about 53 μm being most preferred depending of course on the chosen electrochromic monomer composition and the intended application.

By taking appropriate measures, electrochromic devices manufactured with polychromatic solid films may operate so that, upon application of a potential thereto, only selected portions of the device—i.e., through the polychromatic solid film—will color in preference to the remaining portions of the device. In such segmented electrochromic devices, lines may be scored or etched onto the conductive surface of either one or both of substrates 2, 3, in linear alignment so as to cause a break in electrical continuity between regions immediately adjacent to the break, by means such as chemi-

cal etching, mechanical scribing, laser etching, sand blasting and other equivalent means. By so doing, an addressable pixel may be created by the break of electrical continuity when a potential is applied to a pre-determined portion of the electrochromic device. The electrochromic device colors in only that predetermined portion demonstrating utility, for example, as an electrochromic mirror, where only a selected portion of the mirror advantageously colors to assist in reducing locally reflected glare or as an electrochromic information display device.

To prepare an electrochromic device containing a polychromatic solid film, the electrochromic monomer composition may be dispensed onto the conductive surface of one of the substrates 2 or 3. The conductive surface of the other substrate may then be placed thereover so that the electrochromic monomer composition is dispersed uniformly onto and between the conductive surface of substrates 2, 3.

This assembly may then be exposed, either in a continuous or intermittent manner, to electromagnetic radiation, such as ultraviolet radiation in the region between about 200 nm to about 400 nm for a period of about 2 seconds to about 10 seconds, so that the electrochromic monomer composition is transformed by in situ curing into polychromatic solid film 6. The intermittent manner may include multiple exposures to such energy.

Once the electrochromic device is assembled with polychromatic solid film 6, a potential may be applied to the bus bars 7 in order to induce film coloring. The applied potential may be supplied from a variety of sources including, but not limited to, any source of alternating current ("AC") or direct current ("DC") known in the art, provided that, if an AC source is chosen, control elements, such as diodes, should be placed between the source and each of the conductive coatings 4 to ensure that the potential difference between the conductive coatings 4 does not change polarity with variations in polarity of the applied potential from the source. Suitable DC sources are storage batteries, solar thermal cells, photovoltaic cells or photoelectrochemical cells.

An electrochromic device, such as an electrochromic shade band where a gradient opacity panel may be constructed by positioning the bus bars 7 along the edges of the substrates in such a way so that only a portion—e.g., the same portion—of each of the substrates 2, 3 have the bus bars 7 affixed thereto. Thus, where the bus bars 7 are aligned with one another on opposite substrates 2, 3, the introduction of an applied potential to the electrochromic device will cause intense color to be observed in only that region of the device onto which an electric field has been created—i.e., only that region of the device having the bus bars 7 so aligned. A portion of the remaining bleached region will also exhibit color extending from the intensely colored region at the bus bar/non-bus bar transition gradually dissipating into the remaining bleached region of the device.

The applied potential generated from any of these sources may be introduced to the polychromatic solid film of the electrochromic device in the range of about 0.001 volts to about 5.0 volts. Typically, however, a potential of about 0.2 volts to about 2.0 volts is preferred, with about 1 volt to about 1.5 volts particularly preferred, to permit the current to flow across and color the polychromatic solid film 6 so as to lessen the amount of light transmitted therethrough. The extent of coloring—i.e., high transmittance, low transmittance and intermediate transmittance levels—at steady state in a particular device will often depend on the potential difference between the conductive surface of the substrates 2, 3, which relationship permits the electrochromic devices of the present invention to be used as "gray-scale" devices, as that term is used by those of ordinary skill in the art.

A zero potential or a potential of negative polarity (i.e., a bleaching potential) may be applied to the bus bars 7 in order to induce high light transmittance through polychromic solid film 6. A zero potential to about -0.2 volts will typically provide an acceptable response time for bleaching; nevertheless, increasing the magnitude of the negative potential to about -0.7 volts will often enhance response times. And, a further increase in the magnitude of that potential to about -0.8 volts to about -0.9 volts, or a magnitude of even more negative polarity as the art-skilled should readily appreciate, may permit polychromic solid film 6 to form a light-colored tint while colored to a partial- or fully-dimmed state.

In electrochromic devices where the polychromic solid film is formed within the assembly by exposure to electromagnetic radiation, the performance of the device may be enhanced by applying the positive polarity of the potential to the substrate that faced the electromagnetic radiation during the transformation process. Thus, in the case of electrochromic mirrors manufactured in such a manner, the positive polarity of the potential should be applied to the conductive surface of the clear, front glass substrate, and the negative polarity of the potential applied to the conductive surface of the silvered, rear glass substrate, to observe such a beneficial effect.

In the context of an electrochromic mirror assembly, a reflective coating, having a thickness in the range of 250 Å to about 2,000 Å, preferably about 1,000 Å, should thereafter be applied to one of the transparent conductive coated glass substrates 2 or 3 in order to form a mirror. Suitable materials for this layer are aluminum, palladium, platinum, titanium, gold, chromium, silver and stainless steel, with silver being preferred. As an alternative to such metal reflectors, multi-coated thin film stacks of dielectric materials or a high index single dielectric thin film coating may be used as a reflector. Alternatively, one of the conductive coatings 4 may be a metallic reflective layer which serves not only as an electrode, but also as a mirror.

It is clear from the teaching herein that should a window, sun roof or the like be desirably constructed, the reflective coating need only be omitted from the assembly so that the light which is transmitted through the transparent panel is not further assisted in reflecting back therethrough.

Similarly, an electrochromic optically attenuating contrast filter may be manufactured in the manner described above, optionally incorporating into the electrochromic assembly an anti-reflective means, such as a coating, on the front surface of the outermost substrate as viewed by an observer (see e.g., Lynam V); an anti-static means, such as a conductive coating, particularly a transparent conductive coating of ITO, tin oxide and the like; index matching means to reduce internal and interfacial reflections, such as thin films of an appropriately selected optical path length; and/or lightneutrobing glass, such as glass tinted to a neutral density, such as "GRAYLITE" gray tinted glass (commercially available from Pittsburgh Plate Glass Industries, Pittsburgh, Pa.) and "SUNGLAS" Gray gray tinted glass (commercially available from Ford Glass Co., Detroit, Mich.), to augment contrast enhancement. Moreover, polymer interlayers, which may be tinted gray, such as those used in electrochromic constructions as described in Lynam III, may be incorporated into such electrochromic optically attenuating contrast filters.

Electrochromic optical attenuating contrast filters may be an integral part of a device or may be affixed to an already constructed device, such as cathode ray tube monitors. For instance, an optical attenuating contrast filter may be manu-

factured from a polychromic solid film and then affixed, using a suitable optical adhesive, to a device that should benefit from the properties and characteristics exhibited by the polychromic solid film. Such optical adhesives maximize optical quality and optical matching, and minimize interfacial reflection, and include plasticized polyvinyl butyral, various silicones, polyurethanes such as "NORLAND NOA 65" and "NORLAND NOA 68", and acrylics such as "DYMAX LIGHT-WELD 478". In such contrast filters, the electrochromic compounds are chosen for use in the polychromic solid film so that the electrochromic assembly may color to a suitable level upon the introduction of an applied potential thereto, and no undesirable spectral bias is exhibited. Preferably, the polychromic solid film should dim through a substantially neutral colored partial transmission state to a substantially neutral colored full transmission state.

Polychromic solid films may be used in electrochromic devices, particularly glazings and mirrors, whose functional surface is substantially planar or flat, or that are curved with a convex curvature, a compound curvature, a multi-radius curvature, a spherical curvature, an aspheric curvature, or combinations of such curvature. For example, flat electrochromic automotive mirrors may be manufactured using the polychromic solid films of the present invention. Also, convex electrochromic automotive mirrors may be manufactured, with radii of curvature typically in the range of about 25" to about 250", preferably in the range of about 35" to about 100", as are conventionally known. In addition, multi-radius automotive mirrors, such as those described in U.S. Pat. No. 4,449,786 (McCord), may be manufactured using the polychromic solid films of the present invention. Multi-radius automotive mirrors may be used typically on the driver-side exterior of an automobile to extend the driver's field of view and to enable the driver to safely see rearward and to avoid blind-spots in the rearward field of view. Generally, such mirrors comprise a higher radius (even flat) region closer to the driver and a lower radius (i.e., more curved) region outboard from the driver that serves principally as the blind-spot detection zone in the mirror.

Indeed, such polychromic solid film-containing electrochromic multi-radius automotive mirrors may benefit from the prolonged coloration performance of polychromic solid films and/or from the ability to address individual segments in such mirrors.

Often, a demarcation means, such as a silk-screened or otherwise applied line of black epoxy, may be used to separate the more curved, outboard blind-spot region from the less curved, inboard region of such mirrors. The demarcation means may also include an etching of a deletion line or an otherwise established break in the electrical continuity of the transparent conductors used in such mirrors so that either one or both regions may be individually or mutually addressed. Optionally, this deletion line may itself be colored black. Thus, the outboard, more curved region may operate independently from the inboard, less curved region to provide an electrochromic mirror that operates in a segmented arrangement. Upon the introduction of an applied potential, either of such regions may color to a dimmed intermediate reflectance level, independent of the other region, or, if desired, both regions may operate together in tandem.

An insulating demarcation means, such as demarcation lines, dots and/or spots, may be placed within electrochromic devices, such as mirrors, glazings, optically attenuating contrast filters and the like, to assist in creating the interpane distance of the device and to enhance overall performance.

in particular the uniformity of coloration across large area devices. Such insulating demarcation means, constructed from, for example, epoxy coupled with glass spacer beads, plastic tape or die cut from plastic tape, may be placed onto the conductive surface of one or more substrates by silk-screening or other suitable technique prior to assembling the device. The insulating demarcation means may be geometrically positioned across the panel, such as in a series of parallel, uniformly spaced-apart lines, and may be clear, opaque, tinted or colorless and appropriate combinations thereof, so as to appeal to the automotive stylist.

If the interpane distance between the substrates is to be, for ample, about 250 μm , then the insulating demarcation means (being substantially non-deformable) may be screened, acted or adhered to the conductive surface of a substrate at a lesser thickness, for example, about 150 μm to about 225 μm . Of course, if substantially deformable materials are used as such demarcation means, a greater thickness, for example, about 275 μm to about 325 μm , may be appropriate as well. Alternatively, the insulating demarcation means may have a thickness about equal to that of the interpane distance of the device, and actually assist in bonding together the two substrates of the device.

In any event, the insulating demarcation means should prevent the conductive surfaces of the two substrates (facing one another in the assembled device) from contacting locally one another to avoid short-circuiting the electrochromic system. Similarly, should the electrochromic device be touched, pushed, impacted and the like at some position, the insulating demarcation means, present within the interpane distance between the substrates, should prevent one of the conductive surfaces from touching, and thereby short-circuiting, the other conductive surface. This may be particularly advantageous when flexible substrates, such as ITO-coated "MYLAR", are used in the electrochromic device.

Although spacers may be added to the electrochromic monomer composition and/or distributed across the conductive surface of one of the substrates prior to assembling the device, such random distribution provides a degree of uncertainty as to their ultimate location within the electrochromic device. By using such a screen-on technique as described above, a more defined and predictable layout of the insulating demarcation means may be achieved. Further, such spacers may be a rigid insoluble spacer material such as glass or be rigid soluble spacer material (such as a polymer such as polycarbonate, polymethylmethacrylate, polystyrene and the like) capable of dissolving in the plasticizer of the monomer composition. For example, rigid, soluble polymer spacer beads can be sprinkled across the conductive surface of a substrate and so help define an interpane spacing when the device is first assembled. Then, when the monomer composition is dispensed into the interpane spacing (after the establishment of the interpane spacing with the assistance of soluble polymer spacers), then over time the soluble spacer beads dissolve in the plasticizer, preferably prior to in situ conversion to the solid polychromic film.

Using such insulating demarcation means, one or both of the substrates, either prior to or after assembly in the device, may be divided into separate regions with openings or voids within the insulating demarcation means interconnecting adjacent regions so as to permit a ready introduction of the electrochromic monomer composition into the assembly.

A demarcation means may be used that is conductive as well, provided that it is of a smaller thickness than the interpane distance and/or a layer of an insulating material, such as a non-conductive epoxy, urethane or acrylic, is

applied thereover so as to prevent conductive surfaces from contacting one another and thus short-circuiting the electrochromic assembly.

Such conductive demarcation means include conductive frits, such as silver frits like the # 7713 silver conductive frit available commercially from E. I. de Pont de Nemours and Co., Wilmington, Del., conductive paint or ink and/or metal films, such as those disclosed in Lynam IV. Use of a conductive demarcation means, such as a line of the # 7713 silver conductive frit, having a width of about 0.09375" and a thickness of about 50 μm , placed on the conductive surface of one of the substrates of the electrochromic device may provide the added benefit of enhancing electrochromic performance by reducing bus bar-to-bus bar overall resistance and thus enhancing uniformity of coloration, as well as rapidity of response, particularly over large area devices.

Fabrication of electrochromic multi-radius/aspheric or spherical/convex mirrors can benefit from single or tandem bending such as is described in copending U.S. patent application Ser. No. 08/429,643, the disclosure of which is hereby incorporated by reference herein. Convex or multi-radius minilites/shapes can, for example, be individually bent [and thereafter ITO coated or metal reflector coated (such as with a chromium metal reflector, a chromium undercoat, rhodium overcoat metal reflector, a chromium undercoat/aluminum overcoat reflector, or their like, such as is described in U.S. patent application Ser. No. 08/429,643 and then the individual bent minilites/shapes can be selectively sorted so that the best matched pairs from a production batch can be selected. For example, bent convex or aspheric minilites/shapes can be bent in production lots such as of 100 pieces or thereabouts. Thereafter, each individual bent minilite/shape is placed in a vision system where the reflection of a pattern of dots, squares, lines, circles, ovals (or the like) is photographed using a digital camera and the position of individual dots, etc. in the pattern, as reflected off the individual minilite/shape being measured, is captured and stored digitally in a computer storage. Each individual minilite/shape, in turn, is similarly measured and a digital image of the reflected image of each part's pattern is also computer stored. An identifier is allocated to each minilite/shape and to its corresponding computer stored record of the reflected image of the pattern. Next, a computer program finds which combination of two minilites/shapes have most closely matched reflected images of the fixed pattern (which typically is a dot matrix or the like). This is achieved, for example, by finding how close the center of one reflected dot on a given part is located apart from its corresponding dot on another part. For perfectly matched parts, corresponding dots coincide; when they are located apart, then a local mismatch is occurring. Thus, by using a dot matrix of, for example, 10 to 100 dots reflected off a given part, and forming the sum of the squares of the absolute interdot distances to give a figure of merit for each putative from match, then minilites/shapes can be selectively sorted by selecting the matched pairs with the lowest inter-dot distances as indicated by the smallest figure of merit. Alternately, a pattern with a measured, pre-established distortion can be designed such that, upon reflection off the convex (or concave) surface of a bent minilite/shape, the pattern is reflected as straight, parallel lines. The equipment suitable to use in a vision system is conventional in the machine vision art and includes a digital camera (such as a charge coupled device (CCD) camera or a video microchip camera (CMOS camera)), a frame grabber/video computer interface, and a computer. Typically the camera is mounted above (typically 1 foot to 4 feet above, or even farther

above) the subject minilite/shape, and the camera views through the pattern (that typically is an illuminated light box with the pattern incorporated therein) to view the pattern's reflection off the convex (or, if desired, the concave) surface of the bent part. If desired, optical calculations can be made that allow determination of the actual profile of the bent glass based upon measurements taken and calculated from the pattern's reflection.

Also, an aspheric electrochromic (or a convex electrochromic) mirror can be used as an interior rearview mirror, and can be packaged as a clip-on to an existing vehicular rearview mirror in a manner that is similar to aftermarket wide angle mirrors conventionally known. Such interior aspheric/convex electrochromic mirrors can optionally be solar powered or be powered by a battery pack, for ease of installation in the vehicular aftermarket. Should it be desirable to minimize weight for convex or aspheric inside or outside mirrors, then thin glass (in the thickness range of about 1 mm to about 1.8 mm, or even thinner) can be used for one or both of the substrates used in a laminate electrochromic assembly. Use of such thin glass is described in copending U.S. patent application Ser. No. 08/429,643 filed Apr. 27, 1995, the disclosure of which is hereby incorporated by reference herein. Also, cutting of convex and especially aspheric glass can benefit from computer numerical controlled (CNC) cutting where a cutting head is moved under digital computer control. In this regard, a multi-axis CNC cutter is preferred where the cutting head (which may be a diamond tool or wheel, a laser beam, a water jet, an abrasive water jet, or the like) can be moved in three dimensions. Most preferably, and especially for cutting aspheric bent glass, a cutter that moves in three-dimensions but that keeps the cutting tool (such as a diamond wheel) normal (i.e., with a cutting wheel axis at or close to 90° to the tangential plane of the bent glass surface) is preferred. For example, a cutting machine such as available from LASER Maschinenbau GmbH & Company KG, Grossbettingen, Germany can be used to cut aspheric glass. In such a system, the bent glass lite/minilite from which the shape is to be cut is mounted on a support arm that is movable in three dimensions and that generally moves in three dimensions either CNC driven, or by following a cam, along the three-dimensional profile of the aspheric shape being cut. Also, the cutting wheel can be adjusted so that its angle relative to a tangent to the glass at point of cut is close to 90° (and not less than about 70°; not less than about 80° more preferred and not less than about 85° most preferred). In this manner, movement of the cutting support under the cutting wheel, in combination with adjustment of the pitch of the cutting wheel itself, maintains as close to normal (i.e., 90°) the cutting angle as possible, and thus achievement of a clean, efficient cut and breakout of the shape. While particularly beneficial for aspheric shapes where the radius can change from about 2000 mm to below 600 mm, and smaller, across the surface of the shape, cutting of convex glass can also benefit from maintenance of a near normal cutting angle for the cutting tool (i.e., cutting wheel).

Optionally, a machine vision system can be utilized to determine the surface profile of the glass to be cut and the data as to the profile is fed back to the cutter's CNC controller to properly orientate the glass under the cutting head. Use of a vision system, such as is described above, to scan and measure the system profile of the glass to be cut can be thus used to determine how much offset there is on the radius of the glass relative to the cutting head. CNC controlled sensors can be automatically adjusted on every cutting cycle based on the information received from the

vision system. A five-axis shape cutter that allows the cutting head remain approximately perpendicular to the surface of the glass regardless of the radius of curvature is commercially available, such as from LASER Maschinenbau GmbH & Company KG, Grossbettingen, Germany. Also, if desired and particularly for thin glass substrates, the front substrate and/or rear substrate can be toughened or tempered (such as by, for example, chemical tempering or contact tempering) such as described in U.S. Pat. No. 5,239,405 entitled "Near-Infrared Reflecting, Ultraviolet Protected, Safety Protected Vehicular Glazing" invented by N. Lynam and issued Aug. 24, 1993, the disclosure of which is hereby incorporated by reference herein. Also, an exterior mirror of this invention can be attached to the backplate commonly used to mount to the actuator used in an exterior complete mirror assembly (as is commonly known in automotive mirror art) by use of a double-sticky tape such as is described in U.S. Pat. No. 5,572,384 (see supra) or can be attached using a hot melt adhesive that is applied to the rearmost surface of the laminate glass assembly (i.e., the rear surface of the rear glass substrate, often referred to as the fourth surface of the laminate assembly). Preferably, such hot melt adhesive, when cured, is flexible, provides an anti-scatter function meeting automotive safety specification and most preferably, is electrically conductive (such as by inclusion of conductive carbon or conductive metal flakes or fibrils, such as copper, brass, aluminum or steel fibrils). Also, a heater can be attached to the rearmost surface of the laminate construction formed by sandwiching the electrochromic medium between the first and second (i.e., front and rear) substrates of an electrochromic rearview mirror device. Such heater can be directly applied to the rearmost glass surface, or can be a separate heater pad, such as is disclosed in copending U.S. patent application Ser. No. 08/429,643 filed Apr. 27, 1995, the disclosure of which is hereby incorporated by reference herein. Preferably, the heater is combined with the mirror reflector mounting plate (also known in the automotive mirror art as the mirror backing plate or the mirror backplate). More preferably, the heater and/or the mirror backing plate is formed (such as by injection molding, extrusion and the like) of a conductive polymer material such as a polymer resin incorporating conductive carbon or conductive metal flakes or fibrils (such as of copper, brass, aluminum, steel or equivalent metal). Most preferably, the heater and the mirror backing plate are formed and attached to the mirror element in an integral molding operation as follows. The mirror reflector glass (that preferably is an electrochromic mirror cell but that, optionally, can be a conventional mirror reflector such as chromed glass) is placed in a mold. A heater (such as a positive temperature coefficient heater pad, or a pad formed from a conductive polymer resin that incorporates metal or carbon conducting particles, or a pad formed from a resin that is intrinsically self-conducting in its resin structure such as a polyaniline resin), is either injection molded onto the rearmost glass surface of the glass reflector element (optionally, with an adhesion promoting primer already applied to the rearmost glass surface and/or with a heat transfer agent applied to the rearmost glass surface), or is attached to the rearmost glass surface (or is already pre-attached to the rearmost glass surface) using a double-sticky tape or a hot melt adhesive (preferably, also conducting and/or of high heat transfer efficiency such as aluminum foil). Finally, a plastic resin is injection molded to form the mirror backing plate (and, optionally, the bezel around the outer perimeter of an electrochromic sideview mirror sub-assembly as is commonly known in the electrochromic

rearview mirror art). The backing plate for the mirror element is the means for attachment to the electrical or manually operated actuator within the complete outside sideview mirror assembly that enables the driver to change the orientation of the mirror reflector when mounted on the vehicle and to select the mirror's alignment relative to the driver and thus select the rearward view that suits that particular driver's needs for field of view rearward. By integral molding, the conventionally separate steps of separately attaching a heater pad to the mirror glass and then attaching a separately formed backing plate can be reduced to a single integral molding step where components, including the mirror glass, are loaded into a mold, plastic resin is injected or plastic resins are co-injected, and a complete sub-assembly (including heater, connectors, busbars, wire leads/wire harnesses, heat distributors, thermistors, thermal cut-off switches, backing plate, bezel, etc.) is unloaded from the tool after completion of the integral molding step.

Further, vehicle warning indicia such as the familiar "OBJECTS MAY BE CLOSER THAN THEY APPEAR" can be created (such as by silk-screening, dispensing, printing, etc.) using a conductive material (such as a conductive ink, conductive paint, conductive polymer and the like). In this way, electrical conductivity is maintained across the full surface of the inward facing surface of the rear substrate (frequently called the third surface). Where a metal reflector (such as a chromium layer or an underlayer of chromium overcoated with a higher reflecting metal layer such as of silver, aluminum or rhodium) is used as a third surface reflector, the metal reflector can first be deposited (such as by sputter deposition utilizing planar magnetron or rotary magnetron cathodes) onto the conductive surface of TEC glass (or any other transparent conductive coated surface). Next, the metal reflector can be selectively removed to form the desired indicia (i.e., a "HEATED" symbol, a manufacturer's date code and ID, a hazard warning indicia such is commonly found on signal mirrors such as are available on MY97 Ford Bronco and Ford Expedition vehicles available from Ford Motor Company, Detroit, Mich. and as described in U.S. Pat. No. 5,207,492 invented by Roberts and issued May 1993, the disclosure of which is hereby incorporated by reference herein). The metal reflector can be removed using chemical etching through a mask or directly using laser scribing (such as with a YAG laser), by controlled sandblasting, and the like. By selectively removing the overlayering metal reflector but leaving the underlying transparent conductor largely intact, electrical conductivity across the third surface (i.e., the inward facing surface of the rear substrate) is largely undistributed, and electrochromic coloration is correspondingly uniform. Should it be desired to read an indicia on a third surface, then backlighting can be provided on the fourth surface (i.e., the non-inward facing surface of the rear substrate) that can be viewed by reading through the indicia created on the third surface by removing a third surface metal reflector. Also, optionally, a conductive indicia of a non-dark color (such as brilliant white) could be created on the second surface (i.e., the inward facing surface of the front substrate) of the laminate electrochromic assembly. Thus, when the electrochromic medium colors, the indicia remains visible as a color contrast against the colored dimmed state of the electrochromic medium. Preferably, and as stated above, the indicia is created from conducting or at least partially conducting material (such as can be achieved using conductive carbon fillers). Alternately, non-conducting non-dark colored indicia can be used on the second surface of the laminate assembly. Preferably, such non-dark colored indi-

cia are bright and somewhat reflecting so that they maintain good color contrast in the dimmed state of the electrochromic mirror.

Once constructed, any of the electrochromic devices described herein may have a molded casing placed there around. This molded casing may be pre-formed and then placed about the periphery of the assembly or, for that matter, injection molded therearound using conventional techniques, including injection molding of thermoplastic materials, such as polyvinyl chloride [see e.g., U.S. Pat. No. 4,139,234 (Morgan)], or reaction injection molding of thermosetting materials, such as polyurethane or other thermosets [see e.g., U.S. Pat. No. 4,561,625 (Weaver)]. Thus, modular automotive glazings incorporating polychromic solid films may be manufactured.

Polychromic solid films may be used in a variety of automotive rearview mirror assemblies including those assemblies described in U.S. patent application Ser. No. (not yet assigned) entitled "Vehicle Blind Spot detection and Display System", invented by Schofield et al. and filed Feb. 12, 1997, the disclosure of which is hereby incorporated herein by reference. Also, they may be used in association with rain sensor interior mirror assemblies wherein a rain sensor functionality, as is commonly known in the automotive art, is provided in association with an interior rearview mirror assembly. Such association includes utilizing an element of the rearview mirror assembly (such as a plastic housing attached, for example, to the mirror channel mount that conventionally attaches the mirror assembly to a windshield button slug) to cover a windshield-contacting rain sensor (such as is described in U.S. Pat. No. 4,973,844 titled "Vehicular Moisture Sensor and Mounting Apparatus Therefor", invented by O'Farrell et al. and issued Nov. 27, 1990, the disclosure of which is hereby incorporated herein by reference), or it may include a non-windshield-contacting rain sensor (such as is described in PCT International Application PCT/US94/05093 entitled "Multi-Function Light Sensor for Vehicle" invented by Dennis J. Hegyl, published as WO 94/27262 on Nov. 24, 1994, the disclosure of which is hereby incorporated by reference herein). The rearview mirror assembly can include a display function (or multiple display functions).

These displays may perform a single display function or multiple display functions such as providing indication of an additional vehicle function, such as a compass mirror display function, a temperature display function, status of inflation of tires display function, a passenger air bag disable display function, an automatic rain sensor operation display function, telephone dial information display function, highway status information display function, blind spot indicator display function, or the like. Such display may be an alpha-numerical display or a multi-pixel display, and maybe fixed or scrolling. Such an automatic rain sensor operation display function may include a display function related to both a windshield-contacting and a non-windshield-contacting rain sensor, including, for example, where the circuitry to control the rain sensor, electrochromic dimming of a variable reflectance electrochromic mirror, and any other mirror-mounted electronic feature are commonly housed in or on a rearview mirror assembly and wholly or partially share components on a common circuit board. The blind spot detection display or the automatic rain sensor operation display may alternate with other display functions by a display toggle which may be manually operated, time-shared, voice-actuated, or under the control of some other sensed function, such as a change in direction of the vehicle or the like. Should a rain sensor control be associated

with, incorporated in, or coupled to the interior rearview mirror assembly, the rain sensor circuitry, in addition to providing automatic or semi-automatic control over operation of the windshield wipers (on the front and/or rear windshield of the vehicle), can control the defogger function to defog condensed vapor on an inner cabin surface of a vehicle glazing (such as the inside surface of the front windshield, such as by operating a blower fan, heater function, air conditioning function, or their like), or the rain sensor control can close a sunroof or any other movable glazing should rain conditions be detected. As stated above, it may be advantageous for the rain sensor control (or any other feature such as a head-lamp controller, a remote keyless entry receiver, a cellular phone including its microphone, a vehicle status indicator and the like) to share components and circuitry with the electrochromic mirror function control circuitry and electrochromic mirror assembly itself. Also, a convenient way to mount a non-windshield-contacting rain sensor such as described by Hegyl is by attachment, such as by snap-on attachment, as a module to the mirror channel mount such as is described in U.S. Pat. No. 5,576,678 entitled "Mirror Support Bracket," invented by R. Hook et al. and issued Nov. 19, 1996, the disclosure of which is hereby incorporated by reference herein. The mirror mount and/or windshield button may optionally be specially adapted to accommodate a non-windshield-mounting rain sensor module. Such mounting as a module is readily serviceable and attachable to a wide variety of interior mirror assemblies (both electrochromic and non-electrochromic such as prismatic, manually adjusted mirror assemblies), and can help ensure appropriate alignment of the non-windshield-mounted variety of rain sensor to the vehicle windshield insofar that the module attached to the mirror mount remains fixed whereas the mirror itself (which typically attaches to the mirror channel mount via a single or double ball joint) is movable so that the driver can adjust its field of view. Also, should smoke from cigarettes and the like be a potential source of interference to the operation of the non-windshield-contacting rain sensor, then a mirror-attached housing can be used to shroud the rain sensor unit and shield it from smoke (and other debris). Optionally, such ability to detect presence of cigarette smoke can be used to enforce a non-smoking ban in vehicles, such as is commonly requested by rental car fleet operators. Also, when a rain sensor (contacting or non-contacting) is used to activate the wiper on the rear window (rear backlight) of the vehicle, the sensor can be conveniently packaged and mounted with the CHMSL (center high mounted stop light) stop light assembly commonly mounted on the rear window glass or close to it. Mounting of the rain sensor with the CHMSL stop light can be aesthetically appealing and allow sharing of components/wiring/circuitry.

The electrochromic solid films can be used with interior rearview mirrors equipped with a variety of features such as a high/low (or daylight running beam/low) headlamp controller, a hands-free phone attachment, a video camera for internal cabin surveillance and/or video telephone function, seat occupancy detection, map reading lights, compass/temperature display, fuel level and other vehicle status display, a trip computer, an intrusion detector and the like. Again, such features can share components and circuitry with the electrochromic mirror circuitry and assembly so that provision of these extra features is economical.

Placement of a video camera either at, within, or on the interior rearview mirror assembly (including within or on a module attached to a mirror structure such as the mount that

attaches to the windshield button) has numerous advantages. For example, the mirror is centrally and high mounted and so is in a location that has an excellent field of view of the driver, and of the interior cabin in general. Also, it is a defined distance from the driver and so focus of the camera is facilitated. Also, if placed on the movable portion of the mirror assembly, the normal alignment of the mirror reflector relative to the driver's field of vision rearward via the mirror can be used to readily align the video camera to view the head of the driver. Since many interior rearview mirrors are electrically serviced, placement of a camera at within, or on the rearview mirror assembly can be conveniently and economically realized, with common sharing of components and circuitry by, for example, a compass direction function (which may include a flux gate sensor, a magneto-resistive sensor, a magneto-inductive sensor, or a magneto-capacitive sensor), an external temperature display function and the electrochromic dimming function. Although the driver is likely the principal target and beneficiary of the video camera, the video camera field of view can be mechanically or electrically (i.e., via a joystick) adjusted to view other portions/occupants of the vehicle cabin interior. In this regard, the joystick controller that adjusts the position of the reflector on the outside rearview mirrors can, optionally, be used to adjust the video camera field of view as well. The video camera can be a CCD camera or a CMOS based video microchip such as is described in PCT Application NO. 94/01954 filed Feb 25, 1994, the disclosure of which is hereby incorporated by reference herein. For operation at night, the internal cabin of the vehicle may optionally be illuminated with non-visible radiation, such as near-infrared radiation, and the video camera can be responsive to said near-infrared radiation so that a video telephone call can be conducted even when the interior cabin is dark to visible light, such as at night. Also, the video camera mounted at, within or on the inner rearview mirror assembly (such as within the mirror housing or in a pod attached to the mirror mount) can be utilized to capture an image of the face of a potential driver and then, using appropriate image recognition software, decide whether the driver is authorized to operate the vehicle and, only then, enable the ignition system to allow the motor of the vehicle be started. Use of such a mirror-mounted video camera (or a digital still camera) enhances vehicle security and reduces theft. Further, the video camera can monitor the driver while he/she is driving and, by detection of head droop, eye closure, eye pupil change, or the like, determine whether the driver is becoming drowsy/falling asleep, and then activate a warning to the driver to stay alert/wake up. It is beneficial to use a microprocessor to control multiple functions within the interior mirror assembly and/or within other areas of the vehicle (such as the header console area), and such as is described in Irish Patent Application No. 970014 entitled "A Vehicle Rearview Mirror and A Vehicle Control System Incorporating Such Mirror," application date Jan. 9, 1997, the disclosure of which is hereby incorporated by reference herein. Such microprocessor can, for example, control the electrochromic dimming function, a compass direction display and an external temperature display. For example, a user actuatable switch can be provided that at one push turns on a compass/temperature display, on second push changes the temperature display to metric units (i.e., to degrees Celsius), on third push changes to Imperial units (i.e., degrees Fahrenheit) and on fourth push turns off the compass/temperature display, with the microprocessor controlling the logic of the display. Alternately, a single switch actuation turns on the display in Imperial units, the second

actuation changes it to metric units, and third actuation turns the display off. Further, the displays and functions described herein can find utility also on outside rearview mirrors. For example, a transducer that receives and/or transmits information to a component of an intelligent highway system (such as is known in the automotive art) can be incorporated into an interior and/or outside rearview mirror assembly. Thus, for example, a transmitter/receiver for automatic toll booth function could be mounted at/within/on an outside sideview mirror assembly. A digital display of the toll booth transaction can be displayed by a display incorporated in the interior rearview mirror assembly. Optionally, a micro printer incorporated within the rearview mirror can print a receipt of the transaction. Similarly, for safety and security of the highways, GPS information, state of traffic information, weather information, telephone number information, and the like may be displayed and transmitted/received via transducers located at, within, or on an interior rearview mirror assembly and/or an outside sideview mirror assembly. Also, the interior rearview mirror assembly can include a link to the Worldwide Web via the INTERNET. Such as via a modem/cellular phone mounted within the vehicle, and preferably, mounted at, within or on the interior rearview mirror assembly. Thus, the driver can interact with other road users, can receive/transmit messages including E-mail, can receive weather and status of highway traffic/conditions, and the like, via a mirror located interface to the INTERNET.

Further, a trainable garage door opener such as a universal garage door opener such as is available from Prince Corporation, Holland, Mich. under the tradename HOMELINK™, or the transmitter for a universal home access system that replaces the switch in a household garage that opens/closes the garage door with a smart switch that is programmable to a household specific code that is of the rolling code type, such as is available from TRW Automotive, Farmington Hills, Mich. under the tradename KWIKLINK™ may be mounted at, within, or on the interior mirror (or, if desired, the outside sideview mirror). Switches to operate such devices (typically up to three separate push type switches, each for a different garage door/security gate/household door) can be mounted on the mirror assembly, preferably user actuatable from the front face of the mirror housing. Preferably, the universal garage door opener HOMELINK™ unit or the universal home access KWIKLINK™ unit is mounted at, within or on the interior rearview mirror assembly. Optionally, such a unit could be mounted at, within or on an outside sideview mirror assembly.

The KWIKLINK™ Universal Home Access System (which operates on a rolling code, such as is commonly known in the home/vehicle security art) comprises a vehicle mounted transmitter and a receiver located in the garage. The KWIKLINK™ system is a low-current device that can be, optionally, operated off a battery source, such as a long life lithium battery. It is also compact and lightweight as executed on a single-or double-sided printed circuit board. The KWIKLINK™ printed circuit board can be mounted within the mirror housing (optionally adhered to a shock absorber comprising a double-sticky tape anti-scatter layer on the rear of the reflector element (prismatic or electrochromic) such as is described in U.S. Pat. No. 5,572,354 entitled "Rear Mirror Assembly", invented by J. Desmond et al. and issued Nov. 5, 1996, the disclosure of which is hereby incorporated by reference herein or may be accommodated within a detachable module, such as the pod described in U.S. Pat. No. 5,576,678 entitled "Mirror Sup-

port Bracket", invented by R. Hook et al. and issued Nov. 19, 1996, the disclosure of which is hereby incorporated by reference herein, and with the detachable module attached to the mirror mount or to the mirror button. Mounting the KWIKLINK™ unit in a detachable module has advantages, particularly for aftermarket supply where a battery operated KWIKLINK™ unit can be supplied within a pod housing (with the necessary user actuatable button or buttons mounted on the pod and with the battery being readily serviceable either by access through a trap door and/or by detaching the pod from the mirror mount). By supplying a battery-operated, stand-alone, snap-on, detachable KWIKLINK™ mirror mount pod, the KWIKLINK™ home access system can be readily and economically provided to a broad range of mirrors (including non-electrical mirrors such as base prismatic mirrors, and electrical mirrors such as lighted prismatic mirrors and electro-optic mirrors, such as electrochromic mirrors). Further, a solar panel can be installed on the pod housing to recharge the battery.

Also, the pod module assembly may have a windshield button mount attached thereto or incorporated therein and have, in addition, a structure that replicates the windshield button standard on most vehicles manufactured in the United States. Thus, when a consumer purchases such an aftermarket product, the consumer simply removes the existing interior rearview mirror assembly from the windshield button it is attached to in the vehicle. Then, the consumer attaches the pod module windshield button mount to the windshield button attached to the windshield (this can be achieved either by sliding on and securing with a screwdriver, or by snap-on in a manner conventional in the mirror mounting art). Finally, the consumer now attaches the rearview mirror assembly to the windshield button replication structure that is part of the aftermarket pod module. Since the windshield button shape is largely an industry standard (but the interior rearview mirror mount that attaches thereto is typically not standard), by using this "button on a button" pod module design, an aftermarket product (such as a pod module incorporating a home access transmitter, a universal garage door opener, a security monitor such as a pyroelectric intrusion detector (such as disclosed in copending U.S. patent application Ser. No. 08/720,237 filed Sep. 26, 1996, the disclosure of which is hereby incorporated by reference herein), a remote keyless entry receiver, a compass, a temperature and/or clock function and the like) may be readily installed by the vehicle owner, and the existing rearview mirror assembly can be readily remounted in the vehicle.

Also, a cellular phone can be incorporated into the interior mirror assembly with its antenna, optionally, incorporated into the outside sideview mirror assembly or into the inside rearview mirror assembly. Such mounting within the mirror assemblies has several advantages including that of largely hiding the cellular phone and antenna from ready view by a potential thief. Further, a seat occupancy detector coupled to an air bag deployment/disable monitor can be located at, within or on the interior rearview mirror assembly. The seat occupancy detector can be a video microchip or CCD camera seat occupancy detector, an ultrasonic detector or a pyroelectric detector, or their combination. Moreover, where more than one rearview mirror is being controlled or operated, or when several vehicle accessories are linked to, for example, an electrochromic interior or outside mirror, interconnections can be multiplexed, as is commonly known in the automotive art. Moreover, where it is desired to display external outdoor temperature within the interior cabin of the vehicle, a temperature sensor (such as a ther-

mocouple or thermistor) can be mounted at, within or on an outside sideview mirror assembly (for example, it can protrude into the slipstream below the lower portion of the sideview mirror housing in a manner that is aesthetically and styling acceptable to the automakers and to the consumer) and with the temperature sensor output connected, directly or by multiplexing to a display (such as a vacuum fluorescent display) located in the interior cabin of the vehicle.

Preferably, the external temperature display is located at, within or on the interior rearview mirror assembly, optionally in combination with another display function such as a compass display (see U.S. patent application Ser. No: not yet assigned, entitled "Vehicle Blind Spot Detection System" invented by K. Schofield et al., and filed Feb. 12, 1997), or as a stand-alone pod attached as a module to a mirror support member (see U.S. Pat. No. 5,576,687). Most preferably, the interior and outside mirror assemblies are supplied by the same supplier, using just-in-time sequencing methods, such as is commonly known in the automotive supply art and as is commonly used such as for supply of seats to vehicles. Just-in-time and/or sequencing techniques can be used to supply a specific option (for example, the option of configuring an external temperature display with a base prismatic interior mirror, or with a base electrochromic interior mirror, or with a compass prismatic interior mirror, or with a compass electrochromic interior mirror) for an individual vehicle as it passes down the vehicle assembly line. Thus, the automaker can offer a wide array of options to a consumer from an option menu. Should a specific customer select an external temperature display for a particular vehicle due to be manufactured by an automaker at a particular location on a specific day/hour, then the mirror system supplier sends to the vehicle assembly plant, in-sequence and/or just-in-time, a set of an interior rearview mirror assembly and at least one outside sideview mirror assembly for that particular vehicle being produced that day on the assembly line, and with the outside sideview mirror equipped with an external temperature sensor and with the interior rearview mirror assembly equipped with an external temperature display. Such just-in-time, in-sequence supply (which can be used for the incorporation of the various added features recited supra and below) is facilitated when the vehicle utilizes a car area network such as is described in Irish Patent Application No: 970014 entitled "A Vehicle Rearview Mirror and A Vehicle Control System Incorporating Such Mirror", application date Jan. 9, 1997, the disclosure of which is hereby incorporated by reference herein, or when multiplexing is used, such as is disclosed in U.S. patent application Ser. No. 08/679,681 entitled "Vehicles Mirror Digital Network and Dynamically Interactive Mirror System", invented by O'Farrell et al., and filed Jul. 11, 1996, the disclosure of which is hereby incorporated by reference herein. Also, given that an interior electrochromic mirror can optionally be equipped with a myriad of features (such as map lights, reverse inhibit line, headlamp activation, external temperature display, remote keyless entry control, and the like), it is useful to equip such assemblies with a standard connector (for example, a 10-pin parallel connector) so that a common standard wiring harness can be provided across an automaker's entire product range. Naturally, multiplexing within the vehicle can help alleviate the need for more pins on such a connector, or allow a given pin or set of pins control more than one function.

Polychromic solid films can be used in added feature interior rearview mirror assemblies including those that include a loudspeaker (such as for a vehicle audio system, radio or the like, or for a cellular phone including a video

cellular phone). Such loudspeaker may be a high frequency speaker that is mounted at, within, or on the interior rearview mirror assembly (such as within the mirror housing or attached as a module-type pod to the mirror mount such as is described supra) and with its audio output, preferably, directed towards the front windshield of the vehicle so that the windshield itself at least partially reflects the audio output of the speaker (that preferably is a tweeter speaker, more preferably is a compact (such as about 1"x1"x1" in dimensions or smaller), and most preferably utilizes a neodymium magnet core) back into the interior cabin of the vehicle. The interior rearview mirror assembly can also include a microphone and a digital (or a conventional magnetic tape) recorder that can be used by vehicle occupants to record messages and the like. A display can be provided that receives paging information from a pager incorporated in the interior rearview mirror assembly and that displays messages to the driver (preferably via a scrolling display) or to other occupants. The interior rearview mirror assembly can include a digital storage of information such as phone numbers, message reminders, calendar information and the like, that can automatically, or on demand, display information to the driver.

Each of the documents cited in the present teaching is herein incorporated by reference to the same extent as if each document had individually been incorporated by reference.

In view of the above description of the instant invention, it is evident that a wide range of practical opportunities is provided by the teaching herein. The following examples illustrate the benefits and utility of the present invention and are provided only for purposes of illustration, and are not to be construed so as to limit in any way the teaching herein.

EXAMPLES

In each of these examples, we selected random assemblies, fractured the substrates of the assemblies and scraped the polychromic solid film that had formed during the transformation process within the assembly from the broken substrate.

Scatter Safety Aspect of Electrochromic Devices Manufactured With Polychromic Solid Films

To demonstrate the safety performance of the electrochromic devices manufactured according to the these examples, we simulated the impact of an accident by impacting the glass substrates of randomly selected devices with a solid object so as to shatter the glass substrates of those devices. We observed that in each instance the shattered glass was held in place by the polychromic solid film such that glass shards from the broken substrates did not separate and scatter from the device.

Stability and Cyclability of Electrochromic Devices Manufactured with Polychromic Solid Films

In general, we observed good cycle stability, heat stability, performance under prolonged coloration and ultraviolet stability of the electrochromic devices manufactured with the polychromic solid films of the present invention.

To demonstrate the cycle stability, ultraviolet stability and thermal stability of some of the electrochromic devices manufactured with the polychromic solid films of the present invention, we subjected electrochromic mirrors to (1) 15 seconds color—15 seconds bleach cycles at both room temperature and about 50° C.; (2) ultraviolet stability tests by exposing the electrochromic mirrors to at least about 900 KJ/m² using a Xenon Weatherometer as per SAE J1960 and (3) thermal stability tests at about 85° C.

In these mirrors, we observed no change of electrochromic performance or degrading of the electrochromic devices

after more than about 100,000 cycles (15 seconds color—15 seconds bleach) at room temperature and more than about 85,000 cycles (15 seconds color—15 seconds bleach) at about 50° C., and after exposure to about 900 KJ/m² of ultraviolet radiation and to about 85° C. for about 360 hours indicating excellent cycle stability and weatherability.

Example 1

In this example, we chose a RMPT-HVBF₄ electrochromic pair, in conjunction with a commercially available ultraviolet curable formulation, to illustrate the beneficial properties and characteristics of the polychromic solid films and electrochromic interior automotive mirrors manufactured therewith.

A. Synthesis and Isolation of RMPT

We synthesized 2-methyl-phenothiazine-3-one according to the procedure described in European Patent Publication EP 0 115 394 (Merck Frosst Canada). To reduce MPT to RMPT, we followed the redox procedure described in commonly assigned co-pending U.S. patent application Ser. No. 07/935,784 (filed Aug. 27, 1992).

B. Preparation of Electrochromic Monomer Composition

We prepared an electrochromic monomer composition according to the present invention comprising about 3.7% HVBF₄ (as a cathodic compound), about 1.6% RMPT (as an anodic compound), both homogeneously dispersed in a combination of about 47.4% propylene carbonate (as the plasticizer) and, as a monomer component, about 52.6% "IMPRUV" (an ultraviolet curable formulation). We thoroughly mixed this electrochromic monomer composition to ensure that a homogeneous dispersion of the components was achieved.

C. Mirror Assembly with Electrochromic Monomer Composition

We assembled interior automotive mirrors from HW-ITO coated glass substrates (where the conductive surface of each glass substrate faced one another), with both the clear, front glass and the silvered, rear glass having a sheet resistance of about 15 ohms per square. The dimensions of the mirror assemblies were about 2.5"×10"×37 μm, with a weather barrier of an epoxy resin coupled with spacers of about 37 μm also applied.

We placed into the mirror assemblies the electrochromic monomer composition of Example 1(B), supra, by the vacuum backfilling technique [as described in Varaprasad III, supra].

D. Transformation of Electrochromic Monomer Composition Within Mirror to Polychromic Solid Film

Once the electrochromic monomer composition of Example 1(B), supra, was uniformly applied within the mirror assemblies of Example 1(C), supra, we placed the assemblies onto the conveyor belt of a Fusion UV Curing System F-300 B. While the belt advanced initially at a rate of about twenty-five feet per minute, we exposed the assemblies to ultraviolet radiation generated by the D fusion lamp of the F-300 B. We passed the assemblies under the fusion lamp light eight times at that rate, pausing momentarily between passes to allow the assemblies to cool, then eight times at a rate of about fifteen feet per minute again pausing

momentarily between passes to allow the assemblies to cool and finally three times at a rate of about ten feet per minute with the aforementioned pausing between passes.

E. Use of Electrochromic Mirror

We applied a potential of about 1.3 volts to one of the electrochromic mirrors, and thereafter observed this mirror to color rapidly and uniformly to a bluish purple color.

In addition, we observed that the high reflectance at the center portion of the mirror was about 71% reflectance which decreased to a low reflectance of about 10.8% when about 1.3 volts was applied thereto. The response time for the reflectance to change from about 70% to about 20% when that potential was applied thereto was about 3.7 seconds. We made this determination by following the SAE J964a standard procedure of the Society of Automotive Engineers, with a reflectometer—set in reflectance mode—equipped with a light source (known in the art as Illuminant A) and a photopic detector assembly interfaced with a data acquisition system.

We also observed that the mirror bleached from about 20% reflectance to about 60% reflectance in a response time of about 7.1 seconds under about a zero applied potential. We noted the bleaching to be uniform, and the bleached appearance to be silvery.

Example 2

In this example, we chose a RMPT-HVBF₄ electrochromic pair, in conjunction with a combination of commercially available ultraviolet curable formulations, to illustrate the beneficial properties and characteristics of the polychromic solid film and the electrochromic interior automotive mirrors manufactured therewith by using the sandwich lamination technique.

A. Preparation of Electrochromic Monomer Composition

We prepared an electrochromic monomer composition comprising by weight about 2.6% HVBF₄ (as a cathodic compound), about 1.2% RMPT (as an anodic compound), both homogeneously dispersed in a combination of about 40% propylene carbonate (as a plasticizer) and, in combination as a monomer component, about 50% "QUICK CURE" B-565 (an acrylated urethane/ultraviolet curable formulation) and about 10% "ENVIBAR" UV 1244 (a cycloalkyl epoxide/ultraviolet curable formulation). We thoroughly mixed this electrochromic monomer composition to ensure that a homogeneous dispersion of the components was achieved.

B. Mirror Assembly With Electrochromic Monomer Composition

In this example, we assembled interior automotive mirrors by dispensing a portion of the electrochromic monomer composition of Example 2(A), supra, onto the conductive surface of a tin oxide-coated glass substrate (the other surface of the substrate being silver-coated so as to form a mirror) onto which we also placed 37 μm glass beads, and then positioned thereover the conductive surface of a clear, tin oxide-coated glass substrate. These glass substrates, commercially available under the trade name "TEC-Glass" products as "TEC-20" from Libbey-Owens-Ford Co., Toledo, Ohio, having dimensions of about 3"×6", were assembled to form an interpane distance between the glass substrates of about 37 μm. In this way, the electrochromic

monomer composition was located between the conductive surface of the two glass substrates of the mirror assemblies.

C. Transformation of Electrochromic Monomer Composition within Mirror to Polychromic Solid Film

Once the electrochromic monomer composition of Example 2(A), supra, was uniformly applied within the mirror assemblies of Example 2(B), supra, we placed the assemblies onto the conveyor belt of a Fusion UV Curing System F-300 B. While the belt advanced initially at a rate of about twenty feet per minute, we exposed the assemblies to ultraviolet radiation generated by the D fusion lamp of the F-300 B. We passed the assemblies under the fusion lamp light twelve times at that rate, pausing between every third or fourth pass to allow the assemblies to cool.

D. Use of Electrochromic Mirrors

We applied a potential of about 1.3 volts to one of the mirrors, and thereafter observed that the mirror colored rapidly and uniformly to a bluish purple color.

In addition, we observed that the high reflectance at the center portion of the mirror was about 57% reflectance which decreased to a low reflectance of about 9.3%. The response time for the reflectance to change from about 55% to about 20% was about 10 seconds when a potential of about 1.3 volts was applied thereto. We made this determination by the reflectometer described in Example 1, supra.

We also observed that the mirror bleached from about 10% reflectance to about 50% reflectance in a response time of about 56 seconds under about zero applied potential. We noted the bleaching to be uniform, and the bleached appearance to be silvery.

Example 3

In this example, we compared the beneficial properties and characteristics of a polychromic solid film prepared using ferrocene as an anodic electrochromic compound, and manufactured within an exterior automotive mirror [Example 3(B)(1) and (D)(1), infra] and interior automotive mirrors [Example 3(B)(2) and (D)(2), infra]. We also installed an interior automotive mirror as a rearview mirror in an automobile to observe its performance under conditions attendant with actual automotive use.

A. Preparation of Electrochromic Monomer Composition

We prepared an electrochromic monomer composition comprising by weight about 4.4% EVCIO_4 (as a cathodic compound), about 2% ferrocene (as an anodic compound), both homogeneously dispersed in a combination comprising, in combination as the plasticizer component, about 48.6% propylene carbonate and about 8.8% cyanoethyl sucrose and, in combination as a monomer component, about 17.7% caprolactone acrylate and about 13.3% polyethylene glycol diacrylate (400). We also added about 0.9% benzoin i-butyl ether (as a photoinitiator) and about 4.4% "UVINUL" N 35 (as an ultraviolet stabilizing agent), and thoroughly mixed this electrochromic monomer composition to ensure that a homogeneous dispersion of the components was achieved.

B. Mirror Assembly With Electrochromic Monomer Composition

1. Exterior Automotive Mirror

We assembled exterior automotive mirrors from HW-ITO coated glass substrates (where the conductive surface of

each glass substrate faced one another), with both the clear front glass and the silvered, rear glass having a sheet resistance of about 15 ohms per square. The dimensions of the mirror assemblies were about $3.5'' \times 5.5'' \times 74 \mu\text{m}$, with a weather barrier of an epoxy resin coupled with spacers of about $74 \mu\text{m}$ also applied.

We placed into these mirror assemblies the electrochromic monomer composition of Example 3(A), supra, using the vacuum backfilling technique [as described in Varaprasad III, supra].

2. Interior Automotive Mirror

We assembled interior automotive mirrors from HW-ITO coated glass substrates (where the conductive surface of each glass substrate faced one another), with both the clear front glass and the silvered, rear glass having a sheet resistance of about 15 ohms per square. The dimensions of the mirror assemblies were about $2.5'' \times 10'' \times 44 \mu\text{m}$, with a weather barrier of an epoxy resin coupled with spacers of about $44 \mu\text{m}$ also applied.

We placed into these mirror assemblies the electrochromic monomer composition of Example 3(A), supra, using the vacuum backfilling technique [as described in Varaprasad III, supra].

C. Transformation of Electrochromic Monomer Composition Within Mirror to Polychromic Solid Film

Once the electrochromic monomer composition of Example 3(A), supra, was uniformly applied within each of the respective mirror assemblies of Example 3(B)(1) and (2), supra, we placed the assemblies onto the conveyor belt of a Fusion UV Curing System F-300 B, and exposed the assemblies to ultraviolet radiation in the same manner as described in Example 1(D), supra.

D. Use of Electrochromic Mirror

We applied a potential of about 1.3 volts to one of the electrochromic mirrors of Example 3(B), supra, and to two of the electrochromic mirrors of Example 3(C), supra. Our observations follow.

1. Exterior Automotive Mirror

We observed that the electrochromic mirror colored rapidly and uniformly to a blue color with a greenish hue.

In addition, we observed that the high reflectance at the center portion of the exterior mirror decreased from about 80.5% to about 5.7%, with a change in the reflectance of about 70% to about 20% in a response time of about 5.0 seconds when a potential of about 1.3 volts was applied thereto. We made this determination by the reflectometer described in Example 1, supra.

We also observed that the mirror bleached from about 10% reflectance to about 60% reflectance in a response time of about 9.2 seconds, under about a zero applied potential. We noted the bleaching to be uniform, and the bleached appearance to be silvery.

2. Interior Automotive Mirror

We observed that each of a first and second electrochromic mirror colored rapidly and uniformly to a blue color with a greenish hue.

In addition, we observed that for the first mirror the high reflectance at the center portion of the interior mirror

decreased from about 80.2% to about 6.3%, with a change in the reflectance of about 70% to about 20% in a response time of about 3.1 seconds when a potential of about 1.3 volts was applied thereto. The second mirror exhibited comparable results, with the reflectance decreasing from about 78.4% to about 7.5% in about 2.7 seconds. We made these determinations by the reflectometer described in Example 1, supra.

We also observed that the first mirror bleached from about 10% reflectance to about 60% reflectance in a response time of about 3.9 seconds under about a zero applied potential, and the second mirror bleached to the same extent in about 3.6 seconds. We noted the bleaching to be uniform, and the bleached appearance to be silvery.

We have successfully installed and operated such an electrochromic mirror in an automobile as a rearview mirror and achieved excellent results.

Example 4

In this example, we chose t-butyl ferrocene as the anodic electrochromic compound together with a monomer component containing the combination of a monomer and a commercially available ultraviolet curable formulation to illustrate the beneficial properties and characteristics of the polychromic solid films made therefrom and the electrochromic interior automotive mirrors manufactured therewith.

A. Preparation of Electrochromic Monomer Composition

We prepared an electrochromic monomer composition comprising by weight about 3.9% EVCIO_4 (as a cathodic compound), about 2.3% t-butyl ferrocene (as an anodic compound), both homogeneously dispersed in a combination comprising about 61.7% propylene carbonate (as a plasticizer) and, in combination as a monomer component, about 10.70 caprolactone acrylate and about 10.6% "SAR-BOX" acrylate resin (SB 500) (an ultraviolet curable formulation). We also added about 1.3% "IRGACURE" 184 (as a photoinitiator) and about 4.4% "UVINUL" N 35 (as an ultraviolet stabilizing agent), and thoroughly mixed this electrochromic monomer composition to ensure that a homogeneous dispersion of the components was achieved.

B. Mirror Assembly With Electrochromic Monomer Composition

We assembled interior automotive mirrors from HWG-ITO coated glass substrates (where the conductive surface of each glass substrate faced one another), with both the clear, front glass and the silvered, rear glass having a sheet resistance of about 15 ohms per square. The dimensions of the mirror assemblies were about $2.5" \times 10" \times 53 \mu\text{m}$, with a weather barrier of an epoxy resin coupled with spacers of about $53 \mu\text{m}$ also applied.

We placed into these mirror assemblies the electrochromic monomer composition of Example 4(A), supra, using the vacuum backfilling technique [as described in Varaprasad III, supra].

C. Transformation of Electrochromic Monomer Composition Within Mirror to Polychromic Solid Film

Once the electrochromic monomer composition of Example 4(A), supra, was uniformly applied within the mirror assemblies of Example 4(B), supra, we placed the

assemblies onto the conveyor belt of a Fusion UV Curing System F-300 B, and exposed the assemblies to ultraviolet radiation in the same manner as described in Example 1(D), supra.

D. Use of Electrochromic Mirror

We applied a potential of about 1.3 volts to one of the electrochromic mirrors of Example 4(B) and (C), supra, and observed this mirror to color rapidly and uniformly to a blue color with a greenish hue.

In addition, we observed that the high reflectance at the center portion of the mirror was about 79.3% reflectance which decreased to a low reflectance of about 9.8% when about 1.3 volts was applied thereto. The response time for the reflectance to change from about 70% to about 20% when that potential was applied thereto was about 2.3 seconds. We made this determination by the reflectometer described in Example 1, supra.

We also observed that the mirror bleached from about 10% reflectance to about 60% reflectance in a response time of about 3.0 seconds under about a zero applied potential. We noted the bleaching to be uniform.

Examples 5 through 8

In Examples 5 through 8, we compared the beneficial properties and characteristics of polychromic solid films prepared from ferrocene, and three alkyl derivatives thereof, as the anodic electrochromic compound and manufactured within interior automotive mirrors.

Example 5

A. Preparation of Electrochromic Monomer Composition

We prepared an electrochromic monomer composition according to the present invention comprising about 3.5% EVCIO_4 (as a cathodic compound), about 2.1% dimethyl ferrocene (as an anodic compound), both homogeneously dispersed in a combination of about 51.5% propylene carbonate (as a plasticizer) and about 34.3% "QUICK CURE" B-565 (as a monomer component). We also added about 8.6% "UVINUL" N 35 (as an ultraviolet stabilizing agent), and thoroughly mixed this electrochromic monomer composition to ensure that a homogeneous dispersion of the components was achieved.

B. Mirror Assembly With Electrochromic Monomer Composition

We assembled interior automotive mirrors from HWG-ITO coated glass substrates (where the conductive surface of each glass substrate faced one another), with both the clear, front glass and the silvered, rear glass having a sheet resistance of about 15 ohms per square. The dimensions of the mirror assemblies were about $2.5" \times 10" \times 53 \mu\text{m}$, with a weather barrier of an epoxy resin coupled with spacers of about $53 \mu\text{m}$ also applied.

We placed into these mirror assemblies the electrochromic monomer composition of Example 5(A), supra, using the vacuum backfilling technique [as described in Varaprasad III, supra].

C. Transformation of Electrochromic Monomer Composition Within Mirror to Polychromic Solid Film

Once the electrochromic monomer composition of Example 5(A), supra, was uniformly applied within the

61

mirror assemblies of Example 5(B), supra, we placed the assemblies onto the conveyor belt of a Fusion UV Curing System F-300 B, and exposed the assemblies to ultraviolet radiation in the same manner as described in Example 2(C), supra.

D. Use of Electrochromic Mirror

We applied a potential of about 1.3 volts to one of the electrochromic mirrors, and thereafter observed this mirror to color rapidly and uniformly to a blue color with a greenish hue.

In addition, we observed that the high reflectance at the center portion of the mirror was about 71.9% reflectance which decreased to a low reflectance of about 7.5% when about 1.3 volts was applied thereto. The response time for the reflectance to change from about 70% to about 20% when that potential was applied thereto was about 2.4 seconds. We made this determination by the reflectometer described in Example 1, supra.

We also observed that the mirror bleached from about 10% reflectance to about 60% reflectance in a response time of about 4.2 seconds under about a zero applied potential. We noted the bleaching to be uniform.

Example 6

A. Preparation of Electrochromic Monomer Composition

We prepared an electrochromic monomer composition according to the present invention comprising about 3.5% EVCIO_4 (as a cathodic compound), about 2.3% n-butyl ferrocene (as an anodic compound), both homogeneously dispersed in a combination of about 51.3% propylene carbonate (as a plasticizer) and about 34.3% "QUICK CURE" B-565 (as a monomer component). We also added about 8.6% "UVINUL" N 35 (as an ultraviolet stabilizing agent), and thoroughly mixed this electrochromic monomer composition to ensure that a homogeneous dispersion of the components was achieved.

B. Mirror Assembly with Electrochromic Monomer Composition

We assembled interior automotive mirrors from HWG-ITO coated glass substrates (where the conductive surface of each glass substrate faced one another), with both the clear, front glass and the silvered, rear glass having a sheet resistance of about 15 ohms per square. The dimensions of the mirror assemblies were about $2.5 \times 10 \times 53 \mu\text{m}$, with a weather barrier of an epoxy resin coupled with spacers of about $53 \mu\text{m}$ also applied.

We placed into these mirror assemblies the electrochromic monomer composition of Example 6(A), supra, using the vacuum backfilling technique [as described in Varaprasad III, supra].

C. Transformation of Electrochromic Monomer Composition Within Mirror to Polychromic Solid Film

Once the electrochromic monomer composition of Example 6(A), supra, was uniformly applied within the mirror assemblies of Example 6(B), supra, we placed the assemblies onto the conveyor belt of a Fusion UV Curing System F-300 B, and exposed the assemblies to ultraviolet radiation in the same manner as described in Example 2(C), supra.

62

D. Use of Electrochromic Mirror

We applied a potential of about 1.3 volts to one of the electrochromic mirrors, and thereafter observed this mirror to color rapidly and uniformly to a blue color with a greenish hue.

In addition, we observed that the high reflectance at the center portion of the mirror was about 73.8% reflectance which decreased to a low reflectance of about 7.8% when about 1.3 volts was applied thereto. The response time for the reflectance to change from about 70% to about 20% when that potential was applied thereto was about 2.5 seconds. We made this determination by the reflectometer described in Example 1, supra.

We also observed that the mirror bleached from about 10% reflectance to about 60% reflectance in a response time of about 4.3 seconds under about a zero applied potential. We noted the bleaching to be uniform.

Example 7

A. Preparation of Electrochromic Monomer Composition

We prepared an electrochromic monomer composition according to the present invention comprising about 3.5% EVCIO_4 (as a cathodic compound), about 2.3% t-butyl ferrocene (as an anodic compound), both homogeneously dispersed in a combination of about 51.3% propylene carbonate (as a plasticizer) and about 34.3% "quick CURE" B-565 (as a monomer component). We also added about 8.6% "UVINUL" N 35 (as an ultraviolet stabilizing agent), and thoroughly mixed this electrochromic monomer composition to ensure that a homogeneous dispersion of the components was achieved.

B. Mirror Assembly with Electrochromic Monomer Composition

We assembled interior automotive mirrors from HWG-ITO coated glass substrates (where the conductive surface of each glass substrate faced one another), with the clear, front glass and the silvered, rear glass having a sheet resistance of about 15 ohms per square. The dimensions of the mirror assemblies were about $2.5 \times 10 \times 53 \mu\text{m}$, with a weather barrier of an epoxy resin coupled with spacers of about $53 \mu\text{m}$ also applied.

We placed into these mirror assemblies the electrochromic monomer composition of Example 7(A), supra, using the vacuum backfilling technique [as described in Varaprasad III, supra].

C. Transformation of Electrochromic Monomer Composition Within Mirror to Polychromic Solid Film

Once the electrochromic monomer composition as of Example 7(A), supra, was uniformly applied within the mirror assemblies of Example 7(B), supra, we placed the assemblies onto the conveyor belt of a Fusion UV Curing System F-300 B, and exposed the assemblies to ultraviolet radiation in the same manner as described in Example 2(C), supra.

D. Use of Electrochromic Mirror

We applied a potential of about 1.3 volts to one of the electrochromic mirrors, and thereafter observed this mirror to color rapidly and uniformly to a blue color with greenish hue.

63

In addition, we observed that the high reflectance at the center portion of the mirror was about 73.1% reflectance which decreased to a low reflectance of about 7.8% when about 1.3 volts was applied thereto. The response time for the reflectance to change from about 70% to about 20% when that potential was applied thereto was about 2.5 seconds. We made this determination by the reflectometer described in Example 1, supra.

We also observed that the mirror bleached from about 10% reflectance to about 60% reflectance in a response time of about 4.3 seconds under about a zero applied potential. We noted the bleaching to be uniform.

Example 8

A. Preparation of Electrochromic Monomer Composition

We prepared an electrochromic monomer composition according to the present invention comprising about 3.5% EVClO₄ (as a cathodic compound), about 1.8% ferrocene (as an anodic compound), both homogeneously dispersed in a combination of about 51.8% propylene carbonate (as a plasticizer) and about 34.3% "quick CURE" B-565 (as a monomer component). We also added about 8.6% "UVINUL" N 35 (as an ultraviolet stabilizing agent), and thoroughly mixed this electrochromic monomer composition to ensure that a homogeneous dispersion of the components was achieved.

B. Mirror Assembly with Electrochromic Monomer Composition

We assembled interior automotive mirrors from HWG-ITO coated glass substrates (where the conductive surface of each glass substrate faced one another), with the clear, front glass and the silvered, rear glass having a sheet resistance of about 15 ohms per square. The dimensions of the mirror assemblies were about 2.5" x 10" x 53 μm, with a weather barrier of an epoxy resin coupled with spacers of about 53 μm also applied.

We placed into these mirror assemblies the electrochromic monomer composition of Example 8(A), supra, using the vacuum backfilling technique [as described in Varaprasad III, supra].

C. Transformation of Electrochromic Monomer Composition Within Mirror to Polychromic Solid Film

Once the electrochromic monomer composition of Example 8(A), supra, was uniformly applied within the mirror assemblies of Example 8(B), supra, we placed the assemblies onto the conveyor belt of a Fusion UV Curing System F-300 B, and exposed the assemblies to ultraviolet radiation in the same manner as described in Example 2(C), supra.

D. Use of Electrochromic Mirror

We applied a potential of about 1.3 volts to one of the electrochromic mirrors, and thereafter observed this mirror to color rapidly and uniformly to a blue color with a greenish hue.

In addition, we observed that the high reflectance at the center portion of the mirror was about 72.7% reflectance which decreased to a low reflectance of about 7.9% when about 1.3 volts was applied thereto. The response time for the reflectance to change from about 70% to about 20%

64

when that potential was applied thereto was about 2.7 seconds. We made this determination by the reflectometer described in Example 1, supra.

We also observed that the mirror bleached from about 10% reflectance to about 60% reflectance in a response time of about 4.8 seconds under about a zero applied potential. We noted the bleaching to be uniform.

Example 9

A. Preparation of Electrochromic Monomer Composition

We prepared an electrochromic monomer composition comprising by weight about 3.9% EVClO₄ (as a cathodic compound), about 1.2% t-butyl ferrocene and about 1.0% DMPA (in combination as the anodic compound), homogeneously dispersed in a combination comprising about 45% propylene carbonate, about 8.9% cyanoethyl sucrose and about 8.9% 3-hydroxypropionitrile (in combination as a plasticizer component) and, in combination as a monomer component, about 17.7% caprolactone acrylate, about 11.5% polyethylene glycol diacrylate (400) and about 1.8% 1,6-hexanediol diacrylate. We also added about 0.9% "IRGACURE" 184 (as a photoinitiator) and about 4.4% "UVINUL" N 35 (as an ultraviolet stabilizing agent), and we thoroughly mixed this electrochromic monomer composition to ensure that a homogeneous dispersion of the components was achieved.

B. Mirror Assembly with Electrochromic Monomer Composition

We assembled interior automotive mirrors from HWG-ITO coated glass substrates (where the conductive surface of each glass substrate faced one another), with the clear, front glass and the silvered, rear glass having a sheet resistance of about 15 ohms per square. The dimensions of the mirror assemblies were about 2.5" x 10" x 44 μm, with a weather barrier of an epoxy resin coupled with spacers of about 44 μm also applied.

We placed into these mirror assemblies the electrochromic monomer composition of Example 9(A), supra, using the vacuum backfilling technique [as described in Varaprasad III, supra].

C. Transformation of Electrochromic Monomer Composition Within Mirror to Polychromic Solid Film

Once the electrochromic monomer composition of Example 9(A), supra, was uniformly applied within the mirror assemblies of Example 9(B), supra, we placed the assemblies onto the conveyor belt of a Fusion UV Curing System F-300 B, and exposed the assemblies to ultraviolet radiation in the same manner as described in Example 1(D), supra.

D. Use of Electrochromic Mirror

We applied a potential of about 1.3 volts to one of the electrochromic mirrors, and thereafter observed that the mirror colored rapidly and uniformly to a bluish green color.

In addition, we observed that the high reflectance at the center portion of the mirror was about 78.2% decreased to a low reflectance of about 8.2%, with a change in the reflectance of about 70% to about 20% in a response time of about 1.9 seconds when a potential of about 1.3 volts was applied thereto. We made this determination by the reflectometer described in Example 1, supra.

We also observed that the mirror bleached from about 10% reflectance to about 60% reflectance in a response time of about 5.4 seconds under about a zero applied potential. We noted the bleaching to be uniform.

Example 10

In this example, like Example 2, we chose to illustrate the sandwich lamination technique of manufacturing electrochromic devices to demonstrate its efficiency in the context of the present invention.

A. Preparation of Electrochromic Monomer Composition

We prepared an electrochromic monomer composition comprising by weight about 3.0% EVCIO_4 (as a cathodic compound), about 1.9% t-butyl ferrocene (as an anodic compound), both homogeneously dispersed in a combination of about 31.7% propylene carbonate (as a plasticizer), and, in combination as a monomer component, about 31.7% "QUICK CURE" B-565 and about 31.7% Urethane Acrylate (Soft) (CN 953). We thoroughly mixed this electrochromic monomer composition to ensure that a homogenous dispersion of the components was achieved.

B. Mirror Assembly With Electrochromic Monomer Composition

We assembled rectangular mirrors by dispensing a portion of the electrochromic monomer composition of Example 10(A), supra, onto the conductive surface of a silvered "TEC-20" glass substrate onto which we also placed 150 μm glass beads, and then positioned thereover the conductive surface of a clear "TEC-20" glass substrate. We assembled these glass substrates, having dimensions of about 5.5" x 7", under moderate pressure to form an interpane distance between the glass substrates of about 150 μm . In this way, the electrochromic monomer composition was located between the conductive surfaces of the two glass substrates of the mirror assemblies.

C. Transformation of Electrochromic Monomer Composition Within Mirror to Polychromic Solid Film

Once the electrochromic monomer composition of Example 10(A), supra, was uniformly applied within the mirror assemblies of Example 10(B), supra, we placed the assemblies onto the conveyor belt of a Fusion UV Curing System F-300 B, and exposed the assemblies to ultraviolet radiation in the same manner as described in Example 2(C), supra.

D. Use of Electrochromic Mirrors

We applied a potential of about 1.3 volts to one of the electrochromic mirror, and thereafter observed that the mirror colored rapidly and uniformly to a greenish blue color.

In addition, we observed that the high reflectance at the center portion of the mirror was about 66.7% reflectance which decreased to a low reflectance of about 5.8%. The response time for the reflectance to change from about 60% to about 5.9% was about 30 seconds when a potential of about 1.3 volts was applied thereto. We made this determination by the reflectometer described in Example 1, supra.

We also observed that the mirror bleached from about 5.9% reflectance to about 60% reflectance in a response time of about 180 seconds under about zero applied potential.

Example 11

In this example, we chose to illustrate the beneficial properties and characteristics of the polychromic solid films

manufactured within electrochromic glazings, that may be used as small area transmissive devices, such as optical filters and the like.

A. Preparation of Electrochromic Monomer Composition

We prepared an electrochromic monomer composition comprising by weight about 2.5% HVBF_4 (as a cathodic compound), about 1.1% MPT having been previously reduced by contacting with zinc [see Varaprasad IV and commonly assigned co-pending U.S. patent application Ser. No. 07/935,784] (as an anodic compound), both homogeneously dispersed in a combination comprising, in combination as a plasticizer, about 47.7% propylene carbonate and about 1% acetic acid, and about 47.7% "QUICK CURE" B-565 (as a monomer component). We thoroughly mixed this electrochromic monomer composition to ensure that a homogeneous dispersion of the components was achieved.

B. Glazing Assembly With Electrochromic Monomer Composition

We assembled electrochromic glazings from HW-ITO coated glass substrates (where the conductive surface of each glass substrate faced one another), with the glass having a sheet resistance of about 15 ohms per square. The dimensions of the glazing assemblies were about 2.5" x 10" x 53 μm , with a weather barrier of an epoxy resin coupled with spacers of about 53 μm also applied.

We placed into these glazing assemblies the electrochromic monomer composition of Example 11(A), supra, using the vacuum backfilling technique [as described in Varaprasad III, supra].

C. Transformation of Electrochromic Monomer Composition Within Glazing to Polychromic Solid Film

Once the electrochromic composition of Example 11(A), supra, was uniformly applied within the glazing assemblies of Example 11(B), supra, we placed the assemblies onto the conveyor belt of a Fusion UV Curing System F-300 B, and exposed the assemblies to ultraviolet radiation in the same manner as described in Example 1(D), supra.

D. Use of Electrochromic Glazing

We applied a potential of about 1.3 volts to the electrochromic glazings of Example 11(B) and (C), supra. We observed that the electrochromic glazings colored rapidly and uniformly to a bluish purple color.

In addition, we observed that the high transmission at the center portion of the glazing decreased from about 79.2% to about 7.4%, with a changed transmission of about 70% to about 20% in a response time of about 4.4 seconds when a potential of about 1.3 volts was applied thereto. We made this determination by the detection method described in Example 1, supra, except that the reflectometer was set in transmission mode.

We also observed that the glazing bleached from about 15% transmission to about 60% transmission in a response time of about 8.4 seconds, under about a zero applied potential. We noted good cycle stability, ultraviolet stability and thermal stability.

Example 12

A. Preparation of Electrochromic Monomer Composition

We prepared an electrochromic monomer composition comprising by weight about 3.7% HVBF_4 (as a cathodic

compound), about 1.6% RMPT (as an anodic compound), both homogeneously dispersed in a combination comprising about 46.2% 3-hydroxypropionitrile (as a plasticizer), and, in combination as a monomer component, about 23.1% 2-(2-ethoxyethoxy)-ethylacrylate and about 23.1% tetraethylene glycol diacrylate. We also added about 2.3% "ESACURE" TZI (as a photoinitiator), and thoroughly mixed this electrochromic monomer composition to ensure that a homogeneous dispersion of the components was achieved.

B. Mirror Assembly With Electrochromic Monomer Composition

We assembled electrochromic mirrors from "TEC-20" glass substrates (where the conductive surface of each glass substrate faced one another), having dimensions of about 2.5"×10"×37 μm, with a weather barrier of an epoxy resin coupled with spacers of about 37 μm also applied.

We placed into these mirror assemblies the electrochromic monomer composition of Example 12(A), supra, using the vacuum backfilling technique [as described in Varasprad III, supra].

C. Transformation of Electrochromic Monomer Composition Within Mirror to Polychromic Solid Film

Once the electrochromic monomer composition of Example 12(A), supra, was uniformly applied within the mirror assemblies of Example 12(B), supra, we placed the assemblies onto the conveyor belt of a Fusion UV Curing System F-300 B, and exposed the assemblies to ultraviolet radiation in the same manner as described in Example 1(D), supra.

D. Use of Electrochromic Mirror

We applied a potential of about 1.3 volts to one of the electrochromic mirrors of Example 12(B) and (C), supra, and observed this mirror to color rapidly and uniformly to a bluish purple color.

In addition, we observed that the high reflectance at the center portion of the mirror was about 68.4% reflectance which decreased to a low reflectance of about 13.3% when about 1.3 volts was applied thereto. The response time for the reflectance to change from about 65% to about 20% when that potential was applied thereto was about 3.0 seconds. We made this determination by the reflectometer described in Example 1, supra.

We also observed that the mirror bleached from about 15% reflectance to about 60% reflectance in a response time of about 3.0 seconds under about a zero applied potential. We noted the bleaching to be uniform, and the bleached appearance to be silvery.

Example 13

In this example, we chose to illustrate the beneficial properties and characteristics of polychromic solid films manufactured within electrochromic glazings consisting of sun roofs using a compatibilizing plasticizer component. Also, in this example, we chose to formulate the electrochromic monomer composition with an additional monomer having polyfunctionality as a compatibilizing agent for the polychromic solid film.

A. Preparation of Electrochromic Monomer Composition

We prepared an electrochromic monomer composition according to the present invention comprising about 4.0%

HVBF₄ (as a cathodic compound), about 1.7% RMPT (as an anodic compound), both homogeneously dispersed in a combination comprising, in combination as a plasticizer, about 10.2% propylene carbonate, about 17% benzyl acetone and about 14.7% cyanoethyl sucrose, and, in combination as a monomer component, about 33.5% "QUICK CURE" B-565 and about 18.9% polyethylene glycol diacrylate (400). We thoroughly mixed this electrochromic monomer composition to ensure that a homogeneous dispersion of the components was achieved.

B. Glazing Assembly with Electrochromic Monomer Composition

We constructed a glazing assembly consisting of a sun roof model by dispensing a portion of the electrochromic monomer composition of Example 13(A), supra, onto the conductive surface of a "TEC-10" glass substrate onto which we also placed 100 μm glass beads, and then positioned thereover another "TEC-10" glass substrate, so that the electrochromic monomer composition was between and in contact with the conductive surface of the two glass substrates. We used "TEC-10" glass substrates having dimensions of about 6"×16.5", with bus bars attached at the lengthwise side of the substrates to create a distance therebetween of about 16.5". The interpane distance between the "TEC-10" glass substrates was about 100 μm.

C. Transformation of Electrochromic Monomer Composition Within Glazing Assembly to Polychromic Solid Film

Once the electrochromic monomer composition of Example 13(A), supra, was uniformly applied within the glazing assembly of Example 13(B), supra, we placed the assembly onto the conveyor belt of a Fusion UV Curing System F-300 B, and exposed the assembly to ultraviolet radiation in the same manner as described in Example 2(C), supra.

D. Use of Electrochromic Glazing Assembly

We applied a potential of about 1.3 volts to the glazing assembly, and thereafter observed the assembly to color rapidly and uniformly to a bluish purple color.

In addition, we observed that the high transmission at the center portion of the glazing assembly was about 60.70% transmission which decreased to a low transmission of about 6.0% when about 1.3 volts was applied thereto. The response time for the transmission to change from about 60% to about 10% when that potential was applied thereto was about 3.8 minutes. We made this determination by the detection method described in Example 1, supra, except that the reflectometer was set in transmission mode.

We also observed that the glazing assembly bleached from about 10% transmission to about 45 transmission in a response time of about 4.2 minutes under about a zero applied potential.

Example 14

In this example, we chose to manufacture large area electrochromic mirrors, by the two hole filling technique, to demonstrate the beneficial properties and characteristics of the polychromic solid films within large truck mirrors.

A. Preparation of Electrochromic Monomer Composition

We prepared an electrochromic monomer composition comprising by weight about 1.9% EVCIO₄ (as a cathodic

69

compound), about 1.2% RMPT (as an anodic compound), both homogeneously dispersed in a combination comprising about 53.3% propylene carbonate (as a plasticizer) and about 43.6% "QUICK CURE" B-565 (as a monomer component). We thoroughly mixed this electrochromic monomer composition to ensure that a homogeneous dispersion of the components was achieved.

B. Mirror Assembly with Electrochromic Monomer Composition

We assembled large truck mirrors from FW-ITO glass substrates (where the conductive surface of each glass substrate faced one another), with the clear, front glass and the silvered, rear glass having a sheet resistance of about 6 to about 8 ohms per square. The dimensions of the mirror assemblies were about 6.5"x15"x44 μm , with a weather barrier of an epoxy resin coupled with spacers of about 44 μm also applied.

We placed into these mirror assemblies the electrochromic monomer composition of Example 14(A), supra, using the vacuum backfilling technique [as described in Varaprasad III, supra].

C. Transformation of Electrochromic Monomer Composition Within Mirror to Polychromatic Solid Film

Once the electrochromic monomer composition of Example 14(A), supra, was uniformly applied within the truck mirror assemblies of Example 14(B), supra, we placed the assemblies onto the conveyor belt of a Fusion UV Curing System F-300 B, and exposed the assemblies to ultraviolet radiation in the same manner as described in Example 2(C), supra.

D. Use of Electrochromic Mirror

We applied a potential of about 1.3 volts to one of the electrochromic truck mirrors, and thereafter observed that the mirror colored rapidly and uniformly to a bluish purple color.

In addition, we observed that the high reflectance at the center portion of the mirror was about 67.4% decreased to a low reflectance of about 7.9%, with a changed reflectance of about 65% to about 20% in a response time of about 7.1 seconds when a potential of about 1.3 volts was applied thereto. We made this determination by the reflectometer described in Example 1, supra.

We also observed that the mirror bleached from about 10% reflectance to about 55% reflectance in a response time of about 15.0 seconds under about a zero applied potential, and to its high reflectance shortly thereafter.

The electrochromic truck mirrors performed satisfactorily with its long axis positioned in vertical alignment with the ground.

Example 15

In this example, we have illustrated that the electrochromic monomer composition may be prepared in stages and thereafter used to manufacture polychromatic solid films, and electrochromic devices manufactured with same, that demonstrates the beneficial properties and characteristics herein described. Also, in this example, like Examples 12 and 13, supra, we chose to formulate the electrochromic monomer composition with a difunctional monomer component to illustrate the properties and characteristics attendant with the addition of that component.

70

A. Preparation of Electrochromic Monomer Composition

The electrochromic monomer composition of this example comprised by weight about 3.9% EVCIO₄ (as a cathodic compound), about 2.3% t-butyl ferrocene (as an anodic compound), both homogeneously dispersed in a combination of about 62% propylene carbonate (as the plasticizer), and, in combination as a monomer component, about 20% caprolactone acrylate and about 6.5% polyethylene glycol diacrylate (400). We also added about 0.9% "IRGACURE" 184 (as a photoinitiator) and about 4.4% "UVINUL" N 35 (as an ultraviolet stabilizing agent), and thoroughly mixed this electrochromic monomer composition to ensure that a homogeneous dispersion of the components was achieved.

We prepared the above composition by first combining the propylene carbonate, caprolactone acrylate, polyethylene glycol diacrylate (400) and "IRGACURE" 184, with stirring and bubbling nitrogen gas through the combination, and initiating cure by exposing this combination to a source of fluorescent light at room temperature for a period of time of about 10 minutes. At this point, we removed the source of fluorescent light, and combined therewith the EVCIO₄, t-butyl ferrocene and "UVINUL" N 35 to obtain a homogeneously dispersed electrochromic monomer composition. We monitored the extent of cure by the increase of viscosity.

B. Mirror Assembly With Electrochromic Monomer Composition

We assembled interior automotive mirrors with HWG-ITO coated glass substrates (where the conductive surface of each glass substrate faced one another), with the clear, front glass and the silvered, rear glass having a sheet resistance of about 15 ohms per square. The dimensions of the mirror assemblies were about 2.5"x10"x53 μm , with a weather barrier of an epoxy resin coupled with spacers of about 53 μm also applied.

We placed into these mirror assemblies the electrochromic monomer composition of Example 15(A), supra, using the vacuum backfilling technique [as described in Varaprasad III, supra].

C. Transformation of Electrochromic Monomer Composition Within Mirror to Polychromatic Solid Film

Once the electrochromic monomer composition of Example 15(A), supra, was uniformly applied within the mirror assemblies of Example 15(B), supra, we placed the assemblies onto the conveyor belt of a Fusion UV Curing System F-300 B, and exposed the assemblies to ultraviolet radiation in the same manner as described in Example 1(D), supra.

D. Use of Electrochromic Mirrors

We applied a potential of about 1.3 volts to one of the mirrors, and thereafter observed that the mirror colored rapidly and uniformly to a blue color with a greenish hue.

In addition, we observed that the high reflectance at the center portion of the mirror was about 82.6% reflectance which decreased to a low reflectance of about 8.8%. The response time for the reflectance to change from about 70% to about 20% was about 2.5 seconds at about room temperature and about the same when the surrounding temperature was reduced to about -28° C. when a potential of about 1.3 volts was applied thereto. We made that determination by the reflectometer described in Example 1, supra.

We also observed that the mirror bleached from about 10% reflectance to about 60% reflectance in a response time of about 1.9 seconds at about room temperature and of about 7.4 seconds when the surrounding temperature was reduced to about -28° C. under about zero applied potential.

Example 16

In this example, we chose to manufacture the polychromic solid film from a commercially available epoxy resin together with a cross-linking agent to illustrate enhanced prolonged coloration performance attained when such combinations are used in the electrochromic monomer composition.

A. Preparation of Electrochromic Monomer Composition

We prepared an electrochromic monomer composition comprising by weight about 4.7% HVBf_4 (as a cathodic compound), about 1.7% ferrocene (as an anodic compound), both homogeneously dispersed in a combination comprising about 64.5% propylene carbonate (as a plasticizer) and about 26.5% "CYRACURE" resin UVR-6105 (as a monomer component) and about 1.2% 2-ethyl-2-(hydroxymethyl)-1,3-propanediol (as a cross-linking agent). We also added about 1.4% "CYRACURE" UVI-6990 (as a photoinitiator), and thoroughly mixed this electrochromic monomer composition to ensure that a homogeneous dispersion of the components was achieved.

B. Mirror Assembly With Electrochromic Monomer Composition

We assembled interior automotive mirrors HWG-ITO coated glass substrates (where the conductive surface of each glass substrate faced one another), with the clear, front glass and silvered, rear glass having a sheet resistance of about 15 ohms per square. The dimensions of the mirror assemblies were about $2.5 \times 10 \times 53$ μm , with a weather barrier of an epoxy resin coupled with spacers of about 53 μm also applied.

We placed into these mirror assemblies the electrochromic monomer composition of Example 16(A), supra, using the vacuum backfilling technique [as described in Varaprasad III, supra].

C. Transformation of Electrochromic Monomer Composition Within Mirror to Polychromic Solid Film

Once the electrochromic monomer composition of Example 16(A), supra, was uniformly applied within the mirror assemblies of Example 16(B), supra, we placed the assemblies onto the conveyor belt of a Fusion UV Curing System F-300 B, and exposed the assemblies to ultraviolet radiation in the same manner as described in Example 1(D), supra.

D. Use of Electrochromic Mirror

We applied a potential of about 1.3 volts to one of the electrochromic mirrors prepared according to Examples 16(B) and (C), supra, and observed this mirror to color rapidly and uniformly to a blue color with a greenish hue.

In addition, we observed that the high reflectance at the center portion of the mirror was about 80.0% reflectance which decreased to a low reflectance of about 7.3% when about 1.3 volts was applied thereto. The response time for the reflectance to change from about 70% to about 20%

when that potential was applied thereto was about 2.9 seconds. We made this determination by the reflectometer described in Example 1, supra.

We also observed that the mirror bleached from about 10% reflectance to about 60% reflectance in a response time of about 3.8 seconds under about a zero applied potential. We noted the bleaching to be uniform.

We further observed that the mirror bleached uniformly and satisfactorily after prolonged coloration in excess of about 8 hours.

Example 17

In this example, like Example 16, we chose to manufacture polychromic solid films from a commercially available epoxy resin together with a cross-linking agent to illustrate enhanced prolonged coloration performance attained when such combinations are used in the electrochromic monomer composition.

A. Preparation of Electrochromic Monomer Composition

We prepared an electrochromic monomer composition according to the present invention comprising about 4.7% HVBf_4 (as a cathodic compound), about 1.4% ferrocene (as an anodic compound), both homogeneously dispersed in a combination of about 64.6% propylene carbonate (as a plasticizer), about 17.5% "CYRACURE" resin UVR-6105 (as a monomer component) and about 10.1% "CARBO-WAX" PEG 1450 (as a cross-linking agent). We also added about 1.4% "CYRACURE" UVI-6990 (as a photoinitiator), and thoroughly mixed this electrochromic monomer composition to ensure that a homogeneous dispersion of the components was achieved.

B. Mirror Assembly with Electrochromic Monomer Composition

We assembled interior automotive mirrors from HWG-ITO coated glass substrates (where the conductive surface of each glass substrate faced one another), with the clear, front glass and the silvered, rear glass having a sheet resistance of about 15 ohms per square. The dimensions of the mirror assemblies were about $2.5 \times 10 \times 53$ μm , with a weather barrier of an epoxy resin coupled with spacers of about 53 μm also applied.

We placed into these mirror assemblies the electrochromic monomer composition of Example 17(A), supra, using the vacuum backfilling technique [as described in Varaprasad III, supra].

C. Transformation of Electrochromic Monomer Composition Within Mirror to Polychromic Solid Film

Once the electrochromic monomer composition of Example 17(A), supra, was uniformly applied within the mirror assemblies of Example 17(B), supra, we placed the assemblies onto the conveyor belt of a Fusion UV Curing System F-300 B, and exposed the assemblies to ultraviolet radiation in the same manner as described in Example 1(D), supra.

D. Use of Electrochromic Mirror

We applied a potential of about 1.3 volts to one of the electrochromic mirrors, and thereafter observed this mirror to color rapidly and uniformly to a blue color with a greenish hue.

In addition, we observed that the high reflectance at the center portion of the mirror was about 75.2% reflectance which decreased to a low reflectance of about 7.6% when about 1.3 volts was applied thereto. The response time for the reflectance to change from about 70% to about 20% when that potential was applied thereto was about 2.4 seconds. We made this determination by the reflectometer described in Example 1, supra.

We also observed that the mirror bleached from about 10% reflectance to about 60% reflectance in a response time of about 4.2 seconds under about a zero applied potential. We noted the bleaching to be uniform.

We further observed that the mirror bleached uniformly and satisfactorily after prolonged coloration in excess of about 8 hours.

Example 18

In this example, we chose ferrocene as the anodic electrochromic compound together with a monomer component containing the combination of a monofunctional monomer and a difunctional monomer to illustrate the beneficial properties and characteristics of polychromic solid films made therefrom.

A. Preparation of Electrochromic Monomer Composition

We prepared an electrochromic monomer composition comprising by weight about 4.3% EVCIO_4 (as a cathodic compound), about 1.9% ferrocene (as an anodic compound), both homogeneously dispersed in a combination comprising about 55.9% propylene carbonate (as a plasticizer) and, in combination as a monomer component, about 12.7% caprolactone acrylate and about 17.2% polyethylene glycol diacrylate (400). We also added about 3.5% benzoin *i*-butyl ether (as a photoinitiator) and about 4.3% "UVINUL" N 35 (as an ultraviolet stabilizing agent), and thoroughly mixed this electrochromic monomer composition to ensure that a homogenous dispersion of the components was achieved.

B. Mirror Assembly With Electrochromic Monomer Composition

We assembled interior automotive mirrors from HWG-ITO coated glass substrates (where the conductive surface of each glass substrate faced one another), with both the clear, front glass and the silvered, rear glass having a sheet resistance of about 15 ohms per square. The dimensions of the mirror assemblies were about $2.5'' \times 10'' \times 44 \mu\text{m}$, with a weather barrier of an epoxy resin coupled with spacers of about $44 \mu\text{m}$ also applied.

We placed into these mirror assemblies the electrochromic monomer composition of Example 18(A), supra, using the vacuum backfilling technique [as described in Varaprasad III, supra].

C. Transformation of Electrochromic Monomer Composition Within Mirror to Polychromic Solid Film

Once the electrochromic monomer composition of Example 18(A), supra, was uniformly applied within the mirror assemblies of Example 18(B), supra, we placed the assemblies onto the conveyor belt of a Fusion UV Curing System F-300 B. While the belt advanced initially at a rate of about fifty feet per minute, we exposed the assemblies to ultraviolet radiation generated by the D fusion lamp of the F-300 B. We passed these mirror assemblies under the fusion

lamp fifteen times pausing for two minute intervals between every third pass, then nine times at that rate pausing for two minute intervals between every third pass, and finally six times at a rate of about twenty-five feet per minute pausing for two minute intervals after every other pass.

D. Use of Electrochromic Mirror

We applied a potential of about 1.5 volts to one of the electrochromic mirrors of Examples 18(B) and (C), supra, and observed this mirror to color rapidly and uniformly to a blue color with a greenish hue.

In addition, we observed that the high reflectance at the center portion of the mirror was about 77.1% reflectance which decreased to a low reflectance of about 7.9% when about 1.5 volts was applied thereto. The response time for the reflectance to change from about 70% to about 20% when that potential was applied thereto was about 2.8 seconds. We made this determination by the reflectometer described in Example 1, supra.

We also observed that the mirror bleached from about 10% reflectance to about 60% reflectance in a response time of about 2.6 seconds under about a zero applied potential. We noted the bleaching to be uniform.

Example 19

In this example, we chose ferrocene as the anodic electrochromic compound together with a monomer component containing the combination of a monomer and a commercially available ultraviolet curable formulation to illustrate the beneficial properties and characteristics of polychromic solid films made therefrom.

A. Preparation of Electrochromic Monomer Composition

We prepared an electrochromic monomer composition comprising by weight about 4.3% EVCIO_4 (as a cathodic compound), about 1.9% ferrocene (as an anodic compound), both homogeneously dispersed in a combination of about 55.9% propylene carbonate (as a plasticizer), and, in combination as a monomer component, about 10.3% caprolactone acrylate, about 15.5% polyethylene glycol diacrylate (400) and about 4.3% "SARBOX" acrylate resin (SB 500). We also added about 3.5% benzoin *i*-butyl ether (as a photoinitiator) and about 4.3% "UVINUL" N 35 (as an ultraviolet stabilizing agent), and thoroughly mixed this electrochromic monomer composition to ensure that a homogeneous dispersion of the components was achieved.

B. Mirror Assembly With Electrochromic Monomer Composition

We assembled interior automotive mirrors with HWG-ITO coated glass substrates (where the conductive surface of each glass substrate faced one another), with both the clear, front glass and the silvered, rear glass having a sheet resistance of about 15 ohms per square. The dimensions of the mirror assemblies were about $2.5'' \times 10'' \times 53 \mu\text{m}$, with a weather barrier of an epoxy resin coupled with spacers of about $53 \mu\text{m}$ also applied.

We placed into these mirror assemblies the electrochromic monomer composition of Example 19(A), supra, using the vacuum backfilling technique [as described in Varaprasad III, supra].

C. Transformation of Electrochromic Monomer Composition Within Mirror to Polychromic Solid Film

Once the electrochromic monomer composition of Example 19(A), supra, was uniformly applied within the

mirror assemblies of Example 19(B), supra, we placed the assemblies onto the conveyor belt of a Fusion UV Curing System F-300 B, and exposed the assemblies to ultraviolet radiation in the same manner as described in Example 18(C), supra.

D. Use of Electrochromic Mirrors

We applied a potential of about 1.5 volts to one of the mirrors, and thereafter observed that the mirror colored rapidly and uniformly to a blue color with a greenish hue.

In addition, we observed that the high reflectance at the center portion of the mirror was about 79.6% reflectance which decreased to a low reflectance of about 7.6%. The response time for the reflectance to change from about 70% to about 20% was about 2.2 seconds when a potential of about 1.5 volts was applied thereto. We made that determination by the reflectometer described in Example 1, supra.

We also observed that the mirror bleached from about 10% reflectance to about 60% reflectance in a response time of about 2.5 seconds under about zero applied potential.

Example 20

In this example, we chose to manufacture interior rearview mirrors from polychromic solid films prepared with a commercially available epoxy resin together with a cross-linking agent to illustrate enhanced prolonged coloration performance attained when such combinations are used in the electrochromic monomer composition.

A. Preparation of Electrochromic Monomer Composition

We prepared an electrochromic monomer composition comprising by weight about 4.6% EVCIO_4 (as a cathodic compound), about 2.1% ferrocene (as an anodic compound), both homogeneously dispersed in a combination comprising about 57.4% propylene carbonate (as a plasticizer) and, in combination as a monomer component, about 8.2% "CYRACURE" resin UVR-6105 and about 14.0 caprolactone, and about 1.1% 2-ethyl-2-(hydroxymethyl)-1,3-propanediol (as a cross-linking agent). We also added, in combination as photoinitiators, about 1.4% "CYRACURE" UVI-6990 and about 1.5% benzoin i-butyl ether, and thoroughly mixed this electrochromic monomer composition to ensure that a homogeneous dispersion of the components was achieved.

B. Mirror Assembly With Electrochromic Monomer Composition

We assembled interior automotive mirrors HWG-ITO coated glass substrates (where the conductive surface of each glass substrate faced one another), with the clear, front glass and the silvered, rear glass having a sheet resistance of about 15 ohms per square. The dimensions of the mirror assemblies were about $2.5 \times 10 \times 44 \mu\text{m}$, with a weather barrier of an epoxy resin coupled with spacers of about $44 \mu\text{m}$ also applied.

We placed into these mirror assemblies the electrochromic monomer composition of Example 20(A), supra, using the vacuum backfilling technique [as described in Varaprasad III, supra].

C. Transformation of Electrochromic Monomer Composition Within Mirror to Polychromic Solid Film

Once the electrochromic monomer composition of Example 20(A), supra, was uniformly applied within the

mirror assemblies of Example 20(B), supra, we placed the assemblies onto the conveyor belt of a Fusion UV Curing System F-300 B, and exposed the assemblies to ultraviolet radiation in the same manner as described in Example 1(D), supra.

D. Use of Electrochromic Mirror

We applied a potential of about 1.4 volts to one of the electrochromic mirrors prepared according to Examples 20(B) and (C), supra, and observed this mirror to color rapidly and uniformly to a blue color with a greenish hue.

In addition, we observed that the high reflectance at the center portion of the mirror was about 76.9% reflectance which decreased to a low reflectance of about 7.9% when about 1.4 volts was applied thereto. The response time for the reflectance to change from about 70% to about 20% when that potential was applied thereto was about 3.1 seconds. We made this determination by the reflectometer described in Example 1, supra.

We also observed that the mirror bleached from about 10% reflectance to about 60% reflectance in a response time of about 3.3 seconds under about a zero applied potential. We noted the bleaching to be uniform.

Example 21

In this example, we illustrate that a prolonged application of a bleach potential—i.e., a potential having a polarity opposite to that used to achieve color—, having a magnitude greater than about 0.2 volts, and preferably about 0.4 volts, may be used to enhance bleach speeds of electrochromic devices, such as automotive rearview mirrors, manufactured with polychromic solid films as the medium of variable reflectance.

A. Preparation of Electrochromic Monomer Composition

We prepared an electrochromic monomer composition comprising by weight about 4.30% EVCIO_4 (as a cathodic compound), about 1.9% ferrocene (as an anodic compound), both homogeneously dispersed in a combination comprising about 60.2% propylene carbonate (as a plasticizer) and, in combination as a monomer component, about 8.6% caprolactone acrylate, about 12.9% polyethylene glycol diacrylate (400) and about 4.3% "SARBOX" acrylate resin (SB 500). We also added about 3.4% "IRGACURE" 184 (as a photoinitiator) and about 4.3% "UVINUL" N 35 (as an ultraviolet stabilizing agent), and thoroughly mixed this electrochromic monomer composition to ensure that a homogeneous dispersion of the components was achieved.

B. Mirror Assembly With Electrochromic Monomer Composition

We assembled interior automotive mirrors from HW-ITO coated glass substrates (where the conductive surface of each glass substrate faced one another), with both the front, clear glass and the silvered, rear glass having a sheet resistance of about 15 ohms per square. The dimensions of the mirror assemblies were about $2.5 \times 10 \times 44 \mu\text{m}$, with a weather barrier of an epoxy resin coupled with spacers of about $44 \mu\text{m}$ also applied.

We placed into these mirror assemblies the electrochromic monomer composition of Example 21(A), supra, using the vacuum backfilling technique [as described in Varaprasad III, supra].

C. Transformation of Electrochromic Monomer Composition Within Mirror to Polychromic Solid Film

Once the electrochromic monomer composition of Example 21(A), supra, was uniformly applied within the

mirror assemblies of Example 21(B), supra, we placed the assemblies onto the conveyor belt of a Fusion UV Curing System F-300 B, and exposed the assemblies to ultraviolet radiation in the same manner as described in Example 1(D), supra.

D. Use of Electrochromic Mirror

We applied a potential of about -0.7 volts to one of the electrochromic mirrors of Examples 21(B) and (C), supra, and observed that mirror reflectance at the center portion of the mirror remained high at about 76%.

Upon reversing the polarity of the applied potential and increasing the magnitude to about +1.5 volts, we observed this mirror to color rapidly and uniformly to a blue color.

In addition, we observed that the high reflectance at the center portion of the mirror decreased to a low reflectance of about 7.8%, with the response time for the reflectance to change from about 70% to about 20% when that potential was applied thereto being about 2.4 seconds. We made this determination by the reflectometer described in Example 1, supra.

We also observed that the mirror bleached from about 10% reflectance to about 60% reflectance in a response time of about 1.7 seconds under a potential of about -0.7 volts with a high reflectance of about 78% re-established. We noted that when a potential of about zero volts to about -0.2 volts was applied to the mirror to bleach the mirror from the fully dimmed state, the response time to achieve this effect was about 2.0 seconds. We also noted that when a potential having a greater magnitude, such as about -0.8 volts to about -0.9 volts, was applied to the mirror, the color assumed by the polychromic solid film may be controlled. For instance, a slight blue tint may be achieved at that aforesaid greater negative potential using the electrochromic system of this example so that the bleached state of the electrochromic mirror may be matched to the color appearance of conventional non-electrochromic blue-tint mirrors commonly featured on luxury automobiles.

Example 22

In this example, we illustrate that a gradient opacity panel, such as that which may be used as an electrochromic shade band on an automobile windshield, may be created by configuring the bus bars on the electrochromic assembly so they are affixed partially around, or along the opposite sides, of the assembly, thus creating a transition between the areas of the device to which voltage is applied and those where no voltage is applied.

A. Preparation of Electrochromic Monomer Composition

We prepared an electrochromic monomer composition comprising by weight about 2.1% EVCIO_4 (as a cathodic compound), about 1.4% t-butyl ferrocene (as an anodic compound), both homogeneously dispersed in a combination of about 54.2% propylene carbonate (as the plasticizer), and, in combination as a monomer component, about 28.6% B-565 and about 13.8% Urethane Acrylate (Soft) (CN 953). We thoroughly mixed this electrochromic monomer composition to ensure that a homogeneous dispersion of the components was achieved.

B. Panel Assembly With Electrochromic Monomer Composition

We constructed a panel assembly containing an electrochromic shade band by dispensing a portion of the electro-

chromic monomer composition of Example 22(A), supra, onto the conductive surface of a HW-ITO coated glass substrate having a sheet resistance of about 15 ohms per square. Onto this substrate we also placed 100 μm glass beads, and then positioned thereover another HW-ITO coated glass substrate having a sheet resistance of about 15 ohms per square so that the electrochromic monomer composition was between and in contact with the conductive surface of the two glass substrates. The dimensions of the assembly were about 4.5" x 14", with an interpane distance between the glass substrates of about 100 μm .

We connected bus bars along the 14" sides of the panel assembly only about 4" inward from the edge of each of the opposing 14" sides. We thereafter affixed electrical leads to the bus bars.

C. Transformation of Electrochromic Monomer Composition Within Panel Assembly to Polychromic Solid Film

Once the electrochromic monomer composition of Example 22(A), supra, was uniformly applied within the window panel assembly of Example 22(B), supra, we placed the assembly onto the conveyor belt of a Fusion UV Curing System F-300 B, and exposed the panel assembly to ultraviolet radiation in the same manner as described in Example 2(C), supra.

Once the polychromic solid film was formed, we applied a weather barrier of epoxy resin along, and over, the glass joints to prevent entry of environmental contaminants. This weather barrier consisted of a bead of "ENVIBAR" UV 1244 ultraviolet curable adhesive followed by the application of "SMOOTH-ON" room temperature cure epoxy (commercially available from Smooth-On Inc., Gillette, N.J.).

D. Demonstration of Electrochromic Shade Band Within Panel Assembly

We applied a potential of about 1.3 volts to the panel assembly, and thereafter observed that only the 4" region through which an electric field was formed colored rapidly, uniformly and intensely to a blue color. We also observed that color extended beyond that 4" region for a distance of about 1" in a gradient opacity which changed gradually from an intense coloration immediately adjacent the bus bar/non-bus bar transition to a bleached appearance beyond that additional 1" region or thereabouts.

In addition, we observed that the high transmittance at the center portion of the panel assembly was about 79.6% transmittance which decreased to a low transmittance of about 7.6%. The response time for the transmittance to change from about 70% to about 20% was about 2.2 seconds when a potential of about 1.5 volts was applied thereto. We made that determination by the reflectometer described in Example 1, supra, except that the reflectometer was set in transmission mode.

We also observed that the panel assembly bleached from about 10% transmittance to about 60% transmittance in a response time of about 2.5 seconds under about zero applied potential.

Example 23

In this example, like Example 3, supra, we installed the interior automotive mirror as a rearview mirror in an automobile to observe its performance under conditions attendant with actual use.

79

A. Preparation of Electrochromic Monomer Composition

We prepared an electrochromic monomer composition comprising by weight about 3.0% EVCIO_4 (as a cathodic compound), about 1.3% ferrocene (as an anodic compound), both homogeneously dispersed in a combination of about 62.6% propylene carbonate (as a plasticizer), and, in combination as a monomer component, about 8.9% caprolactone acrylate, about 13.4% polyethylene glycol diacrylate (400) and about 4.5% "SARBOX" acrylate resin (SB 500). We also added about 1.8% "IRGACURE" 184 (as a photoinitiator) and about 4.5% "UVINUL" N 35 (as an ultraviolet stabilizing agent), and thoroughly mixed this electrochromic monomer composition to ensure that a homogeneous dispersion of the components was achieved.

B. Mirror Assembly With Electrochromic Monomer Composition

We assembled an interior automotive mirror with HWG-ITO coated glass substrates (where the conductive surface of each glass substrate faced one another), with both the clear, front glass and the silvered, rear glass having a sheet resistance of about 15 ohms per square. The dimensions of the mirror assemblies were about $2.5" \times 10" \times 74 \mu\text{m}$, with a weather barrier of an epoxy resin coupled with spacers of about $74 \mu\text{m}$ also applied.

We placed into these mirror assemblies the electrochromic monomer composition of Example 23(A), supra, using the vacuum backfilling technique [as described in Varaprasad III, supra].

C. Transformation of Electrochromic Monomer Composition Within Mirror to Polychromic Solid Film

Once the electrochromic monomer composition of Example 23(A), supra, was uniformly applied within the mirror assembly of Example 23(B), supra, we placed the assembly onto the conveyor belt of a Fusion UV Curing System F-300 B, and exposed the assembly to ultraviolet radiation in the same manner as described in Example 1(D), supra.

D. Use of Electrochromic Mirror

We applied a potential of about 1.5 volts to the mirror, and thereafter observed rapid and uniform coloration to a blue color with a greenish hue.

In addition, we observed that the high reflectance at the center portion of the mirror was about 72.0% reflectance which decreased to a low reflectance of about 7.5%. The response time for the reflectance to change from about 70% to about 20% was about 3.5 seconds when a potential of about 1.5 volts was applied thereto. We made that determination by the reflectometer described in Example 1, supra.

We also observed that the mirror bleached from about 10% reflectance to about 60% reflectance in a response time of about 5.2 seconds under about zero applied potential.

We have successfully installed and operated this mirror in an automobile as a rearview mirror and have achieved excellent results.

Example 24

In this example, we chose to illustrate the beneficial properties and characteristics of polychromic solid films manufactured within an electrochromic sun roof panel.

80

A. Preparation of Electrochromic Monomer Composition

We prepared an electrochromic monomer composition according to the present invention comprising about 1.4% EVCIO_4 (as a cathodic compound), about 0.9% *t*-butyl ferrocene (as an anodic compound), both homogeneously dispersed in a combination comprising about 39% propylene carbonate (as a plasticizer), and, in combination as a monomer component, about 39% "quick CURE" B-565 and about 19.53% Urethane Acrylate (Soft) (CN 953). We thoroughly mixed this electrochromic monomer composition to ensure that a homogeneous dispersion of the components was achieved.

B. Preparation of Sun Roof Panel Assembly and Placement of Electrochromic Monomer Composition Therein

We prepared the glass substrates for use in the glazing assembly of this example by placing flat "TEC-20" glass substrates (with a black ceramic frit band around their perimeter edge regions), having dimensions of about $12" \times 16"$, onto the mold of a bending instrument at room temperature under ambient conditions, and then increasing the temperature of the substrates to be bent to at least about 500°C , thereby causing the substrates to conform to the shape of the mold.

We also placed, as a spacer means, black drafting tape (Zipatone, Inc., Hillsdale, Ill.), having a width of about 0.0625" and a thickness of about $150 \mu\text{m}$, onto a conductive surface of one of the bent "TEC-20" glass substrates in about 1.5" intervals across the width of the substrate. At such intervals, we found the black drafting tape to be positioned in an aesthetically appealing manner, and to maintain uniformity of the electrochromic media across the full dimensions of the panel.

We assembled the sun roof panel by dispensing a portion of the electrochromic monomer composition of Example 24(A), supra, onto the conductive surface of the substrate to be used as the concave interior surface (i.e., the Number 4 surface), and placed thereover the conductive surface of the substrate bearing the spacer means so that the electrochromic monomer composition was between and in contact with the conductive surface of the glass substrates. We then placed the panel assembly in a vacuum bag, gently elevated the temperature and evacuated substantially most of the air from the vacuum bag. In this way, the electrochromic monomer composition dispersed uniformly between the substrates under the pressure from the atmosphere.

C. Transformation of Electrochromic Monomer Composition Into Polychromic Solid Film

We then placed the sun roof panel assembly (still contained in the vacuum bag) into a Sunlighter model 1530 UV chamber, equipped with three mercury lamps (commercially available from Test-Lab Apparatus Co., Milford, N.H.), and allowed the sun roof panel to remain exposed to the ultraviolet radiation emitted by the lamps for a period of time of about 30 minutes. The interpane distance between the "TEC-20" glass substrates was about $150 \mu\text{m}$.

We thereafter attached bus bars at the 12" side of the substrates to create a distance therebetween of about 16". We then attached electrical leads to the bus bars.

D. Use of Electrochromic Sun Roof Panel

We applied a potential of about 1.3 volts to the glazing assembly, and thereafter observed the panel to color rapidly and uniformly to a bluish purple color.

In addition, we observed that the high transmission at the center portion of the sun roof panel was about 67% transmission which decreased to a low transmission of about 5% when about 1.3 volts was applied thereto. The response time for the transmission to change from about 60% to about 10% when that potential was applied thereto was about 3 minutes. We made this determination by the detection method described in Example 1, supra, except that the reflectometer was set in transmission mode.

We also observed that the glazing assembly bleached from about 5% transmission to about 60% transmission in a response time of about 6.5 minutes under about a zero applied potential.

The ultraviolet stability, scatter safety performance and/or electrochromic performance, and reduction in transmittance of near-infrared radiation of sun roof panels manufactured in accordance with the teaching herein, may be augmented by using the methods taught in Lynam III and Lynam V, and in commonly assigned U.S. Pat. No. 5,239,406 (Lynam)].

Example 25

In this example, we chose to illustrate the beneficial properties and characteristics of polychromic solid films manufactured within an electrochromic sun visor having a segmented design.

A. Preparation of Electrochromic Monomer Composition

We prepared an electrochromic monomer composition according to the present invention comprising about 2.4% EVCIO_4 (as a cathodic compound), about 1.6% ferrocene (as an anodic compound), both homogeneously dispersed in a combination comprising about 48% propylene carbonate (as a plasticizer), and, in combination as a monomer component, about 32% "quick CURE" B-565 and about 16% Urethane Acrylate (Soft) (CN 953). We thoroughly mixed this electrochromic monomer composition to ensure that a homogeneous dispersion of the components was achieved.

B. Sun Visor with Electrochromic Monomer Composition

We assembled the sun visor of this example from FW-ITO coated glass substrates, having dimensions of about 4"×14" and a sheet resistance of about 6 to about 8 ohms per square, onto which we previously placed deletion lines to form three individual segments. We created these deletion lines by screening a photo-resist material onto the glass substrate prior to depositing the ITO coating, and thereafter applying a coat of ITO onto the photo-resist coated substrate, and washing away the photoetched resist material using an organic solvent, such as acetone.

We assembled the sun visor by placing onto the 14" edges of the conductive surface of one of the FW-ITO glass substrates "KAPTON" high temperature polyamide tape (E. I. du Pont de Nemours and Company, Wilmington, Del.), having a thickness of 70 μm . We then dispensed a portion of the electrochromic monomer composition of Example 25(A), supra, onto that conductive surface and then placed thereover the conductive surface of another substrate so that the electrochromic monomer composition was between and in contact with the conductive surface of the glass substrates. The interpane distance between the substrates was about 70 μm .

C. Transformation of Electrochromic Monomer Composition Within Sun Visor to Polychromic Solid Film

Once the electrochromic monomer composition of Example 25(A), supra, was uniformly applied within the sun

visor assembly of Example 25(B), supra, we placed the assembly onto the conveyor belt of a Fusion UV Curing System F-300 B, and exposed the assembly to ultraviolet radiation in the same manner as described in Example 2(C), supra.

Upon completion of the transformation process, we applied "ENVIBAR" UV 1244 to the glass edges and joints and again exposed the sun visor to ultraviolet radiation to further weather barrier protect the sun visor. We then applied "SMOOTH-ON" epoxy to those portions of the sun visor to form a final weather barrier about the sun visor.

D. Use of Electrochromic Sun Visor

We applied a potential of about 1.3 volts to the sun visor, and thereafter observed the sun visor to color rapidly and uniformly to a bluish purple color.

In addition, we observed that the high transmission at the center portion of the sun visor was about 74.9% transmission which decreased to a low transmission of about 2.5% when about 1.5 volts was applied thereto. The response time for the transmission to change from the high transmission state to about 10% when that potential was applied thereto was about 9 seconds. We made this determination by the detection method described in Example 1, supra, except that the reflectometer was set in transmission mode.

We also observed that the sun visor bleached from about 10% transmission to about 70% transmission in a response time of about 15 seconds under about a zero applied potential.

The segmented portions of the sun visor of this example may be made in a horizontal direction or a vertical direction, and individual segments may be activated by connection to an individual segment addressing means, such as a mechanical switch, a photosensor, a touch sensor, including a touch activated glass panel, a voice activated sensor, an RF activated sensor and the like. In addition, segments may be activated individually or as pluralities by responding to glare from the sun, such as when the sun rises from and falls toward the horizon, or as it traverses the horizon. This sun visor, as well as other electrochromic glazings, such as windows, sun roofs and the like, may use automatic glare sensing means that involve single or multiple photosensors, such as those disclosed in U.S. Pat. No. 5,148,014 (Lynam).

Example 26

In this example, we assembled an interior automotive mirror as a rearview mirror to be installed in an automobile to observe its performance under conditions attendant with actual use.

A. Preparation of Electrochromic Monomer Composition

We prepared an electrochromic monomer composition comprising by weight about 3.6% EVCIO_4 (as a cathodic compound), about 1.6% ferrocene (as an anodic compound), both homogeneously dispersed in a combination of about 61.9% propylene carbonate (as a plasticizer), and, in combination as a monomer component, about 11.1% polyethylene glycol monomethacrylate (400), about 11.1% polyethylene glycol diacrylate (400) and about 4.4% "SARBOX" acrylate resin (SB 500). We also added about 1.8% "IRGACURE" 184 (as a photoinitiator) and about 4.4% "UVINUL" N 35 (as an ultraviolet stabilizing agent), and thoroughly mixed this electrochromic monomer composition to ensure that a homogeneous dispersion of the components was achieved.

B. Mirror Assembly With Electrochromic Monomer Composition

We assembled an interior automotive mirror with HWG-ITO coated glass substrates (where the conductive surface of each glass substrate faced one another), with both the clear, front glass and the silvered, rear glass having a sheet resistance of about 15 ohms per square. The dimensions of the mirror assemblies were about 2.5"×10"×53 μm, with a weather barrier of an epoxy resin coupled with spacers of about 53 μm also applied.

We placed into these mirror assemblies the electrochromic monomer composition of Example 26(A), supra, using the vacuum backfilling technique [as described in Varaprasad III, supra].

C. Transformation of Electrochromic Monomer Composition Within Mirror to Polychromic Solid Film

Once the electrochromic monomer composition of Example 26(A), supra, was uniformly applied within the mirror assembly of Example 26(B), supra, we placed the assembly onto the conveyor belt of a Fusion UV Curing System F-300 B, and exposed the assembly to ultraviolet radiation in the same manner as described in Example 1(D), supra.

D. Use of Electrochromic Mirror

We applied a potential of about 1.5 volts to the mirror, and thereafter observed rapid and uniform coloration to a blue color with a greenish hue.

In addition, we observed that the high reflectance at the center portion of the mirror was about 72.0% reflectance which decreased to a low reflectance of about 7.4%. The response time for the reflectance to change from about 70% to about 20% was about 2.1 seconds when a potential of about 1.5 volts was applied thereto. We made that determination by the reflectometer described in Example 1, supra.

We also observed that the mirror bleached from about 10% reflectance to about 60% reflectance in a response time of about 4.0 seconds under about zero applied potential.

Example 27

In this example, we assembled automotive mirrors for use with the 1993 Lincoln Continental automobile. Specifically, Example 27(A), infra, illustrates the manufacture and use of an interior rearview mirror, and Example 27(B), infra, illustrates the use of an exterior mirror, sized for driver-side and passenger-side applications, to be installed in the automobile.

A. 1993 Lincoln Continental Interior Rearview Mirror

1. Preparation of Electrochromic Monomer Composition

We prepared an electrochromic monomer composition comprising by weight about 3.6% EVCIO_4 (as a cathodic compound), about 1.6% ferrocene (as an anodic compound), both homogeneously dispersed in a combination of about 62% propylene carbonate (as a plasticizer), and, in combination as a monomer component, about 8.9% caprolactone acrylate, about 13.3% polyethylene glycol diacrylate (400) and about 4.4% "SARBOX" acrylate resin (SB 500). We also added about 1.8% "IRGACURE" 184 (as a

photoinitiator) and about 4.4% "UVINUL" N 35 (as an ultraviolet stabilizing agent), and thoroughly mixed this electrochromic monomer composition to ensure that a homogeneous dispersion of the components was achieved.

2. Interior Rearview Mirror Assembly With Electrochromic Monomer Composition

We assembled an interior rearview mirror, with an interpane distance of 53 μm, from HWG-ITO coated 093 glass substrates (where the conductive surface of each glass substrate faced one another), with both the clear, front glass and the silvered, rear glass having a sheet resistance of about 15 ohms per square. We also applied a weather barrier of an epoxy resin coupled with spacers of about 53 μm.

We placed into these mirror assemblies the electrochromic monomer composition of Example 27(A)(1), supra, using the vacuum backfilling technique [as described in Varaprasad III, supra].

3. Transformation of Electrochromic Monomer Composition Within Mirror to Polychromic Solid Film

Once the electrochromic monomer composition of Example 27(A)(1), supra, was uniformly applied within the mirror assembly of Example 27(A)(2), supra, we placed the assembly onto the conveyor belt of a Fusion UV Curing System F-300 B, and exposed the assembly to ultraviolet radiation in the same manner as described in Example 1(D), supra.

4. Use of Electrochromic Mirror

We applied a potential of about 1.5 volts to the mirror, and thereafter observed rapid and uniform coloration to a blue color with a greenish hue.

In addition, we observed that the high reflectance at the center portion of the mirror was about 76.5% reflectance which decreased to a low reflectance of about 7.4%. The response time for the reflectance to change from about 70% to about 20% was about 2.2 seconds when a potential of about 1.5 volts was applied thereto. We made that determination by the reflectometer described in Example 1, supra.

We also observed that the mirror bleached from about 10% reflectance to about 60% reflectance in a response time of about 2.7 seconds under about zero applied potential.

B. 1993 Lincoln Continental Exterior Mirrors—Driver-Side and Passenger-Side

1. Preparation of Electrochromic Monomer Composition

We prepared an electrochromic monomer composition comprising by weight about 2.6% EVCIO_4 (as a cathodic compound), about 1.2% ferrocene (as an anodic compound), both homogeneously dispersed in a combination of about 63% propylene carbonate (as a plasticizer), and, in combination as a monomer component, about 9% caprolactone acrylate, about 13.5% polyethylene glycol diacrylate (400) and about 4.5% "SARBOX" acrylate resin (SB 500). We also added about 1.8% "IRGACURE" 184 (as a photoinitiator) and about 4.5% "UVINUL" N 35 (as an ultraviolet stabilizing agent), and thoroughly mixed this electrochromic monomer composition to ensure that a homogeneous dispersion of the components was achieved.

2. Exterior Mirror Assemblies With Electrochromic Monomer Composition

We assembled exterior mirrors, with an interpane distance of 74 μm, from FW-ITO coated 063 glass substrates (where

85

the conductive surface of each glass substrate faced one another), with both the clear, front glass and the silvered, rear glass having a sheet resistance of about 6 to about 8 ohms per square. We also applied a weather barrier of an epoxy resin coupled with spacers of about 74 μm .

We placed into these mirror assemblies the electrochromic monomer composition of Example 27(B)(1), supra, using the vacuum backfilling technique [as described in Varaprasad III, supra].

3. Transformation of Electrochromic Monomer Composition Within Mirror to Polychromic Solid Film

Once the electrochromic monomer composition of Example 27(B)(1), supra, was uniformly applied within the mirror assemblies of Example 27(B)(2), supra, we placed the assemblies onto the conveyor belt of a Fusion UV Curing System F-300 B, and exposed the assemblies to ultraviolet radiation in the same manner as described in Example 1(D), supra.

4. Use of Electrochromic Mirrors

We applied a potential of about 1.5 volts to one of the mirrors, and thereafter observed rapid and uniform coloration to a blue color with a greenish hue.

In addition, we observed that the high reflectance at the center portion of the mirror was about 72% reflectance which decreased to a low reflectance of about 8%. The response time for the reflectance to change from about 70% to about 20% was about 3.9 seconds when a potential of about 1.5 volts was applied thereto. We made that determination by the reflectometer described in Example 1, supra.

We also observed that the mirror bleached from about 10% reflectance to about 60% reflectance in a response time of about 4.0 seconds under about zero applied potential.

Example 28

A. Preparation of Electrochromic Monomer Composition

We prepared an electrochromic monomer composition comprising by weight about 6.31% HVSS (as a cathodic compound), about 1.63% ferrocene (as an anodic compound), both homogeneously dispersed in a combination of about 47.48% propylene carbonate and about 8.63% 3-hydroxypropionitrile (as a plasticizer), and, in combination as a monomer component, about 12.95% caprolactone acrylate, about 8.63% polyethylene glycol diacrylate (400) and about 8.63% "SARBOX" acrylate resin (SB 501). We also added, in combination as photoinitiators, about 0.13% "IRGACURE" 184 and about 1.29% "CYRACURE" UVI-6990 and about 4.32% "UVINUL" N 35 (as an ultraviolet stabilizing agent), and thoroughly mixed this electrochromic monomer composition to ensure that a homogeneous dispersion of the components was achieved.

B. Mirror Assembly With Electrochromic Monomer Composition

We assembled an interior rearview mirror, with an inter-pane distance of 53 μm , from HWG-ITO coated 093 glass substrates (where the conductive surface of each glass substrate faced one another), with both the clear, front glass and the silvered, rear glass having a sheet resistance of about 15 ohms per square. We also applied a weather barrier of an epoxy resin coupled with spacers of about 53 μm .

86

We placed into these mirror assemblies the electrochromic monomer composition of Example 28(A), supra, using the vacuum backfilling technique [as described in Varaprasad III, supra].

C. Transformation of Electrochromic Monomer Composition Within Mirror to Polychromic Solid Film

Once the electrochromic monomer composition of Example 28(A), supra, was uniformly applied within the mirror assembly of Example 28(B), supra, we placed the assembly onto the conveyor belt of a Hanovia UV Curing System (Hanovia Corp., Newark, N.J.), fitted with UV lamp 6506A431, with the intensity dial set at 300 watts. We exposed the assembly to ultraviolet radiation in a similar manner as described in Example 1(D), supra, by passing the assembly under the UV lamp with the conveyor speed set at about 20% to about 50% for about 120 to about 180 multiple passes.

D. Use of Electrochromic Mirror

We applied a potential of about 1.2 volts to the mirror, and thereafter observed rapid and uniform coloration to a blue color with a greenish hue.

In addition, we observed that the high reflectance at the center portion of the mirror was about 73.9% reflectance which decreased to a low reflectance of about 7.4%. The response time for the reflectance to change from about 70% to about 20% was about 3.9 seconds when a potential of about 1.2 volts was applied thereto. We made that determination by the reflectometer described in Example 1, supra.

Example 29

A. Preparation of Electrochromic Monomer Composition

We prepared an electrochromic monomer composition comprising by weight about 4.38% DSMVClO₄ (as a cathodic compound) and about 0.57% EHPVClO₄ (as a cathodic compound), about 1.62% ferrocene (as an anodic compound), both homogeneously dispersed in a combination of about 56.74% propylene carbonate (as a plasticizer), and, in combination as a monomer component, about 13.10% caprolactone acrylate, about 8.73% polyethylene glycol diacrylate (400), about 4.37% "SARBOX" acrylate resin (SB 500E50) and about 4.37% "CYRACURE" resin UVR-6110. We also added, in combination as photoinitiators, about 0.44% "IRGACURE" 184 and about 1.31% "CYRACURE" UVI-6990 and about 4.37% "UVINUL" N 35 (as an ultraviolet stabilizing agent), and thoroughly mixed this electrochromic monomer composition to ensure that a homogeneous dispersion of the components was achieved.

B. Mirror Assembly With Electrochromic Monomer Composition

We assembled an interior rearview mirror, with an inter-pane distance of 53 μm , from HWG-ITO coated 093 glass substrates (where the conductive surface of each glass substrate faced one another), with both the clear, front glass and the silvered, rear glass having a sheet resistance of about 15 ohms per square. We also applied a weather barrier of an epoxy resin coupled with spacers of about 53 μm .

We placed into these mirror assemblies the electrochromic monomer composition of Example 29(A), supra, using

the vacuum backfilling technique [as described in Varasprad III, supra].

C. Transformation of Electrochromic Monomer Composition Within Mirror to Polychromic Solid Film

Once the electrochromic monomer composition of Example 29(A), supra, was uniformly applied within the mirror assembly of Example 29(B), supra, we placed the assembly onto the conveyor belt of a Hanovia UV Curing System (Hanovia Corp., Newark, N.J., fitted with UV lamp 6506A431, with the intensity dial set at 300 wats. We exposed the assembly to ultraviolet radiation in a similar manner as described in Example 1(D), supra, by passing the assembly under the UV lamp with the conveyor speed set at about 20% to about 50% for about 120 to about 180 multiple passes.

D. Use of Electrochromic Mirror

We applied a potential of about 1.2 volts to the mirror, and thereafter observed rapid and uniform coloration to a blue color with a greenish hue.

In addition, we observed that the high reflectance at the center portion of the mirror was about 79.6% reflectance which decreased to a low reflectance of about 6.7%. The response time for the reflectance to change from about 70% to about 20% was about 2.8 seconds when a potential of about 1.2 volts was applied thereto. We made that determination by the reflectometer described in Example 1, supra.

Example 30

A. Preparation of Electrochromic Monomer Composition

We prepared an electrochromic monomer composition comprising by weight about 4.42% DSMVClO₄ (as a cathodic compound) and about 0.59% EHPVClO₄ (as a cathodic compound), about 1.65% ferrocene (as an anodic compound), both homogeneously dispersed in a combination of about 48.67% propylene carbonate (as a plasticizer), and, in combination as a monomer component, about 13.27% caprolactone acrylate, about 8.85% polyethylene glycol diacrylate (400), about 8.85% "SARBOX" acrylate resin (SB 500E50) and about 8.85% "CYRACURE" resin UVR-6110. We also added, in combination as photoinitiators, about 0.44% "IRGACURE" 184 and about 1.77% "CYRACURE" UVI-6990 and about 2.65% 2-hydroxy-4-octoxybenzophenone (as an ultraviolet stabilizing agent), and thoroughly mixed this electrochromic monomer composition to ensure that a homogeneous dispersion of the components was achieved.

B. Mirror Assembly With Electrochromic Monomer Composition

We assembled an interior rearview mirror, with an interpane distance of 53 μ m, from HWG-ITO coated 093 glass substrates (where the conductive surface of each glass substrate faced one another), with both the clear, front glass and the silvered, rear glass having a sheet resistance of about 15 ohms per square. We also applied a weather barrier of an epoxy resin coupled with spacers of about 53 μ m.

We placed into these mirror assemblies the electrochromic monomer composition of Example 30(A), supra, using the vacuum backfilling technique [as described in Varasprad III, supra].

C. Transformation of Electrochromic Monomer Composition Within Mirror to Polychromic Solid Film

Once the electrochromic monomer composition of Example 30(A), supra, was uniformly applied within the mirror assembly of Example 30(B), supra, we placed the assembly onto the conveyor belt of a Hanovia UV Curing System (Hanovia Corp., Newark, N.J., fitted with UV lamp 6506A431, with the intensity dial set at 300 wats. We exposed the assembly to ultraviolet radiation in a similar manner as described in Example 1(D), supra, by passing the assembly under the UV lamp with the conveyor speed set at about 20% to about 50% for about 120 to about 180 multiple passes.

D. Use of We applied a poterror

We applied a potential of about 1.3 volts to the mirror, and thereafter observed rapid and uniform coloration to a blue color with a greenish hue.

In addition, we observed that the high reflectance at the center portion of the mirror was about 71.9% reflectance which decreased to a low reflectance of about 6.9%. The response time for the reflectance to change from about 70% to about 20% was about 3.9 seconds when a potential of about 1.3 volts was applied thereto. We made that determination by the reflectometer described in Example 1, supra.

Example 31

A. Preparation of Electrochromic Monomer Composition

We prepared an electrochromic monomer composition comprising by weight about 0.36% HUVPF₆ (as a cathodic compound), about 0.97% EVClO₄ (as a cathodic compound), about 0.17% Ferrocene (FE, an anodic compound), about 0.39% 5,10-dihydro-5,10-dimethylphenazine (as an anodic compound), all homogeneously dispersed in a combination of about 89.68% propylene carbonate (as plasticizer) and, in combination as a monomer component, about 0.65% HDT (an isocyanate) and about 3.08% Lexorez 1931-50 (a polyol), and about 0.03% T-1 (a tin catalyst), and about 4.67% Uvinul N 35 (a UV stabilizer). We thoroughly mixed this monomer composition to ensure that a homogeneous dispersion of the components was achieved.

B. Mirror assembly with Electrochromic Monomer Composition

In this example, we assembled interior automotive mirrors from TEC-15 glass substrates (where the conductive surface of each glass substrate faced one another), with both the clear, front glass and the silvered, rear glass having a sheet resistance of about 15 ohms per square. The dimensions of the mirror assemblies were about 2.5" x 10" x 125 μ m, with a weather barrier of an epoxy resin coupled with spacers of about 125 μ m also applied.

We placed into these mirror assemblies the electrochromic monomer composition of Example 31(A), supra, using the vacuum back filling technique (as described in Varasprad III supra).

C. Transformation of Electrochromic Monomer Composition within Mirror to Polychromic Solid Film

Once the electrochromic monomer composition of Example 31(A), supra, was uniformly applied within the

mirror assemblies of Example 31(B), supra, we placed the assemblies overnight at room temperature during which time the monomer composition reacted to form in situ the solid polymer matrix film inside the mirror. These mirror assemblies were then placed in an electrically heated convection oven maintained at about 80° C. for about 2 hours.

D. Use of Electrochromic Mirror

We applied a potential of about 1.4 volts to one of the electrochromic mirrors, and observed this mirror to color rapidly and uniformly to a gray color with bluish hue.

In addition, we observed that the high reflectance at the center portion of the mirror was about 72.3% reflectance which decreased to a low reflectance of about 7.1% when about 1.4 volts was applied to thereto. The response time for reflectance to change from about 70% to about 20% when that potential was applied thereto was about 2.1 seconds. We made this determination by the reflectometer described in Example 1, supra.

We also observed that the mirror bleached from about 10% reflectance to about 60% reflectance in a response time of about 7.0 seconds under about a zero applied potential. We noted the bleaching to be uniform.

Example 32

A. Preparation of Prepolymer Composition that includes a Viologen containing Polyol

We prepared viologen containing polyol through copolymerization of ESMVCl₄ with caprolactone acrylate according to the following procedure: We prepared a reaction mixture comprising by weight about 4.86% ESMVClO₄ (a viologen with vinyl functionality), about 1.94% UVI 6990 (a photoinitiator), about 0.97% Irgacure 184 (a photoinitiator), all homogeneously dispersed in a combination comprising about 43.69% caprolactone acrylate (an acrylate with hydroxyl functionality) and 48.54% propylene carbonate and placed it in a sealed glass container. We placed the sealed glass container on a conveyor belt of a Fusion UV Curing System F-300B. While the belt advanced at a rate of about 10 feet per minute, we exposed the reaction mixture to ultraviolet radiation generated by the D fusion lamp of the F 300B. We passed the sealed glass container containing the reaction mixture under the fusion lamp light twenty five times at that rate, pausing momentarily between the passes to allow the prepolymer composition to cool. We used the resulting prepolymer composition that includes a viologen containing polyol to prepare the electrochromic monomer composition.

B. Preparation of Electrochromic Monomer Composition

We prepared an electrochromic monomer composition comprising by weight about 2.11% prepolymer composition of Example 32(A), supra (as a cathodic compound and polyol), about 1.97% EVClO₄ (as a cathodic compound), and about 1.01% 5,10-dihydro-5,10-dimethylphenazine (as an anodic compound), all homogeneously dispersed in a combination of about 76.65% propylene carbonate (as plasticizer) and in combination as a monomer component, about 2.68% HDT (an isocyanate) and about 15.52% Desmophen 1700 (a polyol), and about 0.06% T-9 (a tin catalyst). We thoroughly mixed this monomer composition to ensure that a homogeneous dispersion of the components was achieved.

C. Mirror assembly with Electrochromic Monomer Composition

In this example, we assembled interior automotive mirrors from TEC-15 glass substrates (where the conductive

surface of each glass substrate faced one another), with both the clear, front glass and the silvered, rear glass having a sheet resistance of about 15 ohms per square. The dimensions of the mirror assemblies were about 2.5"×10"×105 μm, with a weather barrier of an epoxy resin coupled with spacers of about 105 μm also applied.

We placed into these mirror assemblies the electrochromic monomer composition of Example 32(B), supra, using the vacuum back filling technique (as described in Varaprasad III, supra).

D. Transformation of Electrochromic Monomer Composition within Mirror to Polychromatic Solid Film

Once the electrochromic monomer composition of Example 32(B), supra, was uniformly applied within the mirror assemblies of Example 32 (C), supra, we placed the assemblies overnight at room temperature during which time the monomer composition reacted to form in situ the solid polymer matrix film inside the mirror. These mirror assemblies were then placed in an electrically heated convection oven maintained at about 80° C. for about 2 hours.

E. Use of Electrochromic Mirror

We applied a potential of about 1.4 volts to one of the electrochromic mirrors, and observed this mirror to color rapidly and uniformly to a gray color with greenish hue.

In addition, we observed that the high reflectance at the center portion of the mirror was about 64.1% reflectance which decreased to a low reflectance of about 6.5% when about 1.4 volts was applied to thereto. The response time for reflectance to change from about 60% to about 20% when that potential was applied thereto was about 2.6 seconds. We made this determination by the reflectometer described in Example 1, supra.

We also observed that the mirror bleached from about 10% reflectance to about 50% reflectance in a response time of about 12.7 seconds under about a zero applied potential. We noted the bleaching to be uniform.

Example 33

A. Preparation of Electrochromic Monomer Composition

We prepared an electrochromic monomer composition comprising by weight about 0.3% HHVPF₆ (as a cathodic compound), about 0.97% EVClO₄ (as a cathodic compound), about 0.59% 5,10-dihydro-5,10-dimethylphenazine (as an anodic compound), all homogeneously dispersed in a combination of about 89.71% propylene carbonate (as plasticizer) and, in combination as a monomer component, about 0.65% HDT (an isocyanate) and about 3.08% Lexorez 1931-50 (a polyol), and about 0.03% T-9 (a tin catalyst), and about 4.67% Uvinul N 35 (a UV stabilizer). We thoroughly mixed this monomer composition to ensure that a homogeneous dispersion of the components was achieved.

B. Mirror assembly with Electrochromic Monomer Composition

In this example, we assembled interior automotive mirrors from TEC 15 and from HW-ITO glass substrates (where the conductive surface of each glass substrate faced one another), with both the clear, front glass and the silvered, rear glass having a sheet resistance of about 15 ohms per

square. The dimensions of the mirror assemblies were about $2.5'' \times 10'' \times 105 \mu\text{m}$, with a weather barrier of an epoxy resin coupled with spacers of about $105 \mu\text{m}$ also applied.

We placed into these mirror assemblies the electrochromic monomer composition of Example 33(A), supra, using the vacuum back filling technique (as described in Varaprasad III, supra).

C. Transformation of Electrochromic Monomer Composition within Mirror to Polychromic Solid Film

Once the electrochromic monomer composition of Example 33(A), supra, was uniformly applied within the mirror assemblies of Example 33(B), supra, we placed the assemblies in an electrically heated convection oven maintained at about 80°C . for about 2 hours whereupon the monomer composition reacted to form in situ the solid polymer matrix film inside the mirror.

D. Use of Electrochromic Mirror

We applied a potential of about 1.4 volts to one of the electrochromic mirrors, and observed this mirror to color rapidly and uniformly to a gray color with greenish hue.

In addition, we observed that the high reflectance at the center portion of the mirror was about 71.8% reflectance which decreased to a low reflectance of about 7.0% when about 1.4 volts was applied to thereto. The response time for reflectance to change from about 70% to about 20% when that potential was applied thereto was about 2.2 seconds. We made this determination by the reflectometer described in Example 1, supra.

We also observed that the mirror bleached from about 10% reflectance to about 60% reflectance in a response time of about 4.9 seconds under about a zero applied potential. We noted the bleaching to be uniform.

E. Stability and Cyclability of Electrochromic Devices Manufactured with Polychromic Solid Films

To demonstrate the cycle stability of the electrochromic mirrors assemblies of Example 33(B and C), supra, we subjected the electrochromic mirrors made from TEC 15 glass substrates to 20 seconds color—20 seconds bleach cycles at different test temperatures required by automotive specifications. We have observed good cycle stability after about 85,000 cycles which include about 25,000 cycles at 70°C ., about 20,000 cycles at -30°C ., and about 40,000 cycles at room temperature. We observed, that the high reflectance of the mirror at the center portion of the mirror changed from 71.8% to 71.0% and that the low reflectance changed from 7.0% to 7.5% after about 85,000 cycles. We also observed that the response time for reflectance change from about 70% to about 20% changed from 2.2 seconds to 2.7 seconds and the response time for reflectance change from about 10% to about 60% changed from 4.9 seconds to 5.2 seconds after about 85,000 cycles.

To demonstrate the ultraviolet stability, we exposed the electrochromic mirror assemblies made from HW-ITO glass substrate of Example 33 supra, to at least about 2600 kJ/m^2 using a Xenon weatherometer as per SAE J1960. We observed, that the high reflectance of the mirror at the center portion of the mirror changed from 79.4% to 78.9% and that the low reflectance changed from 6.0% to 6.25% after exposure to ultraviolet radiation. We also observed that the response time for reflectance change from about 70% to

about 20% changed from 1.6 seconds to 1.7 seconds and the response time for reflectance change from about 10% to about 60% changed from 4.1 seconds to 4.4 seconds after exposure to ultraviolet radiation.

To demonstrate the thermal stability of the electrochromic mirror assemblies of Example 33(B and C), supra, we placed the mirror assemblies made from HW-ITO glass substrates in an electric oven maintained at about 85°C . for at least about 400 hours. We observed, that the high reflectance of the mirror at the center portion of the mirror changed from 79% to 77% and that the low reflectance changed from 6.1% to 5.7% after the heat test. We also observed that the response time for reflectance change from about 70% to about 20% changed from 1.5 seconds to 1.7 seconds and the response time for reflectance change from about 10% to about 60% changed from 4.1 seconds to 4.4 seconds after the heat test.

The environmental and overall performance the electrochromic mirrors was suitable for use in a vehicle.

Example 34

A. Preparation of Electrochromic Monomer Composition

We prepared an electrochromic monomer composition comprising by weight about 0.37% HUVPE (as a cathodic compound), about 0.96% EVCIO_2 (as a cathodic compound), about 0.59% 5,10-dihydro-5,10-dimethylphenazine (as an anodic compound), all homogeneously dispersed in a combination of about 89.65% propylene carbonate (as plasticizer) and, in combination as a monomer component, about 0.65% HDT (an isocyanate) and about 3.08% Lexorez 1931-50 (a polyol), and about 0.03% T-1 (a tin catalyst), and about 4.67% Uvinal N 35 (a UV stabilizer). We thoroughly mixed this monomer composition to ensure that a homogeneous dispersion of the components was achieved.

B. Mirror assembly with Electrochromic Monomer Composition

In this example, we assembled exterior automotive mirrors using TEC 15 glass for the front substrate and a multi-layer metal reflector coated glass (consisting of about 200 angstroms of rhodium undercoated with about 1500 angstroms of chromium, and with the chromium being disposed between the rhodium layer and the glass surface so as to serve as an adhesion promoter layer such as is described in U.S. application Ser. No. 08/238,521 filed May 5, 1994, the disclosure of which is hereby incorporated by reference herein) for the rear substrate (where the conductive surface of each glass substrate faced one another), with the clear front glass having a sheet resistance of about 15 ohms per square and the rear multi-layered reflector coated glass having a sheet resistance of about 5 ohms per square. The dimensions of the mirror assemblies were about $3.5'' \times 7.5'' \times 105 \mu\text{m}$, with a weather barrier of an epoxy resin coupled with spacers of about $105 \mu\text{m}$ also applied.

We placed into these mirror assemblies the electrochromic monomer composition of Example 34(A), supra, using the vacuum back filling technique (as described in Varaprasad III supra).

C. Transformation of Electrochromic Monomer Composition within Mirror to Polychromic Solid Film

Once the electrochromic monomer composition of Example 34(A), supra, was uniformly applied within the

mirror assemblies of Example 34(B), supra, we placed the assemblies in an electrically heated convection oven maintained at about 80° C. for about 2 hours whereupon the monomer composition reacted to form in situ the solid polymer matrix film inside the mirror.

D. Use of Electrochromic Mirror

We applied a potential of about 1.4 volts to one of the electrochromic mirrors, and observed this mirror to color rapidly and uniformly to a gray color with greenish hue.

In addition, we observed that the high reflectance at the center portion of the mirror was about 56.3% reflectance which decreased to a low reflectance of about 7.0% when about 1.4 volts was applied to thereto. The response time for reflectance to change from about 55% to about 20% when that potential was applied thereto was 1.2 seconds. We made this determination by the reflectometer described in Example 1, supra.

We also observed that the mirror bleached from about 10% reflectance to about 50% reflectance in a response time of about 5.8 seconds under about a zero applied potential. We noted the bleaching to be uniform.

Example 35

A. Preparation of Electrochromic Monomer Composition

We prepared an electrochromic monomer composition comprising by weight about 1.09% HUVPF₆ (as a cathodic compound), about 0.58% EVClO₄ (as a cathodic compound), about 0.59% 5,10-dihydro-5,10-dimethylphenazine (as an anodic compound), all homogeneously dispersed in a combination of about 89.34% propylene carbonate (as plasticizer) and, in combination as a monomer component, about 0.84% HDT (an isocyanate) and about 2.88% Lexorez 1931-50 (a polyol), and about 0.03% T-1 (a tin catalyst), and about 4.65% Uvinul N 35 (a UV stabilizer). We thoroughly mixed this monomer composition to ensure that a homogeneous dispersion of the components was achieved.

B. Mirror assembly with Electrochromic Monomer Composition

In this example, we assembled interior automotive mirrors from TEC-15 glass substrates (where the conductive surface of each glass substrate faced one another), with both the clear, front glass and the silvered, rear glass having a sheet resistance of about 15 ohms per square. The dimensions of the mirror assemblies were about 2.5"×10"×105 μm, with a weather barrier of an epoxy resin coupled with spacers of about 105 μm also applied.

We placed into these mirror assemblies the electrochromic monomer composition of Example 35(A), supra, using the vacuum back filling technique (as described in Varaprasad III, supra).

C. Transformation of Electrochromic Monomer Composition within Mirror to Polychromic Solid Film

Once the electrochromic monomer composition of Example 35(A), supra, was uniformly applied within the mirror assemblies of Example 35(B), supra, we placed the assemblies overnight at room temperature during which time the monomer composition reacted to form in situ the solid polymer matrix film inside the mirror. These mirror assem-

blies were then placed in an electrically heated convection oven maintained at about 80° C. for about 2 hours.

D. Use of Electrochromic Mirror

We applied a potential of about 1.4 volts to one of the electrochromic mirrors, and observed this mirror to color rapidly and uniformly to a gray color with greenish hue.

In addition, we observed that the high reflectance at the center portion of the mirror was about 72.1% reflectance which decreased to a low reflectance of about 7.3% when about 1.4 volts was applied to thereto. The response time for reflectance to change from about 70% to about 20% when that potential was applied thereto was about 2.0 seconds. We made this determination by the reflectometer described in Example 1, supra.

We also observed that the mirror bleached from about 10% reflectance to about 60% reflectance in a response time of about 7.9 seconds under about a zero applied potential. We noted the bleaching to be uniform.

Example 36

A. Preparation of Electrochromic Monomer Composition

We prepared an electrochromic monomer composition comprising by weight about 0.3% HHVPF₆ (as a cathodic compound), about 0.96% EVClO₄ (as a cathodic compound), about 0.59% 5,10-dihydro-5,10-dimethylphenazine (as an anodic compound), all homogeneously dispersed in a combination of about 84.13% propylene carbonate (as plasticizer) and, in combination as a monomer component, about 1.38% HDT (an isocyanate) and about 7.96% Lexorez 1931-50 (a polyol), and about 0.01% T-9 (a tin catalyst), and about 4.67% Uvinul N 35 (a UV stabilizer). We thoroughly mixed this monomer composition to ensure that a homogeneous dispersion of the components was achieved.

B. Mirror assembly with Electrochromic Monomer Composition

In this example, we assembled interior automotive mirrors from TEC-15 glass substrates (where the conductive surface of each glass substrate faced one another), with both the clear, front glass and the silvered, rear glass having a sheet resistance of about 15 ohms per square. The dimensions of the mirror assemblies were about 2.5"×10"×105 μm, with a weather barrier of an epoxy resin coupled with spacers of about 105 μm also applied.

We placed into these mirror assemblies the electrochromic monomer composition of Example 36(A), supra, using the vacuum back filling technique (as described in Varaprasad III, supra).

C. Transformation of Electrochromic Monomer Composition within Mirror to Polychromic Solid Film

Once the electrochromic monomer composition of Example 36(A), supra, was uniformly applied within the mirror assemblies of Example 36(B), supra, we placed the assemblies in an electrically heated convection oven maintained at about 80° C. for about 2 hours whereupon the monomer composition reacted to form in situ the solid polymer matrix film inside the mirror.

D. Use of Electrochromic Mirror

We applied a potential of about 1.4 volts to one of the electrochromic mirrors, and observed this mirror to color rapidly and uniformly to a gray color with greenish hue.

In addition, we observed that the high reflectance at the center portion of the mirror was about 69.9% reflectance which decreased to a low reflectance of about 8.0% when about 1.4 volts was applied to thereto. The response time for reflectance to change from about 70% to about 20% when that potential was applied thereto was about 2.1 seconds. We made this determination by the reflectometer described in Example 1, supra.

We also observed that the mirror bleached from about 10% reflectance to about 60% reflectance in a response time of about 5.2 seconds under about a zero applied potential. We noted the bleaching to be uniform.

Example 37

A. Preparation of Electrochromic Monomer Composition

We prepared an electrochromic monomer composition comprising by weight about 0.65% HUVClO₄ (as a cathodic compound), about 0.77% EVClO₄ (as a cathodic compound), about 0.59% 5,10-dihydro-5,10-dimethylphenazine (as an anodic compound), all homogeneously dispersed in a combination of about 89.57% propylene carbonate (as plasticizer) and, in combination as a monomer component, about 0.79% HDT (an isocyanate) and about 2.94% Lexorez 1931-50 (a polyol), and about 0.03% T-1 (a tin catalyst), and about 4.66% Uvinul N 35 (a UV stabilizer). We thoroughly mixed this monomer composition to ensure that a homogeneous dispersion of the components was achieved.

B. Mirror assembly with Electrochromic Monomer Composition

In this example, we assembled interior automotive mirrors from TEC-15 glass substrates (where the conductive surface of each glass substrate faced one another), with both the clear, front glass and the silvered, rear glass having a sheet resistance of about 15 ohms per square. The dimensions of the mirror assemblies were about 2.5"×10"×105 μm, with a weather barrier of an epoxy resin coupled with spacers of about 105 μm also applied.

We placed into these mirror assemblies the electrochromic monomer composition of Example 37(A), supra, using the vacuum back filling technique (as described in Varasprad III, supra).

C. Transformation of Electrochromic Monomer Composition within Mirror to Polychromic Solid Film

Once the electrochromic monomer composition of Example 37(A), supra, was uniformly applied within the mirror assemblies of Example 37(B), supra, we placed the assemblies overnight at room temperature during which time the monomer composition reacted to form in situ the solid polymer matrix film inside the mirror. These mirror assemblies were then placed in an electrically heated convection oven maintained at about 80° C. for about 2 hours.

D. Use of Electrochromic Mirror

We applied a potential of about 1.4 volts to one of the electrochromic mirrors, and observed this mirror to color rapidly and uniformly to a gray color with greenish hue.

In addition, we observed that the high reflectance at the center portion of the mirror was about 74.0% reflectance which decreased to a low reflectance of about 7.5% when

about 1.4 volts was applied to thereto. The response time for reflectance to change from about 70% to about 20% when that potential was applied thereto was about 2.0 seconds. We made this determination by the reflectometer described in Example 1, supra.

We also observed that the mirror bleached from about 10% reflectance to about 60% reflectance in a response time of about 6.2 seconds under about a zero applied potential. We noted the bleaching to be uniform.

Example 38

A. Preparation of Electrochromic Monomer Composition

We prepared an electrochromic monomer composition comprising by weight about 0.52% HUEVClO₄ (as a cathodic compound), about 0.77% EVClO₄ (as a cathodic compound), about 0.59% 5,10-dihydro-5,10-dimethylphenazine (as an anodic compound), all homogeneously dispersed in a combination of about 88.75% propylene carbonate (as plasticizer) and, in combination as a monomer component, about 0.93% HDT (an isocyanate) and about 3.74% Lexorez 1931-50 (a polyol), and about 0.03% T-1 (a tin catalyst), and about 4.67% Uvinul N 35 (a UV stabilizer). We thoroughly mixed this monomer composition to ensure that a homogeneous dispersion of the components was achieved.

B. Mirror assembly with Electrochromic Monomer Composition

In this example, we assembled interior automotive mirrors from TEC-15 glass substrates (where the conductive surface of each glass substrate faced one another), with both the clear, front glass and the silvered, rear glass having a sheet resistance of about 15 ohms per square. The dimensions of the mirror assemblies were about 2.5"×10"×105 μm, with a weather barrier of an epoxy resin coupled with spacers of about 105 μm also applied.

We placed into these mirror assemblies the electrochromic monomer composition of Example 38(A), supra, using the vacuum back filling technique (as described in Varasprad III, supra).

C. Transformation of Electrochromic Monomer Composition within Mirror to Polychromic Solid Film

Once the electrochromic monomer composition of Example 38(A), supra, was uniformly applied within the mirror assemblies of Example 38(B), supra, we placed the assemblies overnight at room temperature during which time the monomer composition reacted to form in situ the solid polymer matrix film inside the mirror. These mirror assemblies were then placed in an electrically heated convection oven maintained at about 80° C. for about 2 hours.

D. Use of Electrochromic Mirror

We applied a potential of about 1.4 volts to one of the electrochromic mirrors, and observed this mirror to color rapidly and uniformly to a gray color with greenish hue.

In addition, we observed that the high reflectance at the center portion of the mirror was about 72.9% reflectance which decreased to a low reflectance of about 7.1% when about 1.4 volts was applied to thereto. The response time for reflectance to change from about 70% to about 20% when that potential was applied thereto was about 2.0 seconds. We

made this determination by the reflectometer described in Example 1, supra.

We also observed that the mirror bleached from about 10% reflectance to about 60% reflectance in a response time of about 5.4 seconds under about a zero applied potential. We noted the bleaching to be uniform.

Example 39

A. Preparation of Electrochromic Monomer Composition

We prepared an electrochromic monomer composition comprising by weight about 0.3% HHVPF₆ (as a cathodic compound), about 0.96% EVCIO₄ (as a cathodic compound), about 0.49% 5,10-dihydro-5,10-dimethylphenazine (as an anodic compound), and about 0.13% THAC having been previously reduced by contacting with zinc (U.S. Pat. No. 5,500,760 issued Mar. 19, 1996 the disclosure of which is incorporated by reference herein) (as an anodic compound), all homogeneously dispersed in a combination of about 85.34% propylene carbonate and about 0.91% acetic acid (as plasticizer) and, in combination as a monomer component, about 1.59% HDT (an isocyanate) and about 5.42% Lexorez 1931-50 (a polyol), and about 0.19% T-9 (a tin catalyst), and about 4.67% Uvinul N 35 (a UV stabilizer). We thoroughly mixed this monomer composition to ensure that a homogeneous dispersion of the components was achieved.

B. Mirror assembly with Electrochromic Monomer Composition

In this example, we assembled interior automotive mirrors from TEC-15 glass substrates (where the conductive surface of each glass substrate faced one another), with both the clear, front glass and the silvered, rear glass having a sheet resistance of about 15 ohms per square. The dimensions of the mirror assemblies were about 2.5"×10"×105 μm, with a weather barrier of an epoxy resin coupled with spacers of about 105 μm also applied.

We placed into these mirror assemblies the electrochromic monomer composition of Example 39(A), supra, using the vacuum back filling technique (as described in Varaprasad III, supra).

C. Transformation of Electrochromic Monomer Composition within Mirror to Polychromic Solid Film

Once the electrochromic monomer composition of Example 39(A), supra, was uniformly applied within the mirror assemblies of Example 39(B), supra, we placed the assemblies in an electrically heated convection oven maintained at about 80° C. for about 2 hours whereupon the monomer composition reacted to form in situ the solid polymer matrix film inside the mirror.

D. Use of Electrochromic Mirror

We applied a potential of about 1.4 volts to one of the electrochromic mirrors, and observed this mirror to color rapidly and uniformly to a gray color with greenish hue.

In addition, we observed that the high reflectance at the center portion of the mirror was about 67.4% reflectance which decreased to a low reflectance of about 6.6% when about 1.4 volts was applied to thereto. The response time for reflectance to change from about 65% to about 20% when that potential was applied thereto was about 2.5 seconds. We

made this determination by the reflectometer described in Example 1, supra.

We also observed that the mirror bleached from about 10% reflectance to about 60% reflectance in a response time of about 8.3 seconds under about a zero applied potential. We noted the bleaching to be uniform.

Example 40

A. Preparation of Electrochromic Monomer Composition

We prepared an electrochromic monomer composition comprising by weight about 0.3% HHVPF₆ (as a cathodic compound), about 0.97% EVCIO₄ (as a cathodic compound), about 0.59% 5,10-dihydro-5,10-dimethylphenazine (as an anodic compound), all homogeneously dispersed in a combination of about 89.71% propylene carbonate (as plasticizer) and, in combination as a monomer component, about 0.65% HDT (an isocyanate) and about 3.08% Lexorez 1931-50 (a polyol), and about 0.03% T-9 (a tin catalyst), and about 4.67% Uvinul N 35 (a UV stabilizer). We thoroughly mixed this monomer composition to ensure that a homogeneous dispersion of the components was achieved.

B. Mirror assembly with Electrochromic Monomer Composition

In this example, we assembled exterior automotive mirrors using clear HW-ITO glass for the front substrate and chromium metal coated glass for the rear substrate (where the conductive surface of each glass substrate faced one another), with the clear front glass having a sheet resistance of about 15 ohms per square and the rear chrome glass having a sheet resistance of 5 ohms per square. The dimensions of the mirror assemblies were about 3.5"×7.5"×105 μm, with a weather barrier of an epoxy resin coupled with spacers of about 105 μm also applied.

We placed into these exterior mirror assemblies the electrochromic monomer composition of Example 40(A), supra, using the vacuum back filling technique (as described in Varaprasad III, supra).

C. Transformation of Electrochromic Monomer Composition within Mirror to Polychromic Solid Film

Once the electrochromic monomer composition of Example 40(A), supra, was uniformly applied within the mirror assemblies of Example 40(B), supra, we placed the assemblies in an electrically heated convection oven maintained at about 80° C. for about 2 hours whereupon the monomer composition reacted to form in situ the solid polymer matrix film inside the mirror.

D. Use of Exterior Electrochromic Mirror

We applied a potential of about 1.4 volts to one of the electrochromic mirrors, and observed this mirror to color rapidly and uniformly to a gray color with greenish hue.

In addition, we observed that the high reflectance at the center portion of the mirror was about 52.7% reflectance which decreased to a low reflectance of about 6.4% when about 1.4 volts was applied to thereto. The response time for reflectance to change from high reflectance to about 23% when that potential was applied thereto was about 1.6 seconds. We made this determination by the reflectometer described in Example 1, supra.

We also observed that the mirror bleached from low reflectance to about 40% reflectance in a response time of about 6.9 seconds under about a zero applied potential. We noted the bleaching to be uniform.

E. Stability and Cyclability of Electrochromic Devices Manufactured with Polychromic Solid Films

To demonstrate the electrical stability of the mirror assemblies of Example 40(B and C), supra, we applied 1.4 volts and continuously colored the electrochromic mirrors for at least about 300 hours at room temperature. We observed that the high reflectance changed from 52.7% to 52.2% and the low reflectance remained unchanged at 6.4% after the continuous coloration test. We observed that the response time for reflectance to change from high reflectance to about 23% changed from 1.6 seconds to 2.0 seconds after the continuous coloration test and also that the response time for the mirror to bleach from low reflectance to about 40% reflectance remained steady at about 6.9 seconds before and after the continuous coloration test.

To demonstrate the cyclability of the mirror assemblies of Example 40(B and C), supra, we applied 1.4 volts and continuously colored the electrochromic mirrors for at least about 300 hours at room temperature.

To demonstrate the cycle stability of the electrochromic mirrors assemblies of Example 40(B and C), supra, we subjected the electrochromic mirrors to 20 seconds color—20 seconds bleach cycles at different test temperatures required by automotive specifications. We observed good cycle stability after about 80,000 cycles which include about 30,000 cycles at 70° C., and about 50,000 cycles at room temperature. We observed, that the high reflectance of the mirror at the center portion of the mirror changed from 53.22 to 51.1% and that the low reflectance changed from 6.5% to 7.1% after the cycle test. We also observed that the response time for reflectance change from high reflectance to about 23% remained constant at about 1.9 seconds after the cycle test and the response time for reflectance change from low reflectance to about 40% changed from 5.7 seconds to 5.5 seconds after the cycle test.

Example 41

In this example, we chose to illustrate the beneficial properties and characteristics of the polychromic solid films manufactured within electrochromic glazings, or that may be used as small area transmissive devices, such as optical filters and the like.

A. Preparation of Electrochromic Monomer Composition

We prepared an electrochromic monomer composition comprising by weight about 0.37% HUVPF₆ (as a cathodic compound), about 0.96% EVCIO₄ (as a cathodic compound), about 0.59% 5,10-dihydro-5,10-dimethylphenazine (as an anodic compound), all homogeneously dispersed in a combination of about 89.65% propylene carbonate (as plasticizer) and, in combination as a monomer component, about 0.65% HDT (an isocyanate) and about 3.08% Lexorez 1931-50 (a polyol), and about 0.03% T-1 (a tin catalyst), and about 4.67% Uvinul N 35 (a UV stabilizer). We thoroughly mixed this monomer composition to ensure that a homogeneous dispersion of the components was achieved.

B. Glazing Assembly with Electrochromic Monomer Composition

In this example, we assembled electrochromic glazings from clear TEC 15 glass substrates (where the conductive

surface of each glass substrate faced one another), with the glass having a sheet resistance of about 15 ohms per square. The dimensions of the glazing assemblies were about 2.5" × 10" × 105 μm, with a weather barrier of an epoxy resin coupled with spacers of about 105 μm also applied.

We placed into these glazing assemblies the electrochromic monomer composition of Example 41(A), supra, using the vacuum back filling technique (as described in Varaprasad III, supra).

C. Transformation of Electrochromic Monomer Composition within Glazing to Polychromic Solid Film

Once the electrochromic monomer composition of Example 41(A), supra, was uniformly applied within the glazing assemblies of Example 41(B), supra, we placed the assemblies in an electrically heated convection oven maintained at about 80° C. for about 2 hours whereupon the monomer composition reacted to form in situ the solid polymer matrix film inside the glazing assemblies.

D. Use of Electrochromic Glazing

We applied a potential of about 1.4 volts to one of the electrochromic glazings of Example 41(B and C), supra. We observed that the electrochromic glazings colored rapidly and uniformly to a gray color with greenish hue.

In addition, we observed that the high transmission at the center portion of the glazing was about 77.1% transmission which decreased to a low transmission of about 10.3% when about 1.4 volts was applied to thereto. The response time for transmission to change from about 70% to about 20% when that potential was applied thereto was 4 seconds. We made this determination by the reflectometer described in Example 1, supra.

We also observed that the glazing bleached from about 10% transmission to about 70% transmission in a response time of about 7.7 seconds under about a zero applied potential. We noted the bleaching to be uniform.

Example 42

A. Preparation of Electrochromic Monomer Composition

We prepared an electrochromic monomer composition comprising by weight about 0.3% DVAVPF₆ (as a cathodic compound), about 1.15% EVCIO₄ (as a cathodic compound), about 0.69% 5,10-dihydro-5,10-dimethylphenazine (as an anodic compound), all homogeneously dispersed in a combination of about 86.63% propylene carbonate (as plasticizer) and, in combination as a monomer component, about 0.93% HDT (an isocyanate) and about 5.59% Lexorez 1931-50 (a polyol), and about 0.05% dibutyltin dilaurate (a tin catalyst), and about 4.66% Uvinul N 35 (a UV stabilizer). We thoroughly mixed this monomer composition to ensure that a homogeneous dispersion of the components was achieved.

B. Mirror assembly with Electrochromic Monomer Composition

In this example, we assembled interior automotive mirrors from TEC-15 glass substrates (where the conductive surface of each glass substrate faced one another), with both the clear, front glass and the silvered, rear glass having a sheet resistance of about 15 ohms per square. The dimensions of the mirror assemblies were about 2.5" × 10" × 105 μm.

with a weather barrier of an epoxy resin coupled with spacers of about 105 μm also applied.

We placed into these mirror assemblies the electrochromic monomer composition of Example 42(A), supra, using the vacuum back filling technique (as described in Varaprasad III, supra).

C. Transformation of Electrochromic Monomer Composition within Mirror to Polychromic Solid Film

Once the electrochromic monomer composition of Example 42(A), supra, was uniformly applied within the mirror assemblies of Example 42(B), supra, we placed the assemblies in an electrically heated convection oven maintained at about 60° C. for about 1 hour whereupon the monomer composition reacted to form in situ the solid polymer matrix film inside the mirror.

D. Use of Electrochromic Mirror

We applied a potential of about 1.4 volts to one of the electrochromic mirrors, and observed this mirror to color rapidly and uniformly to a gray color with greenish hue.

In addition, we observed that the high reflectance at the center portion of the mirror was about 68.0% reflectance which decreased to a low reflectance of about 6.7% when about 1.2 volts was applied to thereto. The response time for reflectance to change from about 60% to about 20 when that potential was applied thereto was about 2.4 seconds. We made this determination by the reflectometer described in Example 1, supra.

We also observed that the mirror bleached from about 10% reflectance to about 60% reflectance in a response time of about 5.7 seconds under about a zero applied potential. We noted the bleaching to be uniform.

Example 43

A. Preparation of Electrochromic Monomer Composition

We prepared an electrochromic monomer composition comprising by weight about 2.18% HUVPF₆ (as a cathodic compound), about 0.58% 5,10-dihydro-5,10dimethylphenazine (as an anodic compound), all homogeneously dispersed in a combination of about 88.87% propylene carbonate (as plasticizer) and, in combination as a monomer component, about 1.3% HDT (an isocyanate) and about 2.41% Lexorez 1931-50 (a polyol), and about 0.03% T-1 (a tin catalyst), and about 4.63% Uvinul N 35 (a UV stabilizer). We thoroughly mixed this monomer composition to ensure that a homogeneous dispersion of the components was achieved.

B. Mirror assembly with Electrochromic Monomer Composition

In this example, we assembled interior automotive mirrors from TEC-15 glass substrates (where the conductive surface of each glass substrate faced one another), with both the clear, front glass and the silvered, rear glass having a sheet resistance of about 15 ohms per square. The dimensions of the mirror assemblies were about 2.5"×10"×105 μm , with a weather barrier of an epoxy resin coupled with spacers of about 105 μm also applied.

We placed into these mirror assemblies the electrochromic monomer composition of Example 43(A), supra, using the vacuum back filling technique (as described in Varaprasad III, supra).

C. Transformation of Electrochromic Monomer Composition within Mirror to Polychromic Solid Film

Once the electrochromic monomer composition of Example 43(A), supra, was uniformly applied within the mirror assemblies of Example 43(B), supra, we placed the assemblies in an electrically heated convection oven maintained at about 80° C. for about 1 hour whereupon the monomer composition reacted to form in situ the solid polymer matrix film inside the mirror.

D. Use of Electrochromic Mirror

We applied a potential of about 1.4 volts to one of the electrochromic mirrors, and observed this mirror to color rapidly and uniformly to a gray color with greenish hue.

In addition, we observed that the high reflectance at the center portion of the mirror was about 71.2% reflectance which decreased to a low reflectance of about 12.5% when about 1.2 volts was applied to thereto. The response time for reflectance to change from about 70% to about 20% when that potential was applied thereto was about 5.3 seconds. We made this determination by the reflectometer described in Example 1, supra.

We also observed that the mirror bleached from about 15% reflectance to about 50% reflectance in a response time of about 12.0 seconds under about a zero applied potential. We noted the bleaching to be uniform.

Example 44

A. Preparation of Electrochromic Monomer Composition

We prepared an electrochromic monomer composition comprising by weight about 0.66% HVSS (as a cathodic compound), about 1.52% EVCIO₄ (as a cathodic compound), about 0.17% ferrocene (as an anodic compound), about 0.74% phenothiazine (as an anodic compound) all homogeneously dispersed in a combination of about 87.6% propylene carbonate (as plasticizer) and, in combination as a monomer component, about 4.61% dipentaerythritol pentaacrylate. We also added about 0.09% 1,1'-azobiscyclohexanecarbonitrile (as an initiator), about 4.61% Uvinul N 35 (a UV stabilizer). We thoroughly mixed this monomer composition to ensure that a homogeneous dispersion of the components was achieved.

B. Mirror assembly with Electrochromic Monomer Composition

In this example, we assembled interior automotive mirrors from HW-ITO glass substrates (where the conductive surface of each glass substrate faced one another), with both the clear, front glass and the silvered, rear glass having a sheet resistance of about 15 ohms per square. The dimensions of the mirror assemblies were about 2.5"×10"×125 μm , with a weather barrier of an epoxy resin coupled with spacers of about 125 μm also applied.

We placed into these mirror assemblies the electrochromic monomer composition of Example 44(A), supra, using the vacuum back filling technique (as described in Varaprasad III, supra).

C. Transformation of Electrochromic Monomer Composition within Mirror to Polychromic Solid Film

Once the electrochromic monomer composition of Example 44(A), supra, was uniformly applied within the

mirror assemblies of Example 44(B), supra, we placed the assemblies in an electrically heated convection oven maintained at about 80° C. for about 2 hour whereupon the monomer composition reacted to form in situ the solid polymer matrix film inside the mirror.

D. Use of Electrochromic Mirror

We applied a potential of about 1.3 volts to one of the electrochromic mirrors, and observed this mirror to color rapidly and uniformly to a gray color with bluish hue.

In addition, we observed that the high reflectance at the center portion of the mirror was about 65% reflectance which decreased to a low reflectance of about 6% when about 1.3 volts was applied to thereto. We made this determination by the reflectometer described in Example 1, supra. We noted that the response time to color and also the response time to bleach the mirror was suitable for use in a vehicle.

While we have provided the above examples of the foregoing invention for illustrative purposes employing preferred electrochromic compounds, monomer components and plasticizers, and other components it is to be understood that variations and equivalents of each of the prepared electrochromic monomer compositions identified herein will provide suitable, if not comparable, results when viewed in connection with the results gleaned from these examples. Without undue experimentation, those of ordinary skill in the art will find it readily apparent to prepare polychromic solid film with the beneficial properties and characteristics desirable for the specific application armed with the teaching herein disclosed. And, it is intended that such equivalents be encompassed by the claims which follow hereinafter.

What we claim is:

1. A variable transmission window assembly suitable for use as an architectural or vehicular glazing, said window assembly comprising:

a first glass substrate having a first transparent conductor coated surface;

a second glass substrate having a second transparent conductor coated surface, said second substrate positioned in substantially parallel spaced-apart relationship with said first substrate and with said first and second conductor coated surfaces facing each other; and

an electrochromic medium disposed between said first and second substrates whereby the transmission of light through said electrochromic medium is changed when an electrical potential is applied thereto and wherein said electrochromic medium comprises a plasticized, cross-linked polymeric solid film formed by curing an electrochromic monomer composition that includes at least one polyfunctional component capable of cross-linking, at least one anodic electrochromic compound, at least one cathodic electrochromic compound and a plasticizer.

2. The window assembly of claim 1, wherein said glazing exhibits reduced hydrostatic pressure when vertically mounted.

3. The window assembly of claim 2, wherein said glazing is a window for a home or an office.

4. The window assembly of claim 2, wherein said glazing is a windshield, side window, blacklight, visor or shadeband for a vehicle.

5. The window assembly of claim 1, wherein said polyfunctional component comprises a polyfunctional hydroxy compound.

6. The window assembly of claim 5, wherein said hydroxy compound comprises a glycol or a glycerol.

7. The window assembly of claim 5, wherein said hydroxy compound comprises a triol.

8. The window assembly of claim 1, wherein said polyfunctional component comprises a polyfunctional amino compound or a polyfunctional mercapto compound.

9. The window assembly of claim 8, wherein said amino compound comprises a primary amino compound or a secondary amino compound.

10. The window assembly of claim 1, wherein said polyfunctional component has a functionality of 2 or greater.

11. The window assembly of claim 1, wherein said plasticizer comprises a member selected from the group consisting of acetonitrile, benzylacetone, 3-hydroxypropionitrile, methoxypropionitrile, 3-ethoxypropionitrile, propylene carbonate, ethylene carbonate, glycerine carbonate, 2-acetylbutyrolactone, cyanoethyl sucrose, γ -butyrolactone, 2-methylglutaronitrile, N,N'-dimethylformamide, 3-methylsulfolane, methylethyl ketone, cyclopentanone, cyclohexanone, 4-hydroxy-4-methyl-2-pentanone, acetophenone, glutaronitrile, 3,3'-oxydipropionitrile, 2-methoxyethyl ether, triethylene glycol dimethyl ether and combinations thereof.

12. The window assembly of claim 1, wherein at least one of said first and second transparent conductor coated surfaces is coated with a transparent conductor comprising one of indium tin oxide, doped tin oxide and doped zinc oxide.

13. The window assembly of claim 12, wherein said transparent conductor may be selected from the group consisting of indium tin oxide, indium tin oxide full wave, indium tin oxide half wave, indium tin oxide half wave green, tin oxide, antimony-doped tin oxide, fluorine-doped tin oxide, antimony-doped zinc oxide and aluminum-doped zinc oxide.

14. The window assembly of claim 1, wherein said electrochromic medium comprises at least one of an ultraviolet stabilizer, a humectant, a coloring agent, a spacer, a flame retarding agent, a heat stabilizing agent, an antioxidant, a lubricating agent, a compatibilizing agent, an adhesion promoting agent and a coupling agent.

15. The window assembly of claim 1, wherein said anodic electrochromic compound comprises a member selected from the class of chemical compounds represented by the following formulae:

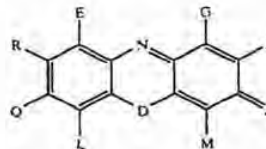

wherein

A is O, S or NRR₁;

wherein R and R₁ may be the same or different and each may be selected from the group consisting of H or any straight- or branched-chain alkyl constituent having from about one carbon atom to about eight carbon atoms, provided that when A is NRR₁, Q is H, OH or NRR₁;

D is O, S, NR, or Se;

E is R₁, COOH or CONH₂;

G is H;

105

J is H, any straight- or branched-chain alkyl constituent having from about one carbon atom to about eight carbon atoms, NRR_1 .



OR_1 , phenyl, 2,4-dihydroxyphenyl or any halogen; or G and J, taken together, represent an aromatic ring structure having six carbon ring atoms when viewed in conjunction with the ring carbon atoms to which they are attached;

L is H or OH;

M is H or any halogen;

T is R_1 , phenyl or 2,4-dihydroxyphenyl; and

Q is H, OH or NRR_1 ; provided that said anodic electrochromic compound I has been previously contacted with a redox agent;

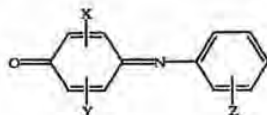

wherein X and Y may be the same or different and each may be selected from the group consisting of H, any halogen and NRR_1 , wherein R and R_1 may be the same or different and each may be selected from the group consisting of H or any straight- or branched-chain alkyl constituent having from about one carbon atom to about three carbon atoms; or, X and Y, taken together, represent an aromatic ring structure having six carbon ring atoms when viewed in conjunction with the ring carbon atoms to which they are attached; and

Z is OH or NRR_1 , or salts thereof; provided that said anodic electrochromic compound II has previously been contacted with a redox agent;

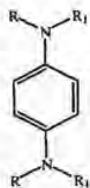
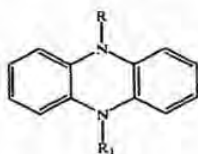

106

-continued

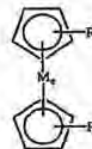
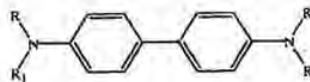

wherein R and R_1 may be the same or different, and each may be selected from the group consisting of H; any straight- or branched-chain alkyl constituent having from about 1 carbon atom to about 8 carbon atoms; acetyl; vinyl; allyl; $-(\text{CH}_2)_n-\text{OH}$, wherein n may be an integer in the range of 0 to about 20;

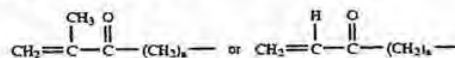

wherein n may be an integer in the range of 0 to about 20; $-(\text{CH}_2)_n-\text{COOR}_2$, wherein n may be an integer in the range of 0 to about 20 and R_2 may be any straight- or branched-chain alkyl constituent having from about 1 carbon atom to about 20 carbon atoms, hydrogen, lithium, sodium,

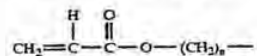
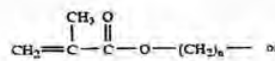

$-(\text{CH}_2)_n-\text{OR}_3$, wherein n' may be an integer in the range of 1 to about 12 and R_3 may be any straight- or branched-chain alkyl constituent having from about 1 carbon atom to about 8 carbon atoms.

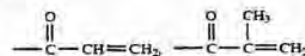

wherein n' may be an integer in the range of 1 to about 12;

wherein X may be selected from the group consisting of Cl^- , Br^- , I^- , PF_6^- , ClO_4^- and BF_4^- ;

wherein M_2 is selected from the group consisting of Fe, Ni, Ru, Co, Ti, Cr, W, and Mo;

107

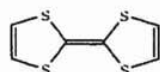

VII

and combinations thereof.

16. The window assembly of claim I, wherein said cathodic electrochromic compound comprises a member selected from the group of chemical compounds consisting of the following chemical formulae:

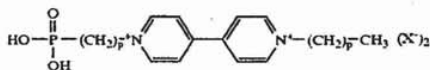
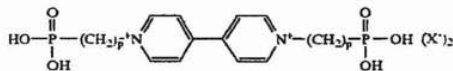
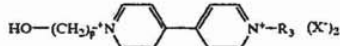
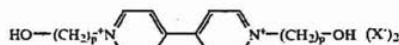
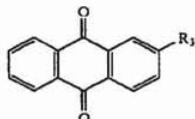
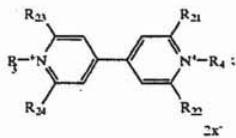

wherein R₃, R₄, R₂₁, R₂₂, R₂₃ and R₂₄ may be the same or different and each may be selected from the group consisting of H, any straight- or branched-chain alkyl constituent having from about one carbon atom to about eight carbon atoms, or any straight- or branched-chain alkyl- or alkoxy-phenyl, wherein the alkyl or alkoxy constituent contains from about one carbon atom to about eight carbon atoms;



wherein n' may be an integer in the range of 1 to 12;



wherein R₅ may be H or CH₃, and n' may be an integer in the range of 1 to 12; HO-(CH₂)_{n'}-, wherein n' may be an integer in the range of 1 to 12; and HOOC-(CH₂)_{n'}-, wherein n' may be an integer in the range of 1 to 12;

108

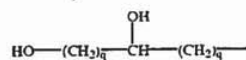
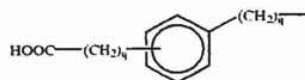
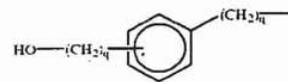

wherein q may be an integer in the range of 0 to 12; wherein each p is independently an integer from 1 to 12; wherein X is selected from the group consisting of BF₄⁻, ClO₄⁻, CF₃SO₃⁻, styrylsulfonate ("SS⁻"), 2-acrylamido-2-methylpropane-sulfonate, acrylate, methacrylate, 3-sulfopropylacrylate, 3-sulfopropylmethacrylate, PF₆⁻, Ac⁻, HO-(R₂₅)-SO₃⁻ and HOOC-(R₂₅)-SO₃⁻ wherein R₂₅ can be any straight- or branched-chain alkyl constituent having from about 1 carbon atom to about 8 carbon atoms, an aryl or a functionalized aryl, an alkyl or aryl amide, a branched or linear chain polymer, any halide; and combinations thereof.

17. The window assembly of claim I, wherein said cathodic electrochromic compound may be selected from the group consisting of ethylviologen perchlorate, heptylviologen styryl sulfonate, distyrylmethyl viologen perchlorate, ethylhydroxypropyl viologen perchlorate and combinations thereof.

18. The window assembly of claim 15, wherein said anodic electrochromic compound III is 5,10-dihydro-5,10-dimethylphenazine.

19. The window assembly of claim 15, wherein said anodic electrochromic compound VI is ferrocene.

20. The window assembly of claim I, wherein said curing of said electrochromic monomer composition is an in-situ cure after said monomer composition has been disposed between said first and second substrates.

21. The window assembly of claim I, wherein said glazing has a transmission in an unpowered state of at least 60% of light incident thereon.

22. The window assembly of claim I, wherein said glazing has a transmission less than 10% of light incident thereon when an electrical potential of 1.3 V is applied to said electrochromic medium.

23. The window assembly of claim I, wherein said glazing is a large area glazing of an area of at least 99 square inches.

24. The window assembly of claim I, wherein at least one of said first and second glass substrates comprises a specialized glass with reduced ultraviolet radiation transmission.

25. The window assembly of claim I, wherein at least one of said first and second glass substrates comprises tinted glass.

26. The window assembly of claim 25, wherein said tinted glass is one of a blue tinted glass and a gray tinted glass.

27. The window assembly of claim 14, wherein said electrochromic medium comprises an ultraviolet stabilizer in an amount, by weight, of about 0.1% to 15%.

* * * * *



US005724187A

United States Patent [19]
Varaprasad et al.

[11] **Patent Number:** 5,724,187
[45] **Date of Patent:** *Mar. 3, 1998

[54] **ELECTROCHROMIC MIRRORS AND DEVICES**

[58] **Field of Search** 359/601-610.
359/267-272; 252/583, 586

[75] **Inventors:** Desaraju V. Varaprasad; Ian A. McCabe; Hamid Habibi; Niall R. Lynam; Mingtang Zhao, all of Holland; Craig A. Dornan, Grand Haven, all of Mich.

[56] **References Cited**

U.S. PATENT DOCUMENTS

4,490,227 12/1984 Bitter 204/192.5 P
4,561,625 12/1985 Weaver 249/85
5,189,537 2/1993 O'Farrell 359/71

OTHER PUBLICATIONS

"Automobile Applications of Chromogenic Maleval"
Lynom et al Donnelly Corp.

Primary Examiner—Thong Nguyen
Attorney, Agent, or Firm—Fitzpatrick, Cella, Harper & Scinto

[73] **Assignee:** Donnelly Corporation, Holland, Mich.

[*] **Notice:** The term of this patent shall not extend beyond the expiration date of Pat. No. 5,668,663.

[21] **Appl. No.:** 429,643

[22] **Filed:** Apr. 27, 1995

Related U.S. Application Data

[63] **Continuation-in-part of Ser. No. 238,521, May 5, 1994, Pat. No. 5,668,663.**

[51] **Int. Cl.⁶** G02B 5/08; G02F 1/153

[52] **U.S. Cl.** 359/608; 359/265; 359/273; 359/603; 359/604

[57] **ABSTRACT**

The present invention relates to electrochromic mirrors and devices whose electrochromic element is composed of an electrochromic solid film and an electrolyte comprising redox reaction promoters and alkali ions and/or protons.

22 Claims, 12 Drawing Sheets

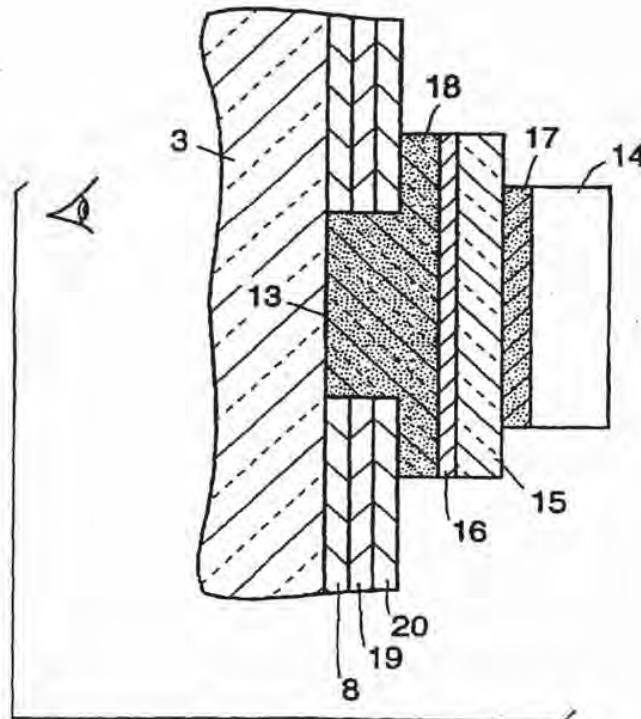

FIG. 1

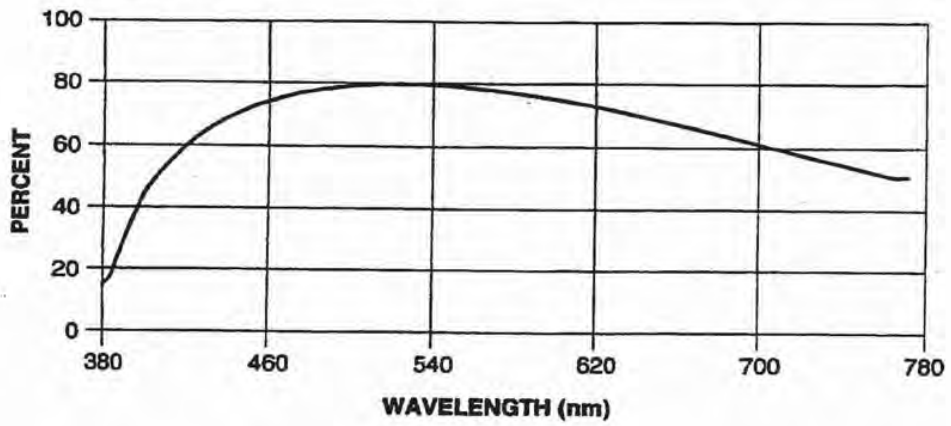
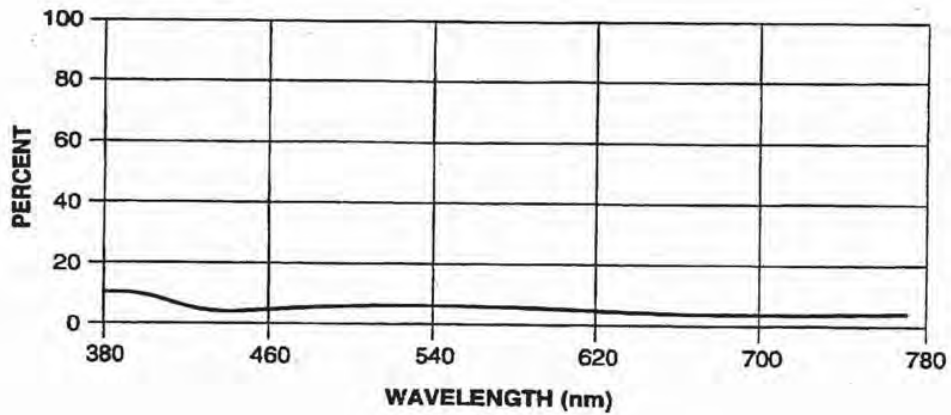
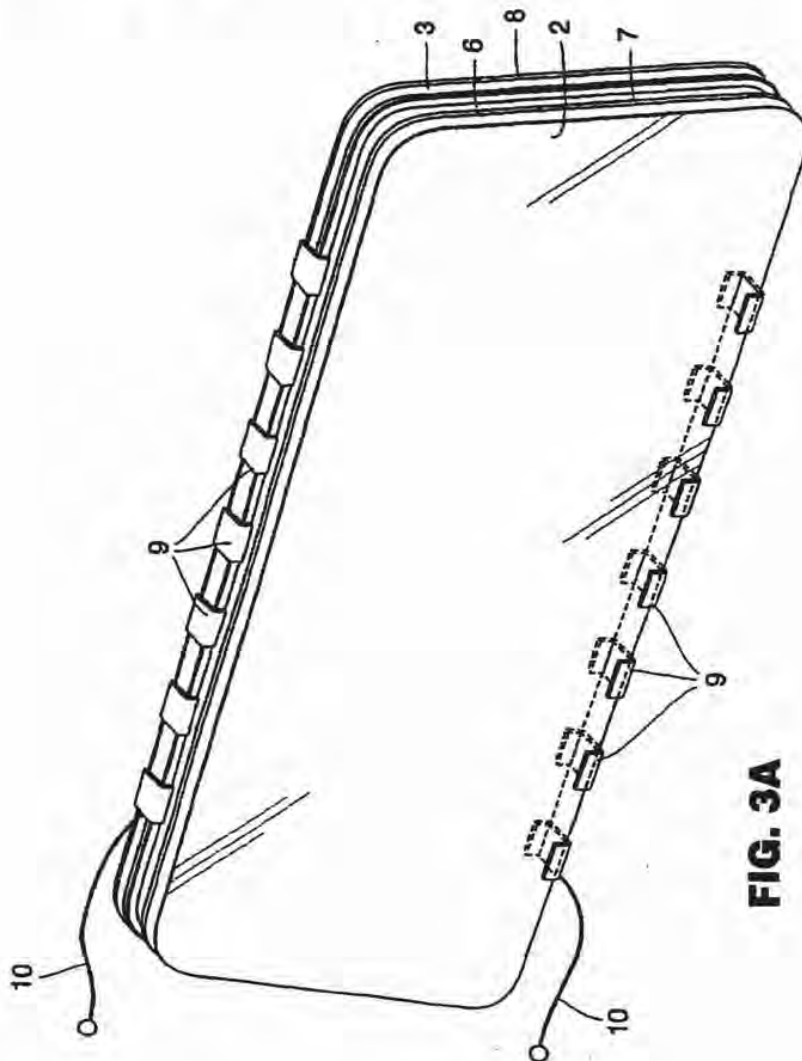
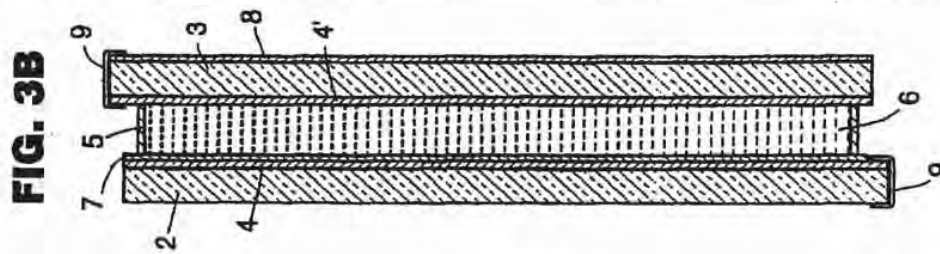

FIG. 2





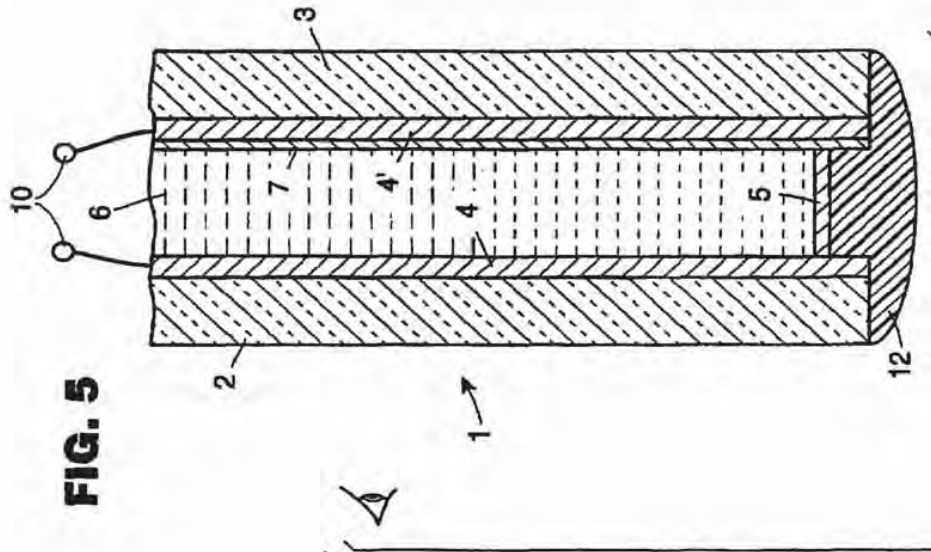

FIG. 5

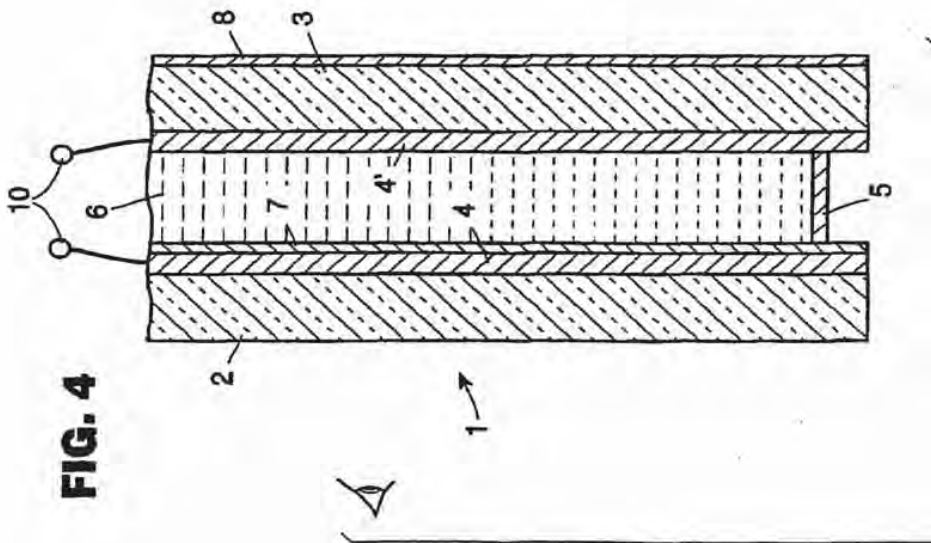

FIG. 4

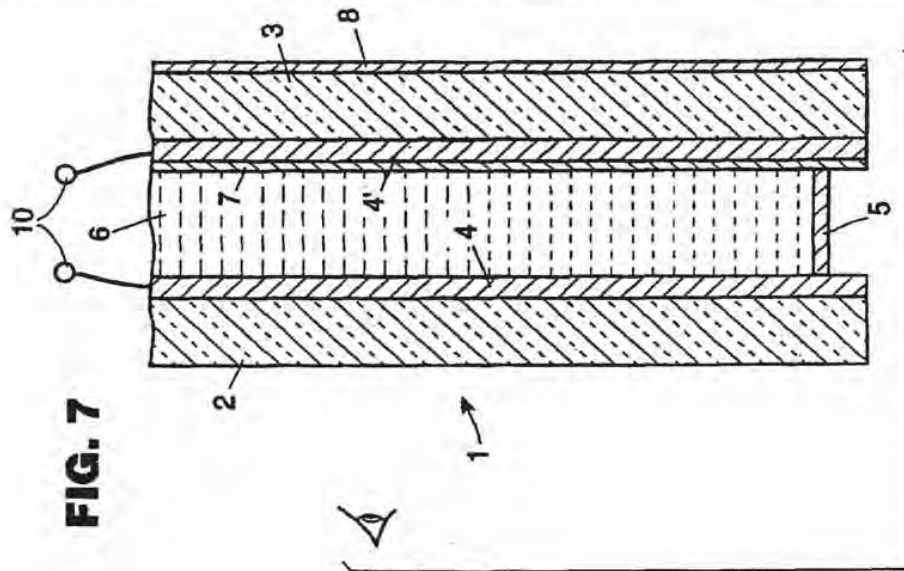

FIG. 7

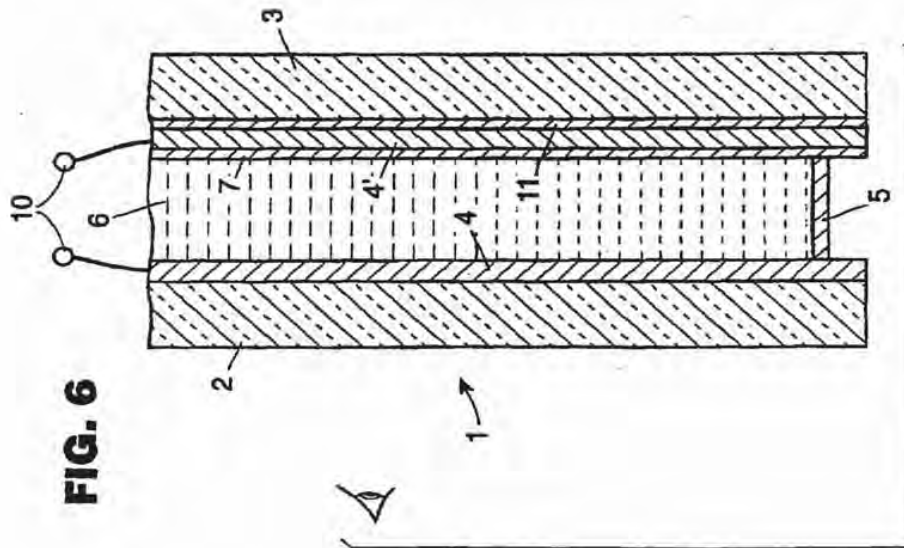

FIG. 6

FIG. 8

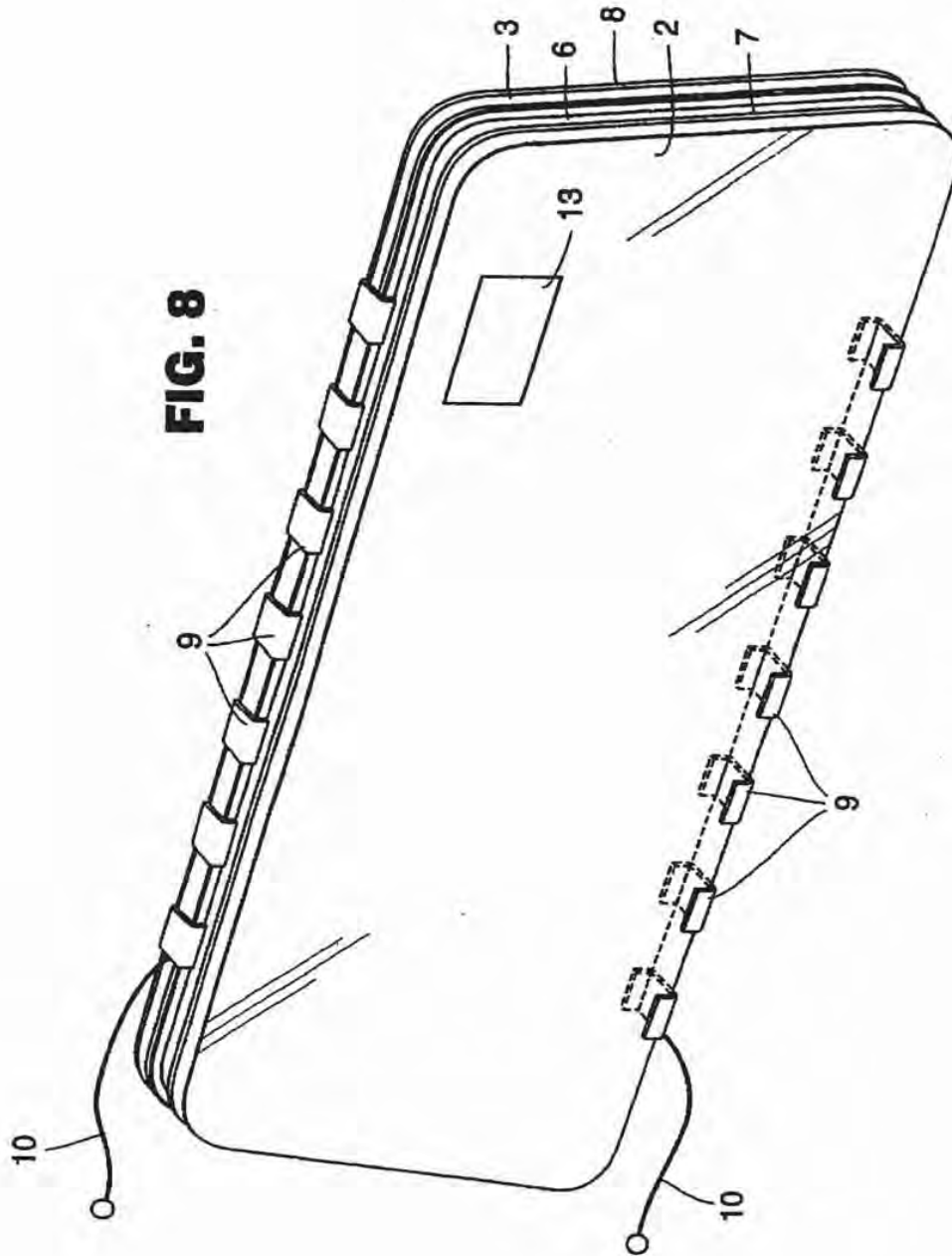

FIG. 10

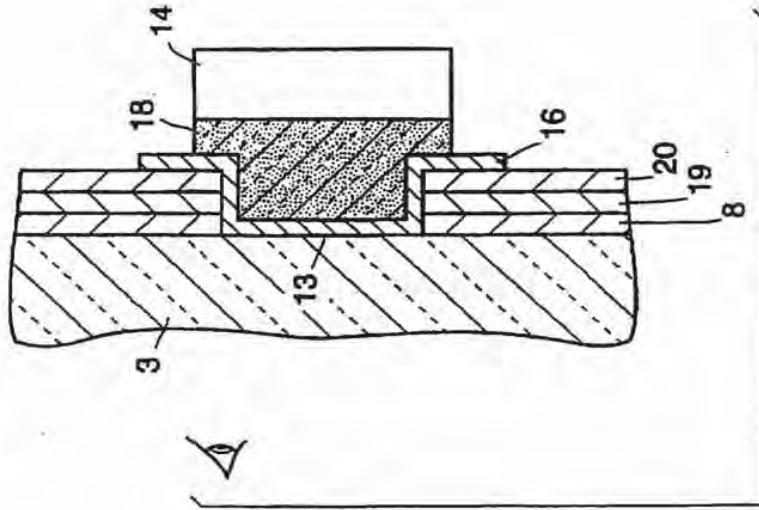

FIG. 9

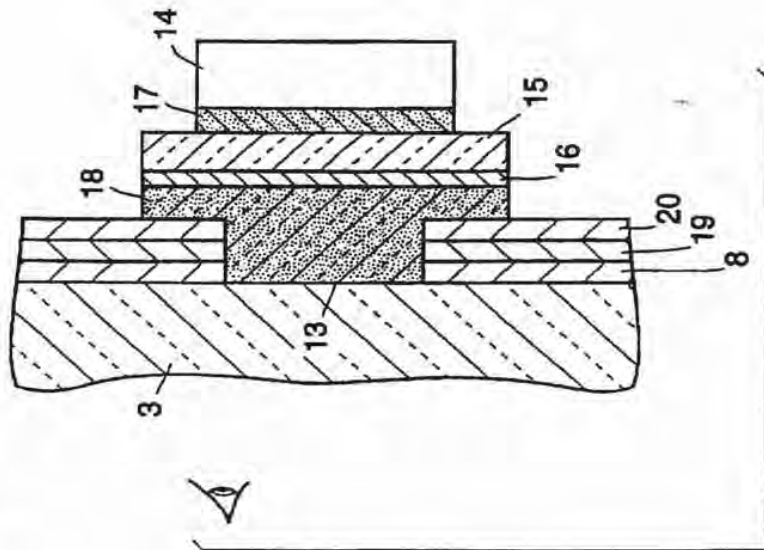

FIG. 11A

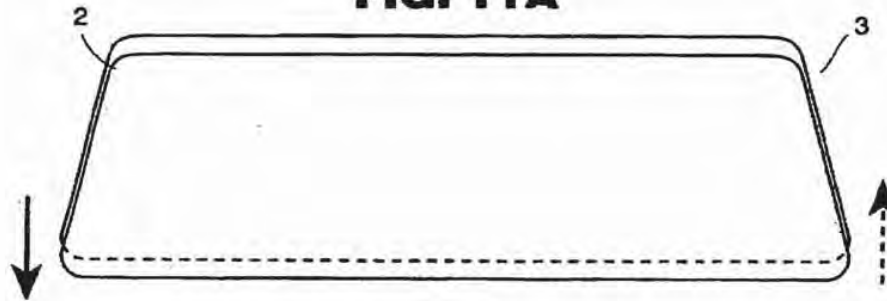

FIG. 11B

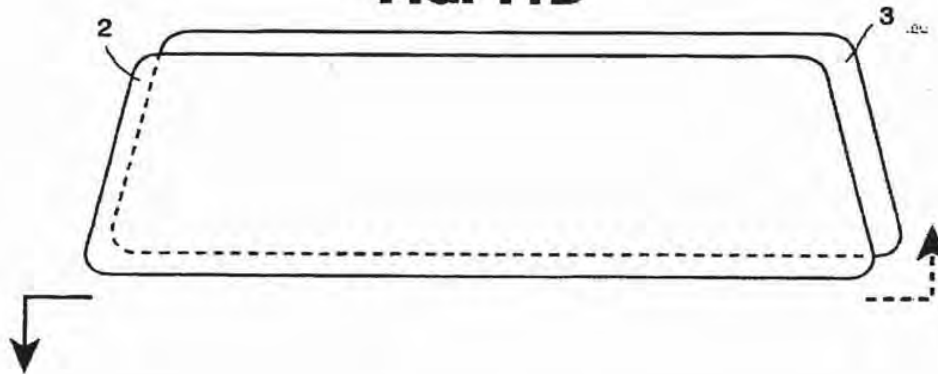
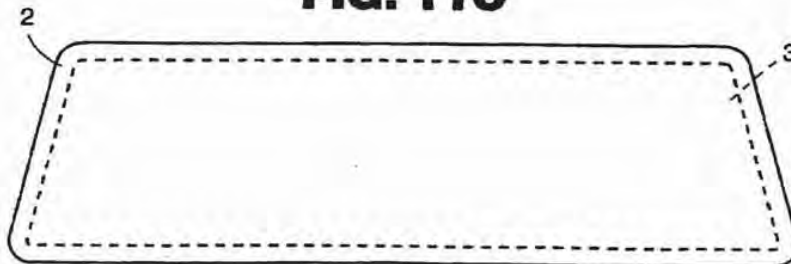

FIG. 11C



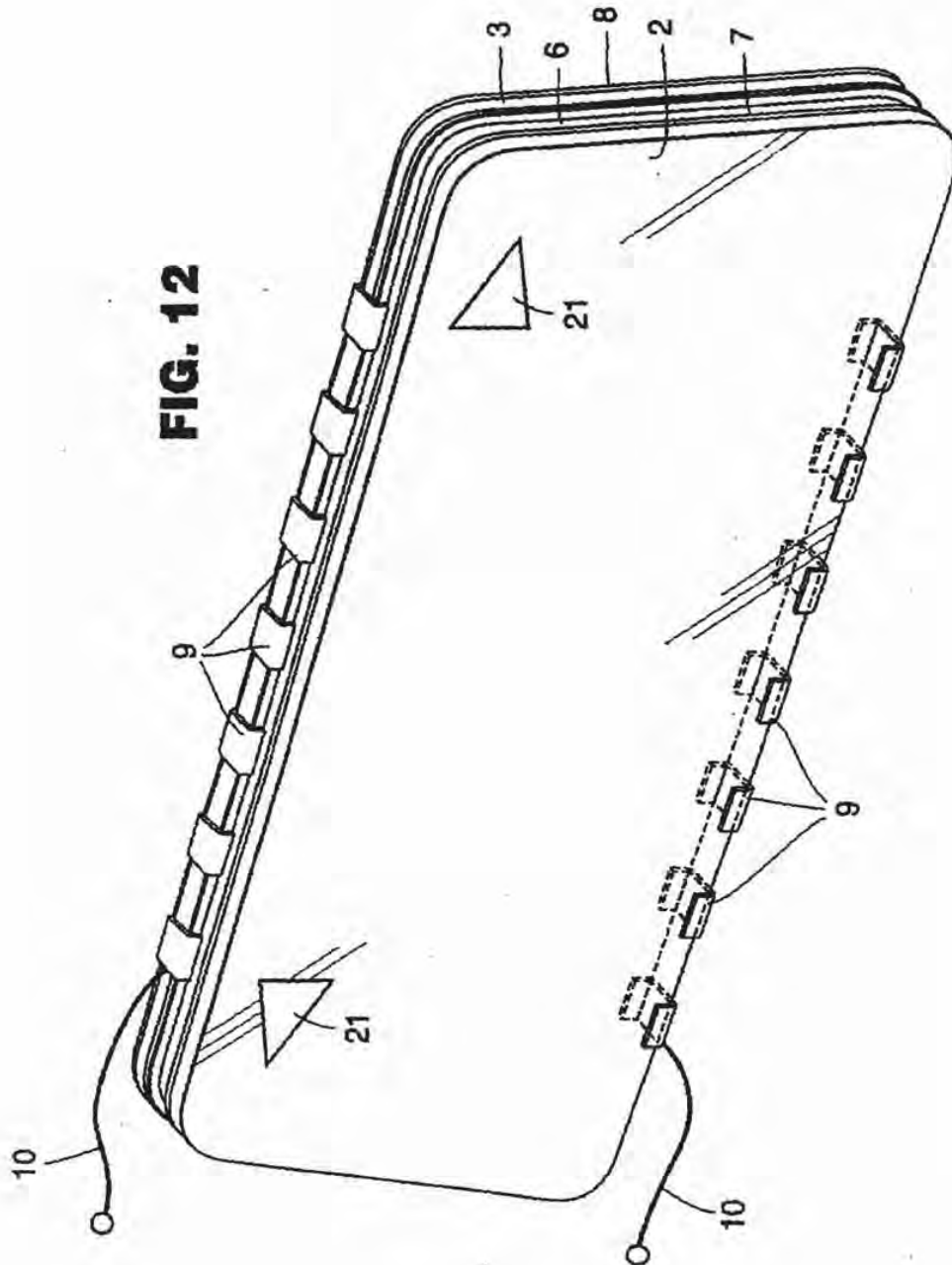

FIG. 13

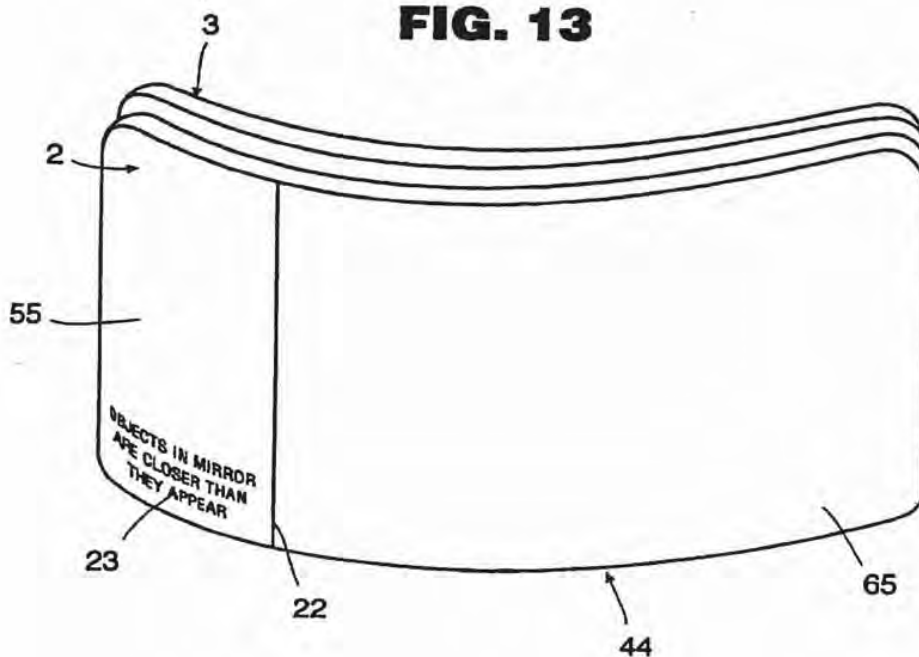

FIG. 14A

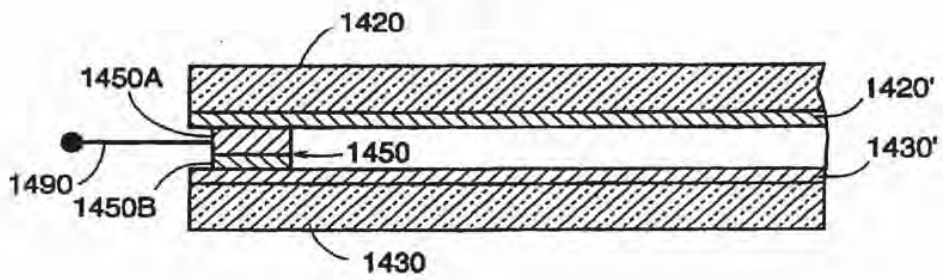

FIG. 14B

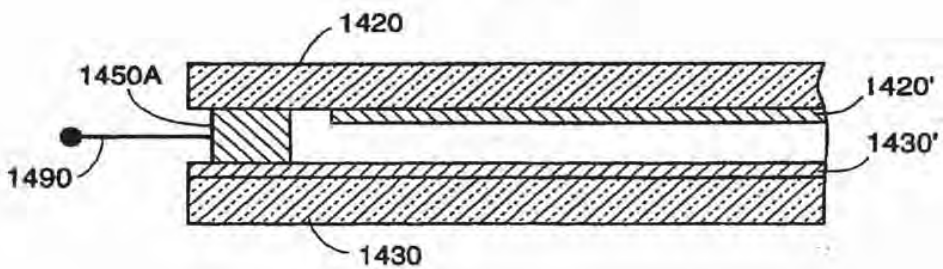

FIG. 15

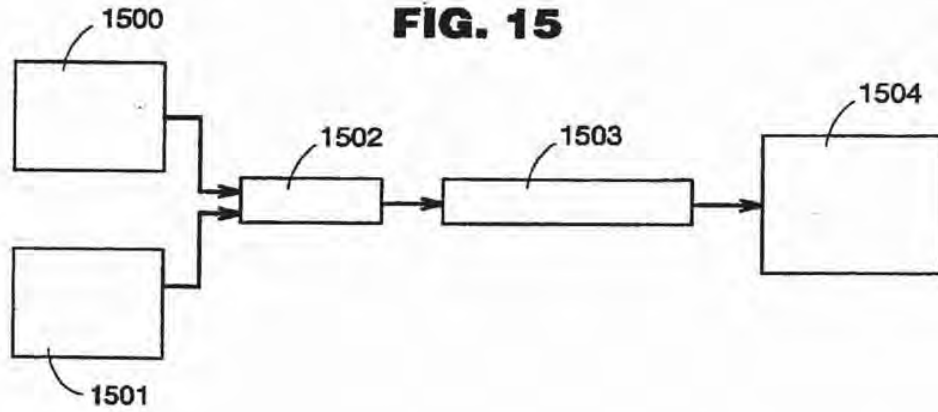

FIG. 16

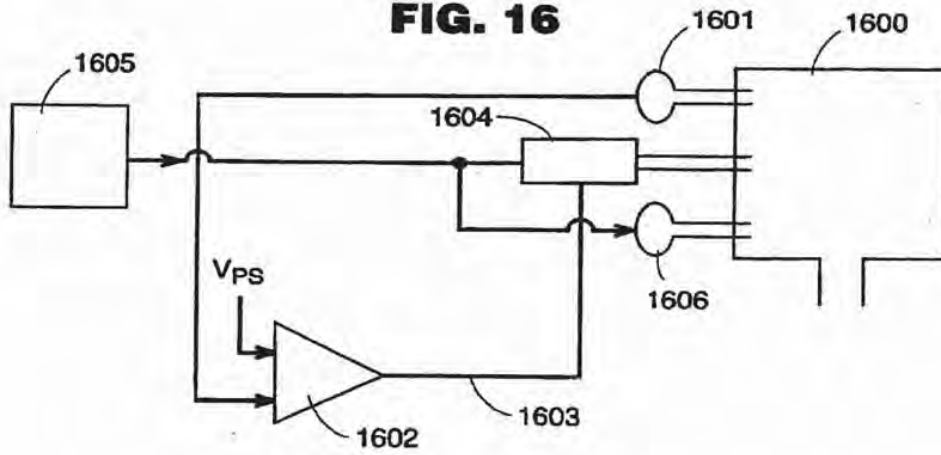
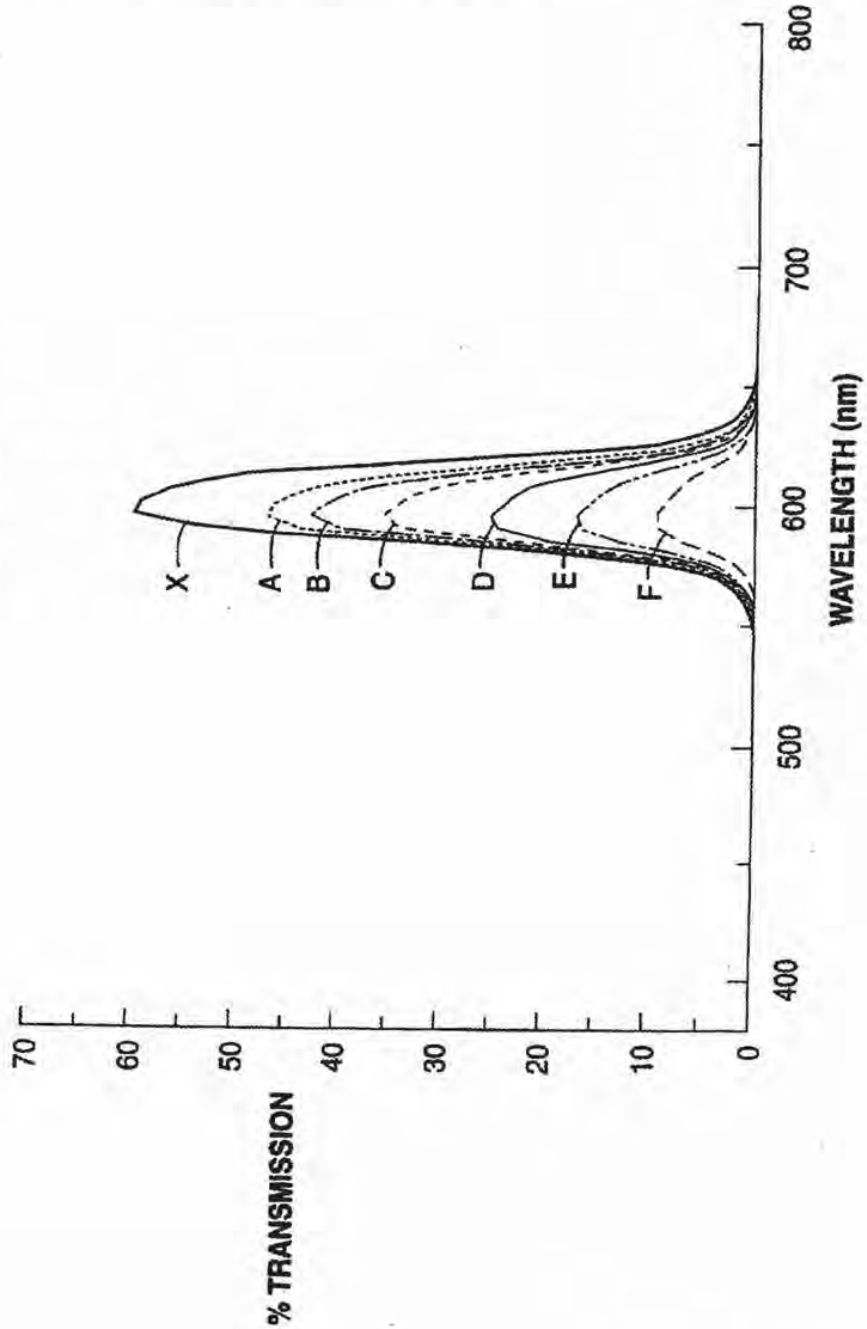

FIG. 17



ELECTROCHROMIC MIRRORS AND DEVICES

RELATED UNITED STATES PATENT APPLICATION

This application is a continuation-in-part of U.S. patent application Ser. No. 08/238,521, filed May 5, 1994, now U.S. Pat. No. 5,668,663.

BACKGROUND OF THE INVENTION

TECHNICAL FIELD OF THE INVENTION

The present invention relates to electrochromic devices for continuously varying the transmissivity to light suitable for use in, for example, electrochromic rearview mirrors, windows and sun roofs for motor vehicles, manufactured from electrochromic solid films and electrolytes containing redox reaction promoters and alkali ions and/or protons.

BRIEF DESCRIPTION OF THE RELATED TECHNOLOGY

Prior to the introduction of electro-optic mirrors into the automotive marketplace, prismatic rearview mirrors were available to drivers of motor vehicles to determine the whereabouts of neighboring motor vehicles to their rearward surroundings. By using a manual lever located on such mirrors, a driver of a motor vehicle, especially at dusk or later, would be able to employ a prismatic feature on the mirror to vitiate the effect of headlamp glare (the principal source of incoming electromagnetic radiation from the rear of the motor vehicle) from the low beam, and especially high beam, lighting elements of other motor vehicles travelling posterior thereto. Should the lever be flipped to the nighttime position, the driver would be able to view an image in a reflection from a glass-to-air interface on the first surface of the mirror. The light reflected from this first surface would exhibit non-spectral selectivity. That is, the background of any image viewed in the nighttime position of the prismatic mirror would be a neutral color. Such conventional prismatic mirrors are still used on a majority of motor vehicles in the United States today.

With the advent of electro-optic technology, such as electrochromic technology, it has become possible to achieve continuous variability in reflectivity in rearview mirrors for motor vehicles. This continuous variability has been achieved, for example, through the use of reversibly variable electrochromic devices, wherein the intensity of light (e.g., visible, infrared, ultraviolet or other distinct or overlapping electromagnetic radiation) is modulated by passing the light through an electrochromic medium. In such devices, the electrochromic medium is disposed between two conductive electrodes and undergoes electrochromism when potential differences are applied across the two electrodes.

Some examples of these prior art electrochromic devices are described in U.S. Pat. No. 3,280,701 (Donnelly); U.S. Pat. No. 3,451,741 (Manos); U.S. Pat. No. 3,806,229 (Schoot); U.S. Pat. No. 4,465,339 (Baucke); U.S. Pat. No. 4,712,879 (Lynam) ("Lynam I"); U.S. Pat. No. 4,902,108 (Byker) ("Byker I"); Japanese Patent Publication JP 57-30,639 (Negishi) ("Negishi I"); Japanese Patent Publication JP 57-208,530 (Negishi) ("Negishi II"); and I. F. Chang, "Electrochromic and Electrochemichromic Materials and Phenomena", in *Nonemissive Electrooptic Displays*, 155-96, A. R. Kmetz and F. K. von Willisen, eds., Plenum Press, New York (1976).

Numerous devices using an electrochromic medium wherein the electrochromism takes place entirely in a liquid solution are known in the art [see e.g., U.S. Pat. No. 5,128,799 (Byker) ("Byker II"); Donnelly, Manos, Schoot and Byker I; and commonly assigned U.S. Pat. No. 5,073,012 (Lynam) ("Lynam II"); U.S. Pat. No. 5,115,346 (Lynam) ("Lynam III"); U.S. Pat. No. 5,140,455 (Varaprasad) ("Varaprasad I"); U.S. Pat. No. 5,142,407 (Varaprasad) ("Varaprasad II"); U.S. Pat. No. 5,151,816 (Varaprasad) ("Varaprasad III"); U.S. Pat. No. 5,239,405 (Varaprasad) ("Varaprasad IV"); and commonly assigned co-pending U.S. patent application Ser. No. 07/935,784 (filed Aug. 27, 1992) and Ser. No. 08/061,742 (filed May 17, 1993)]. Typically, these electrochromic devices, sometimes referred to as electrochemichromic devices, are single-compartment, self-erasing, solution-phase electrochromic devices. See e.g., Manos, Negishi II, Byker I and Byker II.

In single-compartment, self-erasing, solution-phase electrochromic devices, the intensity of the electromagnetic radiation is modulated by passing through a solution of the color-forming species held in a single-compartment. The color-changing reaction occurs only in this solution-phase. That is, there is no solid material present in the devices that has the color-changing reaction in it. During operation of such devices, the solution of the color-forming species is liquid or fluid, although it may be gelled or made highly viscous with a thickening agent, and the components of the solution do not precipitate. See e.g., Byker I and Byker II.

Numerous devices using an electrochromic medium wherein the electrochromism occurs in a solid layer are also widely described in the art. Among such devices are those that employ electrochromic thin film technology [see e.g., N. R. Lynam, "Electrochromic Automotive Day/Night Mirrors", *SAE Technical Paper Series*, 870636 (1987); N. R. Lynam, "Smart Windows for Automobiles", *SAE Technical Paper Series*, 900419 (1990); N. R. Lynam and A. Agrawal, "Automotive Applications of Chromogenic Materials", *Large Area Chromogenics: Materials & Devices for Transmittance Control*, C. M. Lampert and C. G. Graessli, eds., Optical Eng'g Press, Washington (1990); C. M. Lampert, "Electrochromic Devices and Devices for Energy Efficient Windows", *Solar Energy Materials*, 11, 1-27 (1984); Japanese Patent Document JP 58-30,729 (Kamimori) ("Kamimori I"); U.S. Pat. No. 3,521,941 (Deb); U.S. Pat. No. 3,807,832 (Castellion); U.S. Pat. No. 4,174,152 (Giglia); U.S. Pat. No. Re. 30,835 (Giglia); U.S. Pat. No. 4,338,000 (Kamimori) ("Kamimori II"); U.S. Pat. No. 4,652,090 (Uchikawa); U.S. Pat. No. 4,671,619 (Kamimori) ("Kamimori III"); U.S. Pat. No. 4,702,566 (Tukude); Lynam I and commonly assigned U.S. Pat. No. 5,066,112 (Lynam) ("Lynam IV") and U.S. Pat. No. 5,076,674 (Lynam) ("Lynam V").

In thin film electrochromic devices, an anodic electrochromic layer and/or a cathodic electrochromic layer, each layer usually made from inorganic metal oxides or polymer films, may be separate and distinct from one another. In contrast to the single-compartment, self-erasing, solution-phase devices referred to supra, these thin film electrochromic devices modulate the intensity of electromagnetic radiation by passing through the individual anodic electrochromic layer and/or cathodic electrochromic layer.

In certain thin film electrochromic devices, a thin film layer of a solid electrochromic material, such as a tungsten oxide-type solid film, may be placed in contact with a liquid electrolyte containing redox promoters, such as ferrocene and iodide, and a solvent. See e.g., Kamimori III. In these electrochromic devices, the intensity of electromagnetic

radiation is primarily modulated by passing through the solid electrochromic material. When dimmed to a colored state, these tungsten oxide-type solid films typically dim to a blue-colored state.

Having grown accustomed to conventional prismatic rearview mirrors for motor vehicles, some consumers of motor vehicles may show a preference for rearview mirrors possessing substantial non-spectral selectivity. That is, some consumers may prefer mirrors which present a substantially gray color when dimmed to a colored state; in other words, a mirror that exhibits a viewing background comparable in spectral reflectivity to that of conventional prismatic mirrors.

On another note, the reflective element of the mirror is often constructed from silver and is typically situated on the rearmost surface of the mirror. That is, the reflective element is placed on the surface of a glass substrate farthest from that surface which first comes in contact with incident light. However, such placement has certain disadvantages. For instance, double imaging is a recognized problem in such mirror construction. In addition, in its path to reaching the reflective element of the mirror, incident light must first pass through each of the glass substrates of the mirror assembly. Therefore, in these mirror constructions, to achieve good optical performance, higher quality glass should be used for both substrates. Moreover, these mirror constructions typically require the use of a thin film transparent conductive electrode coating on the inward surface of each substrate in order to apply a potential to the electrochromic element. Requiring each substrate of the mirror to be of such higher quality glass and the use of two such transparent conductive electrodes increases material and production costs. Further, placement of the reflective element on the rearmost surface of the mirror requires an additional manufacturing step, which also increases production costs. And, such placement increases material and production costs due to necessary measures taken to protect the reflective element (typically, a highly reflective material, such as silver or aluminum) against environmental degradation, such as through the use of a paint or the like. Frequently, lead-based paints have been used for this purpose, thereby presenting environmental concerns.

It has been suggested and attempts have been made to place the reflective element of the mirror, such as silver, on the inward facing surface of the rear substrate so as to act as a conductive electrode coating as well as a reflective element. See e.g., Donnelly, Nigishi I, Byker I and Byker II. This configuration is plainly attractive since it eliminates the need for a separate transparent conductive coating on the rear substrate, thereby reducing the cost of manufacture.

In order to function in the dual role of reflective element and conductive electrode, a coating must (1) be electrochemically stable so as not to degrade during operation of the device, (2) remain securely adhered to the rear substrate to maintain the integrity of the device, and (3) be highly reflective so that the mirror as a whole will have an acceptable level of reflectance. However, no known mirror construction meets all of these requirements—for example silver, commonly used as the reflective element in conventional mirror constructions, is highly reflective but is not electrochemically stable and is difficult to adhere to the surface of a glass substrate. Other materials, such as rhodium or Inconel, which have been used as a combined reflective element and conducting electrode in prior art mirrors are not sufficiently reflective to provide a highly reflective electrochromic mirror. Perhaps for these reasons, the prior art suggestions and attempts have not resulted in

any commercially successful electrochromic mirror in which a single coating is used as both reflective element and conducting electrode.

Electrochromic devices, such as those using a solid film electrochromic material, like tungsten oxide, may also exhibit deleterious performance when exposed to ultraviolet radiation over prolonged periods of time (e.g., conditions typically encountered during outdoor weathering). This deleterious performance may be linked to any of a variety of sources, including a potential propensity for photochromism to occur.

On yet another note, displays, indicia and sensors, such as photo sensors, motion sensors, cameras and the like, have heretofore been incorporated into certain electrochromic mirror constructions [see e.g., U.S. Pat. No. 5,189,537 (O'Farrell) and U.S. Pat. No. 5,285,060 (Larson)]. In these constructions, the reflective element of the mirror has been locally removed to create a highly transmissive local window. However, such use of displays and the like positioned behind the reflective element of electrochromic mirrors has been limited. One reason for this limited use is due to diminished rear vision capability in that portion of the reflective element of the mirror which has been removed. Moreover, the displays and the like known to date may be distracting as well as aesthetically non-appealing to the driver and/or passengers of motor vehicles insofar as they may be visible and observable within the mirror mounted in the motor vehicles when in the inactivated state. In addition, the known methods of incorporating such displays and the like into mirrors have been only partially successful, labor intensive and economically unattractive from a manufacturing standpoint.

Further, although it has been suggested to use semi-transparent reflectors in rearview mirrors [see e.g., U.S. Pat. No. 5,014,167 (Roberts) ("Roberts I") and U.S. Pat. No. 5,207,492 (Roberts) ("Roberts II")], previous attempts have included the use of dichroic reflectors which are complex to design and expensive to fabricate. Also, where use of metallic reflectors has been suggested [see e.g., U.S. Pat. No. 4,588,267 (Pastore)], it has been in the context of conventional mirrors such as prismatic mirrors. These suggestions fail to recognize the problems that must be overcome to provide a highly reflecting and partially transmitting electrochromic rearview mirror.

Therefore, the need exists for an electrochromic mirror that provides substantial non-spectral selectivity when dimmed to a colored state, akin to that exhibited by conventional prismatic mirrors when in the nighttime position, along with continuous variability in reflectivity, ease and economy of manufacture and enhanced outdoor weathering resilience. It would also be desirable, particularly in this connection, to have an electrochromic mirror construction that reduces material and manufacturing costs by employing as only one of its substrates a high quality glass as a substrate and also as only one of its electrodes a thin film, substantially transparent conductive electrode coating. In addition, it would be desirable for a mirror to have display-on-demand capability where a display could become activated to be viewed on demand, and where the display is (1) aesthetically appealing and not distracting in its inactivated state, and (2) is manufactured with ease and economy.

SUMMARY OF THE INVENTION

The present invention meets the needs expressed above concerning the desirability of a substantially non-spectral selective electrochromic mirror by providing such an elec-

trochromic mirror that exhibits substantially non-spectral selectivity in the form of a substantially neutral or neutral gray appearance when dimmed to a color state by the introduction of an applied potential. The electrochromic element of this mirror comprises an electrochromic solid film and an electrolyte, which itself comprises redox reaction promoters and alkali ions and/or protons.

Another aspect of the present invention provides a commercially practicable electrochromic mirror having a novel construction. More specifically, this novel mirror construction provides a layer of reflective material coated on the inward surface of the second substrate which also serves as a conductive electrode coating. The layer of reflective material is overcoated with an electrochromic solid film and may also be undercoated to promote its adhesion to the substrate.

This construction employs a higher quality glass for only one of its substrates and employs for only that substrate made from a higher quality glass a conductive electrode coating that is substantially transparent. That is, the construction permits the use of (1) a lower quality glass as the second or rearmost substrate while maintaining good optical performance in the mirror; (2) a higher resistance, and hence more economical, conductive electrode coating for the first or frontmost substrate which is made from a higher quality glass; and (3) only one substantially transparent conductive electrode coating (to be used on the inward surface of the first substrate made from a higher quality glass), which further reduces material costs incurred in the manufacture of such mirrors.

In addition, the layer of reflective material in this novel construction reduces further still the material and production costs associated with such mirrors since it serves the additional role of a conductive electrode coating thereby obviating manufacturing costs associated with a separate substantially transparent conductive electrode coating. Moreover, in this construction, the reflective element of the mirror is located within, and protected by, the sealed cavity which forms the electrochromic element of the mirror. The reflective element of the mirror is thus protected from degradation through environmental exposure without having to resort to the use of protective materials, such as lead-based overcoating paints or the like. The novel construction of this electrochromic mirror also enhances the resistance of the reflective material to physical, chemical and/or electrochemical degradation. Further, the construction so provided also reduces image separation which can lead to the recognized problem of double imaging.

In addition, another aspect of the invention provides an "on demand display" for mirrors, as described hereinafter. The mirror construction referred to supra and described in detail hereinafter, facilitates placement of displays, indicia and sensors and the like behind the mirror element so that they may be viewed as an "on demand display".

As stated supra, the electrochromic mirrors of the present invention exhibit a substantially gray appearance when dimmed to a colored state upon the introduction of an applied potential. The coloring capability of these mirrors determines the extent to which glare may be reflected from the mirrors. As with other electrochromic mirrors, this coloring capability may be continuously varied by controlling the magnitude, duration and polarity of the applied potential introduced thereto. The appearance of the substantially gray color may be appealing to consumer preferences (especially to certain drivers of motor vehicles which employ these mirrors) and to commercial design and manufacture concerns by virtue of its substantial color neutrality

relative to the color of the housing, casing, structure, machine, instrument or vehicle with which it is to be used. That is, even when dimmed to a colored state, the electrochromic mirrors of the present invention are often aesthetically complementary to the color of the other component(s) with which they are to be used.

The electrochromic mirrors of the present invention are suitable for use as electrochromic rearview mirrors (e.g., truck mirrors, interior and exterior mirrors for motor vehicles), architectural mirrors or specialty mirrors, like those useful in aeronautical, periscopic or dental and medical applications.

In addition to electrochromic mirrors, electrochromic devices, such as electrochromic glazings (e.g., architectural glazings, like those useful in the home, office or other edifice; aeronautical glazings, such as those which may be useful in aircraft; or vehicular glazings, for instance, windows, like windshields, side windows and backlights, sun roofs, sun visors or shade bands); electrochromic optically attenuating contrast filters, such as contrast enhancement filters, suitable for use in connection with cathode ray tube monitors and the like; electrochromic privacy or security partitions; electrochromic solar panels, such as sky lights; electrochromic information displays; and electrochromic lenses and eye glass, may also benefit from that which is described herein, especially where substantially non-spectral selective coloring is desired.

Thus, the present invention exemplifies an advance in the art that will become readily apparent and more greatly appreciated by a study of the detailed description taken in conjunction with the figures which follow hereinafter.

BRIEF DESCRIPTION OF THE FIGURES

FIG. 1 depicts a spectral scan of percent reflectance versus wavelength in nanometers of an electrochromic mirror according to the present invention when in its bleached state.

FIG. 2 depicts a spectral scan of percent reflectance versus wavelength in nanometers of an electrochromic mirror according to the present invention when dimmed to a neutral colored state.

FIG. 3A depicts a perspective view of an electrochromic mirror—i.e., an interior rearview automobile mirror—according to the present invention.

FIG. 3B depicts a cross-sectional view of the electrochromic mirror of FIG. 3A.

FIG. 4 depicts another cross-sectional view of the electrochromic mirror of FIGS. 3A and 3B.

FIG. 5 depicts a cross-sectional view of another electrochromic mirror construction according to the present invention. In this construction, a secondary weather barrier 12 has been applied to the joint at which sealing means 5 joins substrates 2,3.

FIG. 6 depicts a cross-sectional view of still another electrochromic mirror construction according to the present invention. This mirror construction is similar to the mirror construction of FIG. 5, except that an adhesion promoter 11 is coated between substrate 3 and conductive electrode coating 4.

FIG. 7 depicts a cross-sectional view of yet another electrochromic mirror construction according to the present invention.

FIG. 8 depicts a perspective view of an electrochromic mirror constructed with an on demand display.

FIG. 9 depicts a cross-sectional view of an electrochromic mirror constructed with an on demand display using a glass cover sheet over the display window in the mirror construction.

FIG. 10 depicts a cross-sectional view of another electrochromic mirror constructed with an on demand display.

FIGS. 11A, B and C depict the orientation of the substrates in different constructions of the electrochromic mirrors and electrochromic devices of the present invention. FIG. 11A depicts a perpendicular displacement of the first substrate and the second substrate. FIG. 11B depicts a lateral displacement and a perpendicular displacement of the first substrate and the second substrate. FIG. 11C depicts an arrangement of the first substrate and the second substrate, wherein the dimensions of the length and width of the first substrate are slightly greater than those of the second substrate. In this arrangement, the peripheral edge of the first substrate extends beyond the peripheral edge of the second substrate.

FIG. 12 depicts a perspective view of an electrochromic mirror constructed with turn signal indicia.

FIG. 13 depicts a perspective view of a multi-radius electrochromic mirror according to the present invention.

FIGS. 14A and B depict cross-sectional views of electrochromic devices, which illustrate different seal constructions that may be employed in accordance with the present invention.

FIG. 15 is a schematic diagram of a synchronous manufacturing process for electrochromic mirrors according to the present invention.

FIG. 16 is a schematic diagram of a constant pressure control system useful for evaporative deposition of solid electrochromic films.

FIG. 17 is a plot of percent transmission versus wavelength for a continuously variable intensity filter fixed to the glass of the electrochromic window cell for voltages applied to the electrochromic medium within the range of from about 0 volts to about 1.4 volts. In FIG. 17, solid curve X represents the percent transmission versus wavelength (nm) spectrum for a 600 nm medium-band interference filter having a bandwidth of about 40 nm. Curve A represents light transmission through the band pass filter and the electrochromic window cell with no potential applied. Curve B represents light transmission through the band pass filter and the electrochromic window cell at an applied potential of about 0.3 volts. Curve C represents light transmission through the band pass filter and the electrochromic window cell at an applied potential of about 0.5 volts. Curve D represents light transmission through the band pass filter and the electrochromic window cell at an applied potential of about 0.8 volts. Curve E represents light transmission through the band pass filter and the electrochromic window cell at an applied potential of about 1.1 volts. And curve F represents light transmission through the band pass filter and the electrochromic window cell at an applied potential of about 1.4 volts.

The depictions in these figures are for illustrative purposes only and are not drawn to scale. Unless otherwise indicated, in the following detailed description of the invention the element numbers discussed are descriptive of like elements of all figures.

DETAILED DESCRIPTION OF THE INVENTION

In accordance with the teaching of the present invention, there are provided electrochromic mirrors, such as electrochromic rearview mirrors for a motor vehicle. These mirrors are constructed from a first substantially transparent substrate with a substantially transparent conductive electrode

coating on its inward surface and a second substrate, which may or may not be substantially transparent, with a conductive electrode coating, which also may or may not be substantially transparent, on its inward surface. Whether the second substrate and the conductive electrode coating thereon are or are not substantially transparent will depend on the particular construction of the mirror.

The first substrate and second substrate may be positioned in spaced-apart relationship with one another, being substantially parallel or substantially tangentially parallel depending upon whether the substrates are flat or bent. These substrates may also be laterally displaced from, or in a substantially flush relationship with, one another. The substrates may also have respective dimensions such that one of the substrates is sized and shaped to have a slightly greater length and width than the other substrate. Thus, when the substrates are positioned in central alignment with one another, the peripheral edges of the slightly larger substrate extend beyond the peripheral edges of the slightly smaller substrate.

The mirrors have a layer of reflective material coated either onto (a) the rearmost (non-inward) surface of the second substrate, where it serves a single role as a reflective element of the mirror or (b) the inward surface of the second substrate, where it serves a dual role as a conductive electrode coating and a reflective element of the mirror.

In these mirrors, an electrochromic solid film is coated either onto (a) the transparent conductive electrode coating of the first substrate, (b) the layer of reflective material when acting as a conductive electrode coating on the inward surface of the second substrate or (c) the substantially transparent conductive electrode coating on the inward surface of the second substrate, when the layer of reflective material is placed on the rearmost (non-inward) surface of the second substrate.

A sealing means is positioned toward the peripheral edge of each of the first substrate and the second substrate to form a cavity, in which is located, either in a liquid-phase or a solid-phase, an electrolyte comprising redox reaction promoters and alkali ions and/or protons. In the cavity, the electrolyte is in contact with the electrochromic solid film (which itself is in contact with a conductive electrode coating on the inward surface of one of either the first substrate or second substrate) and a conductive electrode coating (on the inward surface of the other of the first substrate or second substrate) to form an electrochromic element.

Finally, a means for introducing an applied potential to the electrochromic element is also provided to controllably vary the amount of light reflected from the mirror.

Decreased light transmissivity in the electrochromic devices of the present invention (and reflectivity in the electrochromic mirrors) is primarily provided by the color-forming reaction that occurs in the electrochromic solid film. This electrochromic solid film may be a thin film layer of an inorganic transition metal oxide. Stoichiometric and substoichiometric forms of transition metal oxides, such as Group IV-B, V-B or VI-B oxides like tungsten oxide, molybdenum oxide, niobium oxide, vanadium oxide, titanium dioxide and combinations thereof, may be used. Other conventional inorganic transition metal oxides, such as those recited in Kamimori III, may also be employed. Preferably, however, tungsten oxide or doped tungsten oxide, with suitable dopants including molybdenum, rhenium, tin, rhodium, indium, bismuth, barium, titanium, tantalum, niobium, copper, cerium, lanthanum, zirconium, zinc,

nickel, and the like, may be used as the electrochromic solid film. A beneficial effect of the addition of the dopant may be to move the spectral absorption edge of the doped tungsten oxide coating farther into the visible range of the electromagnetic spectrum.

Where doped tungsten oxide is used, the dopant should be present in a concentration within the range of from about 0.1% (by mole) to about 20% (by mole) or even greater. Preferred doped tungsten oxides include those where a molybdenum dopant is used within the range of about 0.5% (by mole) to about 10% (by mole).

The electrochromic solid film may be a stack of thin films, such as a layer of tungsten oxide overcoated and/or undercoated with a thin film like silicon dioxide, titanium dioxide, tantalum pentoxide or cerium oxide. Such overcoats and/or undercoats may help promote enhanced adhesion of the tungsten oxide electrochromic solid film to its substrate and/or passivate it from the electrolyte which it contacts in the electrochromic element.

When the electrochromic solid film comprises a stack of thin films, the layers of the multiple layer stack may individually comprise an electrochromic material. For example, a stacked electrochromic solid film can be formed by coating an electrochromic layer of molybdenum oxide onto a transparent conductor coated substrate (to a thickness of, for example, about 100 Å to about 3,000 Å), and by overcoating (and/or undercoating) the molybdenum oxide electrochromic layer with another electrochromic solid film layer, such as tungsten oxide having a thickness, for example, in the range of about 100 Å to about 5,000 Å. Alternatively, multiple layers of tungsten oxide and layers of molybdenum oxide can be used to form a stacked electrochromic solid film.

When evaporating molybdenum oxide, it may be useful to melt-process the molybdenum oxide powder prior to evaporation. Since molybdenum oxide melts at about 795° C., molybdenum oxide powder (typically about 100 mesh) may be placed into a suitable high temperature resistant, inert evaporation crucible (such as an alumina crucible) and converted to a solid mass by heating to a temperature within the range of about 850° C. to about 900° C. for a period of time of about 60 minutes in a high temperature furnace, preferably in an inert atmosphere such as a nitrogen atmosphere. Since molybdenum oxide melts at a lower temperature (less than about 1,000° C.) compared to other electrochromic metal oxides such as tungsten oxide that melt at a temperature greater than about 1,000° C., molybdenum oxide (and equivalent lower melting metal oxides) may be used as a binder for evaporation of high melt temperature metal oxide powders.

The thickness of the electrochromic solid film may be within the range of from about 0.05 μm to about 1.0 μm or greater, with about 0.25 μm to about 0.75 μm being preferred, and about 0.3 μm to about 0.6 μm being more preferred.

The electrochromic solid film may have a microstructure that is amorphous, crystalline, polycrystalline or combinations thereof. In electrochromic devices where the occurrence of photochromism is a concern, it may be desirable for the electrochromic solid film to possess a microstructure that is at least partially crystalline. Such a crystalline microstructure is believed to minimize the photochromic effect, which may be deleterious to the operation of the electrochromic devices. It may also be desirable for the electrochromic solid film to possess a microstructure that is porous. In this connection, it may be desirable for the electrochromic solid

film, such as tungsten oxide or doped tungsten oxide, to have a density of less than about 90%, preferably less than about 80%, of the density of the bulk oxide.

The electrolyte useful in the electrochromic element of the electrochromic mirrors of the present invention should comprise redox reaction promoters, and alkali ions and/or protons. The electrolyte may be in a liquid-phase or in a solid-phase.

The redox reaction promoters of the electrolyte comprise two individual species, a metallocene and a phenothiazine used in combination.

The metallocenes suitable for use as a redox reaction promoter in the present invention are represented by the following structure:

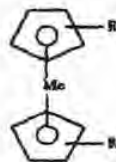

metallocenes and their derivatives

wherein R and R₁ may be the same or different, and each may be selected from the group consisting of H; any straight- or branched-chain alkyl constituent having from about 1 carbon atom to about 8 carbon atoms, such as CH₃, CH₂CH₃, CH₂CH₂CH₃, CH(CH₃)₂, C(CH₃)₃ and the like; acetyl; vinyl; allyl; hydroxyl; carboxyl; -(CH₂)_n-OH; wherein n may be an integer in the range of 1 to about 8; -(CH₂)_n-COOR₂, wherein n may be an integer in the range of 1 to about 8 and R₂ may be any straight- or branched-chain alkyl constituent having from about 1 carbon atom to about 8 carbon atoms, hydrogen, lithium, sodium,

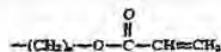

wherein n' may be an integer in the range of 2 to about 8, or

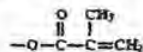

wherein n' may be an integer in the range of 2 to about 8; -(CH₂)_n-OR₃, wherein n may be an integer in the range of 1 to about 8 and R₃ may be any straight- or branched-chain alkyl constituent having from about 1 carbon atom to about 8 carbon atoms,

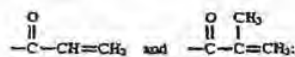

or -(CH₂)_n-N+(CH₃)₃ X⁻, wherein n may be an integer in the range of 1 to about 8 and X may be Cl⁻, Br⁻, I⁻, ClO₄⁻ or BF₄⁻; and M₁ is Fe, Ni, Ru, Co, Ti, Cr and the like.

The phenothiazines suitable for use as a redox reaction promoter in the present invention include, but are not limited to, those represented by the following structure:

11



wherein R_4 may be selected from the group consisting of H; any straight- or branched-chain alkyl constituent having from about 1 carbon atom to about 10 carbon atoms; phenyl; benzyl; $-(CH_2)_2-CN$; $-(CH_2)_2-COOH$;

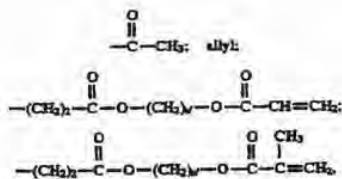

wherein n may be an integer in the range of 2 to about 8;

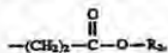

wherein R_2 may be any straight- or branched-chain alkyl constituent having from about 1 carbon atom to about 8 carbon atoms; and

$R_3, R_6, R_7, R_8, R_9, R_{10}, R_{11}, R_{12}$ may be selected from H, Cl, Br, CF_3 , CH_3 , NO_2 , $COOH$, SCH_3 , OCH_3 , O_2CCH_3 , or



R_4 and R_{12} , when taken together, form a ring with six atoms (five of which being carbon) having a carbonyl substituent on one of the carbon atoms.

Preferred among phenothiazines II is phenothiazine III as depicted in the following structure:

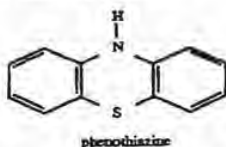

Other desirable phenothiazines II include:



12

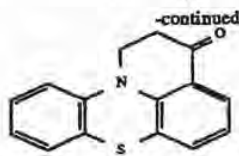

2,3-dihydro-3-keto-1H-pyrido[3,2,1-f]phenothiazine
("C-PT")

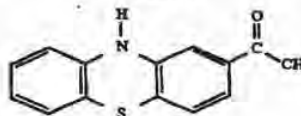

1-acetyl-phenothiazine
("APT")

An example of a desirable quinone for use as a redox promoter in the present invention is

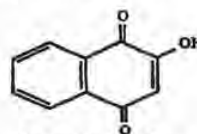

2-hydroxy-naphthoquinone

Combinations of redox reaction promoters may be selectively chosen to achieve a desired substantially non-spectral selectivity when the electrochromic element (and the mirror in which the electrochromic element is to function) is dimmed to a colored state.

The redox reaction promoters may be present in the electrolyte in a total concentration of about 0.005M to about 0.5M, with a total concentration of about 0.02M to about 0.1M being preferred. The ratio of this combination (i.e., total metallocene to total phenothiazine) should be within the range of about 1:1 to about 1:10, with a preferred combination of redox reaction promoters being ferrocene and phenothiazine (III) in about a 1:2 (by mole) to about a 1:4 (by mole) ratio and, more preferably, having a total concentration of about 0.07M to about 0.09M.

A source of alkali ions may also be included in the electrolyte. Suitable sources of alkali ions are lithium salts, such as lithium perchlorate ("LiClO₄"), lithium tetrafluoroborate ("LiBF₄"), lithium iodide ("LiI"), lithium hexafluorophosphate ("LiPF₆"), lithium hexafluoroarsenate ("LiAsF₆"), lithium styrylsulfonate ("LiSS"), lithium trillate ("LiCF₃SO₃"), lithium methacrylate, lithium halides other than LiI, such as lithium chloride ("LiCl"), lithium bromide ("LiBr") and the like, lithium trifluoroacetate ("CF₃COOLi") and combinations thereof. Of these, LiClO₄ or combinations of LiClO₄ and LiBF₄ are preferred. These sources of alkali ions may be present in the electrolyte in a concentration of about 0.01M to about 1.0M, with a concentration of about 0.05M to about 0.1M being preferred.

A source of protons may also be included in the electrolyte, by, for example, incorporating into the electrolyte water (for example, in a concentration of less than about 5% (v/v), preferably in a concentration within the range of about 0.5% (v/v) to about 2% (v/v)), or by incorporating into the electrolyte organic acids, inorganic acids or other protonic sources suitable for use in conjunction with organic solvents as are known in the art.

The electrolyte itself may be in a liquid-phase or a solid-phase, however, where the electrolyte is in a liquid-

phase, a suitable solvent for use in the electrolyte may solubilize the redox reaction promoters and alkali ions (and other optional components such as ultraviolet stabilizing agents which absorb and/or screen ultraviolet radiation) while remaining substantially inert thereto (as well as to any other optional components in the electrolyte). Any material that remains in its liquid form over the range of temperatures to which the devices manufactured with the electrolytes of the present invention will likely be subjected is suitable for use as a solvent in a liquid-phase electrolyte [for a non-exhaustive recitation of such solvents, see e.g., Varaprasad I and Varaprasad III]. Practically speaking, the solvent may be an organic solvent, preferably a substantially non-aqueous organic solvent, which is stable to electrolysis and other phenomena likely to be encountered during the practice of this invention.

Suitable solvents may be selected from acetonitrile, 3-hydroxypropionitrile, methoxypropionitrile, 3-ethoxypropionitrile, 2-acetylbutyrolactone, propylene carbonate, ethylene carbonate, glycerine carbonate, tetramethylene sulfone, cyanoethyl sucrose, γ -butyrolactone, 2-methylglutaronitrile, N,N'-dimethylformamide, 3-methylsulfone, glutaronitrile, 3,3'-oxydipropionitrile, methylethyl ketone, cyclopentanone, cyclohexanone, benzoyl acetone, 4-hydroxy-4-methyl-2-pentanone, acetophenone, 2-methoxyethyl ether, triethylene glycol dimethyl ether, 4-ethenyl-1,3-dioxalane-2-one, 1,2-butylene carbonate, glycidyl ether carbonates (such as those commercially available from Texaco Chemical Company, Austin, Tex.) and combinations thereof, preferred of which include propylene carbonate, 1,2-butylene carbonate, the combination of tetramethylene sulfone and propylene carbonate and the combination of 1,2-butylene carbonate and propylene carbonate.

Where the electrolyte of the present invention is desirably a solid-phase electrolyte, a formulation of starting components may be in situ transformed such as by polymerization reaction through, for instance, exposure to ultraviolet radiation or application of thermal energy, to produce a solid electrolyte. In the context of ultraviolet radiation activated polymerization, ultraviolet polymerizable components [such as those taught by and described in commonly assigned co-pending U.S. patent application Ser. No. 08/023,675, filed Feb. 26, 1993 (now abandoned) ("the '675 application") and Ser. No. 08/193,557, filed Feb. 8, 1994 ("the '557 application"), the disclosures of each of which are incorporated herein by reference] may be used to transform into a solid-phase electrolyte when exposed to ultraviolet radiation.

Other components may also be added to the electrolyte, with such components preferably being in solution in liquid-phase electrolytes. These components may include, but are not limited to, ultraviolet stabilizing agents, infrared radiation reducing agents, color tinting agents (e.g., dyes or colorants) and combinations thereof. Suitable ultraviolet stabilizing agents and color tinting agents are recited in Lynam III, the disclosure of which is hereby incorporated herein by reference. For example, a blue-colored dye of the phthalocyanine-type, such as "NEOPEN" 808 (commercially available from BASF Corp., Parsippany, N.J.), may be added to the electrolyte as a color tinting agent.

Because many redox reaction promoters show a substantial absorbance in the ultraviolet region of the electromagnetic spectrum from about 250 nm to about 350 nm and the electrochromic solid film itself may be deleteriously affected by exposure to ultraviolet radiation, it is often desirable to

shield the redox reaction promoters and electrochromic solid film from ultraviolet radiation. Thus, by introducing an ultraviolet stabilizing agent to the electrolyte, or using a solvent which itself acts to absorb ultraviolet radiation, the lifetime of the electrochromic device may be extended. It may be particularly advantageous to include ultraviolet stabilizing agents in the electrolyte for electrochromic mirrors and electrochromic devices whose intended use may result in exposure to outdoor weathering conditions, such as that encountered by the exterior of a motor vehicle.

Although many materials known to absorb ultraviolet radiation may be employed herein, preferred ultraviolet stabilizing agents include "UVINUL" 400 [2,4-dihydroxybenzophenone (manufactured by BASF Corp., Wyandotte, Mich.)], "UVINUL" D 49 [2,2'-dihydroxy-4,4'-dimethoxybenzophenone (BASF Corp.)], "UVINUL" N 35 [ethyl-2-cyano-3,3-diphenylacrylate (BASF Corp.)], "UVINUL" N 539 [2-ethyl hexyl-2-cyano-3,3'-diphenylacrylate (BASF Corp.)], "UVINUL" M 40 [2-hydroxy-4-methoxybenzophenone (BASF Corp.)], "UVINUL" M 408 [2-hydroxy-4-octoxy-benzophenone (BASF Corp.)], "TINUVIN" P [2-(2H-benzotriazole-2-yl)-4-methylphenyl (manufactured by Ciba Geigy Corp., Hawthorne, N.Y.)], "TINUVIN" 327 [2-(3',5'-di-*t*-butyl-2'-hydroxyphenyl)-5-chloro-benzotriazole (Ciba Geigy Corp.)], "TINUVIN" 328 [2-(3',5'-di-*n*-pentyl-2'-hydroxyphenyl)-benzotriazole (Ciba Geigy Corp.)], "CYASORB" UV 24 [2,2'-dihydroxy-4-methoxy-benzophenone (manufactured by American Cyanamid Co., Wayne, N.J.)] and combinations thereof, where a suitable range of the ultraviolet stabilizing agents is from about 0.2% (w/v) to about 40% (w/v), with about 5% (w/v) to about 15% (w/v) being preferred. The ultraviolet stabilizing agent should be chosen with an eye toward avoiding an adverse affect on performance and electrolyte function.

In addition, ultraviolet absorbing interlayers may be coated onto, or adhered to, the first substrate and/or second substrate, particularly the first substrate, to assist in shielding the electrochromic element from the degradative effect of ultraviolet radiation. Suitable ultraviolet absorbing interlayers include those recited in Lynam III.

Moreover, to assist in extending the lifetime of the electrochromic device, the electrochromic solid film may be placed onto the inward surface of the second substrate—i.e., coated onto either the reflective element or the substantially transparent conductive electrode coating depending on the particular construction. Location of the electrochromic solid film on the inward surface of the second substrate may be desirable where an electrochromic rearview mirror suitable for use on the exterior of a motor vehicle is intended to be exposed to outdoor weathering, including exposure to ultraviolet radiation.

It may also be desirable to employ ultraviolet absorbing glass or laminates thereof for the first substrate or for the second substrate in an electrochromic mirror, particularly for the first substrate, or for the first substrate and/or the second substrate in an electrochromic device. Suitable ultraviolet absorbing glass include that which is recited in Lynam IV. In addition, it may be desirable to employ tin oxide, doped tin oxide, zinc oxide or doped zinc oxide as a substantially transparent conductive electrode coating on the inward surface of the first substrate, ultraviolet stabilizing agents in the electrolyte, ultraviolet absorbing interlayers, ultraviolet absorbing glass and combinations thereof in conjunction with positioning the electrochromic solid film on the inward surface of the second substrate. Such constructions, particularly with additional ultraviolet stabilizing agents included

in the electrolyte as described supra, facilitate screening and/or absorption of ultraviolet radiation by the components used in the electrochromic mirror or electrochromic device, including the first substrate, the conductive electrode coating thereon, and the electrolyte and its components that are positioned effectively in front of the potentially ultraviolet sensitive electrochromic solid film.

Addition of ultraviolet stabilizing agents may be particularly advantageous when the electrochromic solid film 7 is coated onto conductive electrode 4' on the inward surface of substrate 3. (See FIG. 5.) In this construction, the ultraviolet stabilizing agents may act to screen and/or absorb incident ultraviolet radiation before it reaches the electrochromic solid film 7. By so doing, the chance of irradiating the potentially photochromic or otherwise ultraviolet radiation vulnerable electrochromic solid film 7 may be reduced or even substantially eliminated. In contrast, when coated onto substantially transparent conductive electrode 4 on the inward surface of substrate 2 (see FIG. 4), the electrochromic solid film 7 may be directly irradiated by any incident ultraviolet light that passes through substrate 2. The ultraviolet screening and/or absorbing effect of the electrolyte, which in this construction is now positioned behind the electrochromic solid film 7, has less of an opportunity to shield the electrochromic solid film 7 from incident ultraviolet light (although the electrolyte may effectively absorb any ultraviolet light which is reflected from the reflective element on substrate

Those of ordinary skill in the art may make appropriate choices among the various materials available as described herein for the substrates, coatings, electrochromic solid films and electrolyte components—e.g., redox reaction promoters, sources of alkali ions and/or protons, solvents, and other components—to prepare electrochromic mirrors and electrochromic devices capable of generating a substantially non-spectral selective gray color suitable for the desired application. In addition, while glass is a suitable choice of material from which the substrates may be constructed, other materials may be used, such as optical plastics like acrylic, polycarbonate, polystyrene and allyl diglycol carbonate (commercially available from Pittsburgh Plastic Glass Industries, Pittsburgh, Pa. under the tradename "CR-39").

Reference to the figures will now be made in order to more faithfully describe the electrochromic devices, particularly the electrochromic mirrors, of the present invention.

With reference to FIGS. 3A, 3B and 4, it may be seen that the electrochromic element 1 includes a front substrate 2 and a rear substrate 3, each of which is typically glass. However, as described in detail hereinafter, in certain mirror constructions only the front or first substrate 2 needs to be at least substantially transparent, and in those constructions the rear or second substrate 3 need not be transparent at all. (See FIG. 5.) In fact, substrate 3 may be a polished metal plate, a metal-coated glass substrate or a conductive ceramic material.

By convention, the first substrate 2 (the frontmost or outermost substrate) is the substrate of the electrochromic device positioned closest to any principal source of incoming or incident electromagnetic radiation and, in an electrochromic mirror, the second substrate 3 is the substrate onto which a layer of reflective material 8 is coated. Put another way, the first substrate 2 is the substrate into which a driver of or passenger in a motor vehicle may first look through to view an image. In an electrochromic device, such as a glazing, a window or a sun roof for a motor vehicle, the first substrate 2 is the substrate exposed directly to, and often in

contact with, the outdoor environment and is exposed directly to solar ultraviolet radiation.

Substrates 2,3 should be positioned substantially parallel to one another if planar (or positioned substantially tangentially parallel to one another if bent), or as close to parallel (or tangentially parallel) to one another as possible so as to minimize image separation which may lead to double imaging. Double imaging is particularly noticeable when mirrors are colored to a dimmed state. Double imaging may be further minimized in mirror constructions as described hereinafter.

Onto each of the inward surfaces of substrates 2,3 is coated a conductive electrode coating 4 or 4'. The conductive electrode coatings 4,4' may be constructed from the same material or different materials, including transparent electronic conductors, such as tin oxide; indium tin oxide ("ITO"); half-wave indium tin oxide ("HW-ITO"); full-wave indium tin oxide ("FW-ITO"); doped tin oxides, such as antimony-doped tin oxide and fluorine-doped tin oxide; doped zinc oxides, such as antimony-doped zinc oxide and aluminum-doped zinc oxide, with tin oxide, doped tin oxide, zinc oxide or doped zinc oxide being preferred where long-term ultraviolet resilience is desired in the device.

In certain mirror constructions, the conductive electrode coating 4' need not be substantially transparent. Rather, the layer of reflective material that serves as the reflective element of the mirror (with any other coatings used to form a thin film stack) may also serve as conductive electrode coating 4', thereby allowing a potential to be applied to the electrochromic element 1. Suitable materials for this layer of reflective material include metals, such as aluminum, palladium, platinum, titanium, chromium, silver, nickel-based alloys and stainless steel, with a high reflector (having a reflectance greater than about 70%), like silver or aluminum, being preferred. However, where resistance to scratching and environmental degradation is a concern, a medium reflector (having a reflectance within the range of about 40% to about 70%), like chromium, stainless steel, titanium and nickel-based alloys, is preferred. As an alternative to the use of these metals as a reflective element, multi-coated thin film stacks of inorganic oxides, halides, nitrides or the like, or a thin film layer of high index material may also be used.

The conductive electrode coatings 4,4' may be thin films of metal, such as silver, aluminum and the like, with a thickness of less than about 200 Å, which may be as low as less than about 100 Å, so that the conductive electrode coatings 4,4' are sufficiently conductive yet sufficiently transmissive. It may be desirable to index match a thin film of metal through the use of a thin film layer of a transparent metal oxide, metal nitride, metal halide or the like, such as indium oxide, zinc oxide, tin oxide, magnesium fluoride, titanium nitride, silicon dioxide, tungsten oxide or titanium dioxide, either as an overcoat or an undercoat to the thin film of metal to assist in reducing its reflectance, and increasing its transmittance, of incident visible light [see e.g., commonly assigned U.S. Pat. No. 5,239,406 (Lynam) ("Lynam VI")].

For example, a layer of a metal, such as silver, preferably having a thickness of less than about 200 Å and a sheet resistance of less than about 12 ohms per square (more preferably, less than about 10 ohms per square, and most preferably, less than about 8 ohms per square), may be overcoated with a metal oxide transparent conductor [such as a thin film layer of indium oxide (itself either undoped or doped with tin to form indium tin oxide)] and/or undercoated with a metal oxide layer [such as a thin film layer of

indium oxide (itself either undoped or doped with tin to form indium tin oxide) to form a substantially transmitting multi-layer transparent conductor on a glass surface. The sheet resistance of the multi-layer transparent conducting stack is preferably less than about 10 ohms per square, more preferably less than about 8 ohms per square, and most preferably less than 6 ohms per square. The transmission of visible light through the multi-layer transparent conductor coated glass substrate (which ordinarily comprises glass/metal oxide/metal/metal oxide or glass/metal/metal oxide such that the outermost metal oxide layer overcoating the thin metal layer serves as a barrier coating to reduce or prevent direct contact between the potentially electrochemically vulnerable metal layer and any electroactive medium, such as an electrochemically active liquid, thickened liquid and the like, that contacts the multi-layer transparent stack) is preferably greater than about 70%, more preferably greater than about 80%, and most preferably greater than about 85%.

Though silver is a preferred metal in such multi-layer transparent conducting stacks, aluminum may also be employed, particularly where the optical design of the multi-layer stack is optimized to maximize overall light transmission. Also, the outermost overcoating metal oxide layer should be at least somewhat, and preferably significantly, conducting so as not to form an electrical insulating overcoat on the metal layer. The sheet resistance for such a metal oxide layer should be less than about 2,000 ohms per square, with less than about 1,000 ohms per square being preferred and less than about 500 ohms per square being more preferred. This overcoating metal oxide layer may be any at least partially conducting, substantially transparent metal oxide such as tin oxide (doped or undoped), indium oxide (doped or undoped), zinc oxide (doped or undoped) and cadmium stannate. The thickness for the overcoating metal oxide layer (as well as the thickness of any undercoating metal oxide layer) is preferably less than about 500 Å, more preferably less than about 300 Å, and most preferably less than about 200 Å.

Such multi-layer transparent conducting stacks are preferably deposited using in-line sputter deposition chambers with either planar or rotary magnetron targets, and with deposition of the metal oxide layers being achieved either by reactive deposition of an oxide coating by sputtering from a metal target (or from a conductive, pressed oxide target) in an oxygen-rich atmosphere, or by radio-frequency ("RF") sputtering from an oxide target. An example of a multi-layer transparent conducting stack is glass/ITO/Ag/ITO, with the thickness of the ITO layers being in the range of about 100 to about 300 Å and the thickness of the silver layer being in the range of about 80 to about 200 Å.

An economical electrochromic rearview mirror may be fabricated by using clear glass as a front substrate, substrate 2, (preferably constructed from float glass) which is coated on its inwardly facing surface with a substantially transmitting, multi-layer transparent conductor comprising at least a thin metal layer overcoated with a transparent conductor metal oxide. For instance, a soda-lime glass substrate coated with indium tin oxide (having a thickness of 150 Å)/silver (having a thickness of 150 Å)/indium tin oxide (having a thickness of 150 Å) may be used for the front substrate, substrate 2. The rear substrate, substrate 3, is coated with a metal reflector (such as silver, aluminum, chromium, titanium, nickel-based alloys like Hastelloy, iron-based alloys like stainless steel, and the like), which also serves as the electrical conductor on substrate 3. An electrochromic medium is disposed between the two con-

fronting inwardly facing conductor surfaces. An example of such a construction is glass/indium tin oxide (having a thickness of 150 Å)/silver (having a thickness of 150 Å)/indium tin oxide (having a thickness of 150 Å)//electrolyte/tungsten oxide (having a thickness of about 6,000 Å)/aluminum (having a thickness of about 2,000 Å)/chromium (having a thickness of about 1,000 Å)/glass, which construction is economical to manufacture as the total thickness of the metal oxide transparent conducting ITO layer is only about 300 Å. This total thickness compares favorably to the use of a half wave or full wave ITO layer with a thickness of about 1,500 Å or 3,000 Å, respectively.

The sheet resistance of the conductive electrode coated glass substrates 2,3 should be less than about 100 ohms per square, with less than about 20 ohms per square being preferred. (However, as described in greater detail hereinafter, for reasons of economy it may sometimes be preferable to use substantially transparent conductive electrodes having a sheet resistance of greater than about 20 ohms per square.) Conductive electrode coated glass substrates are available commercially. For instance, ITO-coated glass substrates made from a glass substrate having deposited thereon a conductive coating of indium oxide that has been doped with tin oxide may be obtained from Donnelly Corporation, Holland, Mich. In addition, tin oxide-coated glass substrates, known as "TEC-Glass" products, may be obtained from Libbey-Owens-Ford Co., LOF Glass Division, Toledo, Ohio.

The "TEC-Glass" products are manufactured by an on-line chemical vapor deposition process. This process pyrolytically deposits onto clear float glass a multi-layer thin film structure, which includes a microscopically thin coating of fluorine-doped tin oxide (having a fine grain uniform structure) with additional undercoating thin film layers disposed between the fluorine-doped tin oxide layer and the underlying glass substrate. This structure inhibits reflected color and increases light transmittance. The resulting "TEC-Glass" product is a non-iridescent glass structure having a haze within the range of from about 0.1% to about 5%; a sheet resistance within the range of from about 10 to about 1,000 ohms per square or greater; a daylight transmission within the range of from about 77% to about 87%; a solar transmission within the range of from about 64% to about 80%; and an infrared reflectance at a wavelength of about 10 μm within the range of from about 30% to about 87%. See e.g., U.S. patent application Ser. No. 08/061,742, filed May 17, 1993, the disclosure of which is hereby incorporated herein by reference.

Examples of the "TEC-Glass" products include "TEC 10" (10 ohms per square sheet resistance), "TEC 12" (12 ohms per square sheet resistance) and "TEC 20" (20 ohms per square sheet resistance) tin oxide-coated glass. More specifically, "TEC 10", for instance, is made from an on-line pyrolytically-coated float glass, onto which has been coated a fluorine-doped tin oxide layer containing as an undercoat an anti-iridescence means. This anti-iridescence means includes a double layer composed of a layer of silica-silicone deposited onto a layer of tin oxide.

The specific resistivity of the conductive electrode coatings 4,4' useful in the present invention may be between about 5×10^{-3} to about 1×10^{-6} ohm.centimeter, depending on the material from which the conductive electrode coatings 4,4' are constructed, and on the method of deposition and formation of the conductive electrode coatings 4,4'. For instance, where the conductive electrode coatings 4,4' are ITO, the specific resistivity is typically within the range of about 1×10^{-4} to about 3×10^{-4} ohm.centimeter. And where

the conductive electrode coatings 4,4' are doped tin oxide, the specific resistivity is typically within the range of about 3×10^{-4} to about 5×10^{-3} ohm-centimeter. Where the conductive electrode coating 4' is a metal, the specific resistivity is typically less than about 5×10^{-3} ohm-centimeter. And where the conductive electrode coating 4' is silver, the specific resistivity is typically less than about 3×10^{-3} ohm-centimeter. The thickness of the metal should be such that the sheet resistance of conductive electrode coating 4' is less than about 0.75 ohms per square, preferably less than about 0.5 ohms per square and more preferably less than about 0.25 ohms per square. Preferably, the thickness of the metal used for conductive electrode coating 4' should be within the range of about 200 Å to about 5,000 Å, with a thickness within the range of 500 Å to about 2,500 Å being preferred and a thickness within the range of about 750 Å to about 1,500 Å being most preferred.

The substantially transparent conductive electrode coating 4 on the inward surface of substrate 2 is preferably highly transmissive in the visible spectrum; that is, with a light transmittance within the range of at least about 60% to greater than about 80%. Likewise, when the conductive electrode coating 4' on the inward surface of substrate 3 is to be highly transmissive, similar high light transmittance is desirable.

The conductive electrode coatings 4,4' should also be highly and uniformly conductive in each direction to provide a substantially uniform response when a potential is applied to the electrochromic element 1. And, the conductive electrode coatings 4,4' should be inert (physically, chemically and electrochemically inert) to the constituents of the electrochromic solid film 7 and the electrolyte 6.

Where the electrochromic solid film 7 is deposited as a coating onto the inward surface of either of conductive electrode coated glass substrates 2,3, it is a barrier coating between whichever of the conductive electrode coatings 4,4' it is deposited on and the electrolyte 6, as well as a barrier coating between the conductive electrode coatings 4,4' themselves.

The electrochromic solid film 7 may be deposited using a variety of film deposition means including, but not limited to, vacuum deposition techniques, such as thermal evaporation, electron beam evaporation, sputter deposition, ion plating, laser-assisted deposition, microwave-assisted deposition and ion-assisted deposition; thermal spraying; pyrolytic deposition; chemical vapor deposition ("CVD"), including atmospheric CVD, plasma enhanced CVD, low pressure CVD and the like; wet chemical deposition, including dip coating, spin coating and spray coating; and thick film methods such as those used in the application of pastes and inks. Suitable deposition results may be obtained with wet chemical deposition as taught by and described in U.S. Pat. No. 4,855,161 (Moser); U.S. Pat. No. 4,959,247 (Moser); U.S. Pat. No. 4,996,083 (Moser); U.S. Pat. No. 5,252,354 (Cronin) and U.S. Pat. No. 5,277,986 (Cronin), the disclosures of each of which are hereby incorporated herein by reference.

It may be beneficial to deposit the electrochromic solid film using vacuum deposition, preferably with an electron beam evaporation technique where the electrochromic solid film 7 is tungsten oxide and is to be placed in direct contact with, or deposited (for example, with an alternate evaporation filament, crucible, boat or an alternate electron beam gun assembly, or the like) as a layer on, the inward surface of substrate 3, which is already coated with a layer of reflective material that serves the dual role as a reflective element and a conductive electrode coating 4'.

The layer of reflective material, which also serves as a conductive electrode coating 4', with or without any adhesion enhancing undercoat layers (discussed hereinafter), may be deposited on the inward surface of substrate 3, with tungsten oxide deposited as an overcoat, without the need to refixture, break vacuum or the like. Thus, it is seen that such a dual purpose reflective element may be deposited with manufacturing ease and economy. This is particularly so when compared with conventional mirror constructions where the reflective element is coated over the rearmost (non-inward) surface of a substrate (which itself is coated with a substantially transparent conductive electrode coating on the opposite, inward surface) in one operation, and thereafter loaded into a vacuum chamber to deposit tungsten oxide onto the other surface of the substrate, which is coated with a substantially transparent conductive electrode.

When vacuum depositing the electrochromic solid film 7 by evaporation or the like, a backfill pressure in a vacuum chamber within the range of about 1×10^{-4} torr to greater than about 5×10^{-4} torr may be used. This backfill pressure may typically be achieved by evacuating the vacuum chamber to some lower base pressure (e.g., less than about 5×10^{-5} torr) and then backfilling the vacuum chamber with a gas such as nitrogen, argon, krypton, oxygen, water vapor and the like, or combinations thereof, to elevate the pressure in the vacuum chamber to a desired backfill pressure. Alternatively, the vacuum chamber may be pumped from atmospheric pressure down to about a pressure within the range of about 1×10^{-4} torr to greater than about 5×10^{-4} torr, and tungsten oxide, for instance, may then be evaporated onto the desired surface of substrates 2,3. It may be desirable during such vacuum deposition to monitor and to control the pressure within the vacuum chamber using pumps, valves and closed loop controls as is known in the vacuum deposition art.

It may be useful to maintain a relatively constant backfill gas pressure during evaporative deposition of the inorganic oxide solid electrochromic film layer, or of other layers such as an adhesion promoter layer and a reflector layer. For example, when evaporating tungsten oxide in the presence of a backfill gas pressure at a desired set backfill pressure, it is usually desirable to first pump the chamber from atmospheric pressure to a base pressure of about 0.1 times the desired backfill pressure. By so doing, the backfill pressure should remain constant during deposition and not be perturbed by outgassing from chamber walls, fixtures and the like.

In order to achieve a relatively constant backfill pressure during deposition without expending extra process and cycle time to pump to 0.1 times the desired backfill pressure, a constant pressure control system, as represented in FIG. 16, may be used. Here, the pressure in vacuum chamber 1600 is monitored by pressure transducer 1601 whose output signal is compared to a pressure set point V_{ps} at the input of differential amplifier/gas controller 1602. The output 1603 of differential amplifier/gas controller 1602 is used to operate variable valve 1604 which will admit gas from gas source 1605 to the vacuum chamber so that the difference between the pressure transducer 1601 output and the pressure set point V_{ps} remains constant. The backfill pressure in the chamber is principally established by gas admittance through fixed valve 1606. The closed-loop operation of variable valve 1604, as described above, serves to decrease the volume of backfill gas admitted when the chamber pressure (as detected by pressure transducer 1601) is determined to rise due to outgassing of water vapor and other gaseous species from the chamber walls, fixtures, evaporant,

etc., and to increase admittance of backfill gas again when chamber pumping decreases the partial pressure of out-gassed species so as to maintain a constant backfill pressure in the chamber during evaporation.

With reference to FIG. 4, the conductive electrode coatings 4,4' in the mirror construction so depicted are substantially transparent. Likewise, in the mirror construction depicted in FIG. 7, conductive electrode coatings 4,4' and substrate 3 are substantially transparent.

With reference to FIG. 5, however, only the conductive electrode coating 4 of the first substrate 2 in the mirror construction so depicted need be substantially transparent; that is, the conductive electrode coating 4' need not be substantially transparent. In addition, the second substrate 3 need not be substantially transparent. In this aspect of the present invention, the layer of reflective material may be coated directly onto the inward surface of the second substrate 3 to serve as the conductive electrode coating 4' as well.

Onto one of conductive electrode coatings 4,4' is deposited a coating of an electrochromic solid film 7, such as an inorganic transition metal oxide, like tungsten oxide. As noted herein, where photochromism may be a concern, the electrochromic solid film 7 should be positioned at the inward surface of substrate 3 (which surface is coated with conductive electrode coating 4'). By so doing, the electrochromic solid film 7 should benefit from the ultraviolet screening and/or absorbing capabilities of the components of the mirror positioned in front of it and closer to incident light.

Silver or aluminum are suitable choices for conductive electrode coating 4' of substrate 3 because either metal may serve as a reflective element for the mirror and metal coatings in general are significantly more conductive than semiconducting oxides, such as ITO or doped tin oxide. As a consequence of using a thin film of metal as conductive electrode coating 4', the substantially transparent conductive electrode coating 4 of substrate 2 may be chosen with an eye toward higher sheet resistance, such as, for example, about 40 to about 100 ohms per square. This is desirable because conductive electrode coatings of higher sheet resistance are typically thinner and less expensive than conductive electrode coatings of lower sheet resistance. ITO or doped tin oxide are suitable choices for substantially transparent conductive electrode coating 4 used in conjunction with a thin film of metal as a reflective element, such as silver or aluminum, that is to serve as conductive electrode coating 4'. In addition, the use of such a thin film of metal as conductive electrode coating 4' permits the conductive strip or clip connectors (known as "bus bars") to be reduced in length, even to a point contact, on conductive electrode coating 4', rather than being used about a substantial portion of the periphery. That is, bus bars 9 may be attached at only a portion of the thin film of metal and still apply an adequate potential across the conductive electrode coatings 4,4'.

Moreover, use of the reflective element of the mirror as the conductive electrode coating 4' is also appealing from a production standpoint. Such use reduces material and manufacturing costs since an additional electrode layer or reflective element need not be provided. In addition, this dual purpose reflective element/conductive electrode coating is environmentally appealing because it is no longer necessary to enhance resistance to degradation, such as environmental degradation, by applying a paint overcoat, which may be lead-based. In addition, such conventional reflective elements located on the rear-most surface of the mirror construction are typically opaque, and, as described hereinafter,

such opacity may result in additional manufacturing effort should an "on demand display" be desirable in a particular mirror construction.

Between the layer of reflective material, typically silver, and the surface of substrate 3 to which it is applied, may desirably be coated a thin film adhesion enhancing means to act as an adhesion promoter ("adhesion promoter"). (See FIG. 6.) The adhesion promoter 11 enhances long-term adhesion of the layer of reflective material to the surface of substrate 3. It is known in the art that there are certain difficulties in adhering a reflective material such as silver to a substrate such as glass, especially where the reflective material is to be deposited by a vacuum deposition process such as evaporation. The adhesion promoter 11 of the present invention overcomes these difficulties and provides a practical way of applying a coating which will function as a dual purpose reflective element/conductive electrode in an electrochromic mirror.

Suitable adhesion promoters 11 include thin films of metal and metal oxides that provide enhanced adhesion over a silver to glass interface, such as chromium, stainless steel, nickel-based alloys (e.g., Hastelloy), titanium, monel, nichrome, molybdenum, metal oxides (e.g., silver oxide, aluminum oxide, indium oxide, indium tin oxide, tin oxide, doped tin oxide, zinc oxide, doped zinc oxide and chromium oxide) and the like. The use of thin films of metal or conducting metal oxides (such as indium tin oxide and doped tin oxides) as adhesion promoters as described herein is advantageous in view of their low cost (due to the relative simplicity of evaporating metal onto a surface of a substrate to form metal or metal oxide coatings), their electrical conductivity that augments that of conductive electrode coating 4', and their mechanical hardness. In addition, use of such thin films of metal or conducting metal oxides as adhesion promoters which undercoat the layer of reflective material assist in maintaining the conductivity of the bus bars 9. This is particularly advantageous in the event a bus bar (e.g., a clip connector) should pierce through the layer of reflective material, because the adhesion promoter is a conductive material that sustains electrical continuity.

An adhesion promoter 11 may be an undercoat of a thin film of a single metal, a metal oxide, or a combination of a metal and a metal oxide. A method for promoting adhesion of the layer of reflective material to a surface of substrate 3 involves deposition, such as by vacuum evaporation or sputtering of a metal, typically silver, initially in an oxygen-rich atmosphere. In this atmosphere, a thin film of silver oxide is applied onto a surface of substrate 3. Then, by progressively decreasing the oxygen atmosphere to zero, a progressively decreased amount of oxide is formed with respect to the metal content in the thin film deposited on the substrate 3. Finally, with little to no oxygen remaining in the atmosphere, a thin film of silver may be built-up upon the previously formed undercoat of its own oxide/gradient oxide to form an adhesion-promoting layer between the surface of substrate 3 and the layer of reflective material. Likewise, chromium may be deposited initially as a thin film of chromium oxide in an atmosphere of enhanced partial pressure of oxygen, followed by deposition of a thin film of metallic chromium by depleting the supply of oxygen. Oxygen may be introduced again to permit the deposition of silver oxide, and finally with deposition of a thin film of metallic silver following in an inert atmosphere. The substrate may also be heated, such as to a temperature within the range of from about 100° C. to about 500° C. (and preferably within the range of from about 150° C. to about 400° C.), during reactive deposition of metal to form a metal oxide.

Heating the substrate in this manner may assist reactive formation of the oxide from the metal and may further enhance adhesion. Moreover, a metal oxide, such as chromium oxide, silver oxide, aluminum oxide, indium oxide, tin oxide, titanium oxide or tantalum oxide, may be deposited, such as reactively deposited in an oxygen-rich atmosphere, by vacuum deposition (e.g., evaporation to sputtering) to form adhesion promoter 11.

The adhesion promoter 11 should have a thickness within the range of from about 10 Å to about 2,500 Å or greater, with about 50 Å to 1,000 Å being preferred.

Adhesion promoter 11 can be a single thin film coating or a stack of thin film coatings. For example, the inward facing surface of substrate 3 can first be coated with a conducting metal oxide adhesion promoter coating of indium tin oxide, which in turn is overcoated with a metal adhesion promoter coating of chromium, with this stack in turn being overcoated with a reflective coating of silver.

In addition to mirrors employing an electrochromic solid film, adhesion promoter 11 of the present invention may also be used in mirrors employing other types of electrochromic technology, such as electrochromic solution technology of the electrochromic type (e.g., Byker I, Byker II, Varaprasad I and Varaprasad III). Thus, adhesion promoter 11 may be used to construct electrochromic mirrors containing an electrochromic solution in which a single coating or stack of coatings functions as a dual purpose reflective element/conductive electrode.

For some applications, it may be desirable to prevent build-up of deposited materials (such as, tungsten oxide and/or silver) at a portion or portions of the inward surface of substrates 2 or 3 inboard from an edge thereof. In this regard, a magnetizable metal mask may be placed over the portion(s) where it is desired to prevent build-up of such deposited materials. The magnetizable metal mask may then be held at that portion of the substrate under a magnetic influence while the material is deposited. For example, a magnetizable metal mask may be placed at the desired location on the inward surface of substrate 3 prior to coating the inward surface thereof with an adhesion promoter (e.g., chromium), a layer of reflective material (e.g., silver) and a layer of an electrochromic solid film (e.g., tungsten oxide). A magnet may be placed on the rearmost surface of substrate 3 behind that location on the inward surface of substrate 3 to ensure that the mask is held in place. Upon removal of the mask after completion of deposition of the chromium/silver/tungsten oxide stack onto the inward surface of substrate 3, a deposition-free portion of that surface is formed.

As stated supra, the spaced-apart glass substrates 2,3 have a sealing means 5 positioned therebetween to assist in defining the interpane spacing in which the electrochromic solid film 7 and the electrolyte 6 are located. The sealing means 5 may be constructed of any material inert (physically, chemically and electrochemically inert) to the electrochromic solid film 7 and the components of the electrolyte 6, as well as to any other material used in the device. To that end, the sealing means 5 may be chosen from the following materials including, but not limited to, various thermosetting materials, such as epoxy resins and silicones, various thermoplastic materials, such as plasticized polyvinyl butyral, polyvinyl chloride, paraffin waxes, ionomer resins, various inorganic materials and the like. For a further recitation of suitable sealing materials, see commonly assigned U.S. Pat. No. 5,233,461 (Dornan).

The thickness of the sealing means 5 may vary from about 10 μm to about 1,000 μm. Preferably, however, this thickness is about 50 μm to about 100 μm.

In addition, the sealing means 5 may prevent escape of the electrolyte 6, when in a liquid-phase, from the electrochromic element 1 or penetration of environmental contaminants into the electrolyte, whether in a liquid-phase or in a solid-phase. Of course, when the electrolyte is in a solid-phase, leakage or seepage of the electrolyte from the mirror is not a concern, but contamination may be.

Desirably, the sealing means 5 comprises a polymer seal formed by the cure of a latent cure adhesive formulation, such as a latent cure epoxy. Such latent cure adhesive formulations, as known in the adhesives arts, comprise an adhesive system (for example, a latent cure epoxy system). A latent cure adhesive system is sometimes referred to as a one-package system since it is supplied in an uncured or only partially cured form in a single package and thus does not require the mixing together of two or more components (such as a resin and a separate hardener as is common with many adhesive systems like two-component epoxy systems). This obviates the need to mix together two or more components when forming the sealing means 5.

Latent cure epoxies typically have a relatively long pot life (e.g., hours to days at room temperature), and so do not appreciably set up and harden at room temperature. However, when exposed to an elevated temperature (which depends on the chosen resin and latent curing agent and typically, for the preferred systems used in this present invention, with the activation temperature being at least about 60° C., and more preferably at least about 90° C.), they cure rapidly to attain their intended cure and bond strength. Thus, latent cure epoxies have a temperature of activation, below which substantial cure is not initiated, but above which relatively rapid cure is achieved. Such systems may be advantageously employed as the seal material in the electrochromic cells of the present invention. Also, latent cure adhesives are particularly amenable to commercial scale manufacture of electrochromic devices such as electrochromic rearview mirrors (whether by silkscreening or by direct dispensing from a needle valve dispenser). These latent cure adhesives have a long pot life so that a batch of adhesive may be used over many hours of production with the assurance that the adhesive will not unduly age due to room temperature cure (which can lead to inconsistency and potential unreliability in the seal so formed). These latent cure adhesives allow for ease and economy of manufacture since by using such one-package, latent cure systems, silkscreens and dispenser systems will not become clogged or obstructed due to room temperature-induced hardening of the seal adhesive system, and the viscosity of the adhesive system remains relatively constant throughout the production day. Clean-up is also facilitated due to a reduction and near elimination of prematurely hardened adhesive on silkscreens or within, for instance, dispenser tubing, needles, and the like.

One-package, latent cure adhesive formulations useful in forming the sealing means 5 may typically include a resin (preferably, an epoxy resin such as EPON Resin 828 commercially available from Shell Chemical Company, Houston, Tex., and a latent curing agent (such as a dicyandiamide, a modified amine, an organic acid anhydride, a macroencapsulated amine, an epoxide adduct encapsulated in a polymerized polyfunctional epoxide, and an adipic dihydrazide). Latent curing agents are commercially available, such as from Air Products and Chemicals Incorporated, Allentown, Penn. under the tradenames ANCAMINE® 2014AS and ANCAMINE® 2014FG. These latent curing agents are modified amines. Other latent curing agents, such as imidazole-based systems, may also be used.

These imidazole-based latent curing agents are also commercially available from Air Products and Chemicals Incorporated under the tradenames IMCURE® (such as, IMCURE® AMI-2) and CUREZOL™ (such as, CUREZOL™ 2B4MZ, 1B2MZ, 2PZ, C17Z, 2MZ, Azinc, 2PHZ-5 and 2MA-OK). Also, latent curing agents are commercially available from AJINOMOTO Incorporated, Teaneck, N.J. under the tradename AJICURE®, examples of which include AJICURE® PN-23 and AJICURE® MY-24. Latent cure adhesives, such as latent cure epoxies, optionally and desirably, include fillers (such as, silica-based fillers like IMSIL A-8, which is commercially available from UNIM Specialty Minerals Incorporated, Elco, Ill., and calcium carbonate-based fillers like SS-14066 HUBERCARB OPTIFILL, which is commercially available from J. M. Huber Corporation, Quincy, Ill., and coupling agents (useful as adhesion promoters) like the silane coupling agents listed in Table I below:

TABLE I

SILANE/COMMERCIAL SUPPLIER	CHEMICAL NAME
Z6020, Dow Corning	N-(2-aminoethyl)-3-amino-propyltrimethoxy silane
Z6092, Dow Corning	N-[2-vinyl benzylamino-ethyl]-3-amino-propyltrimethoxy silane
Z6076, Dow Corning	3-chloropropyltrimethoxy silane
A187, Union Carbide	γ -glycidoxypropyltrimethoxy silane
A1100, Union Carbide	γ -aminopropyltriethoxy silane
A174, Union Carbide	γ -methacryloxypropyltrimethoxy silane
Aldrich Chemicals	2-dichloropropyltrimethoxy silane
Aldrich Chemicals	diphenyldiethoxy silane
Q1-6101, Dow Corning	proprietary organic trimethoxy silane

Coloring agents (such as, carbon black and heavy metal- or iron-based pigments) and spacer beads (such as, glass) may also be included. A particularly useful latent cure adhesive formulation for the commercial production of electrochromic rearview mirrors with good manufacturing economics and with excellent double image performance exhibited by the mated substrates comprises:

Component	Type	Parts Per Hundred	
		Parts of Resin	Type
Resin	EPON 8281	—	Epoxy
Latent Curing Agent	ANCAMINE® 2014FO	28	Modified Amine
Filler	Calcium Carbonate	30	
Coloring Agent	Carbon Black	1	
Spacer Beads	Glass	1	

This latent-cure adhesive formulation may either be silk-screened to form the sealing means 5 or may be applied using an automatic fluid dispensing system, such as a high speed, computer controlled fluid dispensing system supplied by ASYMTEK, Carlsbad, Calif. under the tradename AUTOMOVE 400, and the like. Use of a latent curing agent (which produces long-term stability at room temperature but rapid cure at elevated temperatures) in the adhesive formulation used to establish the sealing means 5 is particularly advantageous when using an automatic fluid dispensing system. In such a system, constancy and control of the fluid viscosity is facilitated, and consistency and precision of the bead of fluid adhesive dispensed around the perimeter of the substrate is also facilitated. Latent curing agents are particularly desirable when precision dispensing valves are used, such as a rotary positive displacement ("RPD") valve like the DV-06 valve commercially available from ASYMTEK.

Once the latent cure adhesive is screened or dispensed around the edge perimeter of a substrate, and after the second substrate is juxtaposed therewith to establish a cell with an interpane spacing, the latent cure adhesive may be rapidly cured by exposure to elevated temperatures, typically greater than about 60° C. Epoxy adhesive systems that use ANCAMINE® latent curing agents and that are cured by exposure to a temperature of at least about 110° C. for a period of time of about one hour, or less, perform excellently. What's more, the cured seal exhibits resilience when exposed to boiling water for a period of time in excess of 96 hours. The double image performance for such ANCAMINE®-cured mirror cells was also found to be superior to comparable two-component epoxy systems in that, during typical production of electrochromic rearview mirrors, double imaging measured from cells using the latent curing agent to effect a cure to form the sealing means 5 was consistently lower than comparably processed electrochromic rearview mirrors which used a two-component epoxy to form the sealing means 5. Also, the glass transition temperature (T_g) for the sealing means 5 formed by cure of a one-package, latent cure adhesive is preferably less than about 140° C., more preferably less than about 120° C. and most preferably less than about 100° C.

One-package adhesive and sealing systems, that are supplied with a latent curing agent already incorporated in the adhesive formulation, are also commercially available. Such one part curing adhesives incorporate an integral hardener or catalyst and typically include a liquid epoxy resin and a diisocyanate hardener. Examples include a one part epoxy adhesive commercially available from AI Technology, Princeton, N.J., under the tradenames EH7580, ME 7150-SMT or ME 7155-ANC; a one part epoxy adhesive commercially available from American Cyanamid, Wayne N.J. under the tradename CYBOND 4802; and a one part epoxy commercially available from CHEMREX, Commerce City, Colo., under the tradename CHEMREX 7459-9772. Also, one part aerobic adhesive and sealing systems, which depend on oxygen or moisture in the air to activate or achieve cure, may also be used to form the sealing means 5. An example of such a one part aerobic adhesive and sealing system is moisture-activated silicone.

Double image performance in rearview mirrors is greatly assisted by the use of a vacuum-assisted sealing technique. An example of such a technique is a vacuum bag technique where, spacer means, such as spacer beads, are disposed across the surfaces of the substrates being mated, and a vacuum is used to better assure substrate to substrate conformity. It is preferable for at least one substrate (usually the first or front substrate) to be thinner than the other, and preferably for at least one substrate to have a thickness of 0.075" or less, with a thickness of 0.063" or less being more preferable, and with a thickness of 0.043" or less being most preferable. This improvement in double image performance is particularly desirable when producing convex or multi-radius outside mirror parts, and when producing large area parts (such as, Class 8 heavy truck mirrors), and especially when vacuum backfilling is used in their production.

Using a vacuum-assisted sealing technique, an uncured sealing adhesive (with spacer beads optionally included therein) may be dispensed around the periphery of a first substrate. Spacer beads, preferably glass beads capable of withstanding a load, are sprinkled across a surface of the second substrate and the first substrate is juxtaposed thereon. This mated assembly is then temporarily affixed (by temporary clamps, a temporary fixture, and the like), and placed within a vacuum bag (such as, a heavy duty "MYLAR" bag).

The bag is then evacuated to a vacuum using a vacuum pump. Atmospheric pressure now evenly bears down on the surfaces of the substrates to be mated forcing conformance of the substrates to each other and to the precision glass spacers that are selected to establish the intended interpane spacing. The temporarily-fixed assembly (still within the vacuum bag) and thus under a pressure of at least 2 lbs./in² is then placed into an oven which is at atmospheric pressure (or into a heated autoclave which may be at several atmospheres pressure) so that the seal adhesive is caused to cure and to set. This may be performed either with vacuum retained by sealing the bag so as to render it airtight or with the hose to the vacuum pump still attached. Once the seal, typically an epoxy, cures and sets, the conformance of the substrates to the spacer beads and to each other is retained by the now-cured adhesive seal, even when the vacuum bag is vented and the fabricated part removed.

For exterior mirrors that have an area of at least about 140 cm², it is desirable to place at least some rigid spacer means (such as precision glass beads) at locations within the interpane space between the substrates in the laminate electrochromic cell. Preferably, such spacer beads are chosen to have a refractive index within the range of about 1.4 to about 1.6 so that they optically match the refractive index of the substrates (typically glass) and the electrolyte. These rigid spacer beads not only assist conformity and uniformity of interpane spacing, but also help maintain the integrity of peripheral seals on exterior rearview mirrors assemblies that use a liquid or thickened liquid. For instance, the peripheral seal may burst if an installer or vehicle owner presses on the mirror at its center and causes a hydraulic pressure build-up at the perimeter seal due to the compression of the fluid or thickened fluid at the part center. Use of such spacer beads, particularly when located at the center of the part within the interpane space, are beneficial in this regard whether the exterior rearview mirror is a flat mirror, convex mirror or multi-radius mirror, and is particularly beneficial when at least the first or front substrate (the substrate touched by the vehicle operator or service installer) is relatively thin glass, such as with a thickness of about 0.075" or less. Use of, for example, two substrates, each having a thickness of about 0.075" or less, for exterior rearview mirrors, including large area mirrors of area greater than about 140 cm², has numerous advantages including reduced weight (reduces vibration and facilitates manually- and electrically-actuated mirror adjustment in the mirror housing), better double-image performance, and more accurate bending for convex/multi-radius parts.

Also, for the sealing means 5, it is advantageous to use a somewhat flexible polymer seal material to reduce double imaging from mated substrates, and to improve hot/cold thermal shock performance for assemblies using a solid electrolyte. For example, the sealing means 5 may be a silicone such as, a one component, black, addition curing silicone polymer system (like those commercially available from Loctite Corporation, Newington, Conn. under the tradename VISLOX V205) or a primerless, one-part, flowable adhesive that develops a strong, self-priming bond to glass (and coated glass) substrates (like those commercially available from Dow Corning, Midland, Mich. under the tradename Q3-6611). Alternatively, a thixotropic, one-part silicone elastomer adhesive, such as X3-6265 commercially available from Dow Corning, may be used to form the sealing means 5. Flexible epoxy resins may also be used to form the sealing means 5.

Standard epoxy resins based on bisphenol A and commonly used curing agents are typically brittle and need to be

modified to give a tough and flexible cured system. Flexibilization of the resin system may be internally (commonly referred to as flexibilizing, which may be achieved through the use of long-chain aliphatic amines as parts of curing agents; the addition of aminated or carboxylated rubbers; the addition of carboxy-terminated polyesters; the addition of long-chain organic compounds containing hydroxyl-functional groups; the use of long-chain aliphatic epoxide materials including epoxidized oils), and externally using plasticizers. Internal flexibilization is preferable, such as is achieved when a typical epoxy resin (for example, with an epoxide equivalent weight of about 185) is flexibilized by addition of a difunctional primary amine curing agent, such as polyoxypropylene diamine commercially available from Texaco Chemical Company, Houston, Tex. under the tradename JEFFAMINE™ 400, and the like. Desirably, about 25-50 parts of any of the above-noted flexibilizers per hundred parts of resin may be used. Such flexibilized epoxy systems have a % elongation at break within the range of about 50 to 150, compared to less than about 10, for rigid epoxies. In addition, urethane adhesive systems, such as FLEXOBOND 431 (which is a clear, two-part urethane system, commercially available from Bacon Industries, Watertown, Mass.) may be used.

Optionally, and desirably when oxygen permeable seal materials such as silicones are used, a double-seal may be used. In this case, a first seal (often, the inner seal when silicone and flexible systems are used) is screened/dispensed and a second seal of a different material (often, a rigid epoxy when the first seal is flexible) is screened/dispensed separately and distinctly from the first seal. Thus, for example, a bead of uncured silicone is screened/dispensed inboard, and around, the perimeter of a substrate, and a bead of uncured epoxy is then dispensed outboard of the silicone bead and around the edge of the substrate. Next, a second substrate is mated with the first substrate so that the double seal adhesive is sandwiched therebetween, and then both adhesive seals are cured in an oven to form the desired cured, double seal.

Also, whether the sealing means 5 is a single seal or a double seal, it may be desirable for the seal material to comprise a cured conductive adhesive so that the seal, or at least a portion thereof, may provide, in whole or at least in part, an electrical bus bar function around the perimeter of a substrate of the assembly. When using such a combined seal and bus bar, care should be taken to avoid electrically shorting the inward facing surfaces of substrates 2 and 3. To obviate this, a seal construction, such as that shown in FIG. 14-A, may be used. With reference to FIG. 14-A, substrates 1420 and 1430 are coated on their inwardly facing surfaces with electrical conductor electrodes 1420' and 1430'. The substrates 1420, 1430 are mated together with the compound seal 1450. The compound seal 1450 includes a conducting seal layer 1450A (formed, for example, of a conducting epoxy such as is described below) and a non-conducting, electrically insulating seal layer 1450B (formed, for example, of a conventional, non-conducting epoxy), which serves to insulate the two conducting electrodes from electrically shorting via conducting seal layer 1450A. Since the compound seal 1450 essentially circumscribes the edge perimeter of the part, the conducting seal layer 1450A (to which electrical potential may be connected to via the electrical lead 1490) serves as an electrically conductive bus bar that distributes applied electrical power more evenly around and across the electrochromic medium (not shown) sandwiched between the substrates 1420 and 1430.

Where the electrical conductor electrode 1420', 1430' on at least one of the opposing surfaces of the substrates 1420,

1430 is removed (or was never coated) in the region of the peripheral edge (as shown in FIG. 14-B), a unitary conducting seal (as opposed to the compound seal of FIG. 14-A) may be used. Reference to FIG. 14-B shows the electrically conducting seal 1450A joining the electrical conductor electrode 1430' on the surface of substrate 1430 to a bare, uncoated surface of opposing substrate 1420. Since the contact area of the conducting seal layer 1450A to the substrate 1420 is devoid of the electrical conductor electrode 1420, the conducting seal layer 1450A does not short the electrodes 1420' and 1430'. Conducting seal layer 1450A serves the dual role of bus bar and seal, yielding economy and ease in device fabrication and production. Conducting seal layer 1450A may form a single seal for the cell or may be one of a double seal formed, for example, when a conventional, non-conducting epoxy is used inboard of that conducting seal.

Such a construction is particularly amenable to devices, such as those depicted in FIGS. 5 and 6. For instance, in a rearview mirror, a fixture can form a mask around the edge substrate perimeter, while an adhesion layer of chromium followed by a reflector layer of aluminum followed by an electrochromic layer of tungsten oxide are deposited. Once removed from such a coating fixture, the edges, as masked by the coating fixture, are uncoated and present a bare glass surface for joining via a conductive epoxy seal to an opposing transparent conductor coated substrate. In such a configuration, the conductive seal can serve as a bus bar for the transparent conductor coated substrate it contacts without shorting to the reflector/adhesion layers on the opposite substrate. Preferably, a fast curing, single component, silver filled, electrically conductive epoxy adhesive is used in such a construction, such as is commercially available from Creative Materials Incorporated, Tyngsboro, Mass., under the tradename CMI 106-32A. Alternatively, 102-05F and 114-11 (also commercially available from Creative Materials Incorporated) electrically conductive inks may be used, which are solvent-resistant, electrically conductive adhesives (with a silver content of greater than about 85%, when cured).

Alternatively, a silver conductor polymer thick film composition, such as the one commercially available from E. I. du Pont de Nemours, Wilmington, Del. under the designation 5025, may be used. Du Pont 5025 is a screen-printable conductive ink that has an air dried sheet resistivity of about 12-15 m Ω /square/mil. Thermoset silver inks may also be used, and are preferred over the air dried variety in terms of conductivity and sealing performance. Such thermoset silver inks are single-component, epoxy based inks, typically with a silver content greater than about 50 with greater than about 75% being preferred, and are fired by exposure to a temperature of about 150° C. for a period of time of about one hour. A suitable thermoset conductive epoxy is 5504N, which is commercially available from Du Pont. Also, electrically conductive adhesives such as AREMCO-BOND 525 (commercially available from Arecco Products, Incorporated, Ossining, N.Y.), may be used. AREMCO-BOND 525 is an electrically conductive adhesive that cures when fired at a temperature of about 350° F. for a period of time of about one hour.

To enhance the integrity of a long-lasting seal in terms of seal resiliency, any electrochromic solid film 7 deposited toward the peripheral edges of one of the substrates 2,3 may be removed so that a seal may be formed directly between a conductive electrode coating 4 of substrate 2 and a conductive electrode coating 4' of substrate 3—i.e., directly between at least a portion of the conductive electrode coated

glass substrates 2,3. This may be accomplished, for example, by depositing tungsten oxide onto larger sheets of glass and then cutting substrates therefrom. By so doing, the tungsten oxide coating extends to the cut edge of the substrate. A variety of removal means may then be employed to remove that portion of the coating from the substrate—up to less than about 2 mm to about 6 mm or thereabouts—inward from the peripheral edges of the substrates. These removal means may include chemical removal, such as with water or with a slightly acidic or basic aqueous solution; physical removal, such as with a blade; laser etching; sandblasting and the like. The conductive electrode coatings 4,4' at the peripheral edge may also be removed in like fashion along with the tungsten oxide overcoat.

Alternatively, substrates 2,3 may be pre-cut to a desired size and shape prior to depositing an electrochromic solid film 7 thereon. These pre-cut substrates may be loaded into a masking fixture to prevent deposition of the electrochromic solid film 7 a pre-determined distance from the edges of the substrates—such as, inward from the edge up to less than about 2 mm to about 6 mm. The masking system may also allow for small tab-out portions to facilitate electrical connections with the conductive electrode coatings 4,4' and the electrochromic solid film 7 deposited in one and the same deposition operation. Of course, it may be possible to employ movable fixturing or to break vacuum and rearrange fixtures should tab-outs not be desired.

Moisture is known to permeate through electrochromic solid films, such as tungsten oxide. Thus, where sealing means 5 is positioned entirely or partially over the electrochromic solid film 7, a secondary weather barrier 12 may be advantageously employed about the periphery of the joint of the assembled laminate (see FIG. 5) to optimize seal integrity which may be compromised by such moisture permeation or permeation of other environmental degradants. Suitable materials for use as a secondary weather barrier 12 include adhesives, such as silicones, epoxies, epoxides and urethanes, which may be ultraviolet curable, room temperature curable or heat curable.

Commercially available adhesives include the cycloalkyl epoxides sold under the "CYRACURE" tradename by Union Carbide Chemicals and Plastics Co., Inc., Danbury, Conn., such as the "CYRACURE" resins UVR-6100 (mixed cycloalkyl epoxides), UVR-6105 (3,4-epoxycyclohexylmethyl-3,4-epoxycyclohexane carboxylate), UVR-6110 (3,4-epoxycyclohexylmethyl-3,4-epoxycyclohexane carboxylate) and UVR-6128 [bis-(3,4-epoxycyclohexyl)adipate], and the "CYRACURE" diluents UVR-6200 (mixed cycloalkyl epoxides) and UVR-6216 (1,2-epoxyhexadecane); those epoxides commercially available from Dow Chemical Co., Midland, Mich., such as D.E.R. 736 epoxy resin (epichlorohydrin-polyglycol reaction product), D.E.R. 755 epoxy resin (diglycidyl ether of bisphenol A-diglycidyl ether of polyglycol) and D.E.R. 732 epoxy resin (epichlorohydrin-polyglycol reaction product), and the NOVOLAC epoxy resins such as D.E.N. 431, D.E.N. 438 and D.E.N. 439 (phenolic epoxides), and those epoxides commercially available from Shell Chemical Co., Oak Brook, Ill., like the "EPON" resins 825 and 1001F (epichlorohydrin-bisphenol A type epoxy resins).

Other commercially available adhesives that are particularly well-suited for use herein as a secondary weather barrier 12 include those epoxides commercially available under the "ENVIBAR" tradename from Union Carbide Chemicals and Plastics Co., Inc., Danbury, Conn., such as "ENVIBAR" UV 1244T (cycloalkyl epoxides).

A secondary weather barrier 12 may be formed around the sealed joint between substrates 2,3 at any point of contact

between the sealing means 5 and the electrochromic solid film 7, using in the case of ultraviolet curable adhesives, commercially available curing systems, such as the Fusion UV Curing Systems F-300 B and F-450 [Fusion UV Curing Systems, Buffalo Grove, Ill.], Hanovia UV Curing System [Hanovia Corp., Newark, N.J.], RC-500 A Pulsed UV Curing System [Xenon Corp., Woburn, Mass.] and a Sunlighter UV chamber fitted with low intensity mercury vapor lamps and a turntable.

A source of an applied potential may be introduced to the electrochromic element 1 of the electrochromic mirror by the electrical leads 10, which may be wire, solder and the like. The electrical leads 10 may typically be connected or affixed to bus bars 9, which themselves may typically be connected or affixed to the conductive electrode coatings 4,4'. The bus bars 9 may be constructed from a variety of conducting materials including metals, alloys, solder such as ultrasonically-applied solder (e.g., Cerasolzer™ manufactured by the Asahi Glass Co., Tokyo, Japan), metal ribbon connectors, conducting polymers (e.g., conducting rubbers and conducting epoxies), conducting frits, such as silver frits [e.g., silver conductive frit #7713 (commercially available from E. I. du Pont de Nemours and Company, Wilmington, Del.)] and the like. A non-exhaustive recitation of such conducting materials may be found in Lynam IV. Bus bar materials such as conducting silver frits or solders may even overlap onto the cut edge of the substrate to facilitate connection of electrical leads in the flush assemblies of the invention.

An exposed portion of the conductive electrode coatings 4,4' may be provided through displacement in opposite directions relative to one another—i.e., laterally from, but parallel to, the cavity which is created by the substrates 2,3 and the sealing means 5—of the substrates 2,3 onto which the bus bars 9 may be affixed or adhered. (See FIG. 11A.) In addition, substrates 2,3 may be off-set to provide an exposed portion of the conductive electrode coatings 4,4' through displacement in opposite directions relative to one another followed by perpendicular displacement relative to one another. (See FIG. 11B.) The dimensions of substrates 2,3 may also be such that, for example, substrate 2 may have a greater width and/or length than substrate 3. Thus, simply by positioning substrates 2,3 in spaced-apart relationship and so that their central portions are aligned will allow for peripheral edges of the substrate with greater dimensions to extend beyond the peripheral edges of the substrate with smaller dimensions. Thus, a portion of conductive electrode coating 4 or 4' will be exposed, depending on whichever of substrates 2,3 is dimensioned with a larger width and/or length. (See FIG. 11C.)

An exposed portion of the conductive electrode coatings 4,4' may also be provided in a flush design, where the substrates 2,3 are sized and shaped to like dimensions. In such a flush design, the first substrate 2 and the second substrate 3 may each be notched at appropriate positions along their respective edges. The notches so provided present convenient areas for bus bars and/or point contacts to which are connected or affixed electrical leads 10 for the introduction of an applied potential thereto.

It may also be desirable to apply a layer of reflective material onto the inward surface of substrate 3, and with substrate 3 notched in at least one appropriate position along its edges. In this way, direct access is available to the conductive electrode coated inward surface of substrate 2. Likewise, substrate 2 may be notched at a position appropriately spaced from the notch or notches on substrate 3 to provide access to the conductive electrode coated inward

surface of substrate 3. These notches provide convenient areas for electrical leads 10 to be connected or affixed, and allow for such connection or affixation to be made within the overall dimensions of the mirror assembly. For example, one or both of the substrates 2,3 may be notched along one or more edges, and bus bars 9 may then be affixed over the exposed portion of conductive electrode coatings 4,4' of substrates 2,3. Electrical leads 10 may then be joined to the bus bars 9. The electrical connection may be made to the inward surfaces of substrates 2,3 without requiring further electrical connection on the peripheral edge of the mirror assembly. As such, the electrical connection to conductive electrode coatings 4,4' will be hidden from view by the reflective element and/or the mirror case or housing.

Alternatively, one or more localized lobe(s) may be provided at appropriate positions along the respective edges of substrates 2,3 to facilitate direct access to the conductive coated inward surfaces of substrates 2,3.

The bus bars 9 may also comprise thin metal films, preferably with a thickness within the range of about 500 Å to about 50,000 Å or greater. These thin metal film bus bars may be deposited onto conductive electrode 4 and/or 4' by vacuum deposition, such as by evaporation or sputtering, and typically have a width within the range of about 0.05 mm to about 6 mm (and preferably with a thickness in the range of 0.05 μm to about 5 μm or greater) and are inboard from the perimeter edge of the substrate.

To form the thin metal film bus bars, a mask may be affixed over the central region of the substantially transparent conductive electrode coated substrate leaving at least a portion, and preferably most, of the perimeter region unmasked. Then a thin film of metal, such as chromium and/or silver, or other metals such as copper, titanium, steel, nickel-based alloys, and the like, may be deposited using a vacuum deposition process across the entire surface, coating both the masked central region and the unmasked peripheral region. Thereafter, the mask may be removed leaving the central region of the substrate transparent and with a conducting thin metal film bus bar deposited on at least a portion of the peripheral region. For manufacturing economy, it may be desirable to establish thin metal film bus bars on the inward surface of substrate 2, conductive electrode coating 4' and electrochromic solid film 7 in a unitary vacuum deposition process step. Thus, it may be convenient to overlay in central alignment, for example, substrate 3 (being uncoated glass) onto the substantially transparent conductive electrode coated surface of substrate 2, where substrate 3 is sized and shaped about 2 mm to about 4 mm smaller in both length and width than substrate 2 (see e.g., FIG. 11C). A peripheral edge of substrate 2 of about 2 mm to about 4 mm will then extend beyond the peripheral edge of substrate 3. In this instance, substrate 2 is made, for example, from ITO-coated glass, and substrate 3 is made from clear soda-lime glass. With this configuration, a vacuum deposition process may be used to deposit a thin metal film and, optionally, a metal oxide thereover, across the entire surface.

Upon completion of the deposition process, the substrates 2,3 may be separated from one another. The formation of a thin metal film bus bar consisting of a chromium/silver coating about the peripheral edge of substrate 2 may then be seen where, because of its smaller dimensions, substrate 3 has served the role of a mask to the major, central region of substrate 2 during deposition. That is, when substrate 3 is removed, the major, central region of substrate 2 has not been coated during the deposition and the transparency of the major, central region of substrate 2 is maintained. Because this thin metal film bus bar is highly conductive and

extends about the entire periphery of substrate 2, electric potential may be supplied by means of a point electrical contact (optionally with local removal of any metal oxide) without the need for a large metal clip or ribbon connector wire as has been conventionally used heretofore. Moreover, because the thin metal film bus bar consists of a chromium/silver coating it forms a highly reflective perimeter coating which may be used to conceal any seal and/or electrical connection for the electrochromic cell. [See U.S. Pat. No. 5,060,112 (Lynam), the disclosure of which is hereby incorporated herein by reference.]

In addition, the surface of substrate 3 which was exposed during deposition is now coated with a chromium/silver/tungsten oxide stack, which may be used as the inward surface in forming an electrochromic cell. The cut edge of substrate 3 is also coated with a chromium/silver coating during the unitary vacuum deposition process due to the inevitable overspray which occurs in such a process. This chromium/silver coating around the cut edge of substrate 3 may itself conveniently be used to establish an electrical connection to apply potential to electrochromic solid film 7.

The applied potential may be supplied from a variety of sources including, but not limited to, any source of alternating current (AC) or direct current (DC) known in the art, provided that, if an AC source is chosen, control elements, such as diodes, should be placed between the source and the conductive electrode coatings 4,4' to ensure that the potential difference between the conductive electrode coatings 4,4' does not change with variations in polarity of the applied potential from the source. Suitable DC sources include storage batteries, solar thermal cells, photovoltaic cells or photoelectrochemical cells.

The applied potential generated from any of these sources may be introduced to the electrochromic element 1 within the range of about 0.001 volts to about 5.0 volts. Typically, however, an applied potential of about 0.2 volts to about 2.0 volts is preferred to cause the electrochromic element to dim to a colored state—i.e., to change the amount of light transmitted therethrough. For electrochromic solid films like tungsten oxide, the negative polarity of the potential should be applied onto whichever of substrates 2,3 the electrochromic solid film 7 is deposited.

Also, in constructions where a metal conductor layer or a metal conductor/reflector layer is contacted with an electrochemically active medium (such as an electrolyte prepared in accordance with this invention or an electrochemichromic solution like those disclosed in, for instance, Byker I and Varaprasad I), it is preferable to apply a cathodic potential (i.e., a negative applied potential) to the metal layer to achieve coloration of the electrochromic device (e.g., an electrochromic rearview mirror). In order to bleach such electrochromic devices, it is preferable to apply a potential of zero volts to the metal conductor layer.

The teaching of the present invention is well-suited for use in electrochromic mirrors whose functional surface is substantially planar or flat. For example, flat electrochromic mirrors for motor vehicles may be manufactured with the electrochromic element of the present invention.

In addition, the present teaching is well-suited for use in electrochromic mirrors having a curved functional surface, with a convex curvature, a compound curvature, a multi-radius curvature, aspherical curvature, an aspheric curvature, or combinations of such curvature. (See FIG. 13.) Convex electrochromic mirrors for motor vehicles may be manufactured with the electrochromic element of the present invention, with radii of curvature typically within the range of about 25" to about 250", preferably within the range of about 35" to about 120", as are conventionally known.

Multi-radius mirrors for motor vehicles, such as those described in U.S. Pat. No. 4,449,786 (McCord), may also be manufactured in accordance with the present invention. Multi-radius mirrors for motor vehicles may typically be used on the driver-side exterior of a motor vehicle to extend the driver's field of view and to enable the driver to see safely and to avoid blind-spots in the rearward field of view. Generally, such mirrors have a region of a higher radius (i.e., substantially planar or flat) closer or inboard to the driver that serves principally as the primary driver's rear vision function and a region of a lower radius (i.e., more curved) farther or outboard from the driver that serves principally as the blind-spot detection zone in the mirror.

In forming spherical mirrors, such as convex exterior mirrors, or aspherical mirrors such as the multi-radius mirror 44 in FIG. 13, the radius of curvature for the substrates to be used for the laminate assembly formed by the electrochromic element 1 between substrates 2,3 should be matched. Moreover, in aspherical mirrors, the two substrates 2,3 in the laminate assembly should be matched so that the local radius in one substrate, for example in the first substrate 2, is located over, and oriented to align with, its corresponding local radius in the other substrate, for example, in the second substrate 3. (See FIG. 13.)

To achieve such radius of curvature matching, a desired shape for the substrates of the aspherical mirrors may be cut from a flat substrate of dimensions greater than that of the desired multi-radius shape. This initial flat substrate ("a flat minilite") may have a rectangular, square or circular shape, or may be of the general shape of the desired multi-radius shape, or any other convenient alternative shape. Glass lites from which the flat minilites may be cut are desirably substantially colorless or tinted soda-lime sheets of glass. In addition, depending on the particular mirror construction and whether the desired bent shape derived from the flat minilite is to be employed as the front substrate 2 or the rear substrate 3, glass lites/flat minilites, from which the desired bent shape may be derived, may be coated with a substantially transparent conductive electrode coating, such as ITO or fluorine-doped tin oxide. As noted supra, fluorine-doped tin oxide coated glass is commercially available from Libbey-Owens-Ford Co. under the "TEC-Glass" tradename.

Once cut, the oversized flat minilites may be bent to the desired multi-radius using either conventional slump bending or press bending. Also, individual minilites may be bent to compound curvature or two flat minilites may be bent together as a matched pair. To manufacture a matched pair of bent minilites, two flat minilites may be stacked on top of one another, loaded in a tandem orientation into a bending press and bent together to the desired curvature (which may be spherical or aspherical in one bending process step).

Where individual bent minilites are to be manufactured, any one bent minilite manufactured in any one bending process step is intended to match any other bent minilite. In electrochromic mirrors, it may be advantageous to use the twin bent minilites manufactured in tandem one on top of the other in the one bending operation step as a given matched pair to assemble a laminate construction.

The desired substrates may be cut from bent minilites to the dimension and shape suitable for use in the intended laminate construction of the particular electrochromic mirror. To the extent that the cullet trimmed away from the bent minilite manufactured as described supra conforms least to the intended radius design, bending oversized minilites is recommended. However, and particularly where the bending operation is to be attentively supervised, the desired dimensioned shape may first be cut from flat glass lites, with the

desired dimensioned shape then bent to the desired multi-radius curvature.

It may be advantageous to cut multi-radius front and rear substrates from their respective bent minillites to facilitate proper alignment of a local radius on the first substrate relative to its corresponding local radius on the second substrate. In this regard, a matched pair of bent minillites may be assembled into a laminate construction with the first substrate laterally displaced from the second substrate, yet sustaining local to local radius alignment there 10 between. In addition, should there be an asymmetry in radius, one perimeter length, LC, of the bent minillite may be identified as the lower radius (more curved part of the minillite compared with its opposite perimeter length, LF, identified as the higher radius (more flat) part of that same bent minillite. Likewise, for its twin match in a matched pair of bent minillites, there may exist corresponding LC and LF perimeter lengths.

Suitable jigs or the like may be used to assemble a laminate construction of an electrochromic mirror with their corresponding perimeter lengths aligned. For example, LC may be aligned a few millimeters (e.g., 3 mm) inboard relative to LC so that their local radii are mutually aligned and the desired electrical connection is established along LC and LF. This may be accomplished by cutting a measured portion (e.g., 3 mm) of bent glass away from along LC and LF and using jigs to align the now-cut edge of LC to the same measured distance (e.g., 3 mm) inboard from LC, with the respective substrates juxtaposed. Because of this alignment, local radius conformity between the substrates in a laminate construction may be established.

Alternatively, the bent minillites may be cut from oversized minillites so that one cut substrate may be laid on top of another cut substrate aligned in substantially flush relationship so that local to local radius conformity may be maintained and electrical connection may be established [See Lynam IV, the disclosure of which is hereby incorporated hereto by reference].

While not required, the minillites may be sufficiently oversized to allow more than one substrate to be cut out from a given minillite, if the bending tool is appropriately designed. By so doing, the substrate cutting process benefits from economies of scale. For example, two substrates may be cut from the one sufficiently oversized bent minillite. These side-by-side matched twin substrates may be used as substrates 2,3 to construct the same electrochromic laminate assembly, or they may be used to serve as a substrate in any electrochromic laminate assembly.

Also, certain substantially transparent conductive electrode coatings, such as doped tin oxides, are aerobically inert, and as such may be bent in an ordinary air atmosphere without taking precautions to exclude oxygen. However, suitable precautions should be taken to avoid any crazing, hazing or optical deterioration of the conductive electrode coatings during the bending process. Other substantially transparent conductive electrode coatings, such as ITO, may be bent from flat sheet stock using techniques such as those described in U.S. Pat. No. 4,490,227 (Bitter), the disclosure of which is hereby incorporated herein by reference. After or during heat treatment of ITO, such as in a bending/annealing process which produces spherical and aspherical shaped substrates suitable for assembling laminate constructions for electrochromic mirrors or when firing ceramic frit bus bar material such as silver conductive frit #7713 (Du Pont), it may be desirable to establish a reducing atmosphere, as described in Bitter, such as a hydrogen-rich atmosphere, like that established with forming gas.

Glass lites and minillites may also be manufactured into spherical and/or aspherical shaped substrates without first being coated with a conductive electrode. In such instances, after the spherical and/or aspherical bent minillites or shaped substrates are manufactured, a conductive electrode coating, such as ITO, may thereafter be deposited onto the concave surface of the substrate 2 and the convex surface of the substrate 3.

A demarcation means 22 may be used in the multi-radius mirrors as described herein to separate the more curved, outboard region 55 (i.e., that portion of an exterior driver-side multi-radius mirror outboard and farthest from the driver) used by the driver principally as the blind-spot detection zone from the less curved, more flat inboard region 65 (i.e., closer to the driver) used by the driver principally for the primary rear vision function. (See FIG. 13.)

The demarcation means 22 may be a black or darkly colored continuous line or closely interspaced dots, dashes or spots (silk-screened or otherwise applied), which divides the outboard region from the inboard region of the multi-radius mirror. This black or darkly colored dividing line (or its aforesaid equivalent) may assist the driver of a motor vehicle to discern the difference between images in the outermost, more curved region from those in the innermost, more flat region of the mirror. The thickness of this dividing line should be within the range of about 0.1 mm to about 3 mm, with about 0.5 mm to about 2 mm being preferred.

The demarcation means 22 may be constructed from an organic material, such as a polymer like an epoxy; an inorganic material, such as a ceramic frit; or a mixed organic/inorganic material. Such demarcation means 22 may be constructed to include, for example, an epoxy coupled with glass spacer beads, or plastic tape or a die cut from plastic tape. The demarcation means may be placed onto the conductive electrode coatings 4,4' of either or both of substrates 2,3 by silk-screening or other suitable technique prior to assembling the device. Also, the demarcation means 22 may be applied—to any or all of the surfaces of substrates 2,3 the inward surfaces of substrates 2,3 or the opposite, non-inward surfaces of substrates 2,3. Additives may be included in the material used as a demarcation means to provide or enhance color, such as a dark color, like black, or dark blue or dark brown; to enhance stability (e.g., ultra-violet stabilizing agents such as described herein); or to increase adhesion (e.g., coupling agents, such as silane-, titanium-, or zirconium-based coupling agents). Alternatively, a dividing line may be established by etching a surface of substrate 2 and/or 3 (such as by sand blasting, laser etching or chemical etching) with optional staining of the etched-surface to develop a dark colored dividing line.

Where ceramic frits are used as a demarcation means and/or where bus bars are formed by applying a silver conductive frit [e.g., #7713 (Du Pont)] around the periphery and inboard from the edge of the inward surface(s) of substrate 2 and/or substrate 3, it may be convenient to silk-screen or otherwise apply the material to either or both of the substrates 2,3 prior to bending. In this way, the bending operation serves the dual purpose of bending and firing/curing the ceramic frit onto the substrates. In addition, where epoxies or other organic-based materials are used as the demarcation means and/or materials which act as bus bars, it may be convenient to silk-screen or otherwise apply the material to either or both of the substrates prior to final cure of the material used as the sealing means so that the sealing means, the demarcation means and/or material which acts as bus bars may be fired/cured in one and the same operation step. A dividing line may also be established within the cavity formed between substrates 2,3.