

(12) **United States Patent**
Tong et al.

(10) **Patent No.:** **US 6,529,741 B1**
(45) **Date of Patent:** ***Mar. 4, 2003**

(54) **MULTI-BIT POWER CONTROL AND POWER CONTROL COMMAND SUB-CHANNEL DESIGN**

(75) Inventors: **Wen Tong**, Ottawa (CA); **Evelyn Le Strat**, Paris (FR)

(73) Assignee: **Nortel Networks Ltd.**, St. Laurent (CA)

(*) Notice: Subject to any disclaimer, the term of this patent is extended or adjusted under 35 U.S.C. 154(b) by 0 days.

This patent is subject to a terminal disclaimer.

(21) Appl. No.: **09/293,540**

(22) Filed: **Apr. 16, 1999**

(51) **Int. Cl.**⁷ **H04Q 7/20**; H04B 7/185

(52) **U.S. Cl.** **455/522**; 455/13.4; 370/318

(58) **Field of Search** 455/68, 69, 70, 455/522, 127, 13.4; 370/342, 318, 320, 468; 375/244, 312, 329, 330, 308

(56) **References Cited**

U.S. PATENT DOCUMENTS

- 5,107,487 A * 4/1992 Vilmur et al. 370/342
- 5,883,899 A * 3/1999 Dahlman et al. 370/468
- 5,982,760 A * 11/1999 Chen 455/522

- 6,034,952 A * 3/2000 Dohi et al. 455/522
- 6,081,727 A * 6/2000 Kondo 455/522
- 6,128,506 A * 10/2000 Knutsson et al. 455/522
- 6,151,508 A * 11/2000 Kim et al. 455/522
- 6,163,707 A * 12/2000 Miller 455/522
- 6,233,439 B1 * 5/2001 Jalali 455/522
- 6,295,289 B1 * 9/2001 Ionescu et al. 455/522
- 6,311,070 B1 * 10/2001 Tong et al. 455/522

* cited by examiner

Primary Examiner—Tracy Legree

(74) *Attorney, Agent, or Firm*—Bruce Garlick

(57) **ABSTRACT**

The invention provides a system and method for controlling transmission power of a mobile unit in a wireless communication system which minimizes transmission power overshoot caused by counteracting the effects of deep fading. Sets of power control bits are transmitted from the base station to the mobile unit using $\pi/4$ DQPSK modulation. A first set of the bits indicates to the mobile unit a request to increase the mobile units transmission power by a predetermined amount. A second set of the bits indicates to the mobile unit that the mobile unit should increase its transmission power by an amount which is greater than the predetermined amount. A third set of the bits indicates to the mobile unit a request to decrease the mobile units transmission power by the predetermined amount. A fourth set of the bits indicates to the mobile unit that the mobile unit should decrease its transmission power by the amount which is greater than the predetermined amount.

23 Claims, 4 Drawing Sheets

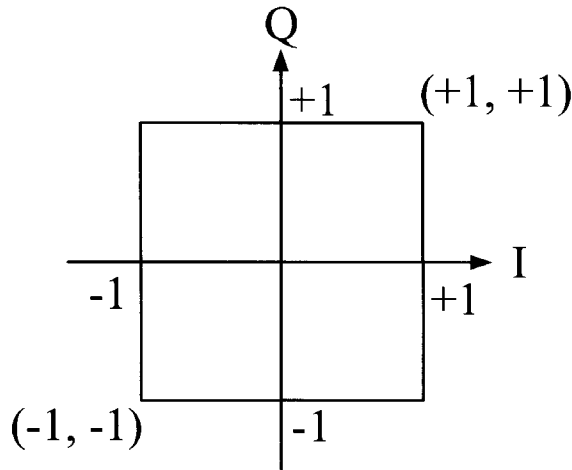
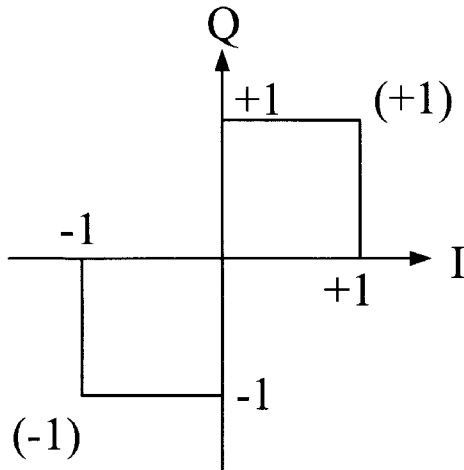

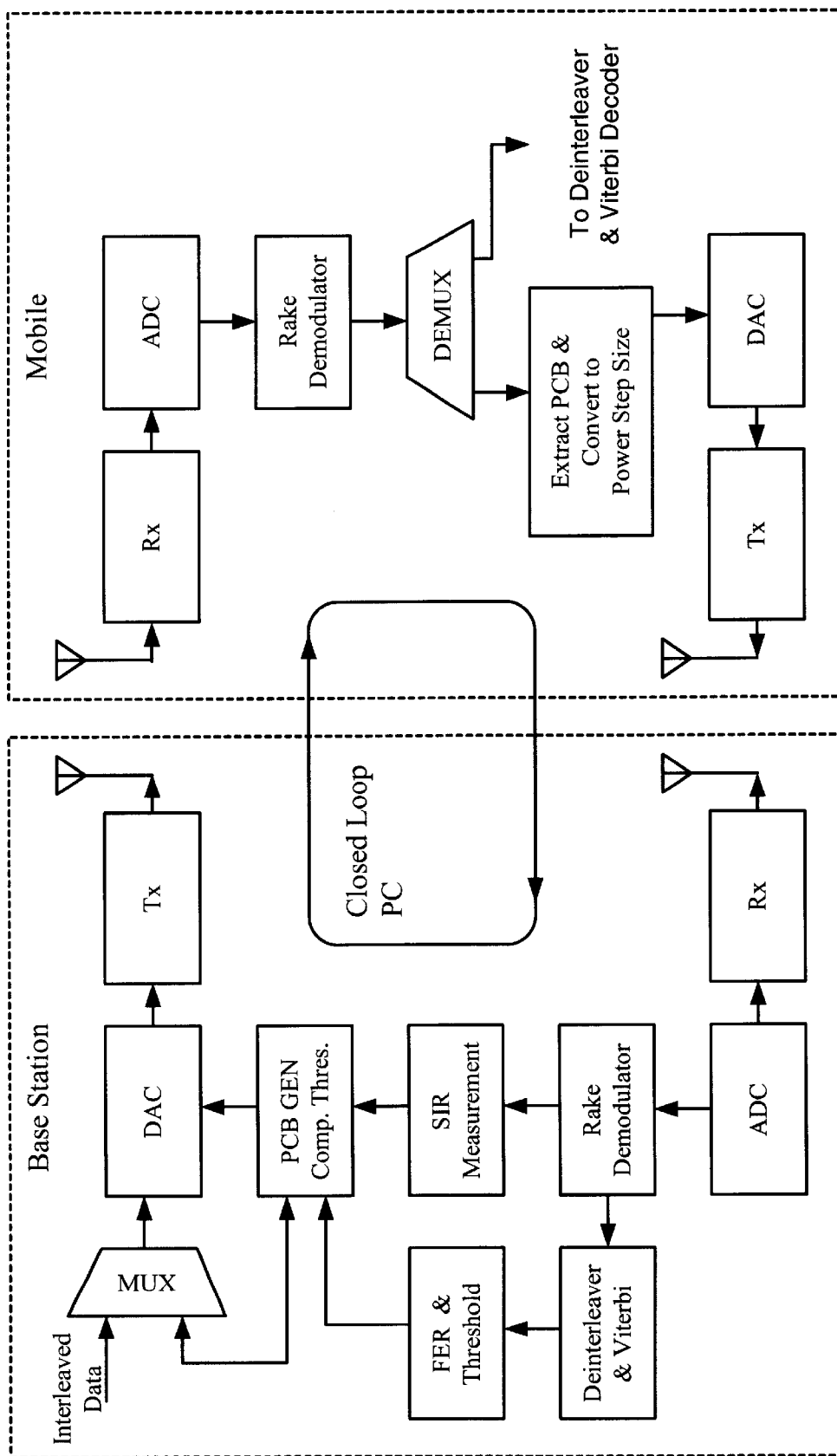
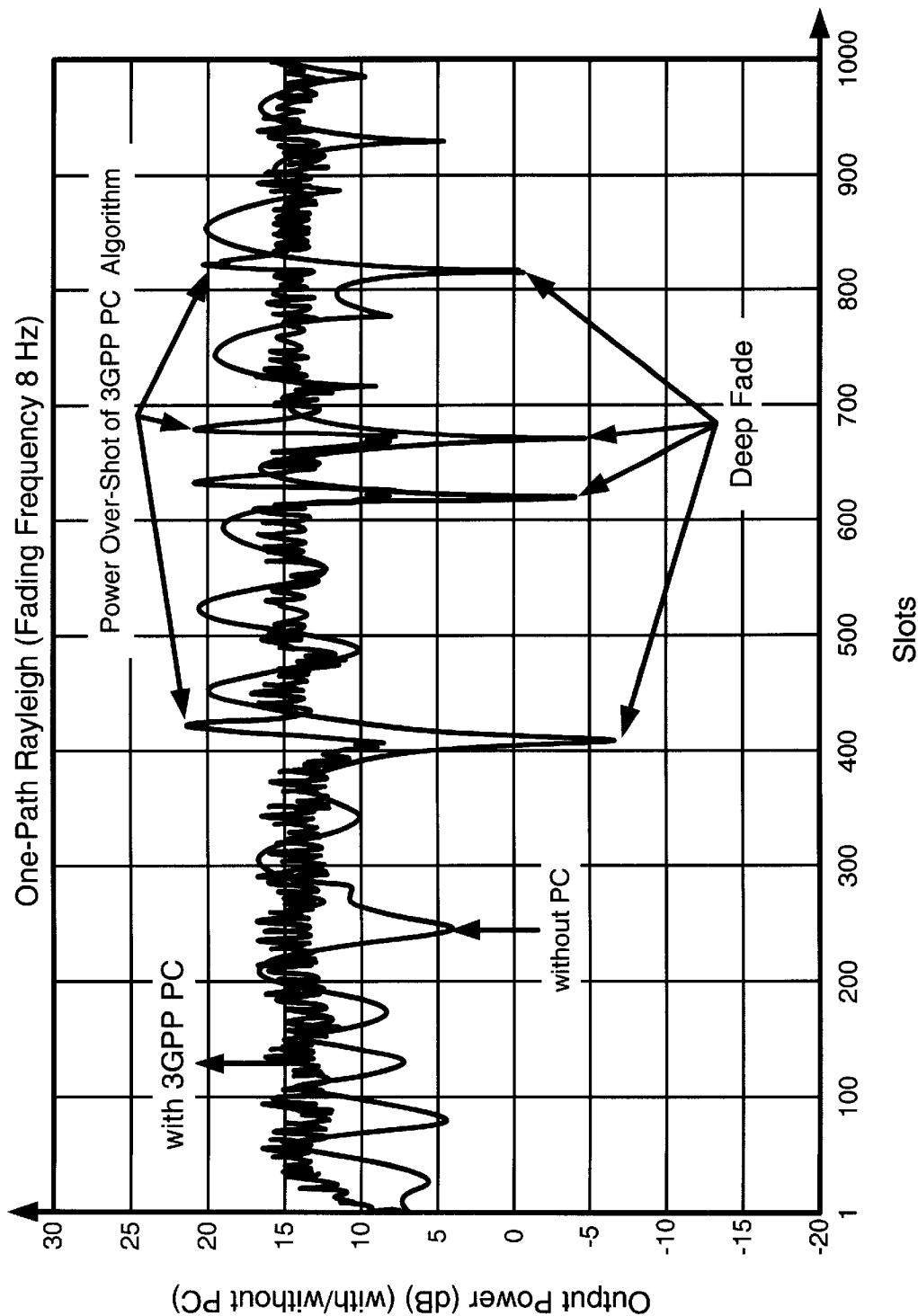

FIG. 1 (PRIOR ART)

Figure 2. 3GPP Closed Loop Power Control Algorithm



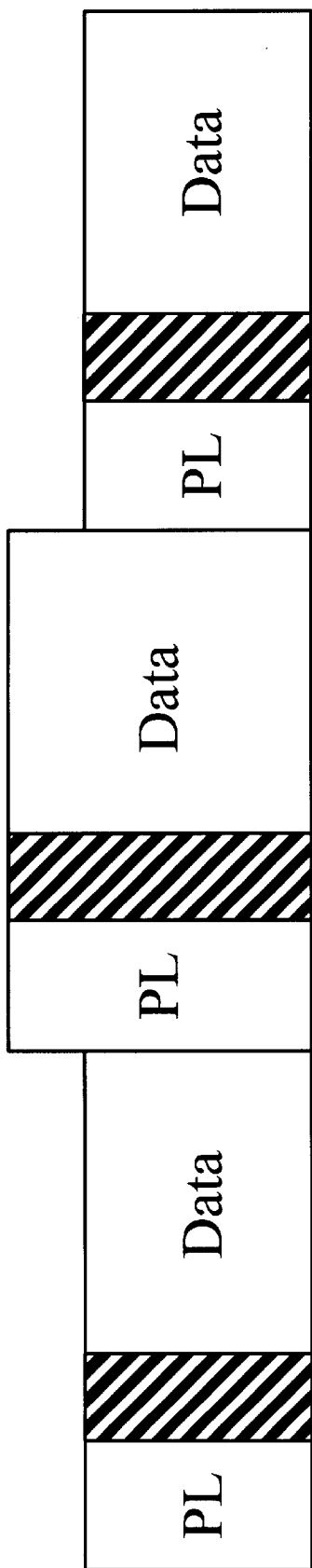

FIG. 3a
(Prior Art)

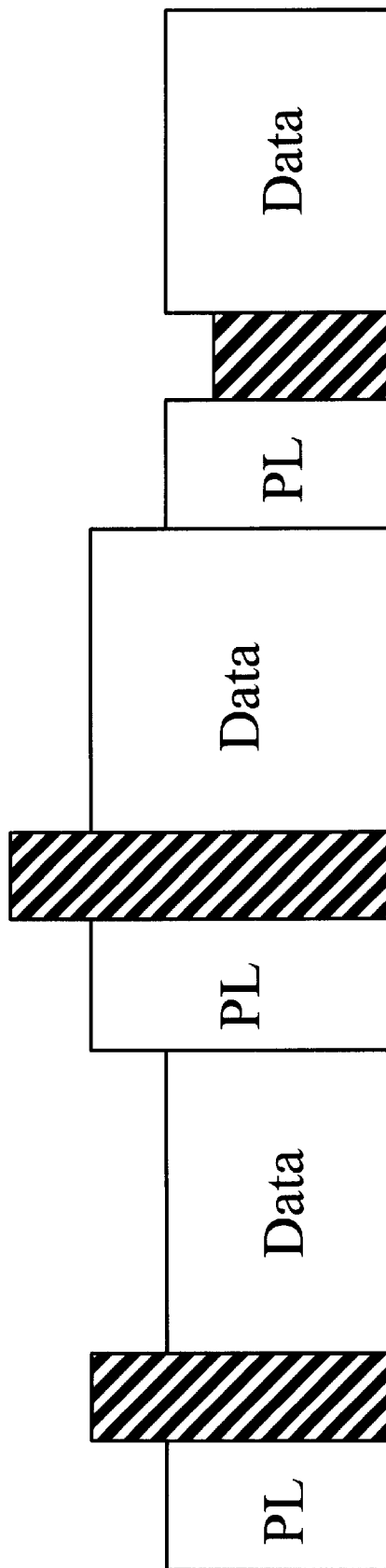

FIG. 3b
(Prior Art)

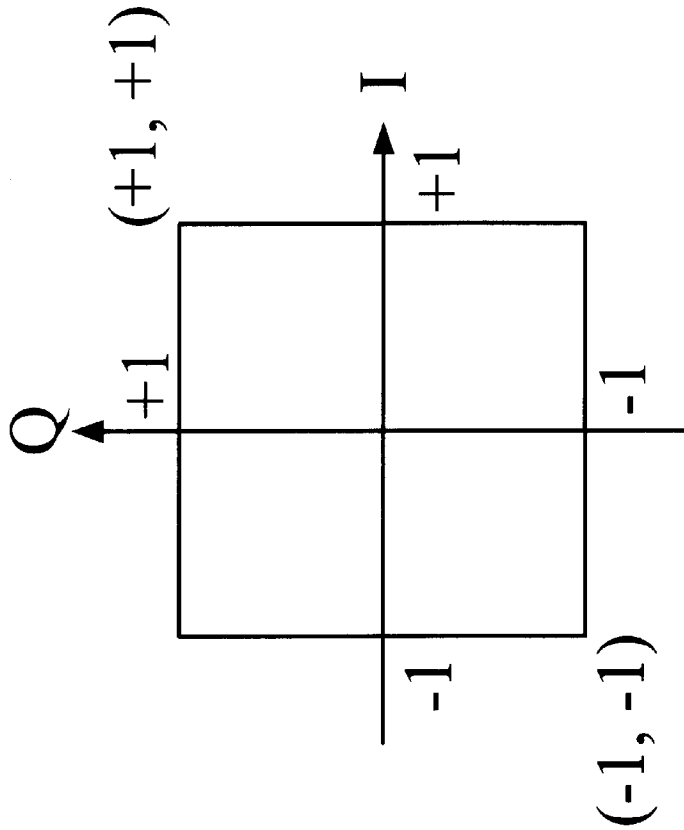

FIG 4b

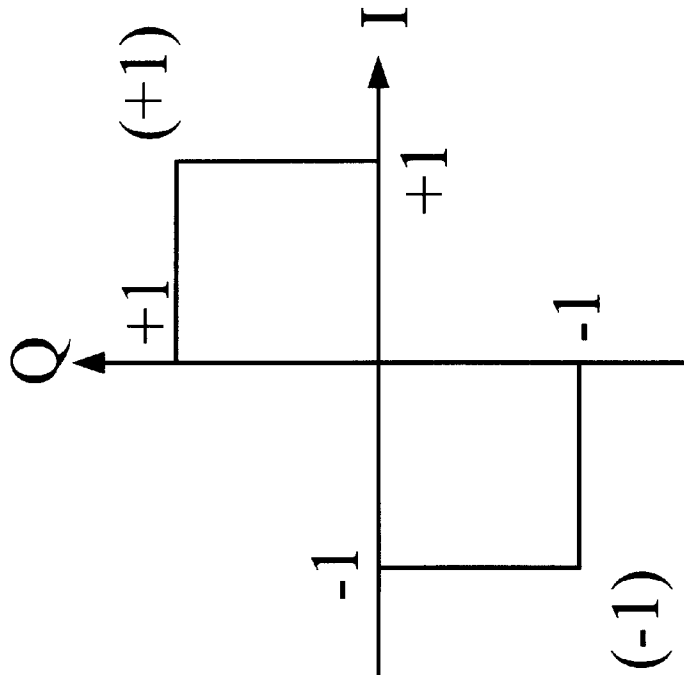

FIG 4a

Explore Litigation Insights

Docket Alarm provides insights to develop a more informed litigation strategy and the peace of mind of knowing you're on top of things.

Real-Time Litigation Alerts



Keep your litigation team up-to-date with **real-time alerts** and advanced team management tools built for the enterprise, all while greatly reducing PACER spend.

Our comprehensive service means we can handle Federal, State, and Administrative courts across the country.

Advanced Docket Research



With over 230 million records, Docket Alarm's cloud-native docket research platform finds what other services can't. Coverage includes Federal, State, plus PTAB, TTAB, ITC and NLRB decisions, all in one place.

Identify arguments that have been successful in the past with full text, pinpoint searching. Link to case law cited within any court document via Fastcase.

Analytics At Your Fingertips



Learn what happened the last time a particular judge, opposing counsel or company faced cases similar to yours.

Advanced out-of-the-box PTAB and TTAB analytics are always at your fingertips.

API

Docket Alarm offers a powerful API (application programming interface) to developers that want to integrate case filings into their apps.

LAW FIRMS

Build custom dashboards for your attorneys and clients with live data direct from the court.

Automate many repetitive legal tasks like conflict checks, document management, and marketing.

FINANCIAL INSTITUTIONS

Litigation and bankruptcy checks for companies and debtors.

E-DISCOVERY AND LEGAL VENDORS

Sync your system to PACER to automate legal marketing.