



(19) **United States**

(12) **Patent Application Publication**  
Madaus et al.

(10) **Pub. No.: US 2004/0025882 A1**

(43) **Pub. Date: Feb. 12, 2004**

(54) **HOLDING DEVICE FOR A RESPIRATORY MASK**

**Publication Classification**

(76) Inventors: **Stefan Madaus, Krailling (DE); Harald Voge, Gauting (DE)**

(51) **Int. Cl.<sup>7</sup> ..... A62B 18/08; A62B 9/06**  
(52) **U.S. Cl. .... 128/206.27; 128/207.11; 128/207.17**

Correspondence Address:  
**PILLSBURY WINTHROP, LLP**  
**P.O. BOX 10500**  
**MCLEAN, VA 22102 (US)**

(57) **ABSTRACT**

(21) Appl. No.: **10/333,020**

(22) PCT Filed: **Jun. 22, 2001**

(86) PCT No.: **PCT/EP01/07132**

(30) **Foreign Application Priority Data**

Jul. 21, 2000 (DE)..... 100 35 946.9

A holding device for a respiratory mask, especially for use in the field of sleep medicine, includes a headband which, in an application position, extends from the forehead area of the patient to behind the ear area of the patient, whereby the headband is provided with a flexible reinforcing insert for reinforcing the headband in a lateral direction. This makes it advantageously possible to provide the mask retention forces, which are necessary for reliably applying a respiratory mask, in a manner that is very compatible with regard to ergonomics.

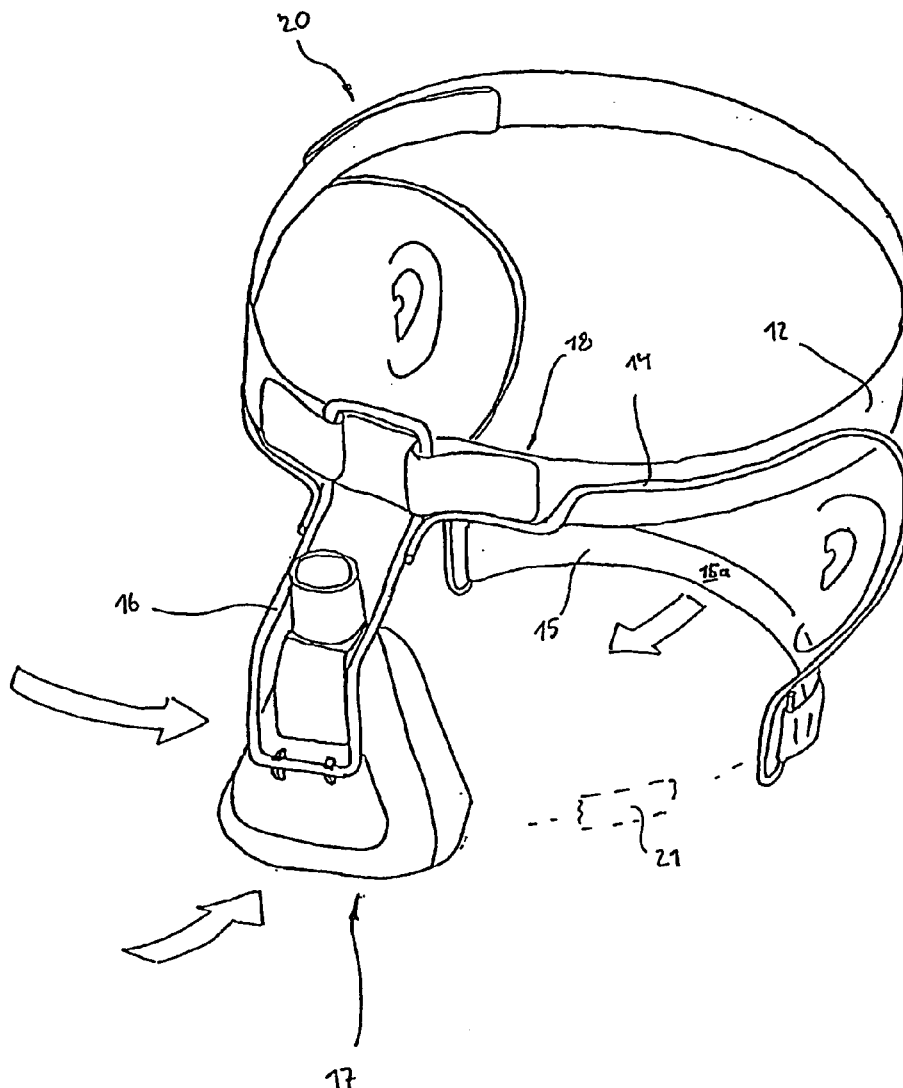

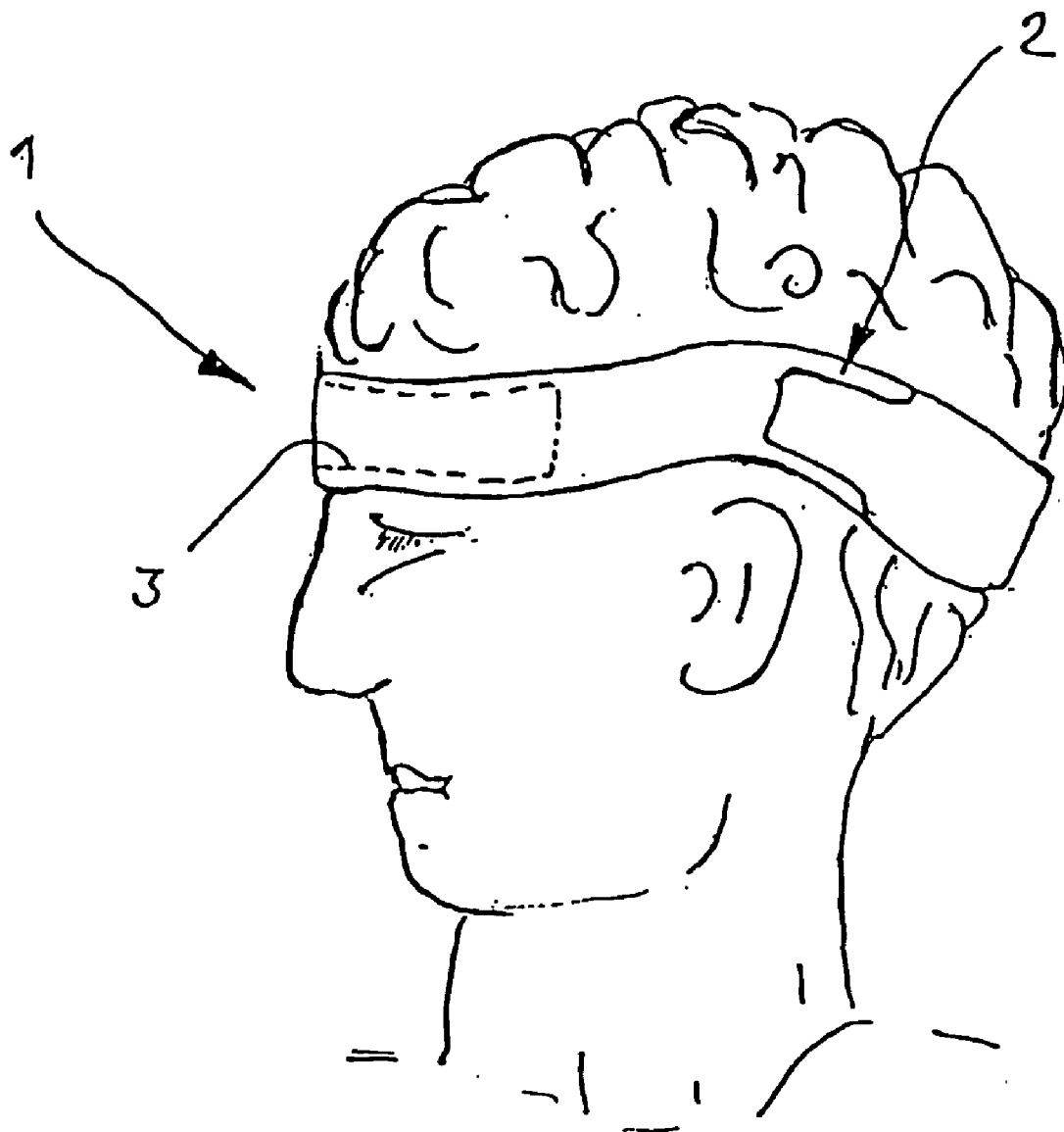

Fig. 1

Fig. 2

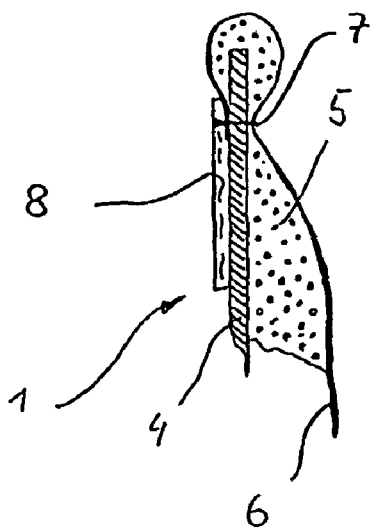

Fig. 3

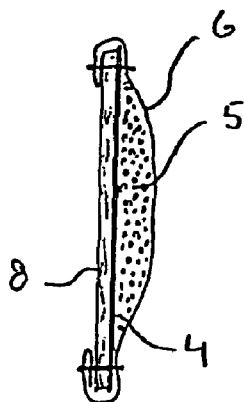

Fig. 4

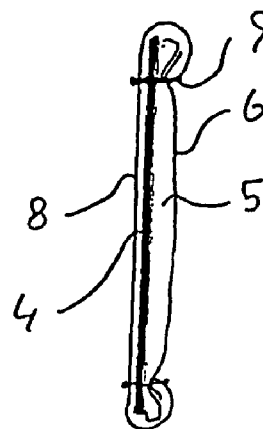

Fig. 5

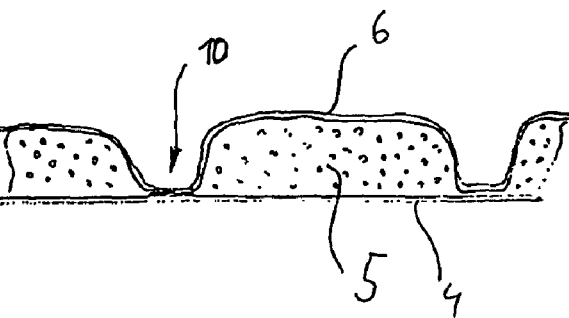
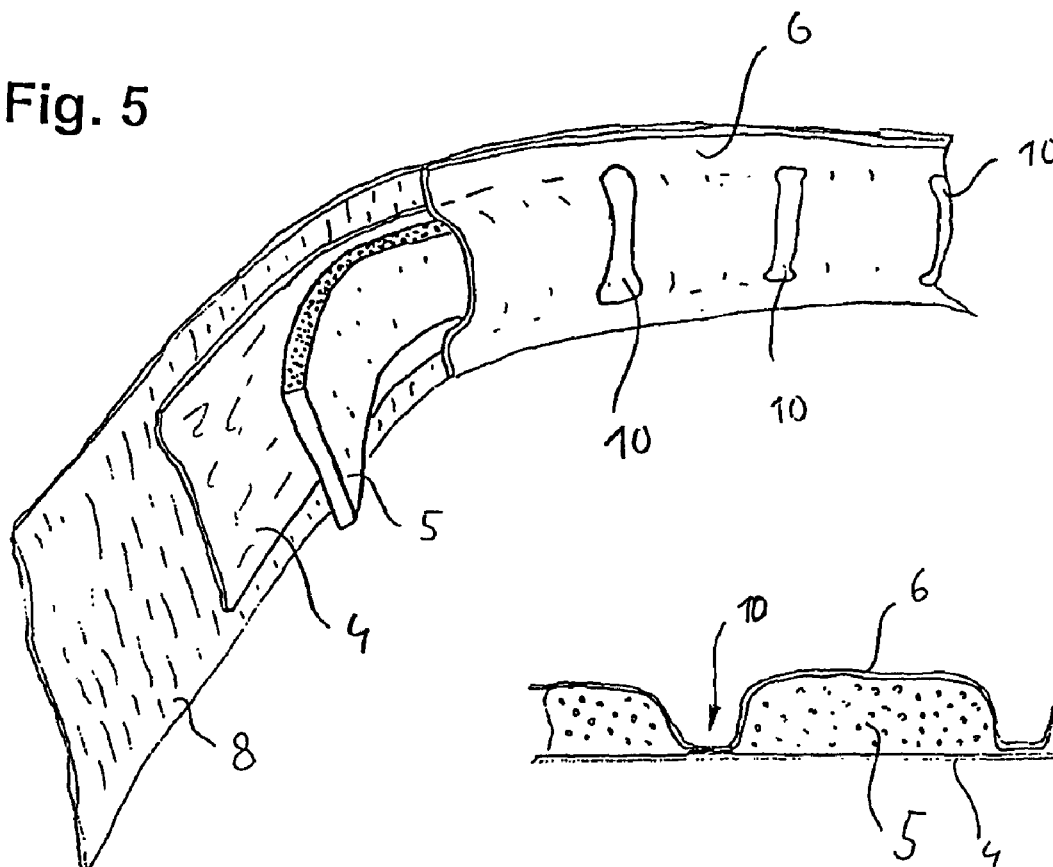

Fig. 6

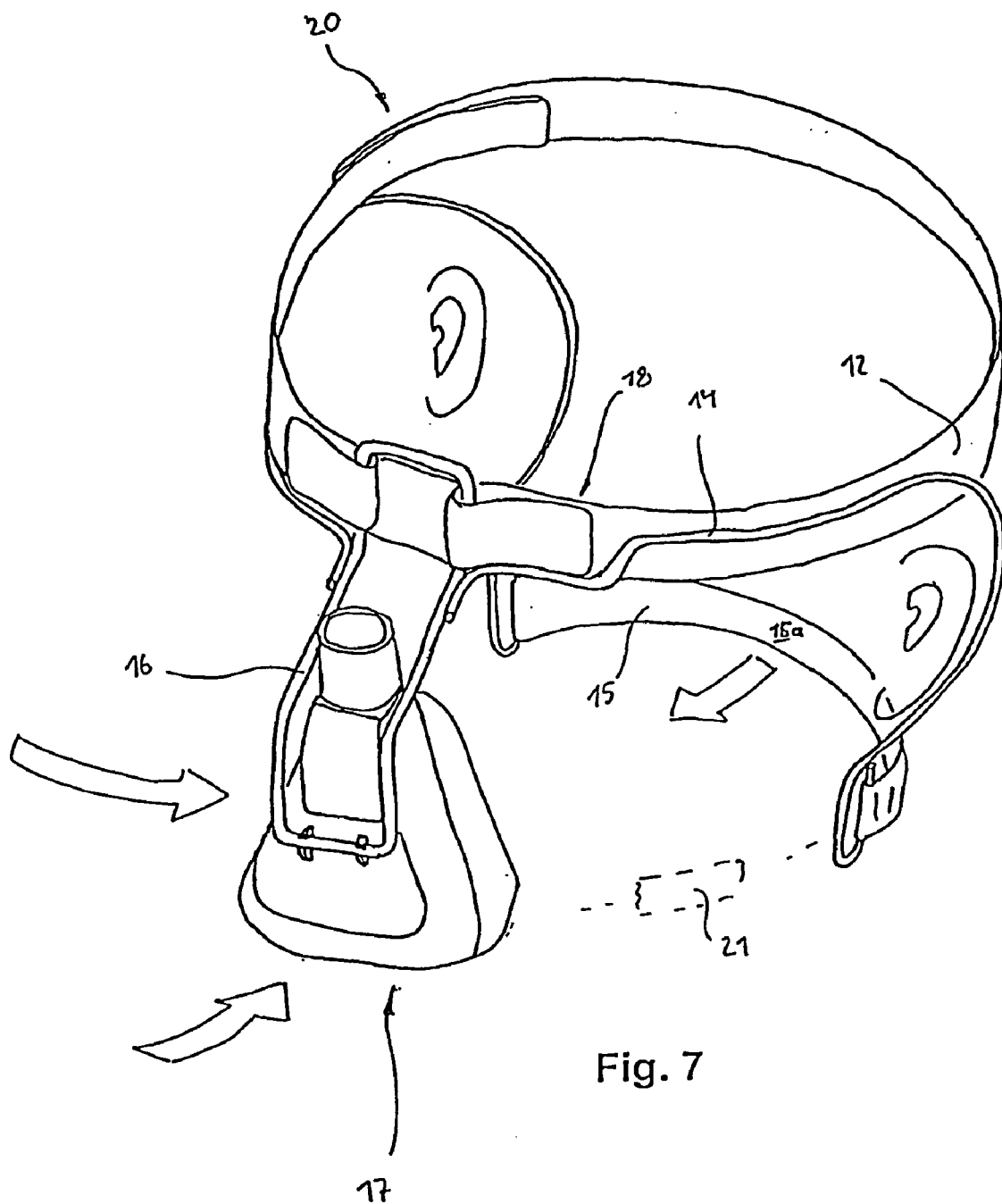

Fig. 7

Fig. 8

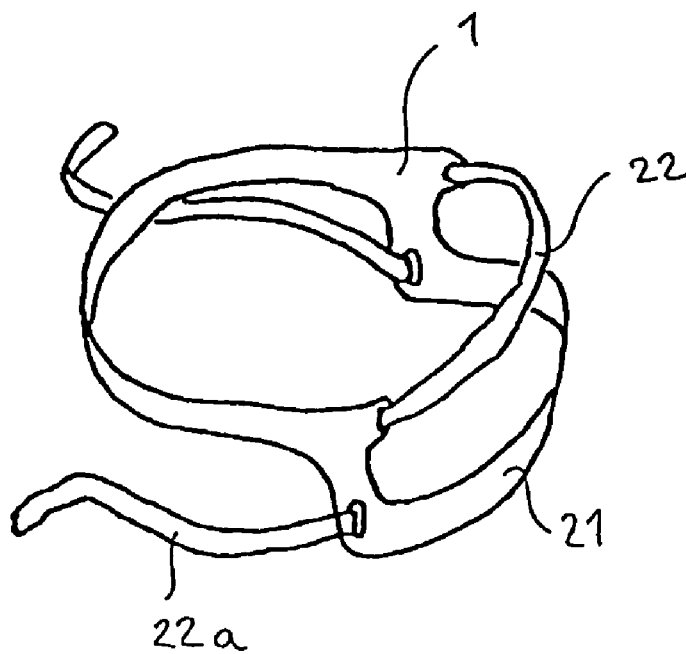
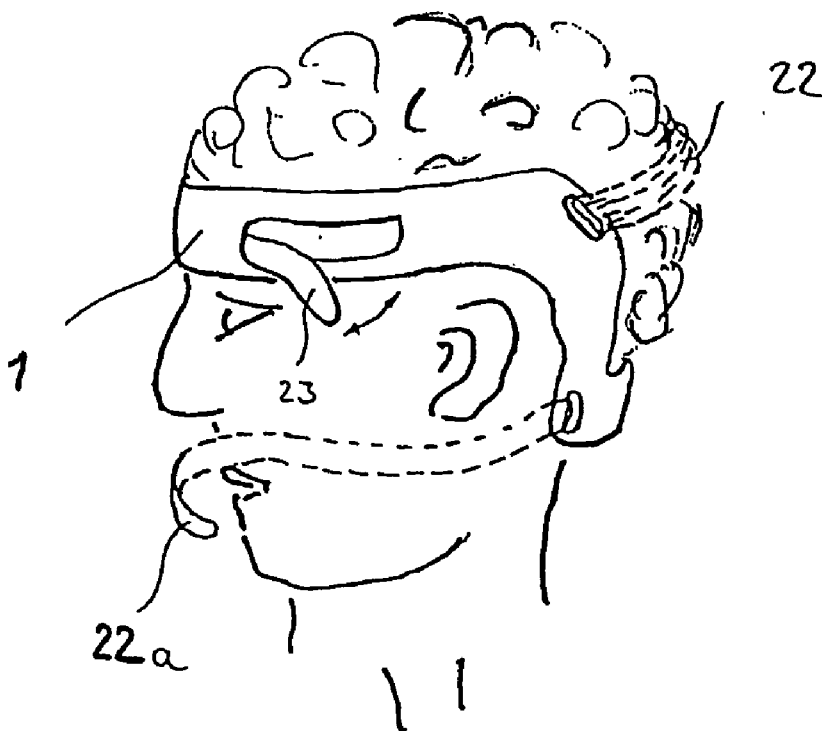

Fig. 9



# Explore Litigation Insights

Docket Alarm provides insights to develop a more informed litigation strategy and the peace of mind of knowing you're on top of things.

## Real-Time Litigation Alerts



Keep your litigation team up-to-date with **real-time alerts** and advanced team management tools built for the enterprise, all while greatly reducing PACER spend.

Our comprehensive service means we can handle Federal, State, and Administrative courts across the country.

## Advanced Docket Research



With over 230 million records, Docket Alarm's cloud-native docket research platform finds what other services can't. Coverage includes Federal, State, plus PTAB, TTAB, ITC and NLRB decisions, all in one place.

Identify arguments that have been successful in the past with full text, pinpoint searching. Link to case law cited within any court document via Fastcase.

## Analytics At Your Fingertips



Learn what happened the last time a particular judge, opposing counsel or company faced cases similar to yours.

Advanced out-of-the-box PTAB and TTAB analytics are always at your fingertips.

## API

Docket Alarm offers a powerful API (application programming interface) to developers that want to integrate case filings into their apps.

## LAW FIRMS

Build custom dashboards for your attorneys and clients with live data direct from the court.

Automate many repetitive legal tasks like conflict checks, document management, and marketing.

## FINANCIAL INSTITUTIONS

Litigation and bankruptcy checks for companies and debtors.

## E-DISCOVERY AND LEGAL VENDORS

Sync your system to PACER to automate legal marketing.