

Exhibit 27 – Infringement Claim Chart for U.S. Patent No. 7,490,749

U.S. 7,490,749 – Claim 1	SureForm Stapler and Reloads ¹
I. A surgical instrument, comprising:	<p>The SureForm 60 with a SureForm 60 Reload installed is a surgical instrument for stapling and transecting tissue.</p> <div data-bbox="509 768 1398 913" style="border: 1px solid black; padding: 5px;"> <p>1.7 Device Description</p> <p>The SureForm 60, when used with the compatible SureForm 60 reloads, delivers multiple rows of staples and transects the tissue along the middle of the staple line. The SureForm 60 and the SureForm 60 reloads (available in various sizes) are single-use/disposable devices.</p> </div> <p style="text-align: center;">Exhibit 29 at p. 9</p>
a handle assembly;	<p>The SureForm 60 comprises a handle assembly:</p> <div data-bbox="664 1031 1240 1377" style="border: 1px solid black; padding: 5px;"> <p style="text-align: center;">Figure 1.2 Stapler (reload installed)</p> </div> <p style="text-align: center;">Exhibit 29 at p. 11 (annotations in red)</p>

¹ The SureForm Stapler and Reloads includes (1) SureForm 60 Stapler for use with the *da Vinci X/Xi Surgical System*; (2) SureForm 60 Reloads (white, blue, green, black); (3) SureForm 45 Stapler for use with the *da Vinci X/Xi Surgical System*; and (4) SureForm 45 Reloads (white, blue, green, black).

1. Straighten the wrist for optimal guided tool change behavior and ease of removal. See Stapler Guided Tool Change on page 26 for more information.
2. Squeeze the release buttons on the housing and carefully withdraw the stapler as shown in Figure 2.18.

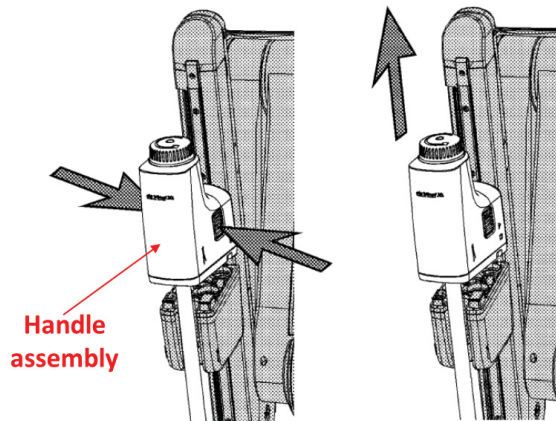
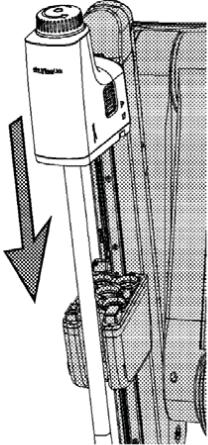

Figure 2.18 Instrument removal

Exhibit 29 at p. 24 (annotations in color)

U.S. 7,490,749 – Claim 1	SureForm Stapler and Reloads ¹
	<p>Always use two hands when installing the stapler; one hand holding the jaws closed and the other supporting the housing of the stapler. Insert the instrument tip into the cannula and slide the instrument housing into the sterile adapter.</p>  <p>Figure 2.6 Inserting the instrument into the cannula and sterile adapter Exhibit 29 at p. 17 (annotations in yellow)</p>
<p>an end effector for performing a surgical operation, said end effector operably coupled to said handle assembly and operably supporting a firing member that is movable from a retracted position to a fired position</p>	<p>The SureForm 60 with a SureForm 60 Reload comprises an end effector for performing a surgical operation—stapling and cutting tissue. The end effector is operably coupled to said handle assembly (<i>i.e.</i>, housing) via the shaft and operably supports a firing member (<i>i.e.</i>, I-beam) that is movable from a retracted position to a fired position in response to a longitudinal firing motion applied thereto. The end effector of the SureForm 60 includes two jaws: a Reload Channel and an Anvil.</p>

U.S. 7,490,749 – Claim 1

SureForm Stapler and Reloads¹

in response to a longitudinal firing motion applied thereto;

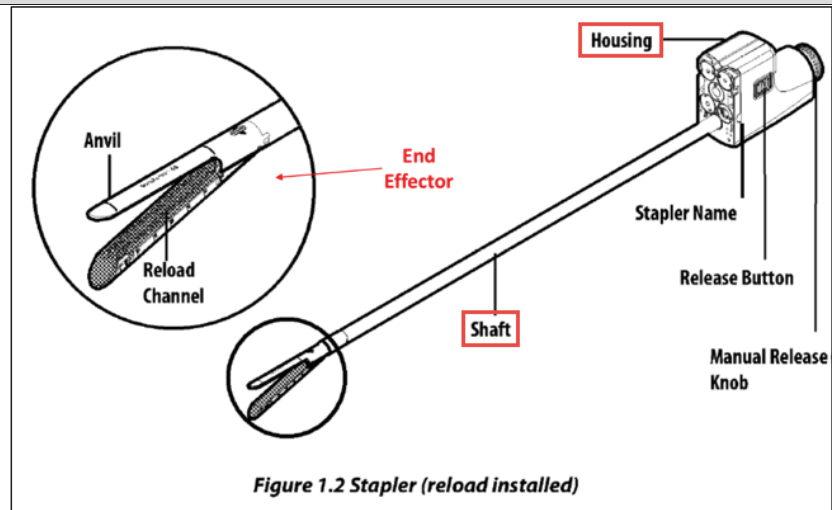

Figure 1.2 Stapler (reload installed)
Exhibit 29 at p. 11 (annotations in red)

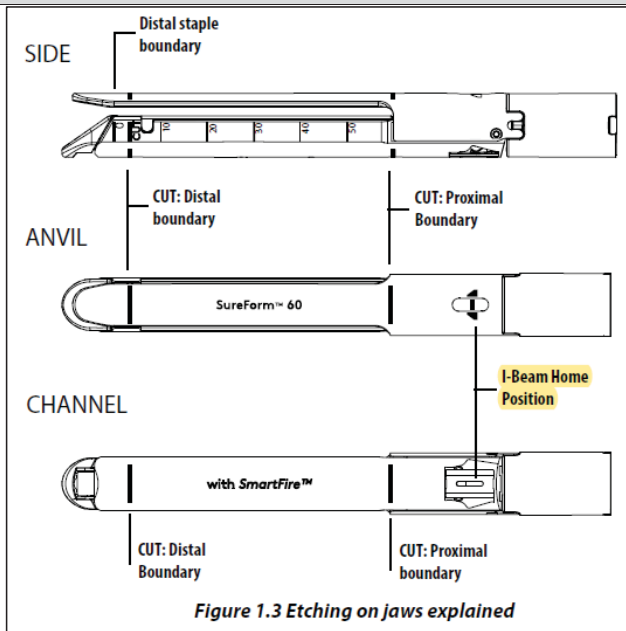

Figure 1.3 Etching on jaws explained

Exhibit 29 at p. 11 (annotation in yellow)

Explore Litigation Insights

Docket Alarm provides insights to develop a more informed litigation strategy and the peace of mind of knowing you're on top of things.

Real-Time Litigation Alerts



Keep your litigation team up-to-date with **real-time alerts** and advanced team management tools built for the enterprise, all while greatly reducing PACER spend.

Our comprehensive service means we can handle Federal, State, and Administrative courts across the country.

Advanced Docket Research



With over 230 million records, Docket Alarm's cloud-native docket research platform finds what other services can't. Coverage includes Federal, State, plus PTAB, TTAB, ITC and NLRB decisions, all in one place.

Identify arguments that have been successful in the past with full text, pinpoint searching. Link to case law cited within any court document via Fastcase.

Analytics At Your Fingertips



Learn what happened the last time a particular judge, opposing counsel or company faced cases similar to yours.

Advanced out-of-the-box PTAB and TTAB analytics are always at your fingertips.

API

Docket Alarm offers a powerful API (application programming interface) to developers that want to integrate case filings into their apps.

LAW FIRMS

Build custom dashboards for your attorneys and clients with live data direct from the court.

Automate many repetitive legal tasks like conflict checks, document management, and marketing.

FINANCIAL INSTITUTIONS

Litigation and bankruptcy checks for companies and debtors.

E-DISCOVERY AND LEGAL VENDORS

Sync your system to PACER to automate legal marketing.