

United States Patent [19]

[11] 3,971,065

Bayer

[45] July 20, 1976

[54] COLOR IMAGING ARRAY

[75] Inventor: Bryce E. Bayer, Rochester, N.Y.

[73] Assignee: Eastman Kodak Company,
Rochester, N.Y.

[22] Filed: Mar. 5, 1975

[21] Appl. No.: 555,477

[52] U.S. Cl. 358/41; 350/162 SF;
350/317; 358/44[51] Int. Cl.² H04N 9/24[58] Field of Search 358/44, 45, 46, 47,
358/48; 350/317, 162 SF; 315/169 TV

[56] References Cited

UNITED STATES PATENTS

2,446,791	8/1948	Schroeder	358/44
2,508,267	5/1950	Kasperowicz	358/44
2,884,483	4/1959	Ehrenhaft et al.	358/44
3,725,572	4/1973	Kurokawa et al.	358/46

Primary Examiner—George H. Libman

Attorney, Agent, or Firm—George E. Grosser

[57]

ABSTRACT

A sensing array for color imaging includes individual luminance- and chrominance-sensitive elements that are so intermixed that each type of element (i.e., according to sensitivity characteristics) occurs in a repeated pattern with luminance elements dominating the array. Preferably, luminance elements occur at every other element position to provide a relatively high frequency sampling pattern which is uniform in two perpendicular directions (e.g., horizontal and vertical). The chrominance patterns are interlaid therewith and fill the remaining element positions to provide relatively lower frequencies of sampling.

In a presently preferred implementation, a mosaic of selectively transmissive filters is superposed in registration with a solid state imaging array having a broad range of light sensitivity, the distribution of filter types in the mosaic being in accordance with the above-described patterns.

11 Claims, 10 Drawing Figures

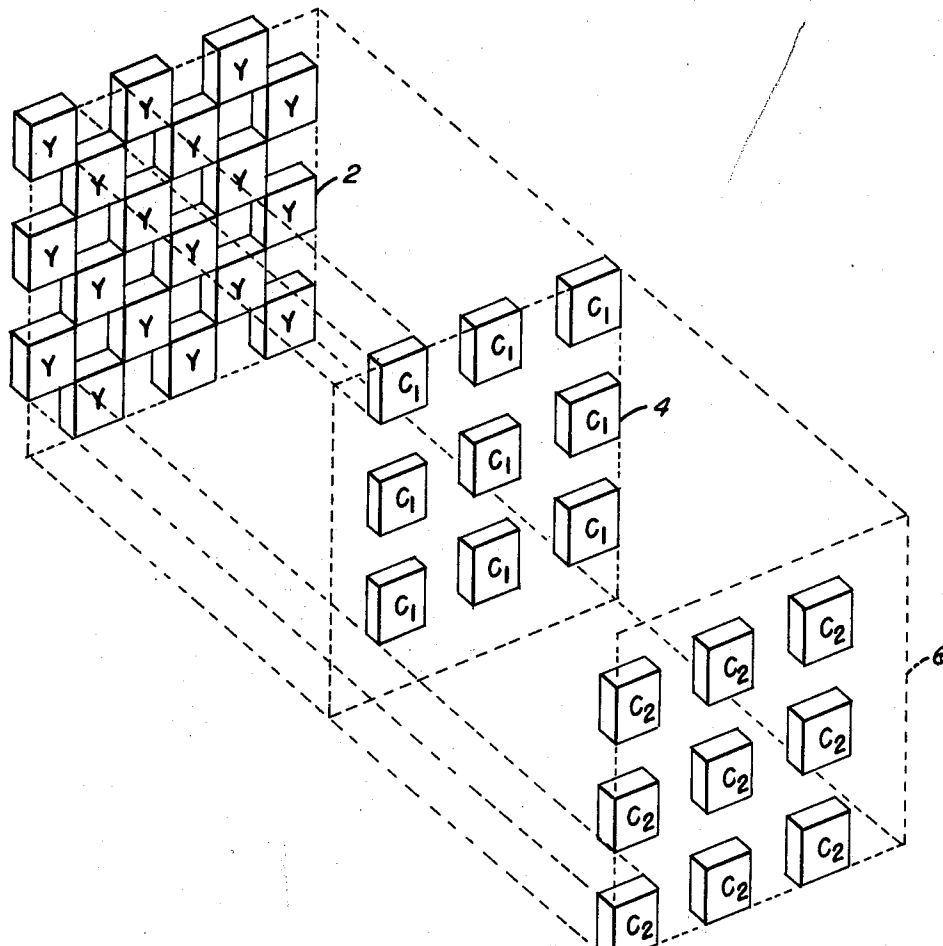

Y	C ₂	Y	C ₂	Y	C ₂
C ₁	Y	C ₁	Y	C ₁	Y
Y	C ₂	Y	C ₂	Y	C ₂
C ₁	Y	C ₁	Y	C ₁	Y
Y	C ₂	Y	C ₂	Y	C ₂
C ₁	Y	C ₁	Y	C ₁	Y
Y	C ₂	Y	C ₂	Y	C ₂
C ₁	Y	C ₁	Y	C ₁	Y

8

FIG. 1B

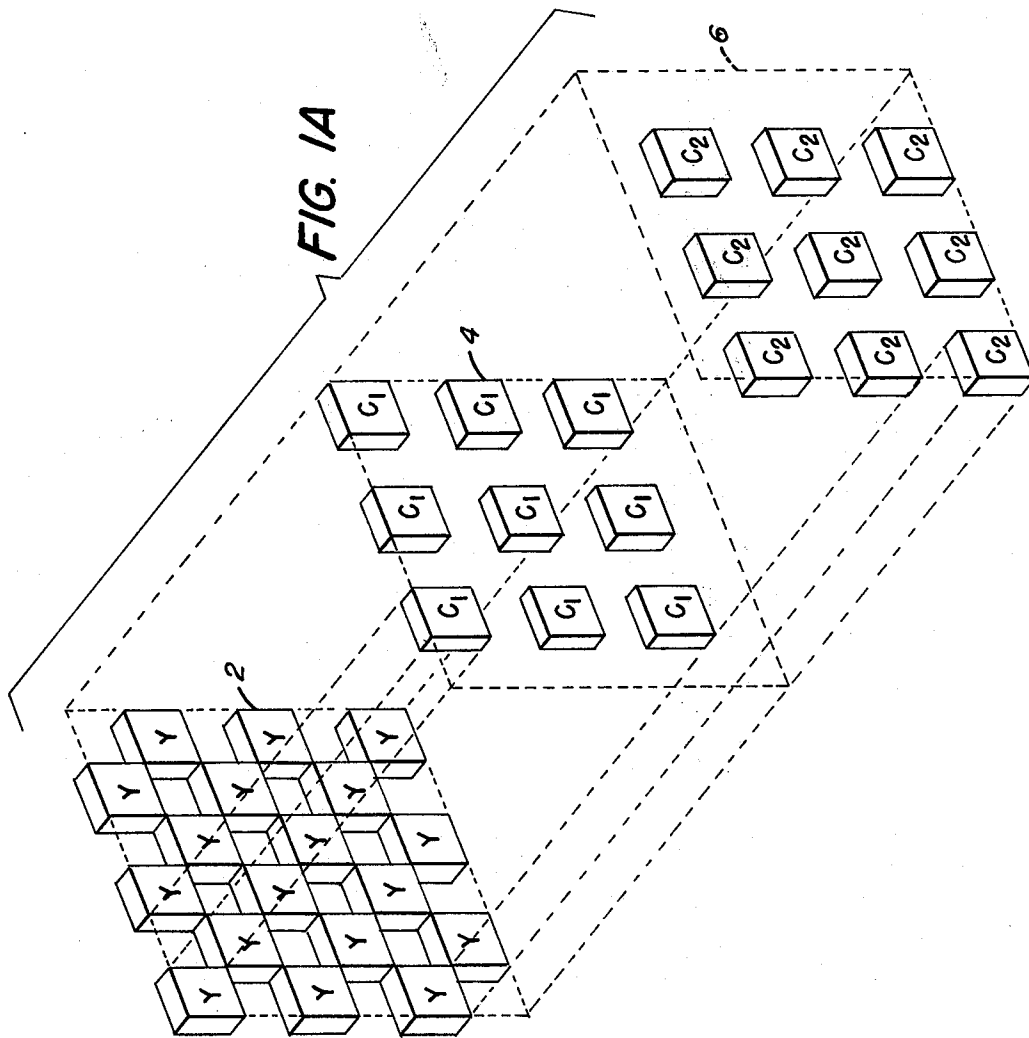

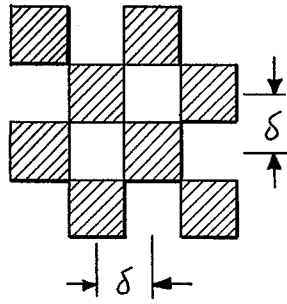

FIG. 2A

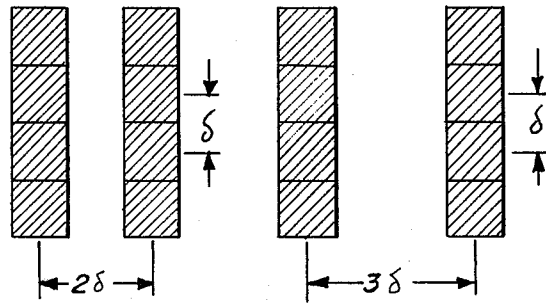

FIG. 2B

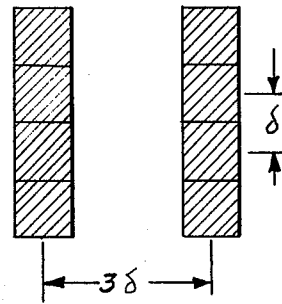

FIG. 2C

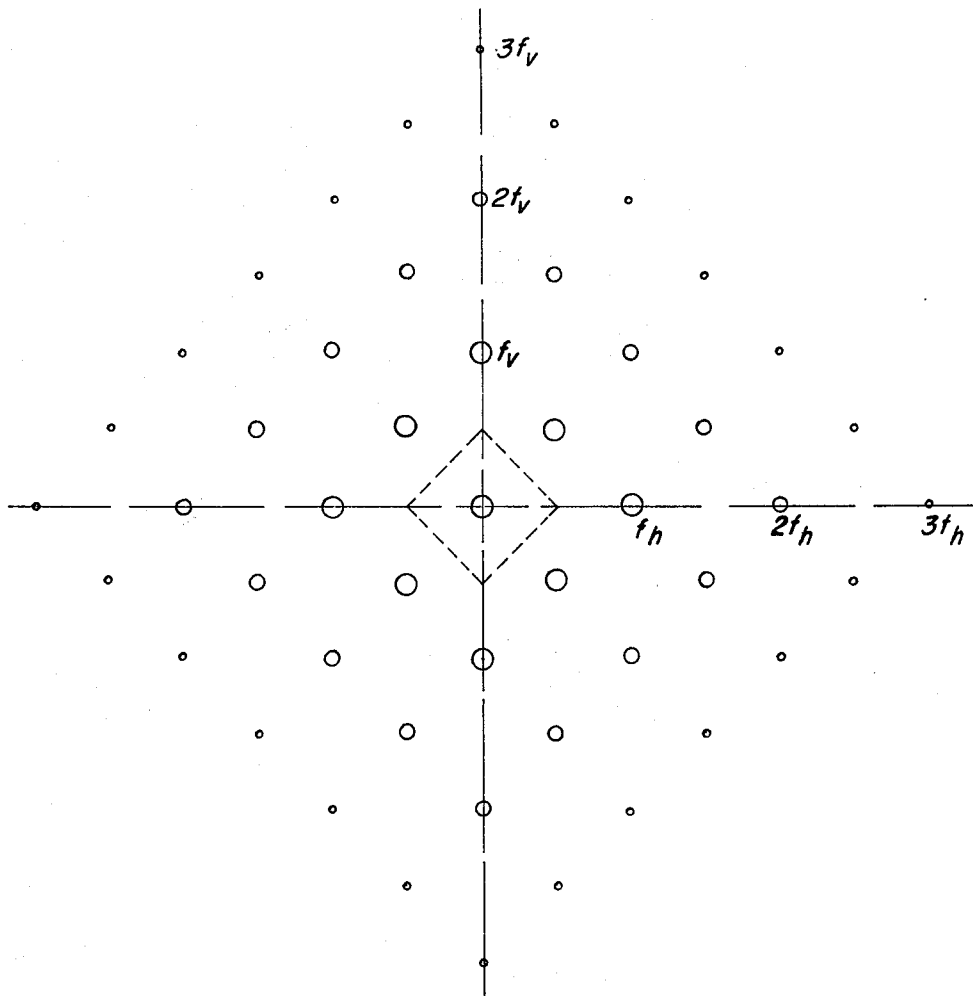

FIG. 2D

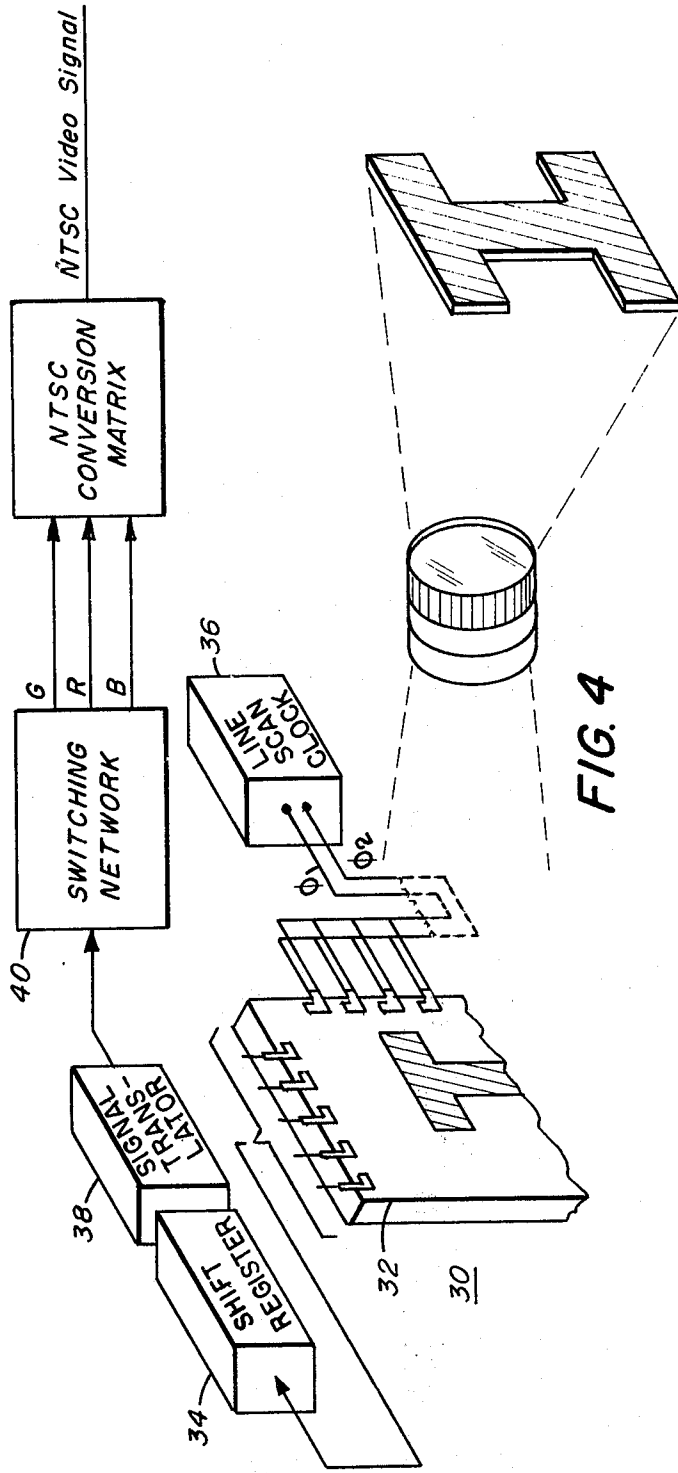

FIG. 4

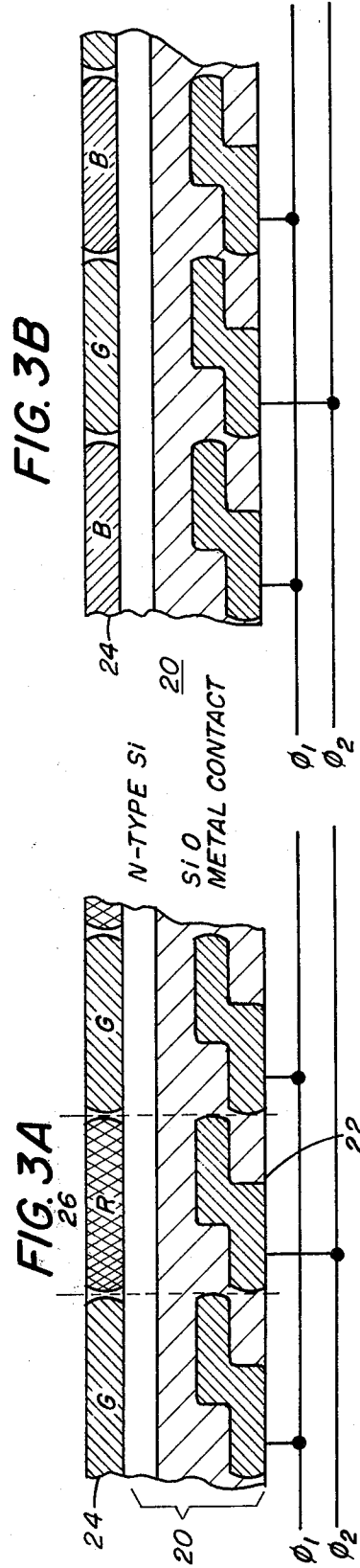

FIG. 3B

FIG. 3A

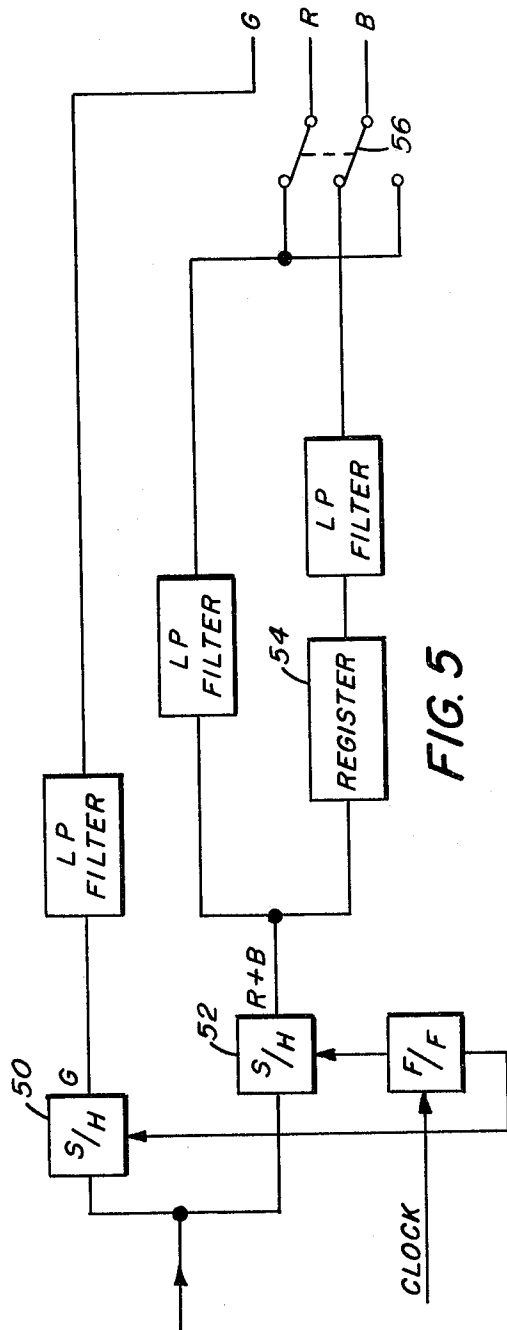

FIG. 5

G	R	G	R	G	R
B	G	R	G	B	G
G	R	G	R	G	R
R	G	B	G	R	G
G	R	G	R	G	R
B	G	R	G	B	G

FIG. 6

Explore Litigation Insights

Docket Alarm provides insights to develop a more informed litigation strategy and the peace of mind of knowing you're on top of things.

Real-Time Litigation Alerts



Keep your litigation team up-to-date with **real-time alerts** and advanced team management tools built for the enterprise, all while greatly reducing PACER spend.

Our comprehensive service means we can handle Federal, State, and Administrative courts across the country.

Advanced Docket Research



With over 230 million records, Docket Alarm's cloud-native docket research platform finds what other services can't. Coverage includes Federal, State, plus PTAB, TTAB, ITC and NLRB decisions, all in one place.

Identify arguments that have been successful in the past with full text, pinpoint searching. Link to case law cited within any court document via Fastcase.

Analytics At Your Fingertips



Learn what happened the last time a particular judge, opposing counsel or company faced cases similar to yours.

Advanced out-of-the-box PTAB and TTAB analytics are always at your fingertips.

API

Docket Alarm offers a powerful API (application programming interface) to developers that want to integrate case filings into their apps.

LAW FIRMS

Build custom dashboards for your attorneys and clients with live data direct from the court.

Automate many repetitive legal tasks like conflict checks, document management, and marketing.

FINANCIAL INSTITUTIONS

Litigation and bankruptcy checks for companies and debtors.

E-DISCOVERY AND LEGAL VENDORS

Sync your system to PACER to automate legal marketing.