

(12) **United States Patent**  
Nix

(10) **Patent No.:** US 10,027,505 B2  
(45) **Date of Patent:** Jul. 17, 2018

(54) **METHOD, APPARATUS AND SYSTEM FOR RETROFITTING A VEHICLE**

USPC .. 455/404.1-2, 435.2, 435.3, 521, 445, 466, 455/527, 552.1  
See application file for complete search history.

(71) Applicant: **Sucess LLC**, Birmingham, MI (US)

(56) **References Cited**

(72) Inventor: **Axel Nix**, Birmingham, MI (US)

U.S. PATENT DOCUMENTS

(73) Assignee: **Sucess LLC**, Birmingham, MI (US)

(\* ) Notice: Subject to any disclaimer, the term of this patent is extended or adjusted under 35 U.S.C. 154(b) by 0 days.

5,572,204	A	11/1996	Timm et al.
6,028,537	A	2/2000	Suman et al.
6,330,499	B1	12/2001	Chou et al.
6,493,629	B1	12/2002	Van Bosch
6,535,743	B1	3/2003	Kennedy et al.
6,617,979	B2	9/2003	Yoshioka
6,665,601	B1*	12/2003	Nielsen ..... H04L 12/40 701/50
6,690,302	B1	2/2004	Inomata
6,748,211	B1	6/2004	Isaac et al.
6,812,832	B2	11/2004	Lobaza et al.
7,016,656	B2	3/2006	Odashima et al.
7,129,826	B2	10/2006	Nitz et al.
7,206,672	B2	4/2007	Mueller

(Continued)

(21) Appl. No.: **15/442,640**

(22) Filed: **Feb. 25, 2017**

(65) **Prior Publication Data**

US 2017/0170984 A1 Jun. 15, 2017

**Related U.S. Application Data**

(63) Continuation of application No. 14/846,811, filed on Sep. 6, 2015, now Pat. No. 9,661,664, which is a continuation of application No. 11/742,574, filed on Apr. 30, 2007, now Pat. No. 9,161,195.

**OTHER PUBLICATIONS**

Axel Nix, U.S. Appl. No. 15/482,781, not published.

*Primary Examiner* — Cong Tran

(74) *Attorney, Agent, or Firm* — Smartpat PLC

(51) **Int. Cl.**

<b>H04W 4/22</b>	(2009.01)
<b>H04L 12/40</b>	(2006.01)
<b>H04W 76/00</b>	(2018.01)
<b>H04W 4/90</b>	(2018.01)
<b>H04W 76/50</b>	(2018.01)

(57) **ABSTRACT**

A system, apparatus, and method for retrofitting a vehicle are presented. The method relates to a vehicle with a factory-installed first apparatus which communicates with a factory-installed second apparatus through a vehicle data bus using a first message. The method includes electrically disconnecting the vehicle data bus between the first apparatus and the second apparatus and electrically connecting a retrofit apparatus to the vehicle data bus. The method further includes transmitting a second message from the retrofit apparatus to the first apparatus which is indistinguishable from the first message.

(52) **U.S. Cl.**

CPC ..... **H04L 12/40169** (2013.01); **H04W 4/22** (2013.01); **H04W 4/90** (2018.02); **H04W 76/007** (2013.01); **H04W 76/50** (2018.02); **H04L 2012/40215** (2013.01); **H04L 2012/40273** (2013.01)

(58) **Field of Classification Search**

CPC ..... H04W 76/007; H04W 4/22; H04B 1/3822

**16 Claims, 7 Drawing Sheets**

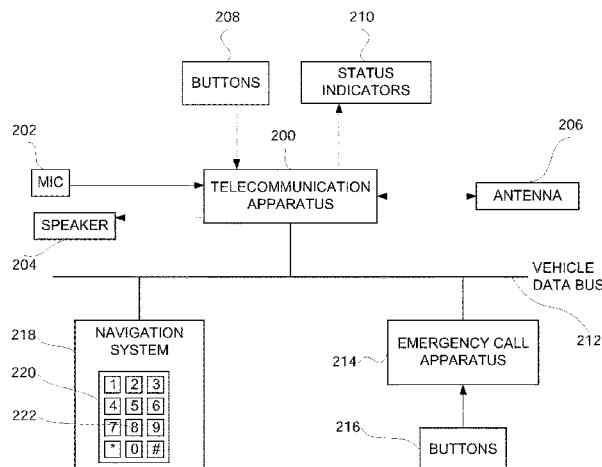

(56)

**References Cited**

U.S. PATENT DOCUMENTS

7,398,082	B2	7/2008	Schwinke et al.	
2002/0046285	A1	4/2002	Yasushi et al.	
2002/0103622	A1	8/2002	Burge	
2002/0115423	A1	8/2002	Hatae et al.	
2004/0091085	A1	5/2004	Suganuma et al.	
2004/0198466	A1	10/2004	Walby et al.	
2004/0233045	A1	11/2004	Mays	
2006/0017612	A1*	1/2006	Nagatani .....	G01S 5/0027 342/357.64
2006/0136291	A1*	6/2006	Morita .....	G06Q 30/02 705/13
2006/0220806	A1	10/2006	Nguyen	
2007/0075919	A1	4/2007	Breed	
2007/0086579	A1	4/2007	Lorello et al.	
2007/0112476	A1	5/2007	Obradovich	
2007/0174467	A1	7/2007	Ballou et al.	
2007/0207772	A1	9/2007	Huber et al.	
2007/0298765	A1	12/2007	Dickinson et al.	
2008/0143497	A1	6/2008	Wasson et al.	
2008/0162042	A1	7/2008	Huber et al.	
2013/0159586	A1	6/2013	Kessler	

\* cited by examiner

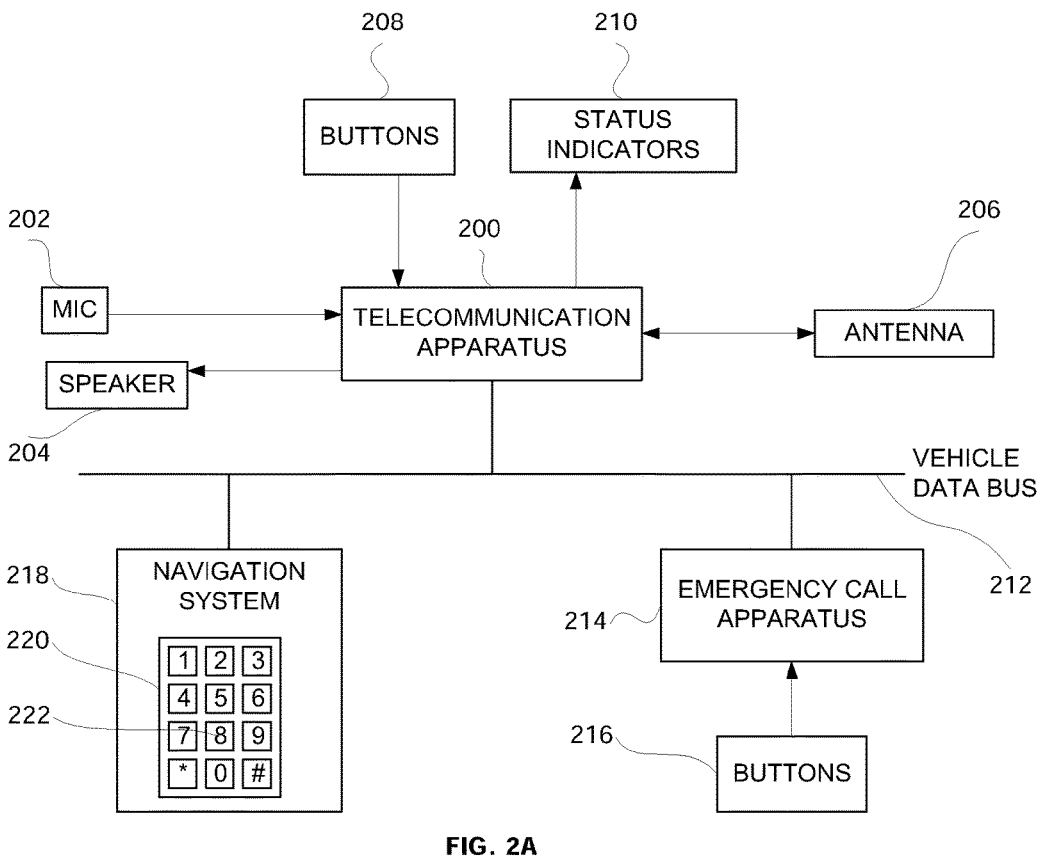
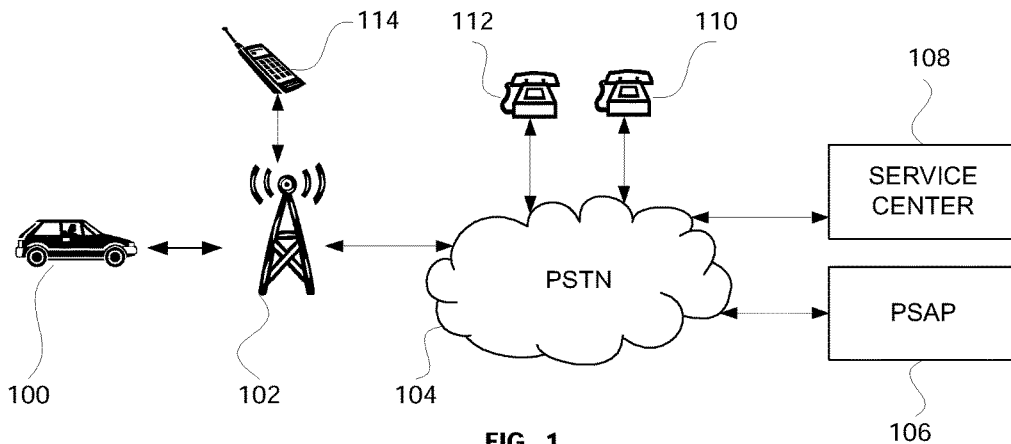

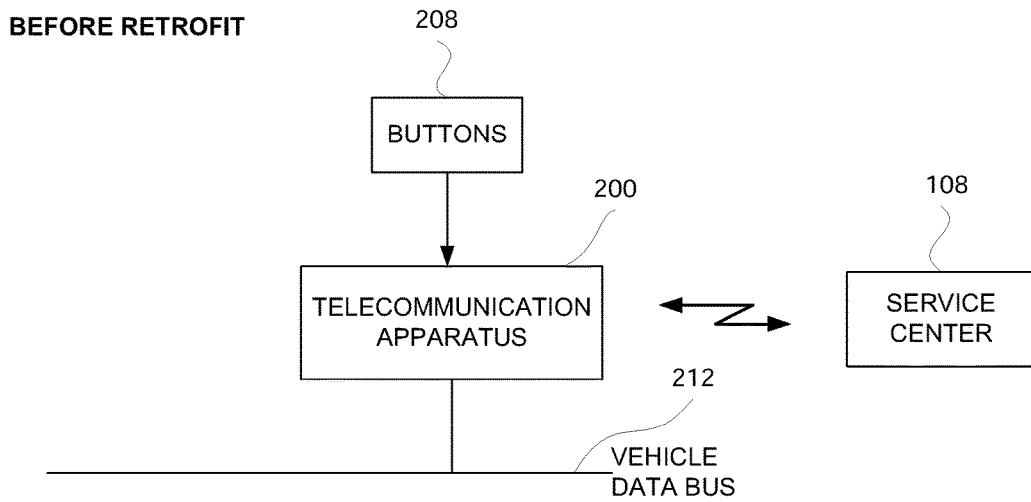

FIG. 2B (PRIOR ART)

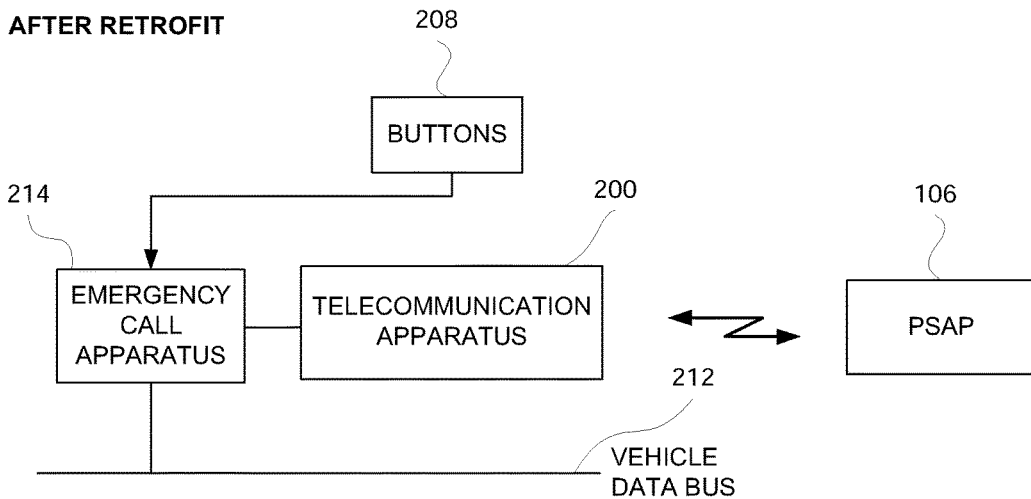

FIG. 2C

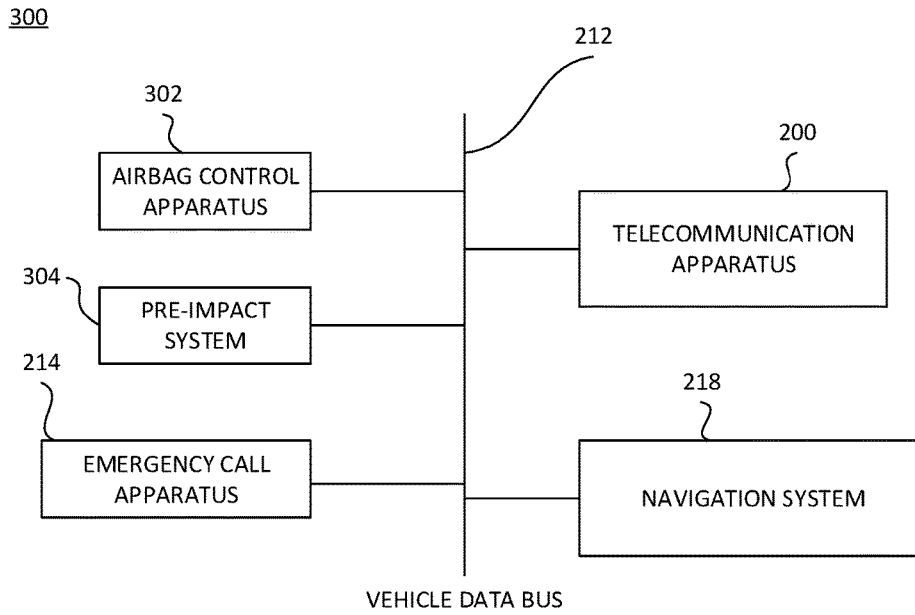

FIG. 3

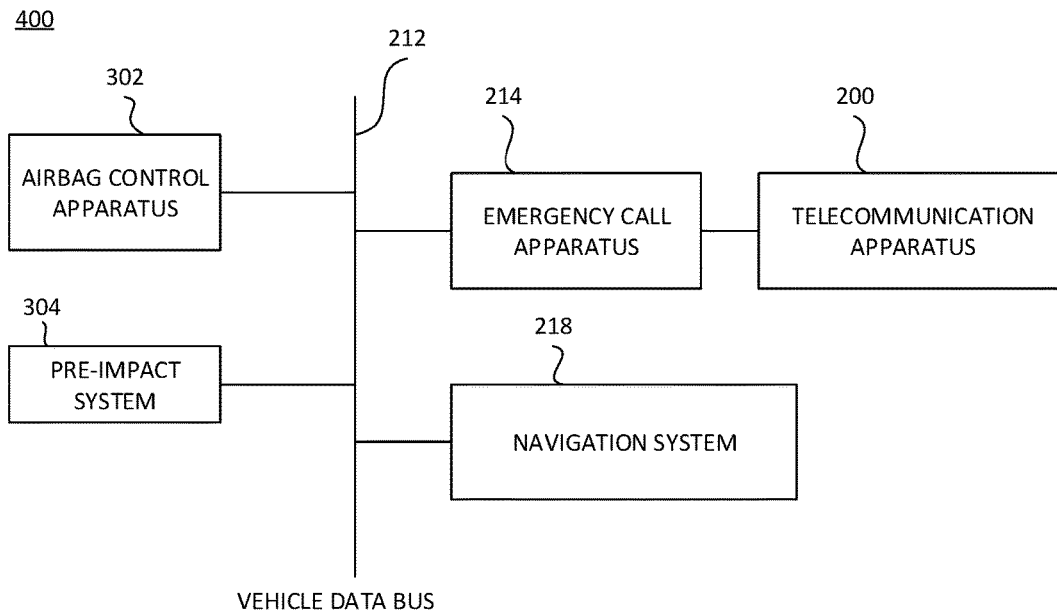

FIG. 4

# Explore Litigation Insights

Docket Alarm provides insights to develop a more informed litigation strategy and the peace of mind of knowing you're on top of things.

## Real-Time Litigation Alerts



Keep your litigation team up-to-date with **real-time alerts** and advanced team management tools built for the enterprise, all while greatly reducing PACER spend.

Our comprehensive service means we can handle Federal, State, and Administrative courts across the country.

## Advanced Docket Research



With over 230 million records, Docket Alarm's cloud-native docket research platform finds what other services can't. Coverage includes Federal, State, plus PTAB, TTAB, ITC and NLRB decisions, all in one place.

Identify arguments that have been successful in the past with full text, pinpoint searching. Link to case law cited within any court document via Fastcase.

## Analytics At Your Fingertips



Learn what happened the last time a particular judge, opposing counsel or company faced cases similar to yours.

Advanced out-of-the-box PTAB and TTAB analytics are always at your fingertips.

## API

Docket Alarm offers a powerful API (application programming interface) to developers that want to integrate case filings into their apps.

## LAW FIRMS

Build custom dashboards for your attorneys and clients with live data direct from the court.

Automate many repetitive legal tasks like conflict checks, document management, and marketing.

## FINANCIAL INSTITUTIONS

Litigation and bankruptcy checks for companies and debtors.

## E-DISCOVERY AND LEGAL VENDORS

Sync your system to PACER to automate legal marketing.