

**This application is officially maintained in electronic form. To View: Click the desired Document Description. To Download and Print: Check the desired document(s) and click Start Download.**

**Available Documents**

Mail Room Date	Document Code	Document Description	Document Category	Page Count
11-21-2019	SOL.NTC.SUIT	Report on the filing or determination of an action regarding a patent	PROSECUTION	1
08-20-2019	SOL.NTC.SUIT	Report on the filing or determination of an action regarding a patent	PROSECUTION	1
08-20-2019	SOL.NTC.SUIT	Report on the filing or determination of an action regarding a patent	PROSECUTION	1
06-25-2019	SOL.NTC.SUIT	Report on the filing or determination of an action regarding a patent	PROSECUTION	1
09-14-2018	SOL.NTC.SUIT	Report on the filing or determination of an action regarding a patent	PROSECUTION	1
06-21-2018	TRIAL.REQ.D	Request for Trial Denied	PROSECUTION	14
06-18-2018	SOL.NTC.SUIT	Report on the filing or determination of an action regarding a patent	PROSECUTION	1
06-18-2018	SOL.NTC.SUIT	Report on the filing or determination of an action regarding a patent	PROSECUTION	1
03-08-2018	SOL.NTC.SUIT	Report on the filing or determination of an action regarding a patent	PROSECUTION	1
03-08-2018	SOL.NTC.SUIT	Report on the filing or determination of an action regarding a patent	PROSECUTION	1
02-20-2018	SOL.NTC.SUIT	Report on the filing or determination of an action regarding a patent	PROSECUTION	1
01-11-2018	TRIAL.CERT.M	Trial Certificate Mailed	PROSECUTION	2
09-27-2017	TRIAL.TRMFWD	Trial Termination or Final Written Decision	PROSECUTION	4
09-06-2017	SOL.NTC.SUIT	Report on the filing or determination of an action regarding a patent	PROSECUTION	1
07-05-2017	TRIAL.REQ.G	Request for Trial Granted	PROSECUTION	50
06-30-2017	SOL.NTC.SUIT	Report on the filing or determination of an action regarding a patent	PROSECUTION	2
06-20-2017	SOL.NTC.SUIT	Report on the filing or determination of an action regarding a patent	PROSECUTION	2
06-02-2017	LET.	Miscellaneous Incoming Letter	PROSECUTION	2
06-02-2017	N417	EFS Acknowledgment Receipt	PROSECUTION	2
05-09-2017	SOL.NTC.SUIT	Report on the filing or determination of an action regarding a patent	PROSECUTION	1
04-28-2017	SOL.NTC.SUIT	Report on the filing or determination of an action regarding a patent	PROSECUTION	1
04-28-2017	SOL.NTC.SUIT	Report on the filing or determination of an action regarding a patent	PROSECUTION	3
04-26-2017	SOL.NTC.SUIT	Report on the filing or determination of an action regarding a patent	PROSECUTION	1
04-26-2017	SOL.NTC.SUIT	Report on the filing or determination of an action regarding a patent	PROSECUTION	1
04-26-2017	TRIAL.TRMFWD	Trial Termination or Final Written Decision	PROSECUTION	5
04-25-2017	SOL.NTC.SUIT	Report on the filing or determination of an action regarding a patent	PROSECUTION	3
04-25-2017	SOL.NTC.SUIT	Report on the filing or determination of an action regarding a patent	PROSECUTION	6
04-25-2017	SOL.NTC.SUIT	Report on the filing or determination of an action regarding a patent	PROSECUTION	1
04-25-2017	SOL.NTC.SUIT	Report on the filing or determination of an action regarding a patent	PROSECUTION	1
04-07-2017	SOL.NTC.SUIT	Report on the filing or determination of an action regarding a patent	PROSECUTION	7
04-07-2017	SOL.NTC.SUIT	Report on the filing or determination of an action regarding a patent	PROSECUTION	1

		regarding a patent		
03-13-2017	SOL.NTC.SUIT	Report on the filing or determination of an action regarding a patent	PROSECUTION	1
02-10-2017	LET.	Miscellaneous Incoming Letter	PROSECUTION	4
02-10-2017	N417	EFS Acknowledgment Receipt	PROSECUTION	2
02-06-2017	SOL.NTC.SUIT	Report on the filing or determination of an action regarding a patent	PROSECUTION	1
01-18-2017	LET.	Miscellaneous Incoming Letter	PROSECUTION	4
01-18-2017	N417	EFS Acknowledgment Receipt	PROSECUTION	2
12-30-2016	TRAN.LET	Transmittal Letter	PROSECUTION	1
12-30-2016	REF.OTHER	Other Reference-Patent/App/Search documents	PROSECUTION	14
12-30-2016	REF.OTHER	Other Reference-Patent/App/Search documents	PROSECUTION	31
12-30-2016	N417	EFS Acknowledgment Receipt	PROSECUTION	2
12-27-2016	SOL.NTC.SUIT	Report on the filing or determination of an action regarding a patent	PROSECUTION	1
12-27-2016	SOL.NTC.SUIT	Report on the filing or determination of an action regarding a patent	PROSECUTION	1
09-10-2016	SES.LOSS.ELC	Notification of loss of entitlement to small entity status via PAIR	PROSECUTION	1
08-16-2016	TRIAL.REQ.D	Request for Trial Denied	PROSECUTION	22
05-23-2016	SOL.NTC.SUIT	Report on the filing or determination of an action regarding a patent	PROSECUTION	1
05-02-2016	SOL.NTC.SUIT	Report on the filing or determination of an action regarding a patent	PROSECUTION	1
02-19-2016	SOL.NTC.SUIT	Report on the filing or determination of an action regarding a patent	PROSECUTION	3
02-19-2016	SOL.NTC.SUIT	Report on the filing or determination of an action regarding a patent	PROSECUTION	1
11-25-2015	SOL.NTC.SUIT	Report on the filing or determination of an action regarding a patent	PROSECUTION	1
06-18-2015	SOL.NTC.SUIT	Report on the filing or determination of an action regarding a patent	PROSECUTION	1
06-18-2015	SOL.NTC.SUIT	Report on the filing or determination of an action regarding a patent	PROSECUTION	1
05-26-2015	SOL.NTC.SUIT	Report on the filing or determination of an action regarding a patent	PROSECUTION	1
05-20-2015	SOL.NTC.SUIT	Report on the filing or determination of an action regarding a patent	PROSECUTION	1
05-15-2015	TRIAL.TRMFWD	Trial Termination or Final Written Decision	PROSECUTION	3
05-06-2015	SOL.NTC.SUIT	Report on the filing or determination of an action regarding a patent	PROSECUTION	1
03-25-2015	SOL.NTC.SUIT	Report on the filing or determination of an action regarding a patent	PROSECUTION	1
12-29-2014	REF.OTHER	Other Reference-Patent/App/Search documents	PROSECUTION	13
12-29-2014	N417	EFS Acknowledgment Receipt	PROSECUTION	2
12-29-2014	REF.OTHER	Other Reference-Patent/App/Search documents	PROSECUTION	7
12-29-2014	N417	EFS Acknowledgment Receipt	PROSECUTION	2
12-12-2014	NPL	Non Patent Literature	PROSECUTION	7
12-12-2014	N417	EFS Acknowledgment Receipt	PROSECUTION	2
11-24-2014	SOL.NTC.SUIT	Report on the filing or determination of an action regarding a patent	PROSECUTION	1
07-16-2014	SES.LOSS	Notification of loss of entitlement to small entity status	PROSECUTION	1
07-16-2014	N417	EFS Acknowledgment Receipt	PROSECUTION	2
06-16-2014	N417	EFS Acknowledgment Receipt	PROSECUTION	2
06-16-2014	LET.	Miscellaneous Incoming Letter	PROSECUTION	3
05-31-2014	LET.	Miscellaneous Incoming Letter	PROSECUTION	40
05-31-2014	N417	EFS Acknowledgment Receipt	PROSECUTION	2
05-31-2014	LET.	Miscellaneous Incoming Letter	PROSECUTION	40

05-31-2014	N417	EFS Acknowledgment Receipt	PROSECUTION	2
04-03-2014	SOL.NTC.SUIT	Report on the filing or determination of an action regarding a patent	PROSECUTION	9
04-01-2014	SOL.NTC.SUIT	Report on the filing or determination of an action regarding a patent	PROSECUTION	1
04-01-2014	LET.	Miscellaneous Incoming Letter	PROSECUTION	12
04-01-2014	N417	EFS Acknowledgment Receipt	PROSECUTION	2
03-13-2014	SOL.NTC.SUIT	Report on the filing or determination of an action regarding a patent	PROSECUTION	1
03-06-2014	SOL.NTC.SUIT	Report on the filing or determination of an action regarding a patent	PROSECUTION	1
12-19-2013	SOL.NTC.SUIT	Report on the filing or determination of an action regarding a patent	PROSECUTION	1
12-19-2013	SOL.NTC.SUIT	Report on the filing or determination of an action regarding a patent	PROSECUTION	1
12-19-2013	SOL.NTC.SUIT	Report on the filing or determination of an action regarding a patent	PROSECUTION	1
12-18-2013	SOL.NTC.SUIT	Report on the filing or determination of an action regarding a patent	PROSECUTION	1
12-17-2013	COCOUT	Certificate of Correction - Post Issue Communication	PROSECUTION	1
11-26-2013	COCX	SPE Response - Certificate of Correction under 1.323/1.324	PROSECUTION	1
11-25-2013	LET.	Miscellaneous Incoming Letter	PROSECUTION	1
11-25-2013	N417	EFS Acknowledgment Receipt	PROSECUTION	2
11-18-2013	IMIS	Miscellaneous Internal Document	PROSECUTION	1
11-12-2013	COCOUT	Certificate of Correction - Post Issue Communication	PROSECUTION	2
10-19-2013	LET.	Miscellaneous Incoming Letter	PROSECUTION	3
10-19-2013	N417	EFS Acknowledgment Receipt	PROSECUTION	2
10-17-2013	COCX	SPE Response - Certificate of Correction under 1.323/1.324	PROSECUTION	1
10-13-2013	COCIN	Request for Certificate of Correction	PROSECUTION	2
10-13-2013	WFEE	Fee Worksheet (SB06)	PROSECUTION	2
10-13-2013	N417	EFS Acknowledgment Receipt	PROSECUTION	2
09-19-2013	IMIS	Miscellaneous Internal Document	PROSECUTION	1
09-16-2013	COCIN	Request for Certificate of Correction	PROSECUTION	2
09-16-2013	COCIN	Request for Certificate of Correction	PROSECUTION	1
09-16-2013	WFEE	Fee Worksheet (SB06)	PROSECUTION	2
09-16-2013	N417	EFS Acknowledgment Receipt	PROSECUTION	2
09-13-2013	COCIN	Request for Certificate of Correction	PROSECUTION	2
09-13-2013	COCIN	Request for Certificate of Correction	PROSECUTION	4
09-13-2013	N417	EFS Acknowledgment Receipt	PROSECUTION	2
09-10-2013	COCIN	Request for Certificate of Correction	PROSECUTION	2
09-10-2013	COCIN	Request for Certificate of Correction	PROSECUTION	1
09-10-2013	WFEE	Fee Worksheet (SB06)	PROSECUTION	2
09-10-2013	N417	EFS Acknowledgment Receipt	PROSECUTION	2
08-21-2013	ISSUE.NTF	Issue Notification	PROSECUTION	1
08-05-2013	N271	Response to Amendment under Rule 312	PROSECUTION	14
08-05-2013	ANE.I	Amendment After Final or under 37CFR 1.312, initialed by the examiner.	PROSECUTION	1
08-05-2013	N271	Response to Amendment under Rule 312	PROSECUTION	1
08-01-2013	M327	Miscellaneous Communication to Applicant - No Action Count	PROSECUTION	3
08-01-2013	TRAN.LET	Transmittal Letter	PROSECUTION	1
08-01-2013	N417	EFS Acknowledgment Receipt	PROSECUTION	2
08-01-2013	ADS	Application Data Sheet	PROSECUTION	4
05-31-2013	NOA	Notice of Allowance and Fees Due (PTOL-85)	PROSECUTION	21
05-31-2013	892	List of references cited by examiner	PROSECUTION	1

05-31-2013	1449	List of References cited by applicant and considered by examiner	PROSECUTION	6
05-31-2013	BIB	Bibliographic Data Sheet	PROSECUTION	1
05-31-2013	1449	List of References cited by applicant and considered by examiner	PROSECUTION	6
05-31-2013	1449	List of References cited by applicant and considered by examiner	PROSECUTION	6
05-31-2013	1449	List of References cited by applicant and considered by examiner	PROSECUTION	4
05-31-2013	SRFW	Search information including classification, databases and other search related notes	PROSECUTION	1
05-31-2013	IIFW	Issue Information including classification, examiner, name, claim, renumbering, etc.	PROSECUTION	3
05-31-2013	SRNT	Examiner's search strategy and results	PROSECUTION	20
05-31-2013	FWCLM	Index of Claims	PROSECUTION	1
05-31-2013	IFEE	Issue Fee Payment (PTO-85B)	PROSECUTION	2
05-31-2013	A.NA	Amendment after Notice of Allowance (Rule 312)	PROSECUTION	1
05-31-2013	CLM	Claims	PROSECUTION	15
05-31-2013	WFEE	Fee Worksheet (SB06)	PROSECUTION	2
05-31-2013	N417	EFS Acknowledgment Receipt	PROSECUTION	2
02-20-2013	TRACK1.GRANT	TrackOne Request Granted	PROSECUTION	1
02-16-2013	DIST.E.FILE	Terminal Disclaimer-Filed (Electronic)	PROSECUTION	2
02-16-2013	WFEE	Fee Worksheet (SB06)	PROSECUTION	2
02-16-2013	DISQ.E.FILE	Terminal Disclaimer-Electronic-Approved	PROSECUTION	1
02-16-2013	N417	EFS Acknowledgment Receipt	PROSECUTION	2
02-16-2013	A.PE	Preliminary Amendment	PROSECUTION	1
02-16-2013	CLM	Claims	PROSECUTION	11
02-16-2013	N417	EFS Acknowledgment Receipt	PROSECUTION	2
02-16-2013	WFEE	Fee Worksheet (SB06)	PROSECUTION	1
02-12-2013	APP.FILE.REC	Filing Receipt	PROSECUTION	3
02-12-2013	WFEE	Fee Worksheet (SB06)	PROSECUTION	1
02-04-2013	IDS	Information Disclosure Statement (IDS) Form (SB08)	PROSECUTION	4
02-04-2013	NPL	Non Patent Literature	PROSECUTION	89
02-04-2013	N417	EFS Acknowledgment Receipt	PROSECUTION	2
01-31-2013	A.PE	Preliminary Amendment	PROSECUTION	1
01-31-2013	CLM	Claims	PROSECUTION	11
01-31-2013	N417	EFS Acknowledgment Receipt	PROSECUTION	2
01-30-2013	A.PE	Preliminary Amendment	PROSECUTION	1
01-30-2013	CLM	Claims	PROSECUTION	11
01-30-2013	N417	EFS Acknowledgment Receipt	PROSECUTION	2
01-13-2013	IDS	Information Disclosure Statement (IDS) Form (SB08)	PROSECUTION	6
01-13-2013	IDS	Information Disclosure Statement (IDS) Form (SB08)	PROSECUTION	6
01-13-2013	TRAN.LET	Transmittal Letter	PROSECUTION	1
01-13-2013	NPL	Non Patent Literature	PROSECUTION	174
01-13-2013	N417	EFS Acknowledgment Receipt	PROSECUTION	2
01-13-2013	TRAN.LET	Transmittal Letter	PROSECUTION	1
01-11-2013	TRNA	Transmittal of New Application	PROSECUTION	1
01-11-2013	OATH	Oath or Declaration filed	PROSECUTION	4
01-11-2013	TRACK1.REQ	TrackOne Request	PROSECUTION	1
01-11-2013	WFEE	Fee Worksheet (SB06)	PROSECUTION	2
01-11-2013	N417	EFS Acknowledgment Receipt	PROSECUTION	3
01-11-2013	DRW	Drawings-only black and white line drawings	PROSECUTION	7
01-11-2013	TRAN.LET	Transmittal Letter	PROSECUTION	1
01-11-2013	IDS	Information Disclosure Statement (IDS) Form (SB08)	PROSECUTION	6



01-11-2013	SPEC	Specification	PROSECUTION	25
01-11-2013	CLM	Claims	PROSECUTION	9
01-11-2013	ABST	Abstract	PROSECUTION	1

---

[Close Window](#)

AO 120 (Rev. 08/10)

<b>TO:</b> <p style="text-align: center;"><b>Mail Stop 8</b>  <b>Director of the U.S. Patent and Trademark Office</b>  <b>P.O. Box 1450</b>  <b>Alexandria, VA 22313-1450</b></p>	<p><b>REPORT ON THE              FILING OR DETERMINATION OF AN              ACTION REGARDING A PATENT OR              TRADEMARK</b></p>
--	---

In Compliance with 35 U.S.C. § 290 and/or 15 U.S.C. § 1116 you are hereby advised that a court action has been filed in the U.S. District Court Northern District of Illinois on the following

Trademarks or  Patents. (  the patent action involves 35 U.S.C. § 292.):

DOCKET NO. 17cv7300	DATE FILED 10/10/2017	U.S. DISTRICT COURT Northern District of Illinois
PLAINTIFF William Grecia		DEFENDANT Discover Financial Services, Inc.
PATENT OR TRADEMARK NO.	DATE OF PATENT OR TRADEMARK	HOLDER OF PATENT OR TRADEMARK
1 8,887,308 B2	11/11/2014	William Grecia
2 8,533,860 B1	9/10/2013	William Grecia
3 8,402,555 B2	3/19/2013	William Grecia
4		
5		

In the above—entitled case, the following patent(s)/ trademark(s) have been included:

DATE INCLUDED	INCLUDED BY <input type="checkbox"/> Amendment <input type="checkbox"/> Answer <input type="checkbox"/> Cross Bill <input type="checkbox"/> Other Pleading	
PATENT OR TRADEMARK NO.	DATE OF PATENT OR TRADEMARK	HOLDER OF PATENT OR TRADEMARK
1		
2		
3		
4		
5		

In the above—entitled case, the following decision has been rendered or judgement issued:

DECISION/JUDGEMENT
--------------------

CLERK Thomas G. Bruton	(BY) DEPUTY CLERK Anya Ellis	DATE 11/21/2018
---------------------------	---------------------------------	--------------------

Copy 1—Upon initiation of action, mail this copy to Director Copy 3—Upon termination of action, mail this copy to Director  
 Copy 2—Upon filing document adding patent(s), mail this copy to Director Copy 4—Case file copy

AO 120 (Rev. 08/10)

TO: <b>Mail Stop 8</b> <b>Director of the U.S. Patent and Trademark Office</b> P.O. Box 1450 Alexandria, VA 22313-1450	<b>REPORT ON THE                  FILING OR DETERMINATION OF AN                  ACTION REGARDING A PATENT OR                  TRADEMARK</b>
---	--

In Compliance with 35 U.S.C. § 290 and/or 15 U.S.C. § 1116 you are hereby advised that a court action has been filed in the U.S. District Court Northern District of Illinois on the following

Trademarks or  Patents. (  the patent action involves 35 U.S.C. § 292.):

DOCKET NO. 18 cv 1848	DATE FILED 3/14/2018	U.S. DISTRICT COURT Northern District of Illinois
PLAINTIFF WILLIAM GRECIA		DEFENDANT WALGREEN CO.,
PATENT OR TRADEMARK NO.	DATE OF PATENT OR TRADEMARK	HOLDER OF PATENT OR TRADEMARK
1 <u>See Attachment</u>		
2 8533860		
3		
4		
5		

In the above—entitled case, the following patent(s)/ trademark(s) have been included:

DATE INCLUDED	INCLUDED BY		
	<input type="checkbox"/> Amendment <input type="checkbox"/> Answer <input type="checkbox"/> Cross Bill <input type="checkbox"/> Other Pleading		
PATENT OR TRADEMARK NO.	DATE OF PATENT OR TRADEMARK	HOLDER OF PATENT OR TRADEMARK	
1			
2			
3			
4			
5			

In the above—entitled case, the following decision has been rendered or judgement issued:

DECISION/JUDGEMENT
--------------------

CLERK Thomas G. Bruton	(BY) DEPUTY CLERK Yvette Pearson	DATE 3/14/2018
---------------------------	-------------------------------------	-------------------

Copy 1—Upon initiation of action, mail this copy to Director    Copy 3—Upon termination of action, mail this copy to Director  
 Copy 2—Upon filing document adding patent(s), mail this copy to Director    Copy 4—Case file copy

AO 120 (Rev. 08/10)

<b>TO:</b> Mail Stop 8 Director of the U.S. Patent and Trademark Office P.O. Box 1450 Alexandria, VA 22313-1450	<b>REPORT ON THE                  FILING OR DETERMINATION OF AN                  ACTION REGARDING A PATENT OR                  TRADEMARK</b>
---	--

In Compliance with 35 U.S.C. § 290 and/or 15 U.S.C. § 1116 you are hereby advised that a court action has been filed in the U.S. District Court Northern District of Illinois on the following

Trademarks or  Patents. (  the patent action involves 35 U.S.C. § 292.):

DOCKET NO. 18 cv 1848	DATE FILED 3/14/2018	U.S. DISTRICT COURT Northern District of Illinois
PLAINTIFF WILLIAM GRECIA		DEFENDANT WALGREEN CO.,
PATENT OR TRADEMARK NO.	DATE OF PATENT OR TRADEMARK	HOLDER OF PATENT OR TRADEMARK
1 See Attachment 2		
2 8533860		
3		
4		
5		

In the above—entitled case, the following patent(s)/ trademark(s) have been included:

DATE INCLUDED	INCLUDED BY <input type="checkbox"/> Amendment <input type="checkbox"/> Answer <input type="checkbox"/> Cross Bill <input type="checkbox"/> Other Pleading
PATENT OR TRADEMARK NO.	DATE OF PATENT OR TRADEMARK HOLDER OF PATENT OR TRADEMARK
1	
2	
3	
4	
5	

In the above—entitled case, the following decision has been rendered or judgement issued:

DECISION/JUDGEMENT
--------------------

CLERK Thomas G. Bruton	(BY) DEPUTY CLERK Yvette Pearson	DATE 3/14/2018
---------------------------	-------------------------------------	-------------------

Copy 1—Upon initiation of action, mail this copy to Director    Copy 3—Upon termination of action, mail this copy to Director  
 Copy 2—Upon filing document adding patent(s), mail this copy to Director    Copy 4—Case file copy

AO 120 (Rev. 08/10)

<b>TO:</b> Mail Stop 8 Director of the U.S. Patent and Trademark Office P.O. Box 1450 Alexandria, VA 22313-1450	<b>REPORT ON THE                  FILING OR DETERMINATION OF AN                  ACTION REGARDING A PATENT OR                  TRADEMARK</b>
--	--

In Compliance with 35 U.S.C. § 290 and/or 15 U.S.C. § 1116 you are hereby advised that a court action has been filed in the U.S. District Court Northern District of Illinois on the following

Trademarks or  Patents. (  the patent action involves 35 U.S.C. § 292.):

DOCKET NO. 1:18-cv-1885	DATE FILED 3/15/2018	U.S. DISTRICT COURT Northern District of Illinois
PLAINTIFF William Grecia		DEFENDANT Sears Holdings Corporation
PATENT OR TRADEMARK NO.	DATE OF PATENT OR TRADEMARK	HOLDER OF PATENT OR TRADEMARK
1 8533860		See attachment
2		
3		
4		
5		

In the above—entitled case, the following patent(s)/ trademark(s) have been included:

DATE INCLUDED	INCLUDED BY	<input type="checkbox"/> Amendment <input type="checkbox"/> Answer <input type="checkbox"/> Cross Bill <input type="checkbox"/> Other Pleading
PATENT OR TRADEMARK NO.	DATE OF PATENT OR TRADEMARK	HOLDER OF PATENT OR TRADEMARK
1		
2		
3		
4		
5		

In the above—entitled case, the following decision has been rendered or judgement issued:

DECISION/JUDGEMENT
--------------------

CLERK Thomas G. Bruton	(BY) DEPUTY CLERK Michelle Copeland	DATE 3/16/2018
---------------------------	--	-------------------

Copy 1—Upon initiation of action, mail this copy to Director    Copy 3—Upon termination of action, mail this copy to Director  
 Copy 2—Upon filing document adding patent(s), mail this copy to Director    Copy 4—Case file copy

AO 120 (Rev. 08/10)

TO: <b>Mail Stop 8</b> <b>Director of the U.S. Patent and Trademark Office</b> <b>P.O. Box 1450</b> <b>Alexandria, VA 22313-1450</b>	<b>REPORT ON THE</b> <b>FILING OR DETERMINATION OF AN</b> <b>ACTION REGARDING A PATENT OR</b> <b>TRADEMARK</b>
---	---

In Compliance with 35 U.S.C. § 290 and/or 15 U.S.C. § 1116 you are hereby advised that a court action has been filed in the U.S. District Court Northern District of Illinois on the following

Trademarks or  Patents. (  the patent action involves 35 U.S.C. § 292.):

DOCKET NO. 1:18-cv-1886	DATE FILED 3/15/2018	U.S. DISTRICT COURT Northern District of Illinois
PLAINTIFF William Grecia		DEFENDANT True Value Company
PATENT OR TRADEMARK NO.	DATE OF PATENT OR TRADEMARK	HOLDER OF PATENT OR TRADEMARK
1 8,533,860	9/10/2013	Grecia
2		
3		
4		
5		

In the above—entitled case, the following patent(s)/ trademark(s) have been included:

DATE INCLUDED	INCLUDED BY <input type="checkbox"/> Amendment <input type="checkbox"/> Answer <input type="checkbox"/> Cross Bill <input type="checkbox"/> Other Pleading
PATENT OR TRADEMARK NO.	DATE OF PATENT OR TRADEMARK HOLDER OF PATENT OR TRADEMARK
1	
2	
3	
4	
5	

In the above—entitled case, the following decision has been rendered or judgement issued:

DECISION/JUDGEMENT
--------------------

CLERK Thomas G. Bruton	(BY) DEPUTY CLERK Amanda Scherer	DATE 3/16/2018
---------------------------	-------------------------------------	-------------------

Copy 1—Upon initiation of action, mail this copy to Director Copy 3—Upon termination of action, mail this copy to Director  
 Copy 2—Upon filing document adding patent(s), mail this copy to Director Copy 4—Case file copy

EWS-003324

UNITED STATES PATENT AND TRADEMARK OFFICE

---

BEFORE THE PATENT TRIAL AND APPEAL BOARD

---

ADOBE SYSTEMS INCORPORATED,  
Petitioner,

v.

WILLIAM GRECIA,  
Patent Owner.

---

Case IPR2018-00419  
Patent 8,533,860 B1

---

Before JAMESON LEE, MICHAEL W. KIM, and  
MICHELLE N. WORMMEESTER, *Administrative Patent Judges*.

WORMMEESTER, *Administrative Patent Judge*.

DECISION  
Denying Institution of *Inter Partes* Review  
35 U.S.C. § 314(a)

## I. INTRODUCTION

Adobe Systems Incorporated (“Petitioner”) filed a Petition (Paper 2, “Pet.”) requesting *inter partes* review of claims 9, 10, and 21–30 of U.S. Patent No. 8,533,860 B1 (Ex. 1001, “the ’860 patent”). William Grecia (“Patent Owner”) filed a Preliminary Response (Paper 6, “Prelim. Resp.”). We have jurisdiction under 35 U.S.C. § 314 and 37 C.F.R. § 42.4(a). Under 35 U.S.C. § 314(a), an *inter partes* review may not be instituted “unless . . . there is a reasonable likelihood that the petitioner would prevail with respect to at least 1 of the claims challenged in the petition.” For the reasons that follow, we decline to institute an *inter partes* review of the challenged claims.

## II. BACKGROUND

### A. Related Proceedings

The parties identify several federal district court cases relating to the ’860 patent. Pet. 2; Ex. 1011; Paper 4. The parties also identify several other petitions for *inter partes* review relating to the ’860 patent. Pet. 2–3; Paper 4.

### B. The ’860 Patent

The ’860 patent describes a digital rights management system, that manages access rights across a plurality of devices via digital media personalization, to protect digital media subject to illegal copying. Ex. 1001, 1:19–26; 4:47–48. Figure 3 of the ’860 patent, which illustrates how an example of such a system works, is reproduced below.



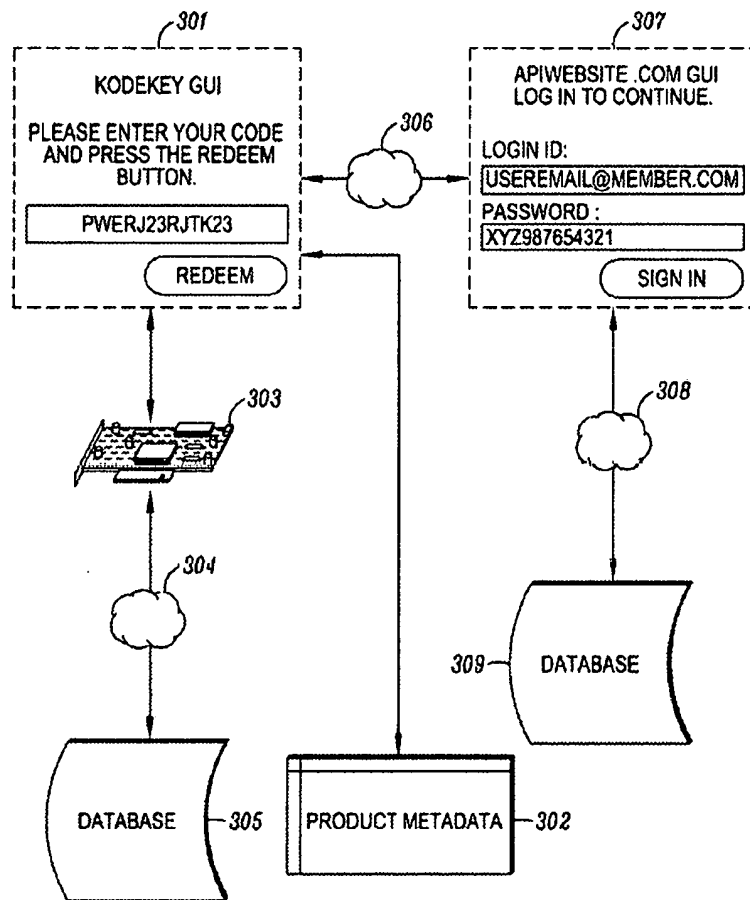

FIG. 3

In particular, Figure 3 provides a flow chart of a digital media personalization process. *Id.* at 4:23–25. A user who wishes to access certain digital media posts a branding request via Kodekey GUI 301, which prompts the user to enter a token and press the redeem button. *Id.* at 6:65–7:3. The branding request is a request to read or write metadata of the digital media, and includes a membership verification token corresponding to the digital media. *Id.* at 5:47–50. The token represents the digital media provider's permission to grant access rights. *Id.* at 9:20–21. Kodekey GUI 301 is connected to token database 305, which is used to authenticate the token. *Id.* at 7:6–7, 8:19–21. After authentication, the user is redirected to

APIwebsite.com GUI 307, which prompts the user to enter a login ID and password to access the digital media from database 309. *Id.* at 7:10–11, 14–17. The APIwebsite.com GUI interfaces to a web service membership (e.g., Facebook), where an electronic identification for the user is collected and sent to Kodekey GUI 301. *Id.* at 7:10–14, 10:41–44. Kodekey GUI 301 also is connected to product metadata 302, which is readable/writable metadata associated with the digital media to be acquired. *Id.* at 7:3–4. Product metadata 302 is branded by writing the token and the user’s electronic identification reference into the metadata. *Id.* at 8:27–30. For a subsequent access request, the user’s electronic identification reference is compared against the electronic identification reference in metadata 302. *Id.* at 13:53–57. If there is a match, access rights are granted to the user. *Id.* at 13:57–58.

### *C. Challenged Claims*

Petitioner challenges claims 9, 10, and 21–30 of the ’860 patent. Claims 9 and 21 are independent. Claim 9 is illustrative of the claims under challenge:

9. A system for authorizing access to digital content using a worldwide cloud system infrastructure, the worldwide cloud system infrastructure comprising connected modules in operation as computing and storage, the computing and storage comprising a server, a database, devices and users, wherein the digital content is at least one of encrypted or not encrypted, the system facilitating access rights between a plurality of data processing devices, the system working as a front-end agent for access rights authentication between the plurality of data processing devices, the system further comprising:

a first receipt module, the first receipt module receiving a digital content access request from at least one

communications console of the plurality of data processing devices, the access request being a read or write request of metadata of the digital content, wherein the read or write request of metadata is performed in connection with a combination of a device, the server, the database and the cloud system, the metadata further comprises one or more of a software or contents of a web page, the request comprising a verification token provided by a user corresponding to the digital content, wherein the verification token is one or more of a password, e-mail address, payment system, credit card, authorize ready device, rights token, or one or more redeemable instruments of trade;

- an authentication module, the authentication module authenticating the verification token;
- a connection module, the connection module establishing a connection with the at least one communications console, wherein the communications console is a combination of a graphic user interface (GUI) and an Application Programmable Interface (API) wherein the API is obtained from a verified web service, the web service capable of facilitating a two way data exchange to complete a verification process wherein the data exchange session comprises at least one identification reference;
- request module, the request module requesting the at least one identification reference from the at least one communications console, wherein the identification reference comprises one or more of a verified web service account identifier, letter, number, rights token, e-mail, password, access time, serial number, address, manufacturer identification, checksum, operating system version, browser version, credential, cookie, or key;
- a secondary receipt module, the secondary receipt module receiving the at least one identification reference from the at least one communications console; and

a branding module, the branding module writing at least one of the verification token or the identification reference into the metadata.

*D. Asserted Grounds of Unpatentability*

Petitioner challenges claims 9, 10, and 21–30 of the '860 patent on the following grounds. Pet. 1, 50–76.

References	Basis	Claims Challenged
Ameerally, <sup>1</sup> Gautier, <sup>2</sup> Frakes, <sup>3</sup> Zweig, <sup>4</sup> and Venkataramu <sup>5</sup>	§ 103	9 and 10
Ameerally, Gautier, Frakes, Zweig, Venkataramu, Suitts, <sup>6</sup> and Kondrk <sup>7</sup>	§ 103	21–30

In support of its arguments, Petitioner relies on a Declaration of Dr. Aviel Rubin (Ex. 1002), a Declaration of Amisha Manek (Ex. 1023), and an Affidavit of Christopher Butler (Ex. 1024).

---

<sup>1</sup> Ameerally, U.S. Publ'n No. 2006/0212401 A1, published Sept. 21, 2006 (Ex. 1004).

<sup>2</sup> Gautier, U.S. Publ'n No. 2005/0021478 A1, published Jan. 27, 2005 (Ex. 1005).

<sup>3</sup> Dan Frakes, *First Look: iTunes Digital Copy*, Macworld, <http://www.macworld.com/article/131751/2008/01/digitalcopy.html>, last visited Jan. 10, 2017 (Ex. 1006).

<sup>4</sup> Zweig, U.S. Publ'n No. 2007/0233606 A1, published Oct. 4, 2007 (Ex. 1008).

<sup>5</sup> Ramya Venkataramu, *Analysis and Enhancement of Apple's Fairplay Digital Rights Management* (May 2007) (Project Report, San Jose State University) (Ex. 1007).

<sup>6</sup> Suitts, U.S. Publ'n No. 2008/0040379 A1, published Feb. 14, 2008 (Ex. 1009).

<sup>7</sup> Kondrk, U.S. Publ'n No. 2004/0254883 A1, published Dec. 16, 2004 (Ex. 1010).

*E. Claim Construction*

We construe claims in an unexpired patent by applying the broadest reasonable interpretation in light of the specification of the patent in which they appear. *See* 37 C.F.R. § 42.100(b); *Cuozzo Speed Techs., LLC v. Lee*, 136 S. Ct. 2131, 2144–46 (2016) (upholding the use of the broadest reasonable interpretation standard). Under this standard, claim terms generally are given their ordinary and customary meaning, as would be understood by one of ordinary skill in the art in the context of the entire disclosure. *See In re Translogic Tech., Inc.*, 504 F.3d 1249, 1257 (Fed. Cir. 2007). A “claim term will not receive its ordinary meaning if the patentee acted as his own lexicographer,” however, and clearly set forth a definition of the claim term in the specification. *CCS Fitness, Inc. v. Brunswick Corp.*, 288 F.3d 1359, 1366 (Fed. Cir. 2002).

Petitioner argues proposed constructions for various limitations of the claims. Pet. 18–29. Patent Owner does not respond. *See generally* Prelim. Resp. For purposes of this Decision, we conclude that no claim term requires express interpretation at this time to resolve any controversy in this proceeding. *See Vivid Techs., Inc. v. Am. Sci. & Eng’g, Inc.*, 200 F.3d 795, 803 (Fed. Cir. 1999) (“[O]nly those terms need be construed that are in controversy, and only to the extent necessary to resolve the controversy.”).

III. ANALYSIS

Petitioner relies on Venkataramu as a printed publication for each of its asserted grounds. Pet. 1; *see also id.* at 24 (referring to Venkataramu as a “prior art publication[.]”); 37 C.F.R. §42.104(b)(2) (the petition “must identify . . . the patents or printed publications relied upon for each ground”).

Patent Owner contends that Petitioner has failed to establish that Venkataramu was publicly accessible before the “critical date”<sup>8</sup> for the ’860 patent, and that Petitioner has thus failed to establish that Venkataramu qualifies as a printed publication. Prelim. Resp. 2, 4–8.<sup>9</sup> For the reasons explained below, we agree with Patent Owner.

According to the Federal Circuit, “[b]ecause there are many ways in which a reference may be disseminated to the interested public, ‘public accessibility’ has been called the touchstone in determining whether a reference constitutes a ‘printed publication’” under Section 102. *Kyocera Wireless Corp. v. Int’l Trade Comm’n*, 545 F.3d 1340, 1350 (Fed. Cir. 2008) (quoting *In re Hall*, 781 F.2d 897, 898–99 (Fed. Cir. 1986)). A reference is publicly accessible “upon a satisfactory showing that such document has been disseminated or otherwise made available to the extent that persons interested and ordinarily skilled in the subject matter or art exercising reasonable diligence, can locate it.” *SRI Int’l, Inc. v. Internet Sec. Sys., Inc.*,

---

<sup>8</sup> The parties disagree as to the invention date to which Patent Owner is entitled for the challenged claims. The earliest possible effective filing date for the ’860 patent is March 21, 2010. Ex. 1001, 1:7–14. Petitioner asserts that it will assume for purposes of its Petition that the ’860 patent is entitled to an invention date of February 10, 2010. Pet. 10. Patent Owner asserts an invention date of March 21, 2009. Prelim. Resp. 4, 6. Because we find that Petitioner does not show sufficiently that Venkataramu was publicly accessible prior to the earliest possible effective filing date for the ’860 patent, as explained in this section, we need not evaluate further for purposes of this Decision the possibility of an earlier date of invention for the ’860 patent.

<sup>9</sup> Patent Owner did not number the pages in its Preliminary Response. For purposes of this Decision, we have assigned a page number, starting with 1, to each of the pages in the Preliminary Response, starting with the caption page. Thus, the caption page is considered to be at page 1.

511 F.3d 1186, 1194 (Fed. Cir. 2008). We assess public accessibility on a case-by-case basis. *See Kyocera*, 545 F.3d at 1350.

In instances of references stored in libraries, for example, “competent evidence of the general library practice may be relied upon to establish an approximate time when a thesis became accessible.” *In re Hall*, 781 F.2d at 899. “In these cases, we generally inquire whether the reference was sufficiently indexed or cataloged.” *Blue Calypso, LLC v. Groupon, Inc.*, 815 F.3d 1331, 1348 (Fed. Cir. 2016); *see also Medtronic, Inc. v. Barry*, --F.3d--, 2018 WL 2769092, at \*8 (Fed. Cir. Jun. 11, 2018) (“The issue of a reference’s public accessibility often arises in the context of references stored in libraries. In such cases, we generally inquire whether the reference was sufficiently indexed or cataloged.”); *accord Voter Verified, Inc. v. Premier Election Solutions, Inc.*, 698 F.3d 1374, 1380 (Fed. Cir. 2012) (“indexing is a relevant factor in determining accessibility of potential prior art, particularly library-based references”). In *Hall*, the Federal Circuit found sufficient “a declaration from the university librarian which detailed the library’s procedures for receiving, cataloging, and shelving of theses and attested to the relevant dates that [a certain] thesis was processed.” 781 F.2d at 899. By contrast, in *SRI International*, a document on an FTP server was not shown to have been sufficiently publicly available, in part, because “the FTP server did not contain an index or catalogue or other tools for customary and meaningful research.” 511 F.3d at 1196. In another example, theses deposited at a library “were not accessible to the public because they had not been either cataloged or indexed in a meaningful way.” *In re Cronyn*, 890 F.2d 1158, 1161 (Fed. Cir. 1989). In *Cronyn*, the theses were cataloged in alphabetical order, by title, and “the student’s name,

which, of course, bears no relationship to the subject of the student's thesis.”  
*Id.*

Here, Venkataramu states on its face that it is a “Project Report” presented to the faculty of the computer science department at San Jose State University (SJSU). Ex. 1007 (cover page). Petitioner alleges that Venkataramu “was available and indexed as a Masters’ Thesis by San Jose State University and made available on the University’s website at least as of October 2, 2008, as evidenced by its record in the Internet Archive.”

Pet. 36. As support, Petitioner relies on the Affidavit of Christopher Butler. *Id.* (citing Ex. 1024 ¶¶ 1, 4–5). According to his Affidavit, Mr. Butler is an office manager at the Internet Archive, which is located in San Francisco, California, rather than a staff member of the SJSU library where Petitioner alleges Venkataramu is located. Ex. 1024 ¶ 1. Mr. Butler testifies that the Internet Archive provides a service called the Wayback Machine, which allows users to access web pages stored in the Internet Archive’s web archive. *Id.* ¶ 3. The archived data is compiled using software programs that surf the web and automatically store copies of web files, preserving the files as they exist at the time of capture. *Id.* ¶ 4. The Internet Archive assigns a URL on its site to each archived file in the following format: [http://web.archive.org/web/\[yyyy\]\[mm\]\[dd\]\[hh:mm:ss\]/\[Archived URL\]](http://web.archive.org/web/[yyyy][mm][dd][hh:mm:ss]/[Archived URL]). *Id.* ¶ 5.

Attached to Mr. Butler’s Affidavit is an Exhibit A, which Mr. Butler testifies comprises “true and accurate copies of printouts of the Internet Archive’s records of the HTML files or PDF files for the URLs and the dates specified in the footer of the printout (HTML) or attached coversheet (PDF).” *Id.* ¶ 6, Ex. A. We note that Exhibit A includes a cover sheet, as



well as what appears to be a copy of Venkataramu. *Id.*, Ex. A. The cover sheet displays the following URL:

[https://web.archive.org/web/20081002140457/http://www.cs.sjsu.edu/faculty/stamp/students/RamyaVenkataramu\\_CS298Report.pdf](https://web.archive.org/web/20081002140457/http://www.cs.sjsu.edu/faculty/stamp/students/RamyaVenkataramu_CS298Report.pdf). *Id.* Thus, according to Mr. Butler, the Internet Archive captured and archived a copy of Venkataramu on October 2, 2008, at 2:04 pm.

Patent Owner responds that Petitioner provides “no evidence in the record regarding the San Jose State University website.” Prelim. Resp. 6. As such, Patent Owner argues that Petitioner “failed to produce evidence sufficient to show that the *Venkataramu* Report was publicly accessible before the critical date” for the ’860 patent, and that Venkataramu therefore “does not qualify as prior art.” *Id.*

We agree with Patent Owner. To determine a date on which Venkataramu was publicly accessible, we look to evidence of the SJSU library’s cataloging and indexing practices, as well as any search capability of the library’s website. *See Blue Calypso*, 815 F.3d at 1348; *Voter Verified*, 698 F.3d at 1380; *SRI*, 511 F.3d at 1196. Neither Petitioner nor Mr. Butler offers sufficient evidence that Venkataramu was sufficiently indexed or catalogued at SJSU for access. That the Internet Archive *captured* and *archived* a copy of Venkataramu does not mean, by itself, that Venkataramu was sufficiently indexed or catalogued at SJSU. Nor does it reveal anything about the search capabilities of the SJSU library website. Mr. Butler does not claim to have personal knowledge of the general library practices of the SJSU library, or the search capabilities of the SJSU library website. For example, he does not testify as to the procedures, if any, the university uses to index or catalog project reports, or the manner, if at all, in which project

reports are indexed or cataloged (e.g., by author, title, subject). He also does not testify as to the search capabilities of the SJSU library website. Further, neither Petitioner nor Mr. Butler introduces any evidence that Venkataramu was actually disseminated to any interested skilled artisans prior to the earliest possible effective filing date for the '860 patent. Additionally, Petitioner has not explained why making a copy of Venkataramu accessible on the Internet Archive constitutes publication of Venkataramu on the Internet Archive as of October 2, 2008. In that regard, we note that Mr. Butler's Affidavit does not indicate that the archived files are searchable through a subject matter index or catalog.

We note Petitioner's additional assertion in a footnote that "[f]urther evidence of public availability of *Venkataramu* before the priority date of the '860 Patent is the book chapter authored by Ramya Venkataramu for the book 'Handbook of Research on Secure Multimedia Distribution,' published on February 26, 2009, which provides a citation to the same internet address archived above." Pet. 36–37 n.4. To support that assertion, Petitioner directs us to where the book cites the internet address for Venkataramu. *Id.* (citing Ex. 1015, 155). Petitioner also directs us to a Library of Congress record that provides some information about the book. *Id.* (citing Ex. 1022). Petitioner relies on the Declaration of Amisha Manek, an attorney at Perkins Coie, LLP. *Id.* (citing Ex. 1023 ¶¶ 2–3); Ex. 1023 ¶ 1. In her Declaration, Ms. Manek observes that both the title page of the book and the first page of the book chapter (which cites the internet address for Venkataramu) have a 2009 copyright date, and that the Library of Congress record shows that the book was "published or created" in 2009. Ex. 1023 ¶ 2 (citing Ex. 1015 (title page)); *id.* ¶ 3 (citing Ex. 1022).

In response, Patent Owner counters that Petitioner “fail[s] to produce evidence sufficient to show that the *Venkataramu* Report, as cited in the [book], was publicly accessible before the critical date.” Prelim. Resp. 8. We agree. Neither Petitioner nor Ms. Manek explains the relationship, if any, between the book and Venkataramu. For example, Petitioner does not explain, and Ms. Manek does not testify, as to how a member of the public interested in the subject matter of Venkataramu would have located it by first obtaining access to the book.

In view of the foregoing, we determine that Petitioner has not shown sufficiently that Venkataramu was publicly accessible prior to the earliest possible effective filing date for the '860 patent. Therefore, Petitioner has not shown that Venkataramu qualifies as a printed publication. Because each of Petitioner's asserted grounds relies on Venkataramu, Petitioner has not demonstrated a reasonable likelihood of showing that any of claims 9, 10, and 21–30 of the '860 patent would have been obvious over any of the asserted grounds.

#### IV. CONCLUSION

For the foregoing reasons, Petitioner has not demonstrated on the record before us a reasonable likelihood that it would prevail in showing the unpatentability of any challenged claim of the '860 patent.

#### V. ORDER

For the reasons given, it is

ORDERED that the Petition is *denied* and no trial is instituted.

IPR2018-00419  
Patent 8,533,860 B1

PETITIONER:

James F. Valentine  
Matthew J. Moffa  
PERKINS COIE LLP  
jvalentine@perkinscoie.com  
mmoffa@perkinscoie.com

PATENT OWNER:

Isaac Rabicoff  
Kenneth Matuszewski  
RABICOFF LAW LLC  
isaac@rabilaw.com  
kenneth@rabilaw.com

AO 120 (Rev. 08/10)

<b>TO: Mail Stop 8 Director of the U.S. Patent and Trademark Office P.O. Box 1450 Alexandria, VA 22313-1450</b>	<b>REPORT ON THE FILING OR DETERMINATION OF AN ACTION REGARDING A PATENT OR TRADEMARK</b>
---	---

In Compliance with 35 U.S.C. § 290 and/or 15 U.S.C. § 1116 you are hereby advised that a court action has been filed in the U.S. District Court Northern District of Illinois on the following

Trademarks or  Patents. (  the patent action involves 35 U.S.C. § 292.):

DOCKET NO. 18-cv-1884	DATE FILED	U.S. DISTRICT COURT Northern District of Illinois
PLAINTIFF William Grecia		DEFENDANT ALDI, Inc.
PATENT OR TRADEMARK NO.	DATE OF PATENT OR TRADEMARK	HOLDER OF PATENT OR TRADEMARK
1 US 8,533,860 B1	9/10/2013	William Grecia
2		
3		
4		
5		

In the above—entitled case, the following patent(s)/ trademark(s) have been included:

DATE INCLUDED	INCLUDED BY <input type="checkbox"/> Amendment <input type="checkbox"/> Answer <input type="checkbox"/> Cross Bill <input type="checkbox"/> Other Pleading	
PATENT OR TRADEMARK NO.	DATE OF PATENT OR TRADEMARK	HOLDER OF PATENT OR TRADEMARK
1		
2		
3		
4		
5		

In the above—entitled case, the following decision has been rendered or judgement issued:

DECISION/JUDGEMENT
--------------------

CLERK Thomas G. Bruton	(BY) DEPUTY CLERK L. Fairley	DATE 3/16/2018
---------------------------	---------------------------------	-------------------

Copy 1—Upon initiation of action, mail this copy to Director Copy 3—Upon termination of action, mail this copy to Director  
Copy 2—Upon filing document adding patent(s), mail this copy to Director Copy 4—Case file copy

EWS-003339

AO 120 (Rev. 08/10)

<b>TO:</b> <b>Mail Stop 8</b> <b>Director of the U.S. Patent and Trademark Office</b> <b>P.O. Box 1450</b> <b>Alexandria, VA 22313-1450</b>	<b>REPORT ON THE</b> <b>FILING OR DETERMINATION OF AN</b> <b>ACTION REGARDING A PATENT OR</b> <b>TRADEMARK</b>
--	---

In Compliance with 35 U.S.C. § 290 and/or 15 U.S.C. § 1116 you are hereby advised that a court action has been filed in the U.S. District Court Northern District of Illinois on the following

Trademarks or  Patents. (  the patent action involves 35 U.S.C. § 292.):

DOCKET NO. 1:18-cv-1886	DATE FILED 3/15/2018	U.S. DISTRICT COURT Northern District of Illinois
PLAINTIFF William Grecia		DEFENDANT True Value Company
PATENT OR TRADEMARK NO.	DATE OF PATENT OR TRADEMARK	HOLDER OF PATENT OR TRADEMARK
1 8,533,860	9/10/2013	Grecia
2		
3		
4		
5		

In the above—entitled case, the following patent(s)/ trademark(s) have been included:

DATE INCLUDED	INCLUDED BY <input type="checkbox"/> Amendment <input type="checkbox"/> Answer <input type="checkbox"/> Cross Bill <input type="checkbox"/> Other Pleading	
PATENT OR TRADEMARK NO.	DATE OF PATENT OR TRADEMARK	HOLDER OF PATENT OR TRADEMARK
1		
2		
3		
4		
5		

In the above—entitled case, the following decision has been rendered or judgement issued:

DECISION/JUDGEMENT
--------------------

CLERK Thomas G. Bruton	(BY) DEPUTY CLERK Amanda Scherer	DATE 3/16/2018
---------------------------	-------------------------------------	-------------------

Copy 1—Upon initiation of action, mail this copy to Director Copy 3—Upon termination of action, mail this copy to Director  
 Copy 2—Upon filing document adding patent(s), mail this copy to Director Copy 4—Case file copy

EWS-003340

AO 120 (Rev. 08/10)

<b>TO:</b> <b>Mail Stop 8</b> <b>Director of the U.S. Patent and Trademark Office</b> <b>P.O. Box 1450</b> <b>Alexandria, VA 22313-1450</b>	<b>REPORT ON THE</b> <b>FILING OR DETERMINATION OF AN</b> <b>ACTION REGARDING A PATENT OR</b> <b>TRADEMARK</b>
--	---

In Compliance with 35 U.S.C. § 290 and/or 15 U.S.C. § 1116 you are hereby advised that a court action has been filed in the U.S. District Court \_\_\_\_\_ for the Southern District of New York \_\_\_\_\_ on the following

Trademarks or  Patents. (  the patent action involves 35 U.S.C. § 292.);

DOCKET NO. 1:15-cv-9210	DATE FILED 11/23/2015	U.S. DISTRICT COURT for the Southern District of New York
PLAINTIFF William Grecia		DEFENDANT Visa Inc.
PATENT OR TRADEMARK NO.	DATE OF PATENT OR TRADEMARK	HOLDER OF PATENT OR TRADEMARK
1 8,887,308	11/11/2014	William Grecia
2 8,533,860	9/10/2013	William Grecia
3 8,402,555	3/19/2013	William Grecia
4		
5		

In the above—entitled case, the following patent(s)/ trademark(s) have been included:

DATE INCLUDED	INCLUDED BY <input type="checkbox"/> Amendment <input type="checkbox"/> Answer <input type="checkbox"/> Cross Bill <input type="checkbox"/> Other Pleading	
PATENT OR TRADEMARK NO.	DATE OF PATENT OR TRADEMARK	HOLDER OF PATENT OR TRADEMARK
1		
2		
3		
4		
5		

In the above—entitled case, the following decision has been rendered or judgement issued:

DECISION/JUDGEMENT
--------------------

CLERK Ruby J. Krajick	(BY) DEPUTY CLERK /s/ P. Canales	DATE 11/24/2015
--------------------------	-------------------------------------	--------------------

Copy 1—Upon initiation of action, mail this copy to Director Copy 3—Upon termination of action, mail this copy to Director  
 Copy 2—Upon filing document adding patent(s), mail this copy to Director Copy 4—Case file copy

EWS-003341

AO 120 (Rev. 08/10)

TO: <b>Mail Stop 8</b> <b>Director of the U.S. Patent and Trademark Office</b> <b>P.O. Box 1450</b> <b>Alexandria, VA 22313-1450</b>	<b>REPORT ON THE</b> <b>FILING OR DETERMINATION OF AN</b> <b>ACTION REGARDING A PATENT OR</b> <b>TRADEMARK</b>
---	---

In Compliance with 35 U.S.C. § 290 and/or 15 U.S.C. § 1116 you are hereby advised that a court action has been filed in the U.S. District Court \_\_\_\_\_ on the following

Trademarks or  Patents. (  the patent action involves 35 U.S.C. § 292.);

DOCKET NO. 1:16-cv-7024	DATE FILED 9/8/2016	U.S. DISTRICT COURT
PLAINTIFF WILLIAM GRECIA		DEFENDANT BESTBUY.COM, LLC
PATENT OR TRADEMARK NO.	DATE OF PATENT OR TRADEMARK	HOLDER OF PATENT OR TRADEMARK
1 8,533,860	9/10/2013	WILLIAM GRECIA
2		
3		
4		
5		

In the above—entitled case, the following patent(s)/ trademark(s) have been included:

DATE INCLUDED	INCLUDED BY		
	<input checked="" type="radio"/> Amendment <input checked="" type="radio"/> Answer <input checked="" type="radio"/> Cross Bill <input checked="" type="radio"/> Other Pleading		
TRADEMARK NO.	DATE OF PATENT OR TRADEMARK	HOLDER OF PATENT OR TRADEMARK	
1			
2			
3			
4			
5			

In the above—entitled case, the following decision has been rendered or judgement issued:

DECISION/JUDGEMENT
--------------------

CLERK	(BY) DEPUTY CLERK	DATE
-------	-------------------	------

Copy 1—Upon initiation of action, mail this copy to Director    Copy 3—Upon termination of action, mail this copy to Director  
 Copy 2—Upon filing document adding patent(s), mail this copy to Director    Copy 4—Case file copy



AO 120 (Rev. 08/10)

<b>TO: Mail Stop 8</b> <b>Director of the U.S. Patent and Trademark Office</b> <b>P.O. Box 1450</b> <b>Alexandria, VA 22313-1450</b>	<b>REPORT ON THE</b> <b>FILING OR DETERMINATION OF AN</b> <b>ACTION REGARDING A PATENT OR</b> <b>TRADEMARK</b>
---	---

In Compliance with 35 U.S.C. § 290 and/or 15 U.S.C. § 1116 you are hereby advised that a court action has been filed in the U.S. District Court Northern District of Illinois on the following

Trademarks or  Patents. (  the patent action involves 35 U.S.C. § 292.):

DOCKET NO. 17cv7300	DATE FILED 10/10/2017	U.S. DISTRICT COURT Northern District of Illinois
PLAINTIFF William Grecia		DEFENDANT Discover Financial Services, Inc.
PATENT OR TRADEMARK NO.	DATE OF PATENT OR TRADEMARK	HOLDER OF PATENT OR TRADEMARK
1 8,887,308 B2	11/11/2014	William Grecia
2 8,533,860 B1	9/10/2013	William Grecia
3 8,402,555 B2	3/19/2013	William Grecia
4		
5		

In the above—entitled case, the following patent(s)/ trademark(s) have been included:

DATE INCLUDED	INCLUDED BY <input type="checkbox"/> Amendment <input type="checkbox"/> Answer <input type="checkbox"/> Cross Bill <input type="checkbox"/> Other Pleading	
PATENT OR TRADEMARK NO.	DATE OF PATENT OR TRADEMARK	HOLDER OF PATENT OR TRADEMARK
1		
2		
3		
4		
5		

In the above—entitled case, the following decision has been rendered or judgement issued:

DECISION/JUDGEMENT
--------------------

CLERK Thomas G. Bruton	(BY) DEPUTY CLERK Anya Ellis	DATE 10/11/2017
---------------------------	---------------------------------	--------------------

Copy 1—Upon initiation of action, mail this copy to Director Copy 3—Upon termination of action, mail this copy to Director  
 Copy 2—Upon filing document adding patent(s), mail this copy to Director Copy 4—Case file copy

EWS-003343

(12) **INTER PARTES REVIEW CERTIFICATE** (256th)

**United States Patent  
Grecia**

(10) **Number:** US **8,533,860 K1**  
(45) **Certificate Issued:** Jan. 11, 2018

---

(54) **PERSONALIZED DIGITAL MEDIA ACCESS  
SYSTEM—PDMAS PART II**

(71) Applicant: **William Grecia**

(72) Inventor: **William Grecia**

**Trial Number:**

IPR2017-00791 filed Jan. 27, 2017

**Petitioner:** Mastercard International Incorporated

**Patent Owner:** William Grecia

**Inter Partes Review Certificate for:**

Patent No.: **8,533,860**  
Issued: **Sep. 10, 2013**  
Appl. No.: **13/740,086**  
Filed: **Jan. 11, 2013**

The results of IPR2017-00791 are reflected in this inter partes review certificate under 35 U.S.C. 318(b).

**INTER PARTES REVIEW CERTIFICATE**  
**U.S. Patent 8,533,860 K1**  
**Trial No. IPR2017-00791**  
**Certificate Issued Jan. 11, 2018**

**1**

**2**

AS A RESULT OF THE INTER PARTES  
REVIEW PROCEEDING, IT HAS BEEN  
DETERMINED THAT:

Claims 1-8 and 11-20 are cancelled.

5

\* \* \* \* \*

UNITED STATES PATENT AND TRADEMARK OFFICE

---

BEFORE THE PATENT TRIAL AND APPEAL BOARD

---

MASTERCARD INTERNATIONAL INCORPORATED,  
Petitioner,

v.

WILLIAM GRECIA,  
Patent Owner.

---

Cases IPR2017-00791  
Patent 8,533,860 B1

---

Before JAMESON LEE, MICHAEL W. KIM, and  
MICHELLE N. WORMMEESTER, *Administrative Patent Judges.*

KIM, *Administrative Patent Judge.*

JUDGMENT

37 C.F.R. § 42.73(b)

On January 27, 2017, Mastercard International Incorporated, (“Petitioner”) filed a Petition (Paper 2) requesting *inter partes* review of claims 1–30 of U.S. Patent No. 8,533,860 B1 (Ex. 1001, “the ’860 patent”). On July 5, 2017, we instituted trial in a Decision with respect to claims 1–8 and 11–20 of the ’860 patent. Paper 7, 49.

On September 18, 2017, William Grecia (“Patent Owner”) contacted the Board to request authorization to file a Motion to Request Adverse Judgment (“Motion”) on all instituted claims 1–8 and 11–20. With the request, Patent Owner also included the instant Motion. The Board grants the request, and for the purposes of expediency, we enter *sua sponte* the included Motion into the record, and consider the Motion at this time.

Under 37 C.F.R. § 42.73(b)(2), a party may request judgment against itself at any time during a proceeding, and cancellation or disclaimer of a claim such that the party has no remaining claim in the trial is an action construed to be a request for entry of adverse judgment. In the circumstances of this case, the filing of a “motion” is not necessary. Patent Owner simply could have filed a request for adverse judgment. The Motion states “Patent Owner respectfully requests judgment against itself as to the claims remaining in this proceeding and asks that the Board cancel claims 1–8 and 11–20.” Motion 1–2. Accordingly, on these facts, we treat the Motion as a request for adverse judgment.

It is

ORDERED that Patent Owner’s Motion is *granted* and the Motion is entered into the record;

FURTHER ORDERED that the request is *granted* and adverse judgment is entered against Patent Owner;

IPR2017-00791  
Patent 8,533,860 B1

FURTHER ORDERED that claims 1–8 and 11–20 of U.S. Patent No. 8,533,860 B1 be cancelled; and

FURTHER ORDERED that the *inter partes* review captioned IPR2017-00791 is terminated.

IPR2017-00791  
Patent 8,533,860 B1

PETITIONER:

Joseph R. Lanser  
Brian Michaelis  
David A. Klein  
Joseph Walker  
SEYFARTH SHAW LLP  
[jlanser@seyfarth.com](mailto:jlanser@seyfarth.com)  
[bmichaelis@seyfarth.com](mailto:bmichaelis@seyfarth.com)  
[daklein@seyfarth.com](mailto:daklein@seyfarth.com)  
[jmwalker@seyfarth.com](mailto:jmwalker@seyfarth.com)

PATENT OWNER:

Isaac Rabicoff  
RABICOFF LAW LLC  
[isaac@rabilaw.com](mailto:isaac@rabilaw.com)

AO 120 (Rev. 08/10)

<b>TO: Mail Stop 8</b> <b>Director of the U.S. Patent and Trademark Office</b> <b>P.O. Box 1450</b> <b>Alexandria, VA 22313-1450</b>	<b>REPORT ON THE</b> <b>FILING OR DETERMINATION OF AN</b> <b>ACTION REGARDING A PATENT OR</b> <b>TRADEMARK</b>
---	---

In Compliance with 35 U.S.C. § 290 and/or 15 U.S.C. § 1116 you are hereby advised that a court action has been filed in the U.S. District Court Northern District of Georgia on the following

Trademarks or  Patents. (  the patent action involves 35 U.S.C. § 292.):

DOCKET NO. 1:16-cv-1324-WSD	DATE FILED 4/22/2016	U.S. DISTRICT COURT Northern District of Georgia
PLAINTIFF William Grecia		DEFENDANT Cox Communications, Inc.
PATENT OR TRADEMARK NO.	DATE OF PATENT OR TRADEMARK	HOLDER OF PATENT OR TRADEMARK
1 US 8,533,860 B1	9/10/2013	William Grecia
2 US 8,402,555 B2	3/19/2013	
3		
4		
5		

In the above—entitled case, the following patent(s)/ trademark(s) have been included:

DATE INCLUDED	INCLUDED BY <input type="checkbox"/> Amendment <input type="checkbox"/> Answer <input type="checkbox"/> Cross Bill <input type="checkbox"/> Other Pleading	
PATENT OR TRADEMARK NO.	DATE OF PATENT OR TRADEMARK	HOLDER OF PATENT OR TRADEMARK
1		
2		
3		
4		
5		

In the above—entitled case, the following decision has been rendered or judgement issued:

DECISION/JUDGEMENT
--------------------

CLERK JAMES N. HATTEN	(BY) DEPUTY CLERK s/Rebecca Spratt	DATE 4/25/2016
--------------------------	---------------------------------------	-------------------

Copy 1—Upon initiation of action, mail this copy to Director Copy 3—Upon termination of action, mail this copy to Director  
 Copy 2—Upon filing document adding patent(s), mail this copy to Director Copy 4—Case file copy

EWS-003350





UNITED STATES PATENT AND TRADEMARK OFFICE

---

BEFORE THE PATENT TRIAL AND APPEAL BOARD

---

MASTERCARD INTERNATIONAL INCORPORATED,  
Petitioner,

v.

WILLIAM GRECIA,  
Patent Owner.

---

Case IPR2017-00791  
Patent 8,533,860 B1

---

Before JAMESON LEE, MICHAEL W. KIM, and  
MICHELLE N. WORMMEESTER, *Administrative Patent Judges*.

LEE, *Administrative Patent Judge*.

DECISION  
Institution of *Inter Partes* Review  
35 U.S.C. § 314(a) and 37 C.F.R. § 42.108

## I. INTRODUCTION

### A. Background and Summary

On January 27, 2017, Petitioner<sup>1</sup> filed a Petition (Paper 2, “Pet.”) to institute *inter partes* review of claims 1–30 of U.S. Patent No. 8,533,860 B1 (Ex. 1001, “the ’860 patent”). On May 22, 2017, Patent Owner<sup>2</sup> filed a Preliminary Response (Paper 6, “Prelim. Resp.”). To institute an *inter partes* review, we must determine that the information presented in the Petition shows “that there is a reasonable likelihood that the petitioner would prevail with respect to at least 1 of the claims challenged in the petition.” 35 U.S.C. § 314(a). Having considered the arguments and evidence presented by Petitioner and Patent Owner’s Preliminary Response, we determine that Petitioner has *not* shown a reasonable likelihood that it would prevail in establishing the unpatentability of any one of claims 9, 10, and 21–30 of the ’860 patent. However, Petitioner has shown a reasonable likelihood that it would prevail in establishing the unpatentability of claims 1–8 and 11–20 of the ’860 patent.

### B. Related Matters

Patent Owner has identified the following actions as related to the ’860 patent: (1) *Grecia v. DISH Network L.L.C.*, Case No. 4:16-cv-588 (N.D. Cal.) (February 3, 2016); (2) *Grecia v. MasterCard Incorporated*, Case No. 1:15-cv-9059 (S.D.N.Y.) (November 18, 2015); (3) *Grecia v. American Express Company*, Case No. 1:15-cv-9217 (S.D.N.Y.) (November 23, 2015); (4) *Grecia v. Visa Inc.*, Case No. 1:15-cv-9210

---

<sup>1</sup> MasterCard International Incorporated.

<sup>2</sup> William Grecia.

IPR2017-00791  
Patent 8,533,860 B1

(S.D.N.Y.) (February 23, 2015); (5) *Grecia v. McDonald's Corporation*, Case No. 1:16-cv-2560 (N.D. Ill.) (February 24, 2016). Paper 5. The '860 patent also is the subject of IPR2015-00422 and IPR2016-00600.<sup>3</sup> *Id.* Related Patent No. 8,887,308 B2 is the subject of IPR2016-00602, IPR2016-01519, IPR2017-00793, and IPR2017-00797.<sup>4</sup> *Id.*, Pet. 2. Related Patent 8,402,555 B2 is the subject of IPR2016-00789, IPR2017-00788, and IPR2017-00799.<sup>5</sup> *Id.*

### C. The '860 Patent

The '860 patent relates to a “more personal” system of digital rights management which employs electronic ID, as part of a web service membership, to manage access rights across a plurality of devices. Ex. 1001, 1:22–26. The disclosure is directed to “an apparatus that facilitates access to a data source to accept verification and authentication from an enabler using at least one token and at least one reference.” Ex. 1001, Abstr. “The at least one reference could be a device serial number, a networking MAC address, or a membership ID reference from a web service.” *Id.* According to the '860 patent, an “excelsior enabler” is a content acquirer, and “secondary enablers” are recognized friends and family of the excelsior enabler. *Id.* at 5:7–12. The excelsior enabler and secondary enablers are “human beings or computerized mechanisms programmed to process the

---

<sup>3</sup> IPR2015-00422 was terminated based on settlement. The Board declined to institute review in IPR2016-00600.

<sup>4</sup> The Board declined to institute review in IPR2016-00602 and in IPR2016-01519. IPR2017-00797 terminated by settlement.

<sup>5</sup> The Board declined to institute review in IPR2016-00789. IPR2017-00799 terminated by settlement.

steps of the invention as would normally be done manually by a human being.” *Id.* at 5:12–16.

The specification states:

[T]he current states of DRM measures are not satisfactory because unavoidable issues can arise such as hardware failure or property theft that could lead to a paying customer [losing] the right to recover purchased products. The current metadata writable DRM measures do not offer a way to provide unlimited interoperability between different machines. Therefore, a solution is needed to give consumers the unlimited interoperability between devices and “fair use” sharing partners for an infinite time frame while protecting commercial digital media from unlicensed distribution to sustain long-term return of investments.

*Id.* at 2:63–3:7.

Claims 1, 9, 11, and 21 are independent. Claim 1 is drawn to a method comprising certain steps for authorizing access to digital content using a cloud system having connected modules in operation as one or more computing or storage units, which method facilitates access rights between a plurality of data processing devices (*id.* at 14:31–15:4). Claim 9 is drawn to a system for authorizing access to digital content using a worldwide cloud system architecture comprising various modules that perform certain steps (*id.* at 15:45–16:28). Claim 11 is drawn to a non-transitory computer medium comprising program code that performs certain steps (*id.* at 16:41–17:14). Claim 21 is drawn to a computer product configured to perform certain steps and further requires a customization module (*id.* at 17:52–18:33).

Claim 9 further defines a worldwide cloud system infrastructure comprising connected modules in operation as computing and storage units including a server, a database, other devices, and users. *Id.* at 15:46–49. For

claim 9, the actions performed by the various modules, essentially, are the respective steps recited in method claim 1. For instance, claim 1 recites “authenticating the verification token,” and claim 9 recites “an authentication module, the authentication module authenticating the verification token.” *Id.* at 14:50, 16:4–5.

Claim 11 further specifies in its preamble that the program code is a part of an operating system software or downloaded in sections from a web server. *Id.* at 16:42–43. The various steps performed by the program code of claim 11 are, essentially, the same as the steps performed by the method of claim 1, except that while claim 1 recites that the read or write request of metadata is performed in connection with a combination of at least one device and the cloud system, claim 11 recites that the read or write request of metadata is performed in connection with a combination of the operating system software program and a cloud system.

Claim 21 further specifies that the computer product comprises a memory, a CPU, a communications console and a non-transitory computer usable medium, wherein the computer usable medium stores an operating system. *Id.* at 17:52–55. Claim 21 also further specifies that the computer product comprises a customization module, and that the digital content is at least one of an application, a video, and a video game. *Id.* at 17:55–58.

The various steps performed by the computer product of claim 21 are, essentially, the same as the steps performed by the method of claim 1, except (1) that claim 21 does not require the read or write request of metadata of digital content to be performed in connection with a combination of any device and cloud system, (2) that claim 21 expressly requires the metadata to be “one or more of a database or storage in connection to the computer

product,”<sup>6</sup> (3) that claim 21 requires the verification token to be handled by a user as a redeemable instrument, and (4) that claim 21 provides a different list of items than those in claim 1, that may constitute the verification token, i.e., “at least one of a purchase permission, a rental permission, or a membership permission, wherein the at least one of purchase permission, rental permission, or membership permission being represented by one or more of a tag, a letter, a number, a combination of letters and numbers, a successful payment, a rights token, a phrase, a name, a membership credential, an image, a logo, a service name, an authorization, a list, an interface button, a downloadable program, or the redeemable instrument.”  
*Id.* at 17:52–18:33.

We focus on claim 1, which is representative and reproduced below:

1. A method for authorizing access to digital content using a cloud system, the cloud system comprising connected modules in operation as one or more of a cloud computing or a cloud storage in connection with devices and users, wherein the digital content is at least one of encrypted or not encrypted, the method facilitating access rights between a plurality of data processing devices, the method comprising:

receiving a digital content access request from at least one communications console of the plurality of data processing devices, the access request being a read or write request of metadata of the digital content, wherein the read or write request of metadata is performed in connection with a combination of at least one device and the cloud system, the request comprising a verification token provided by a first user corresponding to the digital content, wherein the verification token is one or more of a password, e-mail

---

<sup>6</sup> We understand the language as specifying that the metadata of the digital content is “in” one or more of a database or storage in connection to the computer product.

address, payment system, credit card, authorize ready device, rights token, or one or more redeemable instruments of trade;  
authenticating the verification token;  
establishing connection with the at least one communication console wherein the communication console is a combination of a graphical user interface (GUI) and an Application Programmable Interface (API) wherein the API is obtained from a verified web service, the web service capable of facilitating a two way data exchange [session] to complete a verification process wherein the data exchange session comprises at least one identification reference;  
requesting at least one identification reference from the at least one communications console, wherein the identification reference comprises one or more of a verified web service account identifier, letter, number, rights token, e-mail, password, access time, serial number, address, manufacturer identification, checksum, operating system version, browser version, credential, cookie, or key;  
receiving the at least one identification reference from the at least one communications console; and  
writing at least one of the verification token or the [identification] reference into the metadata.

Ex. 1001, 14:31–15:4.<sup>7</sup> The six steps of claim 1 are illustrated in a flowchart shown in Figure 6 of the '860 patent, reproduced below:

---

<sup>7</sup> Bracketed text reflect changes made by a Certificate of Correction, November 12, 2013, which is provided as an attachment to Exhibit 1001.

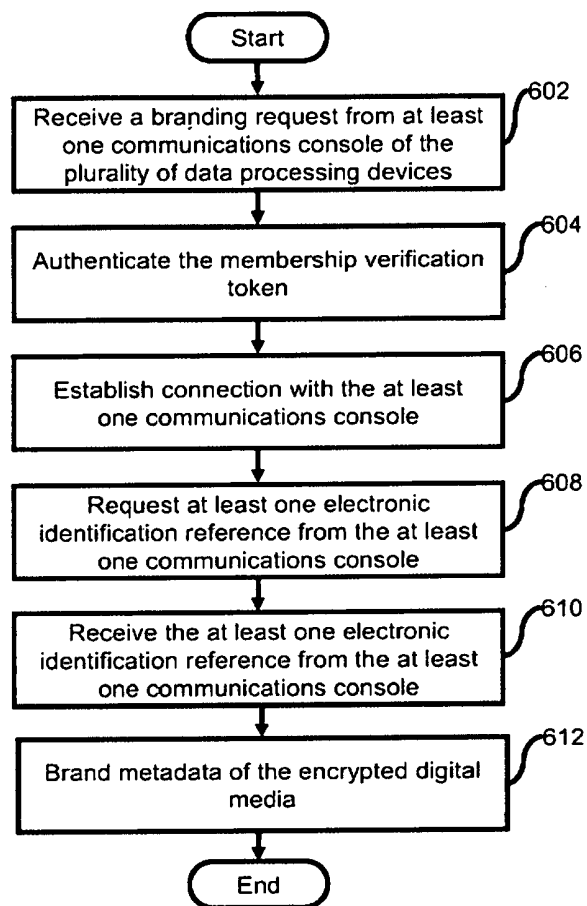

FIG.6

Figure 6 shows a flowchart of the process for monitoring access to an encrypted digital media, according to an embodiment of the '860 patent. *Id.* at 4:32–34.

D. Evidence Relied Upon by Petitioner

Petitioner relies on the following references:<sup>8</sup>

---

<sup>8</sup> The earliest possible effective filing date of the '860 patent that potentially may be established by Patent Owner is March 21, 2010. Ex. 1001, 1:7–14.



	<b>Reference</b>	<b>Date</b>	<b>Exhibit</b>
Ameerally	U.S. Pub. App. 2006/0212401 A1	Sept. 21, 2006	Ex. 1003
Zweig	U.S. Pub. App. 2007/0233606 A1	Oct. 4, 2007	Ex. 1004
iPod User Guide	<i>iPod touch User Guide</i> , Apple Inc., 2008	2008	Ex. 1005
Miller	Rich Miller, <i>Apple Moving Quickly on NC Project</i> , Data Center Knowledge	July 28, 2009	Ex. 1006
Frakes	Dan Frakes, <i>First Look: iTunes Digital Copy</i> , MacWorld, <a href="http://www.macworld.com/article/131751/2008/01/digital-copy.html">http://www.macworld.com/ article/131751/2008/01/digital copy.html</a> , last visited Jan. 10, 2017	Jan. 22, 2008	Ex. 1008
Taylor	David Taylor, <i>How Do I Use a Starbucks iTunes Free Pick of the Week Song Card</i> , <a href="http://wcb.archive.org/web/20080916071909/http://www.askdavetaylor.com/how_to_use_redeem_starbucks_itunes_free_pick_week_song_card.html">http://wcb.archive.org/web/ 20080916071909/ http://www.askdavetaylor.com/ how_to_use_redeem_starbucks itunes_free_pick_week_song_ card.html</a> (last visited Jan. 10, 2017)	August 8, 2008	Ex. 1009
iTunes® Terms	<i>iTunes Store Terms of Service</i> , Apple Inc.	Sept. 10, 2007	Ex. 1010
Gautier	U.S. Pub. App. 2005/0021478 A1	Jan. 27, 2005	Ex. 1011
Anderson	Ross Anderson, <i>Security Engineering: A Guide to Building Dependable Distributed Systems</i> , 2 <sup>nd</sup> Ed., Wiley Publishing, Inc., Chapter 22.	2008	Ex. 1012

Reference		Date	Exhibit
Christman	Ed Christman, <i>Brick-and-Mortar Stores Eye New Music Formats</i> , Reuters Internet News, <a href="http://www.reuters.com/article/us-formats-idUSN2838542620071028?pageNumber=1">http://www.reuters.com/article/us-formats-idUSN2838542620071028?pageNumber=1</a> (last visited: Jan. 13, 2017)	Oct. 28, 2007	Ex. 1013
iMac User Guide	iMac User Guide, Apple Inc.	2008	Ex. 1016
Suitts	U.S. Pub. App. 2008/0040379 A1	Feb. 14, 2008	Ex. 1017
Kondrk	U.S. Pub. App. 2004/0254883 A1	Dec. 16, 2004	Ex. 1018

Petitioner also relies on the Declaration of Ravi S. Cherukuri.

Ex. 1019.

E. The Asserted Grounds

The following grounds of unpatentability are what we determine are at issue in this preliminary proceeding:

Claims Challenged	Basis	Reference(s)
1–4, 9–14, and 21	§ 102	Ameerally
1–22, and 25–30	§ 103(a)	Ameerally, Zweig, Gautier, Frakes, Taylor, Anderson, iPod User Guide, and iMac User Guide
23 and 24	§ 103(a)	Ameerally, Zweig, Gautier, Frakes, Taylor, Anderson, iPod User Guide, iMac User Guide, Kondrk, and Suitts

Petitioner is particularly imprecise and unclear in its own articulation of the alleged grounds of unpatentability. For instance, the table provided on page 31 of the Petition identifies only what are referred to as the “primary

references,” to the exclusion of other references that might be combinable with the “primary references” to yield the subject matter of any claim. Also in that same table, on page 31 of the Petition, Petitioner mixes the reference in support of anticipation and those in support of obviousness, such that it is unclear whether each of the identified references serves as a basis for the anticipation allegation. Neither Patent Owner nor the Board should have to attempt to piece together every possible permutation of the alleged grounds by working backwards from the discussions, and, even then, the result likely would be subject to reasonable dispute, depending on the manner in which a prior art reference is referred to in the discussion. We decline to do so, beyond noting in the above table the three specific grounds with respect to which we determine Patent Owner and the Board have been given reasonable notice.

All other grounds potentially arguable by Petitioner, as having been presented in the Petition, are not recognized because they have not been identified with sufficient specificity. Because Petitioner bears the burden of proof for establishing unpatentability at trial, it must be clear in its Petition with regard to its assertions, so that Patent Owner may respond appropriately, without confusion, and so that the Board can make a proper adjudication.

## II. ANALYSIS

The question of obviousness is resolved on the basis of underlying factual determinations including: (1) the scope and content of the prior art; (2) any differences between the claimed subject matter and the prior art; (3) the level of ordinary skill in the art; and (4) objective evidence of nonobviousness. *Graham v. John Deere Co.*, 383 U.S. 1, 17–18 (1966).

One seeking to establish obviousness, based on more than one reference, also must articulate sufficient reasoning with rational underpinning to combine teachings. *See KSR Int'l Co. v. Teleflex, Inc.*, 550 U.S. 398, 418 (2007).

With regard to the level of ordinary skill in the art, we determine that no express finding is necessary, on this record, and that the level of ordinary skill in the art is reflected by the prior art of record. *See Okajima v. Bourdeau*, 261 F.3d 1350, 1355 (Fed. Cir. 2001); *In re GPAC Inc.*, 57 F.3d 1573, 1579 (Fed. Cir. 1995); *In re Oelrich*, 579 F.2d 86, 91 (CCPA 1978).

#### A. Claim Construction

In an *inter partes* review, claim terms in an unexpired patent are interpreted according to their broadest reasonable construction in light of the specification of the patent in which they appear. 37 C.F.R. § 42.100(b); *Cuozzo Speed Techs., LLC v. Lee*, 136 S. Ct. 2131, 2142–46 (2016). Consistent with that standard, claim terms also are generally given their ordinary and customary meaning, as would be understood by one of ordinary skill in the art in the context of the entire disclosure. *See In re Translogic Tech., Inc.*, 504 F.3d 1249, 1257 (Fed. Cir. 2007). There are, however, two exceptions to that rule: “1) when a patentee sets out a definition and acts as his own lexicographer,” and “2) when the patentee disavows the full scope of a claim term either in the specification or during prosecution.” *Thorner v. Sony Comp. Entm't Am. LLC*, 669 F.3d 1362, 1365 (Fed. Cir. 2012).

If an inventor acts as his or her own lexicographer, the definition must be set forth in the specification with reasonable clarity, deliberateness, and precision. *Renishaw PLC v. Marposs Societa' per Azioni*, 158 F.3d 1243, 1249 (Fed. Cir. 1998). It is improper to add into a claim an extraneous

limitation, i.e., one that is added wholly apart from any need for the addition. *See, e.g., Hogan AB v. Dresser Indus., Inc.*, 9 F.3d 948, 950 (Fed. Cir. 1993); *E.I. du Pont de Nemours & Co. v. Phillips Petroleum Co.*, 849 F.2d 1430, 1433 (Fed. Cir. 1988).

Only terms which are in controversy need to be construed, and only to the extent necessary to resolve the controversy. *See Wellman, Inc. v. Eastman Chem. Co.*, 642 F.3d 1355, 1361 (Fed. Cir. 2011); *Vivid Techs., Inc. v. Am. Sci. & Eng'g, Inc.*, 200 F.3d 795, 803 (Fed. Cir. 1999).

“or”

Petitioner urges that we should construe “or” as “a choice between either one of two alternatives, but not both.” Pet. 15. What Petitioner desires is that the word “or” requires the satisfaction of one, and only one, listed choice, to the exclusion of all others. We do not read the term this narrowly, under the rule of broadest reasonable interpretation. Petitioner cites to *Kustom Signals, Inc. v. Applied Concepts, Inc.*, 264 F.3d 1326, 1331–1332 (Fed. Cir. 2001) as supporting its position. *Id.* But the rule of broadest reasonable interpretation was inapplicable in *Kustom Signals*, and the words of a claim are not construed in light of the specification of an unrelated patent. We see no reason to construe narrowly the word “or” to require the satisfaction of only one choice, to the exclusion of the satisfaction of all other choices. The word itself conveys no such restrictive meaning. If it is the case that the alternatives are such that only one choice possibly can be met, then the exclusion stems from the nature of the alternatives themselves, and not from the word “or.”

*“two way data exchange session”*

Petitioner urges that we construe “two way data exchange session” as “the ability to receive and send data.” Pet. 18. Petitioner does not explain how its proposed construction is any different from the plain and ordinary meaning of the phrase in the English language. We agree with Patent Owner that no express construction is necessary for this phrase. Prelim. Resp. 24.

*“metadata of the digital content”*

Petitioner urges that we construe “metadata of the digital content” to be “data about the digital content.” Pet. 17. Patent Owner expressed no specific opposition in its Preliminary Response, other than to say that no construction is necessary. Prelim. Resp. 24. We have reviewed paragraphs 61–64 of the Declaration of Mr. Cherukuri (Ex. 1019), which is cited by Petitioner. Mr. Cherukuri testifies:

62. The '860 Patent defines metadata as to “describe other data.” [See '860 Patent at 13:24–26.] It is well known in the art that metadata need not be in the media file as the digital content. It can be separate.

63. The term “metadata” is well-known in the art, and includes [] data describing the encrypted digital media. Metadata is not necessarily connected to or physically in the content file, but can be. Rather, the metadata can be [a] separate file that includes information or data about the digital media.

Ex. 1019 ¶¶ 62, 63. We agree with Petitioner, and, on this record, determine that the broadest reasonable interpretation of “metadata of the digital content” is “data about the digital content.”

*“the request comprising a verification token provided by a first user, corresponding to the digital content”*

Petitioner states that during the IPR2016-00789 proceeding, which also involved related U.S. Patent 8,402,555, the Board construed a substantially identical phrase, i.e., “the request comprising a membership verification token provided by a first user, corresponding to the encrypted digital media” such that the portion “corresponding to the encrypted digital media” modifies the term “membership verification token.” Pet. 16.

Petitioner states that it agrees with that construction and submits that, for the same reasons, the phrase here should be construed such that the portion “corresponding to the digital content” modifies the term “verification token.” *Id.* Patent Owner does not express a view, beyond saying that no construction is necessary. Prelim. Resp. 24. We determine, on this record, that according to the plain and ordinary reading of the phrase at issue under the broadest reasonable interpretation, it is true that the portion “corresponding to the digital content” modifies the term “verification token.”

*“verified web service”*

Petitioner urges that the term “verified web service” should be construed to mean “a web service that can be used to identify a user or device.” Pet. 16. Petitioner explains:

Outside the claims, the term “verified web service” appears only once:

The web service equipped with the API is usually a well-known membership themed application in which the users must use an authentic identification. Some example [sic] includes Facebook in which as a rule, members are required to use their legal

names identities. A reference number or name with the Facebook Platform API represents this information. Other *verified web services* in which real member names are required such as the LinkedIn API and the PayPal API and even others could be used, but for this discussion, Facebook will be used only as an example of how the authentication element of the invention is utilized. ('860 Patent, 10:41–51).

Pet. 16–17. Mr. Cherukuri testifies that the '860 patent describes that an electronic identification reference is obtained from any web service capable of identifying a user or device, such as a device serial number, a networking MAC address, or a membership ID reference from a web service. Ex. 1019 ¶ 56. Each of independent claims 1, 9, 11, and 21 further recites that the identification reference comprises “one or more of a verified web service account identifier, letter, number, rights token, e-mail, password, access time, serial number, address, manufacturer identification, checksum, operating system version, browser version, credential, cookie or key.” Patent Owner does not express a view, beyond saying that no construction is necessary. Prelim. Resp. 24.

In light of the claim recitations, the cited portion of the Specification of the '860 patent, and the corresponding testimony of Mr. Cherukuri, we determine that “verified” in “verified web service” refers to authentication of a permissible user or device, and that the phrase “verified web service” means a web service that can be used to identify a user or device.

B. Alleged Anticipation of Claims 1–4, 9–14, and 21  
by Ameerally under 35 U.S.C. § 102

To establish anticipation, each and every element in a claim, arranged as recited in the claim, must be found in a single prior art reference.



*Net MoneyIN, Inc. v. VeriSign, Inc.*, 545 F.3d 1359, 1369 (Fed. Cir. 2008); *Karsten Mfg. Corp. v. Cleveland Golf Co.*, 242 F.3d 1376, 1383 (Fed. Cir. 2001). While the elements must be arranged in the same way as is recited in the claim, “the reference need not satisfy an *ipsissimis verbis* test.” *In re Gleave*, 560 F.3d 1331, 1334 (Fed. Cir. 2009); *In re Bond*, 910 F.2d 831, 832–33 (Fed. Cir. 1990)). Thus, identity of terminology between the prior art reference and the claim is not required. “A reference anticipates a claim if it discloses the claimed invention ‘such that a skilled artisan could take its teachings in combination with his own knowledge of the particular art and be in possession of the invention.’” *In re Graves*, 69 F.3d 1147, 1152 (Fed. Cir. 1995). Also, “it is proper to take into account not only specific teachings of the reference but also the inferences which one skilled in the art would reasonably be expected to draw therefrom.” *In re Preda*, 401 F.2d 825, 826 (CCPA 1968).

1. Ameerally

Ameerally is directed to a method of operating a digital media purchase system, including receiving a unique promotional code from one of a plurality of consumers via a data network. Ex. 1003, Abstr. “The receipt is in association with a user account of the one consumer with the digital media purchase system.” *Id.* A database associated with the media purchase system is used to determine particular digital media items associated with the received promotional code. *Id.* “A user account of the one consumer with the media purchase system is configured to enable access to the determined particular digital media from the media purchase system.” *Id.*

At one step within Ameerally’s method, after determining the particular digital media content associated with the received promotional

code (step 316), but prior to making that determined digital media content accessible to the consumer (step 318), there is step 317 that performs account handling. *Id.* at Fig. 3. In that regard, Ameerally describes:

Step 317 includes processing associated with user accounts with the digital media purchase system 100. If the user is already logged in to an account with digital media purchase system 100, then processing continues at step 318. Otherwise, the user is prompted to log into an account (if the user has previously created an account) or to create an account. Most of the step 317 processing, for account handling, is part of a conventional digital media purchase system. In some examples, a user account may [comprise] merely the particular session in which the user is interacting with the digital media purchase system via a client, and no pre-existing and/or after-existing relationship is implied.

*Id.* ¶ 41.

## 2. Discussion

### a. Claims 1, 9, 11, and 21

Claim 1 begins by reciting: “A method for authorizing access to digital content using a cloud system, the cloud system comprising connected modules in operation as one or more of a cloud computing or a cloud storage in connection with devices and users, wherein the digital content is at least one of encrypted or not encrypted, the method facilitating access rights between a plurality of data processing devices.” Ex. 1001, 14:31–37. The recitation of a “cloud system” is not just for indicating a non-limiting intended use, because the body of claim 1 requires a read or write request to be performed in connection with a combination of at least one device and the cloud system, both of which are recited in the preamble. *Id.* at 14:40–44.

As we have noted above, and also as argued by Petitioner (Pet. 32–33), Ameerally discloses a media purchase system including a digital media

storage server, that provides access to digital items which have been purchased by a user. Ex. 1003 ¶¶ 4, 9, 19, 23, 45. Mr. Cherukuri testifies that Ameerally describes that its system confirms that a code submitted by a user has not been used previously and satisfies other eligibility requirements prior to authorizing the user access to the digital media. *Id.* ¶ 129. Based on the foregoing, Petitioner has sufficiently shown that Ameerally discloses a method for authorizing access to digital media content, encrypted or non-encrypted.

With respect to the use of a cloud system, Mr. Cherukuri testifies:

111. Ameerally refers to the iTunes Music Store® by name at [0006] and [0007], and includes screenshots from iTunes in FIGS. 5, 6, and 7. Text in FIG. 5 identifies various requirements for redeeming the disclosed codes, including hardware and software requirements, and the requirement that codes “must be redeemed through the iTunes Music Store.”

115. With regard to the “cloud system,” Apple’s cloud system infrastructure was well known, with Apple providing service worldwide, such that anyone of ordinary skill reading Ameerally would have understood that the disclosed digital media purchase system was a “a cloud system, the cloud system comprising connected modules in operation as one or more of a cloud computing or a cloud storage in connection with devices and users.”

Ex. 1019 ¶¶ 111, 115. Further, Mr. Cherukuri cites to publications to support the above-noted testimony. For instance, he testifies:

116. Apple iTunes system included multiple data centers and used global content delivery networks to distribute content to users. This is described, among other places, in Miller on page 2: “The new North Carolina facility will be nearly five times the size of the 109,000 square foot Newark, Calif. data center Apple bought in 2006 to support its growing infrastructure. Apple also operates a data center in its Cupertino, Calif. campus, and has used content delivery networks from Akamai (AKAM) and

Limelight Networks (LLNW) to distribute content to its users around the globe.”; also Gautier [0142]: “The computer readable medium can also be distributed over network-coupled computer systems so that the computer readable code is stored and executed in a distributed fashion.”

*Id.* ¶ 116. For the foregoing reasons, Petitioner has sufficiently shown that Ameerally’s method makes use of a cloud system as is recited in the claim.

We add for completeness that Petitioner offers another reason why Ameerally’s method uses a cloud system as is required by claim 1, but a reason which we do not deem sufficiently persuasive. Specifically, Petitioner asserts:

In *Ameerally*, system components and client devices are connected via a data network 106 (a cloud), including a media commerce server 102, media store 110, promotional database 116, and optionally the “separate digital media storage server.” (Cherukuri Decl. ¶¶ 107–113). Thus, the claimed “cloud system comprising connected modules in operation as one or more of a cloud computing or a cloud storage” is disclosed. (*Id.*)

Pet. 34–35. The argument pertains to Figure 1 of Ameerally, which we reproduce below:

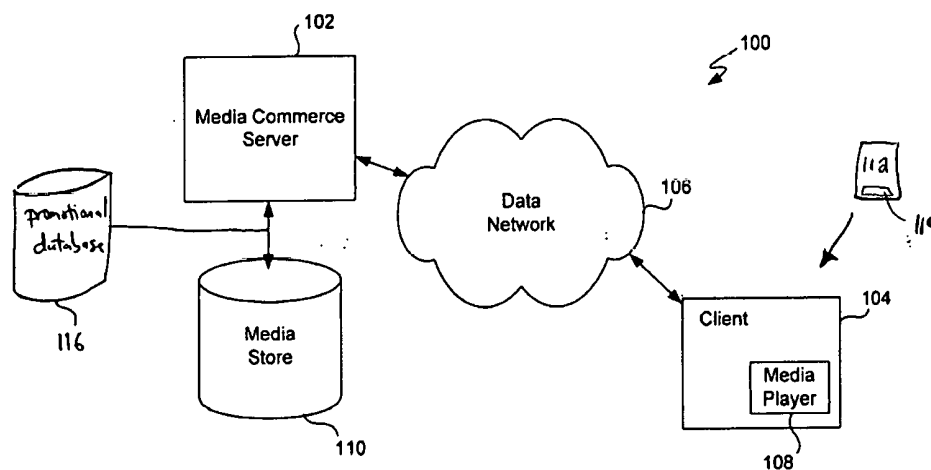

**FIG. 1**

Figure 1 illustrates an embodiment of Ameerally's digital media purchase system. As is shown in the above illustration, none of media commerce server 102, media store 110, and promotional database 116 is located within data network 106, and nothing indicates the optional "separate digital media storage server" as being located within data network 106. Those components may all be situated locally, and not distributed across a wide-area network.<sup>9</sup>

With regard to facilitating access rights between a plurality of data processing devices, Petitioner asserts that that would have been understood by one with ordinary skill in the art, based on the disclosure of Ameerally, because "[f]acilitating access rights between a plurality of data processing devices is a well-known and inherent feature of the Apple ecosystem described in Ameerally." Pet. 35. The assertion is supported by the testimony of Mr. Cherukuri. Ex. 1019 ¶ 114. Petitioner also supports the assertion by citing Frakes, which pertains to the iTunes® system: "[y]ou can play [the encrypted downloaded movie] in iTunes or Front Row, and you can transfer it to an iPod, iPhone, Apple TV, or another Mac." Pet 35 (citing Ex. 1019 ¶ 114). Petitioner has sufficiently shown that Ameerally's method facilitates accessing rights between a plurality of data processing devices.

Claim 1 further recites: "receiving a digital content access request from at least one communications console of the plurality of data processing devices, the access request being a read or write request of metadata of the digital content, wherein the read or write request of metadata is performed in

---

<sup>9</sup> Consistent with the claim language and the testimony of Mr. Cherukuri, we understand a cloud system as having its components distributed over a wide-area or non-local network such as the Internet.

connection with a combination of at least one device and the cloud system, the request comprising a verification token provided by a first user corresponding to the digital content, wherein the verification token is one or more of a password, e-mail address, payment system, credit card, authorize ready device, rights token, or one or more redeemable instruments of trade.”

Ex. 1001, 14:38–49. For reasons discussed below, Petitioner sufficiently establishes that Ameerally itself, as would have been read by one with ordinary skill in the art, discloses this limitation. Pet. 36–39. In particular, Ameerally describes:

The present invention pertains to methods and systems to employ unique promotional codes, associated with particular digital media items.

Ex. 1003 ¶ 8.

Here, the digital media commerce server 102 includes at least information (e.g., metadata) for a large number of digital media items that are available to be purchased from the media commerce server 102, though the content of the media items that are purchased may be acquired at the client via download with respect to another remote server, such as the media storage server.

*Id.* ¶ 26.

At step 314, the digital media purchase system 100 receives one of the unique promotional codes. Typically, as illustrated in FIG. 1, the promotional code is provided to the digital media purchase system 100 using the client 104 coupled to the digital media commerce server via the data network 106.

*Id.* ¶ 38.

At step 402, a unique promotional code is received. At step 404, the unique promotional code is evaluated (e.g., by processing a

database such as the database 306 in FIG. 3) to determine the promotion with which the promotional code is associated.

*Id.* ¶ 45.

Figure 2 of Ameerally is reproduced below:

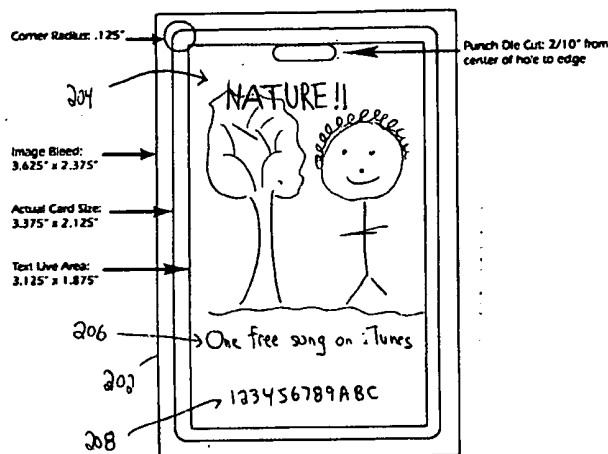

Fig. 2

Figure 2 illustrates a card-shaped promotional medium 202 having thereon unique promotional code 208 associated with a promotion by digital media purchase system 100. *Id.* ¶ 30. Ameerally describes that a user may manually enter the promotional code via the iTunes Music Store® page or, alternatively, the promotional media, such as an e-mail message, may contain a hyperlink that, when activated by a user, causes the promotional code to be automatically provided to digital media purchase system 100. *Id.* ¶ 47.

As is explained by Petitioner, the receiving limitation is met by Ameerally's disclosure that a user enters or submits a request in the form of a unique promotional code to the iTunes® media server. Pet. 39. Submission of the promotional code constitutes a read request of the metadata associated with the digital media content being promoted. In that

regard, Mr. Cherukuri testifies: “Submission of the request including the code in Ameerally causes the iTunes media server to read metadata of digital media corresponding to the code, such as the title, date and other file metadata associated with the media.” Ex. 1019 ¶ 126. Mr. Cherukuri further explains that the metadata of the digital content must be read, because Ameerally’s FIG. 6 shows the metadata of the corresponding digital content being displayed for the user on the client device. *Id.* ¶ 127.

Also, as explained above, one with ordinary skill in the art, reading Ameerally, would have understood that the iTunes® system referred to in Ameerally has a cloud infrastructure. *See* Ex. 1019 ¶ 115. Thus, the request in Ameerally is performed in connection with a device and a cloud system. Furthermore, Ameerally’s promotional code constitutes the claimed “verification token.” In that regard, Mr. Cherukuri testifies: “The ‘promotional codes’ described in Ameerally correspond to the claimed ‘verification token.’ The codes are described as unique and ‘correspond[] to the digital content.’” *Id.* ¶ 125. Mr. Cherukuri further testifies: “Ameerally’s unique promotional code, hypertext link ([0031]), and bar code ([0031]) all correspond to [a] redeemable instrument of trade. *See*, e.g., Ameerally [0042] characterizing free as a 100% discount.” *Id.* ¶ 128.

Claim 1 recites a step of “authenticating the verification token.” Ex. 1001, 14:50. Citing the testimony of Mr. Cherukuri, Petitioner asserts that Ameerally discloses using database 306 to authenticate the promotional code submitted by a user, and explains that the database would confirm whether the promotional code has not been used previously. Pet. 40. The assertion is supported by the testimony of Mr. Cherukuri. Ex. 1019 ¶ 129. Mr. Cherukuri further testifies that, as described by Ameerally, there may be



other eligibility requirements associated with the promotional codes, such as the residence of the user or dates of eligibility. *Id.* Accordingly, Petitioner sufficiently establishes that Ameerally discloses the step of authenticating the verification token.

Claim 1 recites: “establishing a connection with the at least one communications console, wherein the communications console is a combination of a graphic user interface (GUI) and an Application Programmable Interface (API) wherein the API is obtained from a verified web service, the web service capable of facilitating a two way data exchange session to complete a verification process wherein the data exchange session comprises at least one identification reference.” Ex. 1001, 14:51–59 (“establishing clause”).

Claim 1 also recites: “requesting the at least one identification reference from the at least one communications console, wherein the identification reference comprises one or more of a verified web service account identifier, letter, number, rights token, e-mail, password, access time, serial number, address, manufacturer identification, checksum, operating system version, browser version, credential, cookie, or key.” *Id.* at 14:60–67 (“requesting clause”).

Claim 1 further recites: “receiving the at least one identification reference from the at least one communications console.” *Id.* at 15:1–2 (“receiving clause”).

For the three limitations of the establishing clause, the requesting clause, and the receiving clause, Petitioner relies on the same disclosure of Ameerally. Ameerally describes:

Step 317 includes processing associated with user accounts with the digital media purchase system 100. If the user is already logged in to an account with digital media purchase system 100, then processing continues at step 318. Otherwise, the user is prompted to log into an account (if the user has previously created an account) or to create an account.

Ex. 1003 ¶ 41. Mr. Cherukuri testifies:

131. Referring to the “establishing a connection” clause in claim 1 of the ’860 Patent, The iTunes® media player interface on a user’s device is a “communications console” that “is a combination of a graphic user interface (GUI) and an Application Programmable Interface (API).” The GUI is illustrated, among other places, in Ameerally’s FIGS. 5–7, and the API is the API used by the iTunes media player to communicate with the iTunes system. Use of an API such as the iTunes store search API to communicate with the iTunes store (i.e., the server) is well known to one of ordinary skill in the art at the time of the invention. [See *e.g.*, Linking to the iTunes Music Store, version 1.2 dated December 07, 2009 available at <http://images.apple.com/itunesaffiliates/US/2009/Document/LinktoiTune.pdf>.]

132. The iTunes® media player interface is connected to and communicates with “two-day data exchange session” with the iTunes® media store. This is evident from the fact that all processing and communications is conducted through the iTunes® media player interface, which provide requests to and receive content from the iTunes® system.

133. The two way data exchange session to complete the verification process includes prompting the user to log into their account, and receiving their log in credentials (Ameerally [0041]).

134. The iTunes system is “a verified web service,” as users must be registered and authenticated to log into respective accounts. The user’s login includes (in part) their e-mail address,

which is the claimed “electronic identification reference,” since the user’s e-mail address identifies their account.

139. Ameerally discloses that “Typically, the media purchase system 100 would include a plurality of different clients 104, and each client 104 includes a digital media player 108. The digital media player 108 is an application program (e.g., specific software application, or web browser program) that operates on the client 104, which is a computing device.” (Ameerally [0019]).

140. The GUI in Ameerally is provided by the application program on the client 108, which in Ameerally’s FIG. 5, is identified as iTunes v. 4 or later. The iTunes application necessarily includes an API for accessing the iTunes Music Store, which is a web service that requires that the user log in with an account (such that it is a verified web service).

144. The log in information included a user’s e-mail address, which identifies their iTunes account, such that the user’s e-mail address is also the claimed “verified web service account identifier.” As noted above, iTunes is a verified web service.

145. Referring to the “receiving the at least one electronic identification reference” clause in claim 1 of the ’860 Patent, Ameerally says the user is logged into the digital media purchases system (Ameerally [0041]), such that the user’s e-mail address (i.e., “electronic identification reference”) which identifies their account is received by the iTunes® system through the iTunes® media player interface (i.e., “communications console”).

Ex. 1019 ¶¶ 131–134, 139, 140, 144, 145.

On this record, and notwithstanding the contrary arguments of Patent Owner, which we discuss below, we determine that Petitioner has sufficiently shown that Ameerally discloses each of the establishing clause, requesting clause, and the receiving clause limitations of claim 1.

Patent Owner argues that each independent claim requires six separate steps or operations and, thus, Petitioner may not use the same operation in the prior art to meet a plurality of the required steps or operations. Prelim. Resp. 24–26. For instance, Patent Owner argues that Petitioner has used the operation of “establishing a connection” to also be the operations of “requesting an identification reference” and “receiving an identification reference.” *Id.* at 26. Patent Owner states: “In other words, assuming Ameerally establishes the connection with the verified web service when iTunes prompts the user to input her Apple ID, Ameerally does not use that connection to request and receive the identification reference, as disclosed in the ’860 claims.” *Id.* Patent Owner further states:

[Petitioner] admits this by lumping together the steps of “establishing the connection,” “requesting the identification reference,” and “receiving the identification reference” and pointing to the same prior art teachings to meet these different elements. (Paper 2 at 41–44, 57–58, 60–61, 66.) Simply put, if the user’s Apple ID is used in Ameerally to establish the connection, that Apple ID cannot then also be the identification reference, as [Petitioner] would have it.

*Id.* at 26–27. For reasons discussed below, Patent Owner’s arguments are misplaced and unpersuasive.

Claim 1 does not require a certain sequence between the establishing clause limitation, the requesting clause limitation, and the receiving clause limitation. Additionally, under the rule of broadest reasonable interpretation, nothing precludes the “establishing a connection” step or operation from also constituting the steps or operations of “requesting the identification reference” and “receiving the identification reference.” Although the ’860 patent discloses an embodiment, in which the connection with a verified web service is first established, and then that connection,

with the verified web service, is used to request and receive an electronic identification reference, the claims simply are not so narrow. *See SuperGuide Corp. v. DirecTV Enterprises, Inc.*, 358 F.3d 870, 875 (Fed. Cir. 2004) (“Though understanding the claim language may be aided by the explanations contained in the written description, it is important not to import into a claim limitations that are not a part of the claim. For example, a particular embodiment appearing in the written description may not be read into a claim when the claim language is broader than the embodiment.”).

Patent Owner notes that the applied prior art references do not mention “API.” Prelim. Resp. 27. Patent Owner argues that to the extent Mr. Cherukuri’s testimony (Ex. 1019 ¶ 131) accounts for the requirement of an API, there is improper incorporation by reference of the argument from Mr. Cherukuri’s declaration into the Petition. Prelim. Resp. 27. We are unpersuaded that there is improper incorporation by reference, in light of Petitioner’s expressly stated argument that: “The iTunes® media player interface on a user’s computer is a ‘communications console’ that ‘is a combination of a graphic user interface (GUI) and an Application Programmable Interface (API).’ (Cherukuri Decl. ¶¶ 131–133).” Pet. 43. There is sufficiently specific introduction on page 43 of the Petition that leads to the pertinent testimony of Mr. Cherukuri. Note also that Ameerally describes its digital media player 108 as “an application program, e.g., specific software application, or web browser program.” Ex. 1003 ¶ 19.

For the foregoing reasons, we are sufficiently persuaded that Ameerally discloses the “establishing clause” limitation, the “requesting clause” limitation, and the “receiving clause” limitation of claim 1.

Claim 1 recites: “writing at least one of the verification token or the [identification] reference into the metadata.” *Id.* at 15:3–4; Certificate of Correction (Sept. 10, 2013). Although this limitation requires the writing of only one of the verified token and the identification reference into the metadata, Petitioner takes the dual position that Ameerally discloses writing an identification reference into the metadata, and that it would have been obvious in light of Ameerally for one with ordinary skill in the art to write Ameerally’s promotional code, which is a verification token, into the metadata of the digital media content. Pet. 46–48.

Because the ground of unpatentability being discussed is that of anticipation based on Ameerally, Petitioner’s obviousness argument based on the disclosure of Ameerally does not help Petitioner and need not be further addressed. We focus, instead, on Petitioner’s argument that Ameerally discloses, “writing the identification reference into the metadata.” In that regard, Petitioner argues:

“Writing the identification reference into the metadata” was a well-known feature of iTunes® DRM, and would have been understood to be part of the metadata content (EX1003 [0025]). (Cherukuri Decl. ¶¶ 146–148). The inclusion of the identification reference is illustrated in the “Summary” screenshot in *Frakes*, where the displayed metadata of the iTunes® media file includes “Purchased By” and “Account Name” (grayed out in image for privacy, but fields illustrated), such that the claimed “reference” was necessarily written into the metadata as saved by iTunes®. (*Id.*)

This is further supported by Zweig, since when Alice shares media with Bob, for the iTunes® store to identify Alice’s decrypt key to provide access to Bob, the content store must identify that the shared media file had been encrypted for Alice (EX1004 [0074]). (Cherukuri Decl. ¶¶ 149–153). Having identified Alice from the metadata, the iTunes® system

regenerates the decrypt key for that particular file based on Alice's decrypt key and the unique header. (Id.) Thus, writing the identification reference into the metadata was an inherent feature of iTunes DRM, such that claim 1 is anticipated. (Id.)

Pet. 46–47.

Petitioner regards the user's login information, as received by the iTunes® system through the iTunes® media player interface, as the “electronic identification reference.” Pet. 44. Mr. Cherukuri testifies that that login information in the iTunes® system includes the user's e-mail address, which constitutes the “electronic identification reference.” Ex. 1019 ¶ 134. Rather than tracing what happens to this login information, e.g., e-mail address, after it is received, to see if it is then written into the metadata of the digital content, Petitioner starts anew with some other information that it believes is an “electronic identification reference” that is written into the metadata of the digital content.

Petitioner identifies (Pet. 45) a Figure from Frakes, reproduced below:

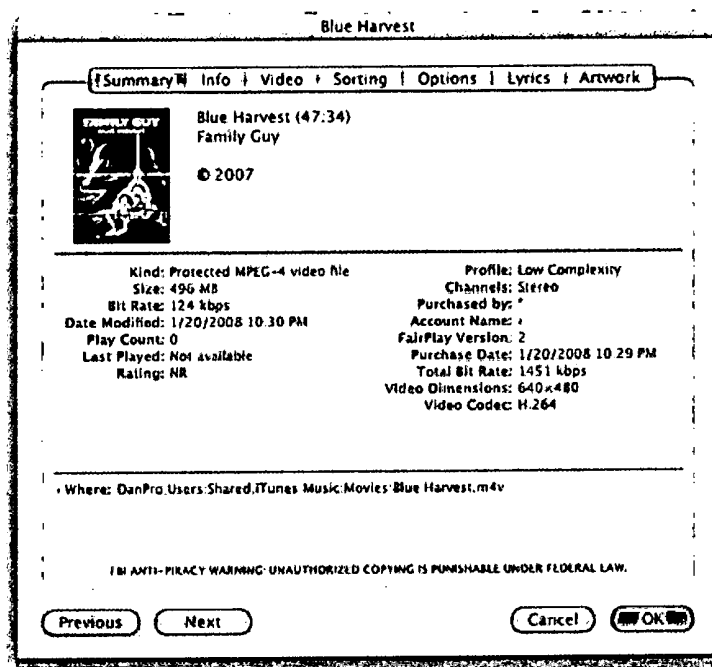

Ex. 1008, 5. The Figure illustrates detailed information kept by Frakes's iTunes® system for a digital movie file. *Id.* at 4. Petitioner asserts: “*Frakes* illustrates ‘Purchased By’ and ‘Account Name’ in the metadata of the iTunes® media file (grayed out in image for privacy, but field illustrated), such that the claimed ‘electronic identification reference’ was necessarily written into the metadata as saved by iTunes®. (Cherukuri Decl. ¶ 139).” Pet. 46. However, neither Petitioner nor Mr. Cherukuri explains why the “Purchased By” or “Account Name” field is necessarily the login information, e.g., the user’s e-mail address, that the iTunes® system had requested and received, as had been explained by Petitioner and Mr. Cherukuri above when accounting for requesting an electronic identification reference and receiving the electronic identification reference. It is not explained why the fields cannot be another identification reference other than the user’s e-mail address.

Petitioner, referring to *Zweig*, further argues:

This is further supported by *Zweig*, since when Alice shares media with Bob, for the iTunes® store to identify Alice’s decrypt key to provide access to Bob, the content store must identify that the shared media file had been encrypted for Alice. (EX1004 [0074]). (Cherukuri Decl. ¶¶ 149–153). Having identified Alice from the metadata, the iTunes® system regenerates the decrypt key for that particular file based on Alice’s decrypt key and the unique header. (*Id.*). Thus, writing the identification reference into the metadata was an inherent feature of iTunes DRM, such that claim 1 is anticipated. (*Id.*)

Pet. 46–47. The argument establishes that, in the metadata for the digital content purchased or downloaded by a user there is an identifier, an electronic identification reference, that identifies that user. However, neither Petitioner nor Mr. Cherukuri explains why that identifier in the metadata is



necessarily the login information, e.g., the user's e-mail address, that the iTunes® system had requested and received, as had been explained by Petitioner and Mr. Cherukuri above when accounting for requesting an electronic identification reference and receiving the electronic identification reference. It is not explained why the fields cannot be another identification reference.

Like claim 1, each of claims 9 and 11 requires the operation of “writing at least one of the verification token or the identification reference into the metadata.” Ex. 1001, 16:26–28; 17:13–14. Similarly, claim 21 requires the operation of “writing at least one of the verification token or the identification reference into the said metadata.” *Id.* at 18:32–33. Petitioner's accounting for these limitations are the same as its explanation for the same limitation in claim 1. For the same reasons discussed above in the context of claim 1, the same operation as is required by claims 9, 11, and 21 is not sufficiently accounted for by Petitioner.

Accordingly, Petitioner has not shown a reasonable likelihood that it would prevail in establishing unpatentability of any of claims 1, 9, 11, and 21 as anticipated by Ameerally.

b. Claims 2–4, 10, and 12–14

Claims 2–4 each depend, directly or indirectly, from claim 1. Claim 10 depends from claim 9. Claims 12–14 each depend, directly or indirectly, from claim 11. The deficiencies of Petitioner's arguments with respect to independent claims 1 and 9 carry through to dependent claims 2–4, 10, and 12–14. Thus, Petitioner has not shown a reasonable likelihood that it would prevail in establishing unpatentability of any of claims 2–4, 10, and 12–14 as anticipated by Ameerally.

C. Alleged Obviousness of Claims 1–22 and 25–30  
over Ameerally, Zweig, Gautier, Frakes, Taylor,  
Anderson, iPod User Guide, and iMac User Guide

1. Zweig

Zweig is directed to a system and method for granting users a right in a copy of a digital content unit, without having to download another copy of the same digital content. Ex. 1004 ¶ 19. It also is directed to a system and method for transcribing and converting a digital content unit encrypted, with a given key, into a decryptable copy of the digital content unit for a user having a legal right to obtain a copy of the digital content unit. *Id.* ¶ 20.

According to one embodiment of Zweig, each digital content unit in the digital content store is encrypted with a unique key based on the header of the content unit, and a secret key associated with a user. *Id.* ¶ 20. Zweig states that “[b]ecause the header is unique to each digital content unit, each digital content unit is encrypted with a unique key, even for the same user.” *Id.* ¶ 29. Each time a user purchases or downloads an encrypted digital content unit, a different decrypt key is generated. *Id.* ¶ 31.

Zweig discloses an embodiment in which user A provides user B a copy of the encrypted digital content purchased or downloaded by user A, and user B is provided authorization to access that copy, perhaps for a fee, as part of a subscription, in exchange for other consideration, or even for free for a finite period of time. *Id.* ¶¶ 68–69. The digital content user system in user B’s device would communicate, with a digital content distribution system in the digital content store, so as to obtain an appropriate key to decrypt the copy. *Id.* ¶¶ 70, 71. Zweig describes:

After obtaining the appropriate decrypt key to decrypt the copy, the digital content user system in user B’s device may decrypt the copy unit, and at operation 525, re-encrypt it with an

encrypt key associated with user B to generate a legitimate copy of the digital content unit for user B to enjoy. Alternatively, operation 525 may be performed by the digital content store 115 or digital content distribution system 200. In such embodiments, the entire copy unit may be transmitted to the store or system, or simply the header of the copy unit may be so transmitted.

*Id.* ¶ 75. Zweig explains: “As described hereinabove, one of ordinary skill in the art should understand that the legitimate copy may be generated without user B having to download the digital content unit from digital content store 115.” *Id.* ¶ 76.

## 2. Discussion

### a. Claims 1–8

Claim 1 has been discussed in detail above, in the context of alleged anticipation of claim 1 by Ameeraly. As explained above, Ameeraly discloses all limitations of claim 1 except for the step: “writing at least one of the verification token or the [identification] reference into the metadata.” Ex. 1001, 15:3–4. In the context of obviousness, however, Petitioner has shown sufficiently that it would have been obvious to one with ordinary skill in the art, in light of the disclosures of Ameeraly and Zweig, to write the promotional code of Ameeraly, which is a verification token, into the header of the digital media, or to write the unique serial number of Frakes, which is a verification code, into the header of the digital media, because they are unique and specific to the digital content. Pet. 47–49.

Specifically, Petitioner explains:

Regarding the claimed “writing the verification token . . . into the metadata,” *Zweig* teaches that having identified Alice from the metadata, the iTunes system regenerates the decrypt key for that particular file based on Alice’s decrypt key and the unique header. (Cherukuri Decl. ¶¶ 153–156). The uniqueness of the header must depend on more than Alice’s account

identifier, the media description information, and the media itself, since those alone would not differentiate headers if Alice acquired two distinct copies of a same song or movie. (Id.) Thus, there necessarily is unique identifier included in each file's header to differentiate copies. (Id.).

According to Zweig, the uniqueness of the header is important, since using a combination of the unique header and the user's key to create a unique file-specific key enables every file to be encrypted differently. (EX1004 [0030]). (Cherukuri Decl. ¶ 157). This also allows the iTunes® system to associate a single decrypt key with a user's account. (Id.)

Typically, *Anderson* discusses techniques for embedding unique codes or messages in digital media files. Such embedding could be "fingerprints which are hidden serial number", and the iTunes® system uses such "fingerprints." (EX1012, p. 710). (Cherukuri Decl. ¶ 158).

Pet. 47. Petitioner's assertions are supported by the testimony of Mr. Cherukuri. Ex. 1019 ¶¶ 153–159.

Petitioner explains that, based on Zweig's teaching that each header is unique, Frakes' teaching that Apple associates the unique serial number with the user's iTunes account, and *Anderson's* teachings that Apple embeds "fingerprints" that could include hidden serial numbers, it would have been obvious to write the serial number of Frakes or the promotional code of Ameerally into the header of the digital content. Pet. 48. The explanation is supported by the testimony of Mr. Cherukuri. Ex. 1019 ¶ 160.

Petitioner presents additional reasons for one with ordinary skill in the art to write the verification token into the metadata of the digital content.

Pet. 48–49. In particular, Petitioner states:

Further, the purpose of the unique codes in *Ameerally* and *Taylor* is promotional marketing. By embedding the unique promotional codes in the header of each user's copy of the media, when media is shared, the viral success of the promotion can be

monitored without the need to track the media from user to user. (Cherukuri Decl. ¶¶ 162–164). A consideration when monitoring the spread of media via sharing is the restrictions on collecting personal information on people in places such as Europe. Embedding the original promotion code in each shared copy has the added advantage of associating the shared media with the original promotion, without the need to store data that directly associates users with each other. (Id.).

*Id.* at 49. The assertions are supported by the testimony of Mr. Cherukuri. Ex. 1019 ¶¶ 162–164.

Moreover, with regard to the limitations of claim 1 other than the step of writing at least one of the verification token or the identification reference into the metadata, Petitioner’s position is even stronger in the context of the obviousness assertion than it was as discussed in the context of anticipation by Ameerally. For instance, with respect to “facilitating access rights between a plurality of data processing devices,” Frakes states: “You can play [the encrypted downloaded movie] in iTunes or Front Row, and you can transfer it to an iPod, iPhone, Apple TV, or another Mac.” Ex. 1008, 3.

With respect to receiving an access request that is “a read or write request of metadata,” Frakes discloses the entering of a code that is a serial number corresponding to the digital content and which is a redeemable instrument of trade (Ex. 1008, 3), and Taylor discloses the entering of a promotional code that corresponds to digital content and is a redeemable instrument of trade (Ex. 1009, 3). Both Frakes and Taylor refer to the iTunes® system by name and, thus, we are persuaded that their disclosure of entering codes is usable in Ameerally. With respect to authenticating the verification token, Frakes discloses checking to see if the entered code already has been used, because each code can be used only once. Ex. 1019

¶ 130 (citing Ex. 1008, 4). Frakes describes the iTunes® system and, thus, its disclosure of authenticating the inputted code is usable in Ameerrally.

With respect to the establishing clause, the requesting clause, and the receiving clause of claim 1, Frakes discloses that if the user is not currently logged into his or her iTunes® Store account, the user will be prompted to do so. Ex. 1008, 3. Also, Zweig describes that users accessing the iTunes® Music Store may do so with the use of iTunes client software residing in their user devices. Ex. 1004 ¶ 51.

With regard to claims 2–8, each of which depends, directly or indirectly, from claim 1, we have reviewed Petitioner’s arguments presented on pages 50–56 of the Petition and the associated underlying evidence. On this record, the presentation of Petitioner is sufficiently persuasive.

For the foregoing reasons, Petitioner has shown a reasonable likelihood that it would prevail in establishing that each of claims 1–8 would have been obvious over the combined teachings of Ameerrally, Zweig, Gautier, Frakes, Taylor, Anderson, iPod User Guide, and iMac User Guide.

b. Claims 11–20

Claim 11 is independent. Claims 12–20 each depend, directly or indirectly, from claim 11. Claim 11 recites a non-transitory computer medium comprising program code that performs certain steps (*id.* at 16:41–17:14). The steps performed by the program code are, essentially, the same as the steps that are recited in claim 1. The above-analysis of the various steps of claim 1 are applicable to claim 11, and need not be reiterated. Here, we address the recitation of a non-transitory computer medium comprising program code. Claim 11 specifies that the program code is “a part of an operating system software or downloaded in sections from a web server.”

Ex. 1001, 16:42–43. Claim 11 also recites that the operating system software is “coupled with a user executing a method for authorizing access to digital content.” *Id.* at 16:44–46. These requirements have been adequately addressed by the Petitioner.

Specifically, Petitioner cites to Gautier, which is the published version of U.S. Application 10/833,267. Ex. 1011. Ameerally incorporates by reference the entirety of U.S. Application 10/833,267. Ex. 1003 ¶ 1. Petitioner cites (Pet. 60) to Paragraph 142 of Gautier:

The invention is preferably implemented by software, but can also be implemented in hardware or a combination of hardware and software. The invention can also be embodied as computer readable code on a computer readable medium. The computer readable medium is any data storage device that can store data which can thereafter be read by a computer system. Examples of the computer readable medium include read-only memory, random-access memory, CD-ROMs, DVDs, magnetic tape, optical data storage devices, and carrier waves. The computer readable medium can also be distributed over network-coupled computer systems so that the computer readable code is stored and executed in a distributed fashion.

Ex. 1011 ¶ 142.

Claim 11 differs slightly from claim 1, in reciting that the read or write request “is performed in connection with a combination of the operating system software program and a cloud system.” Ex. 1001, 16:52–55. In contrast, the corresponding step of claim 1 recites that the read or write request “is performed in connection with a combination of at least one device and the cloud system.” *Id.* at 14:41–44. It is understood that the operating system program operationally relates to the operations that are being performed in the system with regard to the read or write request.

Thus, the read or write request in the prior art would have been performed in connection with the operating system software program.

On this record, in light of the cited disclosure of Gautier, Petitioner sufficiently has established that it would have been obvious to one with ordinary skill in the art that the various operations of claim 11, corresponding to the steps of claim 1, are executed by program code on a non-transitory computer medium, and that the program code is part of an operating system or downloaded in sections from a server. Gautier expressly states that the computer readable medium can be distributed such that the code therein is stored and executed in a distributed fashion. *Id.*

With regard to claims 12–20 each of which depends, directly or indirectly, from claim 11, we have reviewed Petitioner’s arguments presented on pages 61–65 of the Petition and the associated underlying evidence. On this record, the presentation of Petitioner is sufficiently persuasive.

For the foregoing reasons, Petitioner has shown a reasonable likelihood that it would prevail in establishing that each of claims 11–20 would have been obvious over the combined teachings of Ameerally, Zweig, Gautier, Frakes, Taylor, Anderson, iPod User Guide, and iMac User Guide.

c. Claims 9 and 10

Claim 9 is independent and claim 10 depends from claim 9. Claim 9 is reproduced below:

9. A system for authorizing access to digital content using a worldwide cloud system infrastructure, the worldwide cloud system infrastructure comprising connected modules in operation as computing and storage, the computing and storage comprising a server, a database, devices, and users, wherein the digital content is at least one of encrypted or not encrypted, the



system facilitating access rights between a plurality of data processing devices, the system working as a front-end agent for access rights authentication between the plurality of data processing devices, the system further comprising:

- a first receipt module, the first receipt module receiving a digital content access request from at least one communications console of the plurality of data processing devices, the access request being a read or write request of metadata of the digital content, wherein the read or write request of metadata is performed in connection with a combination of a device, the server, the database and the cloud system, the metadata further comprises one or more of a software or contents of a web page, the request comprising a verification token provided by a user corresponding to the digital content, wherein the verification token is one or more of a password, e-mail address, payment system, credit card, authorize ready device, rights token, or one or more redeemable instruments of trade;
- an authentication module, the authentication module authenticating the verification token;
- a connection module, the connection module establishing a connection with the at least one communications console, wherein the communications console is a combination of a graphic user interface (GUI) and an Application programmable Interface (API) wherein the API is obtained from a verified web service, the web service capable of facilitating a two way data exchange to complete a verification process wherein the data exchange session comprises at least one identification reference;
- a request module, the request module requesting the at least one identification reference from the at least one communications console, wherein the identification reference comprises one or more of a verified web service account identifier, letter, number, rights token, e-mail, password, access time, serial number, address, manufacturer identification, checksum, operating system version, browser version, credential, cookie, or key;

- a secondary receipt module, the secondary receipt module receiving the at least one identification reference from the at least one communications console; and
- a branding module, the branding module writing at least one of the verification token or the identification reference into the metadata.

Ex. 1001, 15:45–16:28.

Claim 9 raises its own separate issues relating to its recitation of various “modules” that perform respective operations. Claim 9 is an apparatus claim and each recited “module” represents a required structural element that performs the operation expressly recited for that “module.” It is not enough for the prior art just to meet the recited operation. The structural requirements of each module have to be satisfied as well.

On this record, a module does not identify any specific structure. Petitioner’s expert, Mr. Cherukuri, has not testified that, to one with ordinary skill in the art, “module” denotes a specific known structure or class of structures. Moreover, our reviewing court, the Court of Appeals for the Federal Circuit, has expressly noted that “[m]odule’ is a well-known nonce word that can operate as a substitute for ‘means’ in the context of § 112, para 6.” *Williamson v. Citrix Online, LLC*, 792 F.3d 1339, 1350 (Fed. Cir. 2015). The Court stated:

Generic terms such as “mechanism,” “element,” “device,” and other nonce words that reflect nothing more than verbal constructs may be used in a claim in a manner that is tantamount to using the word “means” because they “typically do not connote sufficiently definite structure” and therefore may invoke § 112, para. 6.

*Id.* Paragraph 6, 35 U.S.C. § 112, provides: “An element in a claim for a combination may be expressed as a means or step for performing a specified

function without the recital of structure, material, or acts in support thereof, and such claim shall be construed to cover the corresponding structure, material, or acts described in the specification and equivalents thereof.”<sup>10</sup>

Petitioner asserts on page 60 of its Petition in IPR2017-00788, directed to claims of related Patent No. 8,402,555 B2, that “[t]he recitation of modules is not limiting, being used solely to distinguish an entity or an action from others.” Ex. 3001, 60. Similar terms in related patents within the same family of patents ordinarily should be construed consistently. Petitioner’s assertion further indicates that “module” is used merely as a place holder or black box that does not itself set forth any structure. In that connection, Figure 1 of the ’860 patent is reproduced below:

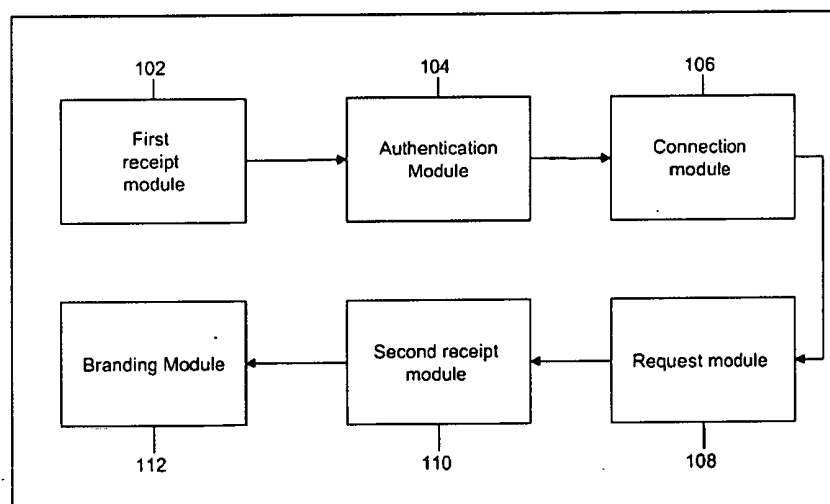

FIG. 1

---

<sup>10</sup> Paragraphs 1 through 6 of 35 U.S.C. § 112 were renamed as paragraphs (a) through (f) when § 4(c) of the Leahy-Smith America Invents Act, Pub. L. No. 112–29, 125 Stat. 284, 329 (2011) (“AIA”) took effect on September 16, 2012. Because the patent application resulting in the ’555 patent was filed before the effective date of the AIA, we refer to the pre-AIA version of § 112.

Figure 1 illustrates a block diagram of a system according to an embodiment according to the '860 patent. It shows merely black boxes or place holders corresponding to specific "module" functions.

Per 37 C.F.R. § 42.104(b)(3), a petition must identify the specific portions of the specification that describe the structure, material, or acts corresponding to each function of a means-plus-function claim limitation. That identification is not present in the Petition. Thus, even under Petitioner's assertion, it follows that Petitioner has not explained how any prior art teaching accounts for the structure of each of the "module" recitations in the claim.

Petitioner also argues:

The Apple references do not describe the functionality using "modules," but do refer to including "software routines and associated hardware." [E.g., *Zweig* (EX1004) [0049]. Referring FIG. 1 of *Ameerally*, the overall functionality provided by the iTunes® music store is distributed across multiple devices, with the media commerce server 102 working with the promotional database 116, the media store 110 and/or a separate digital media storage server (EX1003 [0023]), and the users' client devices 104, to provide access rights authorization to the media players 108 on the client devices 104. (Cherukuri Decl. ¶¶ 181–182). Configuring the different operations as software and/or hardware "modules" implies nothing more than a conventional and well-known networking architecture. (Id.).

Pet. 58. As quoted above, Petitioner identifies a multitude of structural elements in *Ameerally* as collectively performing the overall functionalities provided by the iTunes® system. That is inadequate to explain what specific structure is disclosed in the '860 patent as performing the specific operation at issue for each recited module, and why that specific structure is found in the prior art to perform the same corresponding function.

It is also not understood what Petitioner means in referring to configuring the operations as software and/or hardware modules. An operation is an activity or step that is performed, and a module, supposedly, is structure that performs the operation. The two are different in kind and one cannot be configured as the other. Even assuming what Petitioner intended to assert is just that a “module” is a conventional and well-known structure, the assertion is insufficient to establish what that structure is, that it was conventional for it to perform the particular operation at issue, or how it is met by the applied prior art.

Mr. Cherukuri testifies:

The Apple references do not describe the functionality using “modules,” but do refer to including “software routines and associated hardware.” [E].g., Zweig [0049]. As such, characterizing components of the system as modules was obvious.

Ex. 1019 ¶ 181. The testimony is not sufficiently specific. No specific algorithm is identified and neither is any specific hardware. The reference to “associated hardware” is patently vague. Also, the issue is not merely characterizing components as modules, but what in fact constitutes the specific module, and how it is found in the prior art. The testimony provides no answer. It is insufficient for Petitioner simply to show that, somewhere in the overall iTunes® system, something performs the recited operation or step at issue, to meet the limitation of any specific “module” that has been recited to perform a specified function.

In summary, for each of the specific modules recited in claim 9, we cannot discern, from the Petition, what Petitioner regards as the structure of the required module, and what Petitioner identifies as such a module in any of the prior art references. We recognize that claim 9 also recites a “cloud

system infrastructure comprising connected modules in operation as computing and storage, the computing and storage comprising a server, a database, devices, and users.” Ex. 1001, 15:47–49. That recitation is overly generic, and does not sufficiently define the particular structure of the various specifically recited modules. It is insufficient to define the structure of the various specific module recitations even if the iTunes® system, in general, includes a server, a database, devices, and users.

Petitioner has not shown a reasonable likelihood that it would prevail in establishing unpatentability of either claim 9 or claim 10 as obvious over Ameerally, Zweig, Gautier, Frakes, Taylor, Anderson, iPod User Guide, and iMac User Guide.

d. Claims 21, 22, and 25–30

Claim 21 is independent. Claims 22 and 25–30 each depend, directly or indirectly, from claim 21. Claim 21 recites:

A computer product comprising a memory, a CPU, a communications console and a non-transitory computer usable medium, the computer usable medium having an operating system stored therein, *the computer product further comprising a customization module*, the computer product authorizing access to digital content, wherein the digital content is at least one of an application, a video, or a video game, wherein the digital content is at least one of encrypted or not encrypted

Ex. 1001, 17:52–60 (emphasis added). Petitioner asserts: “Independent claim 21 is invalid for the reasons discussed above about independent claims 1, 9, and 11.” Pet. 65. However, none of claims 1, 9, and 11 recites a customization module. Petitioner’s discussion of claim 21, on pages 64–66 of the Petition, does not account for “customization module” in any way, except to say that (1) “[t]he preamble clause ‘further comprising a customization module’ is non-limiting on the metes and bounds of the claim

and should not be given patentable weight,” and (2) “[i]f the clause is given weight, the claim is nonetheless invalid for reasons discussed below about claim 24.” *Id.* at 64–65.

We disagree with Petitioner that “customization module” is only recited in the preamble of claim 21 and, thus, is non-limiting. Claim 21 begins with: “A computer product comprising a memory, a CPU, a communications console and a non-transitory computer usable medium, the computer usable medium having an operating system stored therein, the computer product further comprising a customization module, . . . .” Ex. 1001, 17:52–56. For this apparatus claim, the preamble is only the three words preceding “comprising,” i.e., “[a] computer product.” The recitation “customization module” is squarely within the central body of claim 21, and does not present merely a field of intended use. Rather, it is a structural element of the claimed computer product.

We also have reviewed Petitioner’s arguments regarding claim 24, presented on page 70 of the Petition. The arguments and underlying evidence only pertain to the function or operation supposedly performed by the customization module, and do not shed sufficient light on what specific structure is required by a customization module, and how that structure is found in the applied prior art to perform customization.

Furthermore, Petitioner’s prior discussion of claim 9 only attempts to account for modules in general. Pet. 58. As we explained above in the context of the analysis of claim 9, that is inadequate to explain what specific structure is disclosed in the ’860 patent as performing the specific operation at issue for a recited module, and why that specific structure is found in the prior art to perform the corresponding function. For the same reasons

discussed above, in connection with the various “modules” of claim 9, Petitioner has not made an adequate accounting for the “customization module” of claim 21.

The above-noted deficiency with respect to independent claim 21 carries through to each of dependent claims 22 and 25–30. Petitioner has not shown a reasonable likelihood that it would prevail in establishing obviousness of any of claims 21, 22, and 25–30 over Ameerally, Zweig, Gautier, Frakes, Taylor, Anderson, iPod User Guide, and iMac User Guide.

D. Alleged Obviousness of Claims 23 and 24 over  
Ameerally, Zweig, Gautier, Frakes, Taylor, Anderson  
iPod User Guide, iMac User Guide, Kondrk, and Suitts

Each of claims 23 and 34 depends from claim 21. Claim 23 further recites, relative to base claim 21: “wherein the customization module customizes the tag.” Ex. 1001, 18:43–44. Claim 24 further recites, relative to base claim 21: “wherein the customization module customizes a user access panel.” *Id.* at 18:45–46.

The deficiencies of Petitioner’s submission with regard to independent claim 21 carry through to dependent claims 23 and 24. We have reviewed Petitioner’s discussions with respect to claims 23 and 24, on pages 67–70 of the Petition. They do not cure the above-noted deficiencies with respect to base claim 21. Specifically, Petitioner’s additional explanations pertain to the function or operation that is performed by the claimed customization module, as further narrowed by claims 23 and 24, and does not provide any more specificity with respect to the structure of the customization module, whether in claims 23 and 24 or in the prior art references.

Petitioner has not shown a reasonable likelihood that it would prevail in establishing obviousness of either claim 23 or claim 24 over Ameerally,



Zweig, Gautier, Frakes, Taylor, iPod User Guide, iMac User Guide, Kondrk, and Suitts.

### III. CONCLUSION

Petitioner has not shown a reasonable likelihood that it would prevail in establishing that any of claims 1–4, 9–14, and 21 is unpatentable as anticipated by Ameerally.

Petitioner has not shown a reasonable likelihood that it would prevail in establishing that any of claims 9, 10, and 21, 22, and 25–30 would have been obvious over Ameerally, Zweig, Gautier, Frakes, Taylor, Anderson, iPod User Guide, iMac User Guide, Kondrk, and Suitts.

Petitioner has not shown a reasonable likelihood that it would prevail in establishing that either claim 23 or 24 would have been obvious over Ameerally, Zweig, Gautier, Frakes, Taylor, Anderson, iPod User Guide, iMac User Guide, Kondrk, and Suitts.

Petitioner has shown a reasonable likelihood that it would prevail in establishing that claims 1–8 and 11–20 would have been obvious over Ameerally, Zweig, Gautier, Frakes, Taylor, iPod User Guide, and iMac User Guide.

No final determination has yet been made with regard to the patentability of any claim.

### IV. ORDER

It is

ORDERED that, pursuant to 35 U.S.C. § 314(a), an *inter partes* review is instituted as to claims 1–8 and 11–20 of the '860 patent on the following ground of unpatentability:

IPR2017-00791  
Patent 8,533,860 B1

Claims 1–8 and 11–20 under 35 U.S.C. § 103(a) as obvious over Ameerally, Zweig, Gautier, Frakes, Taylor, Anderson, iPod User Guide, and iMac User Guide.

FURTHER ORDERED that no other ground of unpatentability, with respect to any claim, is instituted for trial; and

FURTHER ORDERED that pursuant to 35 U.S.C. § 314(c) and 37 C.F.R. § 42.4, notice is hereby given of the institution of a trial, which commences on the entry date of this decision.

Counsel for Petitioner:

Joseph Lanser  
David Klein  
Joseph Walker  
Brian Michaelis  
jlanser@seyfarth.com  
daklein@seyfarth.com  
jmwalker@seyfarth.com  
bmichaelis@seyfarth.com

Counsel for Patent Owner:

Isaac Rabicoff  
isaac@rabilaw.com

AO 120 (Rev. 08/10)

<b>TO: Mail Stop 8</b> <b>Director of the U.S. Patent and Trademark Office</b> <b>P.O. Box 1450</b> <b>Alexandria, VA 22313-1450</b>	<b>REPORT ON THE</b> <b>FILING OR DETERMINATION OF AN</b> <b>ACTION REGARDING A PATENT OR</b> <b>TRADEMARK</b>
---	---

In Compliance with 35 U.S.C. § 290 and/or 15 U.S.C. § 1116 you are hereby advised that a court action has been filed in the U.S. District Court Southern District of New York on the following

Trademarks or  Patents. (  the patent action involves 35 U.S.C. § 292.):

DOCKET NO. 16-cv-07026	DATE FILED 9/8/2016	U.S. DISTRICT COURT Southern District of New York
PLAINTIFF William Grecia		DEFENDANT Neiman Marcus Group, Inc.
PATENT OR TRADEMARK NO.	DATE OF PATENT OR TRADEMARK	HOLDER OF PATENT OR TRADEMARK
1 8,533,860	9/10/2013	WILLIAM GRECIA
2		
3		
4		
5		

In the above—entitled case, the following patent(s)/ trademark(s) have been included:

DATE INCLUDED	INCLUDED BY <input type="checkbox"/> Amendment <input type="checkbox"/> Answer <input type="checkbox"/> Cross Bill <input type="checkbox"/> Other Pleading	
PATENT OR TRADEMARK NO.	DATE OF PATENT OR TRADEMARK	HOLDER OF PATENT OR TRADEMARK
1 See Attached Sheet		See Attached Sheet
2		
3		
4		
5		

In the above—entitled case, the following decision has been rendered or judgement issued:

DECISION/JUDGEMENT  COPY ATTACHED: Notice of Dismissal
--

CLERK Ruby J. Krajick	(BY) DEPUTY CLERK s/ Javier Supelano	DATE 4/24/2017
--------------------------	---	-------------------

Copy 1—Upon initiation of action, mail this copy to Director Copy 3—Upon termination of action, mail this copy to Director  
 Copy 2—Upon filing document adding patent(s), mail this copy to Director Copy 4—Case file copy

EWS-003401

**UNITED STATES DISTRICT COURT  
SOUTHERN DISTRICT OF NEW YORK**

-----X

WILLIAM GRECIA,

Plaintiff,

v.

NEIMAN MARCUS GROUP, INC.,

Defendant.

16 Civ. 7026 (RJS)

**NOTICE OF VOLUNTARY  
DISMISSAL PURSUANT TO  
F.R.C.P. 41(a)(1)(A)(i)**

-----X

Plaintiff William Grecia, pursuant to Rule 41(a)(1)(A)(i) of the Federal Rules of Civil Procedure, hereby gives notice of dismissal of this action without prejudice. Defendant has not served an answer or motion for summary judgment.

Date: April 21, 2017

Respectfully Submitted,

/s/ Matthew M. Wawrzyn  
Matthew M. Wawrzyn (*pro hac vice*)  
*matt@wawrzynlaw.com*  
WAWRZYN & JARVIS LLC  
2700 Patriot Blvd, Suite 250  
Glenview, IL 60026  
847-656-5864

*Counsel for William Grecia*

<b>TO:</b> <b>Mail Stop 8</b> <b>Director of the U.S. Patent and Trademark Office</b> <b>P.O. Box 1450</b> <b>Alexandria, VA 22313-1450</b>	<b>REPORT ON THE</b> <b>FILING OR DETERMINATION OF AN</b> <b>ACTION REGARDING A PATENT OR</b> <b>TRADEMARK</b>
---	---

In Compliance with 35 U.S.C. § 290 and/or 15 U.S.C. § 1116 you are hereby advised that a court action has been filed in the U.S. District Court Northern District of Illinois on the following  Trademarks or  Patents. (  the patent action involves 35 U.S.C. § 292.):

DOCKET NO. 16-cv-10213	DATE FILED 10/31/2016	U.S. DISTRICT COURT Northern District of Illinois
PLAINTIFF William Grecia		DEFENDANT Cablevision Systems Corporation
PATENT OR TRADEMARK NO.	DATE OF PATENT OR TRADEMARK	HOLDER OF PATENT OR TRADEMARK
1 US 8,533,860 B1	9/10/2013	William Grecia
2 US 8,402,555 B2	3/19/2013	William Grecia
3		
4		
5		

In the above—entitled case, the following patent(s)/ trademark(s) have been included:

DATE INCLUDED	INCLUDED BY <input type="checkbox"/> Amendment <input type="checkbox"/> Answer <input type="checkbox"/> Cross Bill <input type="checkbox"/> Other Pleading		
PATENT OR TRADEMARK NO.	DATE OF PATENT OR TRADEMARK	HOLDER OF PATENT OR TRADEMARK	
1			
2			
3			
4			
5			

In the above—entitled case, the following decision has been rendered or judgement issued:

DECISION/JUDGEMENT
--------------------

CLERK Thomas G. Bruton	(BY) DEPUTY CLERK Michelle Copeland	DATE 11/1/2016
---------------------------	--	-------------------

Copy 1—Upon initiation of action, mail this copy to Director    Copy 3—Upon termination of action, mail this copy to Director  
 Copy 2—Upon filing document adding patent(s), mail this copy to Director    Copy 4—Case file copy

**UNITED STATES DISTRICT COURT  
FOR THE Northern District of Illinois – CM/ECF LIVE, Ver 6.1.1  
Eastern Division**

William Grecia

Plaintiff,

v.

Case No.: 1:16-cv-10213

Honorable Harry D. Leinenweber

Cablevision Systems Corporation

Defendant.

---

**NOTIFICATION OF DOCKET ENTRY**

This docket entry was made by the Clerk on Thursday, January 26, 2017:

MINUTE entry before the Honorable Harry D. Leinenweber: The Joint Motion to transfer case to the Southern District of New York and vacating all pending deadlines and hearing dates in this case [18] is granted. Civil case terminated. Mailed notice(wp, )

**ATTENTION:** This notice is being sent pursuant to Rule 77(d) of the Federal Rules of Civil Procedure or Rule 49(c) of the Federal Rules of Criminal Procedure. It was generated by CM/ECF, the automated docketing system used to maintain the civil and criminal dockets of this District. If a minute order or other document is enclosed, please refer to it for additional information.

For scheduled events, motion practices, recent opinions and other information, visit our web site at [www.ilnd.uscourts.gov](http://www.ilnd.uscourts.gov).

A TRUE COPY-ATTEST  
THOMAS G. BRUTON, CLERK

By: s/ MICHELLE COPELAND  
DEPUTY CLERK  
U.S. DISTRICT COURT, NORTHERN  
DISTRICT OF ILLINOIS

March 7, 2017

EWS-003404

(Page 1 of 2) Inventor and current owner of this letters patent hereby deposit for historical record —one use case— out of many possible use cases by which the Inventor and current patent owner is making, using, and selling the invention with concurrent venture ownership interests in the product, patent, and trademarks comprising all or a portion of the illustrations hereto. Signed this day June 2, 2017 /william grecia/

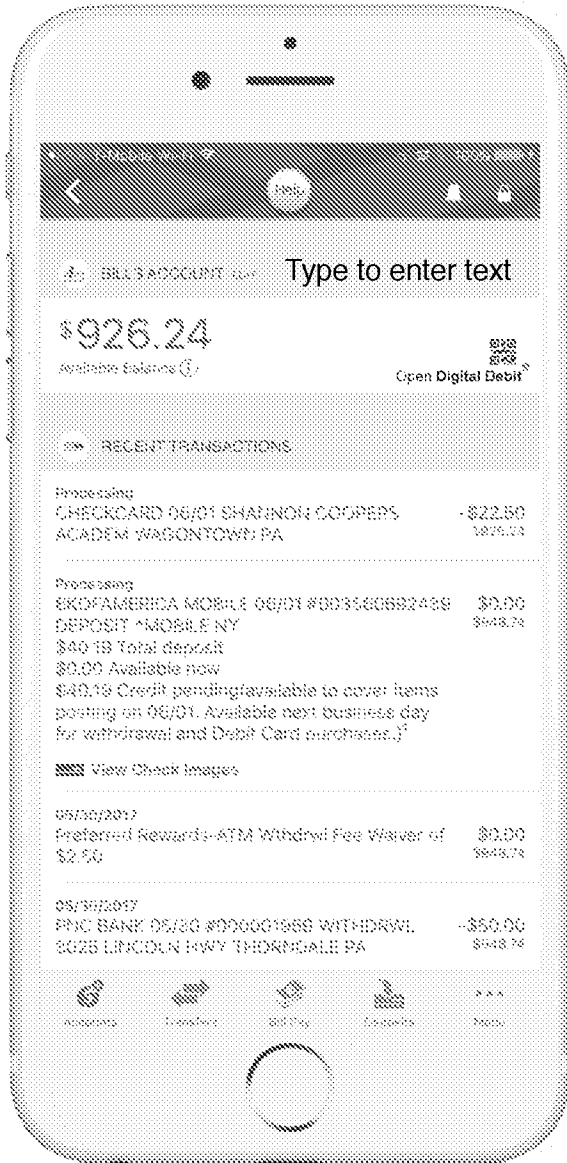

(Page 2 of 2) Inventor and current owner of this letters patent hereby deposit for historical record —one use case— out of many possible use cases by which the Inventor and current patent owner is making, using, and selling the invention with concurrent venture ownership interests in the product, patent, and trademarks comprising all or a portion of the illustrations hereto. Signed this day June 2, 2017 /william grecia/

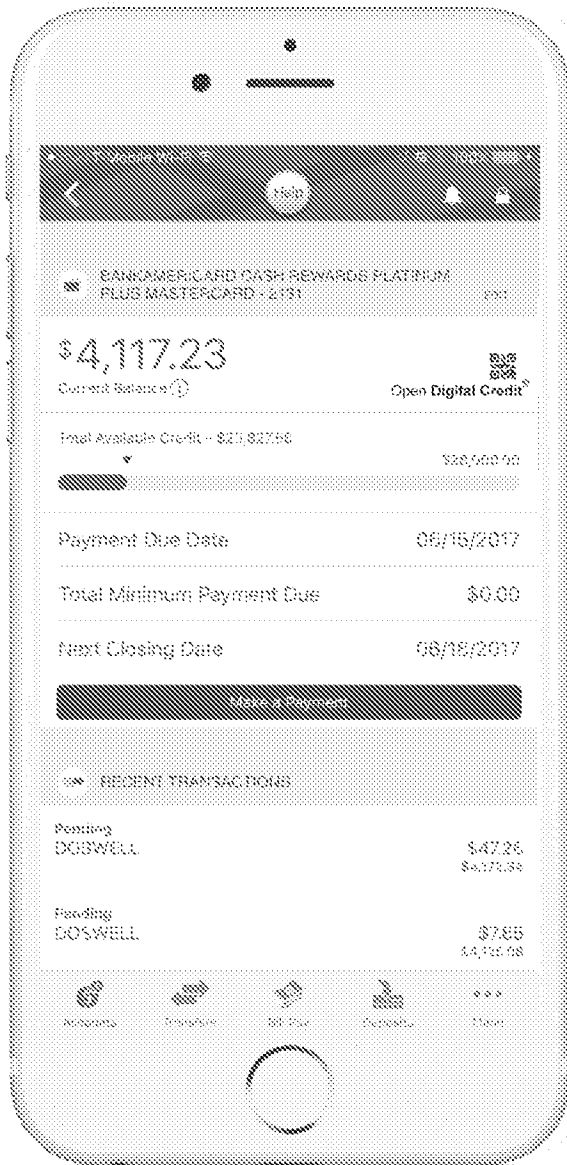



## Electronic Acknowledgement Receipt

<b>EFS ID:</b>	29376090
<b>Application Number:</b>	13740086
<b>International Application Number:</b>	
<b>Confirmation Number:</b>	7081
<b>Title of Invention:</b>	PERSONALIZED DIGITAL MEDIA ACCESS SYSTEM - PDMAS PART II
<b>First Named Inventor/Applicant Name:</b>	William Grecia
<b>Customer Number:</b>	70984
<b>Filer:</b>	William Grecia
<b>Filer Authorized By:</b>	
<b>Attorney Docket Number:</b>	
<b>Receipt Date:</b>	02-JUN-2017
<b>Filing Date:</b>	11-JAN-2013
<b>Time Stamp:</b>	08:28:34
<b>Application Type:</b>	Utility under 35 USC 111(a)

### Payment information:

Submitted with Payment	no
------------------------	----

### File Listing:

Document Number	Document Description	File Name	File Size(Bytes)/ Message Digest	Multi Part /.zip	Pages (if appl.)
1	Miscellaneous Incoming Letter	DDG_WG_IP_notice.pdf	4978386  <small>029545a6c559d14f1df57c620bae1e2a060b5699</small>	no	2

### Warnings:

EWS-003407

**Information:**

<b>Total Files Size (in bytes):</b>	4978386
-------------------------------------	---------

**This Acknowledgement Receipt evidences receipt on the noted date by the USPTO of the indicated documents, characterized by the applicant, and including page counts, where applicable. It serves as evidence of receipt similar to a Post Card, as described in MPEP 503.**

**New Applications Under 35 U.S.C. 111**

**If a new application is being filed and the application includes the necessary components for a filing date (see 37 CFR 1.53(b)-(d) and MPEP 506), a Filing Receipt (37 CFR 1.54) will be issued in due course and the date shown on this Acknowledgement Receipt will establish the filing date of the application.**

**National Stage of an International Application under 35 U.S.C. 371**

**If a timely submission to enter the national stage of an international application is compliant with the conditions of 35 U.S.C. 371 and other applicable requirements a Form PCT/DO/EO/903 indicating acceptance of the application as a national stage submission under 35 U.S.C. 371 will be issued in addition to the Filing Receipt, in due course.**

**New International Application Filed with the USPTO as a Receiving Office**

**If a new international application is being filed and the international application includes the necessary components for an international filing date (see PCT Article 11 and MPEP 1810), a Notification of the International Application Number and of the International Filing Date (Form PCT/RO/105) will be issued in due course, subject to prescriptions concerning national security, and the date shown on this Acknowledgement Receipt will establish the international filing date of the application.**

<b>TO: Mail Stop 8</b> <b>Director of the U.S. Patent &amp; Trademark Office</b> <b>P.O. Box 1450</b> <b>Alexandria, VA 22313-1450</b>	<b>REPORT ON THE</b> <b>FILING OR DETERMINATION OF AN</b> <b>ACTION REGARDING A PATENT OR</b> <b>TRADEMARK</b>
---	---

In Compliance with 35 § 290 and/or 15 U.S.C. § 1116 you are hereby advised that a court action has been filed in the U.S. District Court Northern District of California on the following:  
 Patents or  Trademarks

DOCKET NO:  
15-cv-02808-WHA

DATE FILED:  
[REDACTED]

UNITED STATES DISTRICT COURT  
 Phillip Burton Federal Building  
 450 Golden Gate Avenue  
 San Francisco, CA 94102

PLAINTIFF:  
Grecia

DEFENDANT:  
DISH Network L.L.C.

PATENT OR TRADEMARK NO.	DATE OF PATENT OR TRADEMARK	HOLDER OF PATENT OR TRADEMARK
1. <u>8,533,860</u>		
2.		
3.		
4.		
5.		

In the above-entitled case, the following patent(s) have been included.

DATE INCLUDED INCLUDED BY:  
 Amendment  Answer  Cross Bill  Other Pleading

PATENT OR TRADEMARK NO.	DATE OF PATENT OR TRADEMARK	HOLDER OF PATENT OR TRADEMARK
1.		
2.		
3.		
4.		
5.		

In the above-entitled case, the following decision has been rendered or judgment issued:

<b>DECISION/JUDGEMENT:</b>  CASE DISMISSED 2/3/2016
---

*Susan Y. Soong*

*D. Merry*

Susan Y. Soong, Clerk

(by) Deputy Clerk, D Merry

- Copy 1 – Upon initiation of action, mail this copy to Commissioner
- Copy 2 – Upon filing document adding patent(s) mail this copy to Commissioner
- Copy 3 – Upon termination of action, mail this copy to the Commissioner
- Copy 4 – Case file copy

AO 120 (Rev. 08/10)

TO: <b>Mail Stop 8 Director of the U.S. Patent and Trademark Office P.O. Box 1450 Alexandria, VA 22313-1450</b>	<b>REPORT ON THE FILING OR DETERMINATION OF AN ACTION REGARDING A PATENT OR TRADEMARK</b>
---	---

In Compliance with 35 U.S.C. § 290 and/or 15 U.S.C. § 1116 you are hereby advised that a court action has been filed in the U.S. District Court Northern District of Illinois on the following

Trademarks or  Patents. (  the patent action involves 35 U.S.C. § 292.):

DOCKET NO. 15CV2617	DATE FILED 3/27/2015	U.S. DISTRICT COURT Northern District of Illinois
PLAINTIFF William Grecia		DEFENDANT DirectTV, LLC
PATENT OR TRADEMARK NO.	DATE OF PATENT OR TRADEMARK	HOLDER OF PATENT OR TRADEMARK
1 8,533,860B1		
2		
3		
4		
5		

In the above—entitled case, the following patent(s)/ trademark(s) have been included:

DATE INCLUDED	INCLUDED BY <input type="checkbox"/> Amendment <input type="checkbox"/> Answer <input type="checkbox"/> Cross Bill <input type="checkbox"/> Other Pleading		
PATENT OR TRADEMARK NO.	DATE OF PATENT OR TRADEMARK	HOLDER OF PATENT OR TRADEMARK	
1			
2			
3			
4			
5			

In the above—entitled case, the following decision has been rendered or judgement issued:

DECISION/JUDGEMENT
--------------------

CLERK Thomas G. Bruton	(BY) DEPUTY CLERK T. Torres	DATE 12/15/2015
---------------------------	--------------------------------	--------------------

Copy 1—Upon initiation of action, mail this copy to Director Copy 3—Upon termination of action, mail this copy to Director  
Copy 2—Upon filing document adding patent(s), mail this copy to Director Copy 4—Case file copy

AO 120 (Rev. 08/10)

<b>TO: Mail Stop 8 Director of the U.S. Patent and Trademark Office P.O. Box 1450 Alexandria, VA 22313-1450</b>	<b>REPORT ON THE FILING OR DETERMINATION OF AN ACTION REGARDING A PATENT OR TRADEMARK</b>
---	---

In Compliance with 35 U.S.C. § 290 and/or 15 U.S.C. § 1116 you are hereby advised that a court action has been filed in the U.S. District Court Southern District of New York on the following

Trademarks or  Patents. (  the patent action involves 35 U.S.C. § 292.):

DOCKET NO. 17cv1784	DATE FILED 10/31/2016	U.S. DISTRICT COURT Southern District of New York
PLAINTIFF William Grecia		DEFENDANT Cablevision Systems Corporation
PATENT OR TRADEMARK NO.	DATE OF PATENT OR TRADEMARK	HOLDER OF PATENT OR TRADEMARK
1 US 8,533,860 B1	9/10/2013	William Grecia
2 US 8,402,555 B2	3/19/2013	William Grecia
3		
4		
5		

In the above—entitled case, the following patent(s)/ trademark(s) have been included:

DATE INCLUDED	INCLUDED BY <input type="checkbox"/> Amendment <input type="checkbox"/> Answer <input type="checkbox"/> Cross Bill <input type="checkbox"/> Other Pleading	
PATENT OR TRADEMARK NO.	DATE OF PATENT OR TRADEMARK	HOLDER OF PATENT OR TRADEMARK
1		
2		
3		
4		
5		

In the above—entitled case, the following decision has been rendered or judgement issued:

DECISION/JUDGEMENT
--------------------

CLERK Ruby J. Krajick	(BY) DEPUTY CLERK s/ C. Attanasio	DATE 4/6/2017
--------------------------	--------------------------------------	------------------

Copy 1—Upon initiation of action, mail this copy to Director Copy 3—Upon termination of action, mail this copy to Director  
Copy 2—Upon filing document adding patent(s), mail this copy to Director Copy 4—Case file copy

EWS-003411

USDC SDNY  
DOCUMENT  
ELECTRONICALLY FILED  
DOC #:  
DATE FILED: April 6, 2017

UNITED STATES DISTRICT COURT  
SOUTHERN DISTRICT OF NEW YORK

-----X  
:  
WILLIAM GRECIA, :  
:  
:  
Plaintiff, :  
:  
:  
v. :  
:  
CABLEVISION SYSTEMS :  
CORPORATION, :  
:  
Defendant. :  
-----X

17 Civ. 1784 (KPF)

ORDER  
OF DISCONTINUANCE

KATHERINE POLK FAILLA, District Judge:

By letter dated April 5, 2017, the parties reported to the Court that they have reached a settlement in this case. Accordingly, it is hereby:

ORDERED that this action be conditionally discontinued without prejudice and without costs; provided, however, that within thirty (30) days of the date of this Order, the parties may submit to the Court their own Stipulation of Settlement and Dismissal for the Court to So Order. Otherwise, within such time Plaintiff may apply by letter for restoration of the action to the active calendar of this Court in the event that the settlement is not consummated. Upon such application for reinstatement, the parties shall continue to be subject to the Court's jurisdiction, the Court shall promptly reinstate the action to its active docket, and the parties shall be directed to appear before the Court, without the necessity of additional process, on a date within ten (10) days of the application, to schedule remaining pretrial

proceedings and/or dispositive motions, as appropriate. This Order shall be deemed a final discontinuance of the action with prejudice in the event that Plaintiff has not requested restoration of the case to the active calendar within such 30-day period.

The Clerk of Court is directed to terminate all pending motions, adjourn all remaining dates, and close this case.

SO ORDERED.

Dated: April 6, 2017  
New York, New York



---

KATHERINE POLK FAILLA  
United States District Judge

AO 120 (Rev. 08/10)

<b>TO:</b> <b>Mail Stop 8</b> <b>Director of the U.S. Patent and Trademark Office</b> <b>P.O. Box 1450</b> <b>Alexandria, VA 22313-1450</b>	<b>REPORT ON THE</b> <b>FILING OR DETERMINATION OF AN</b> <b>ACTION REGARDING A PATENT OR</b> <b>TRADEMARK</b>
---	---

In Compliance with 35 U.S.C. § 290 and/or 15 U.S.C. § 1116 you are hereby advised that a court action has been filed in the U.S. District Court U.S. District Courts/Northern District on the following  
 Trademarks or  Patents. (  the patent action involves 35 U.S.C. § 292.):

DOCKET NO. 1:16-cv-10222	DATE FILED 10/31/2016	U.S. DISTRICT COURT U.S. District Courts/Northern District
PLAINTIFF William Grecia		DEFENDANT STARZ Entertainment, LLC
PATENT OR TRADEMARK NO.	DATE OF PATENT OR TRADEMARK	HOLDER OF PATENT OR TRADEMARK
1 US 8,533,860 B1	9/10/2013	William Grecia
2 US 8,402,555 B2	3/19/2013	William Grecia
3		
4		
5		

In the above—entitled case, the following patent(s)/ trademark(s) have been included:

DATE INCLUDED	INCLUDED BY <input type="checkbox"/> Amendment <input type="checkbox"/> Answer <input type="checkbox"/> Cross Bill <input type="checkbox"/> Other Pleading	
PATENT OR TRADEMARK NO.	DATE OF PATENT OR TRADEMARK	HOLDER OF PATENT OR TRADEMARK
1		
2		
3		
4		
5		

In the above—entitled case, the following decision has been rendered or judgement issued:

DECISION/JUDGEMENT
--------------------

CLERK Thomas G. Bruton	(BY) DEPUTY CLERK T. Torres	DATE 11/1/2016
---------------------------	--------------------------------	-------------------

Copy 1—Upon initiation of action, mail this copy to Director    Copy 3—Upon termination of action, mail this copy to Director  
Copy 2—Upon filing document adding patent(s), mail this copy to Director    Copy 4—Case file copy

EWS-003414



AO 120 (Rev. 08/10)

<b>TO: Mail Stop 8</b> <b>Director of the U.S. Patent and Trademark Office</b> <b>P.O. Box 1450</b> <b>Alexandria, VA 22313-1450</b>	<b>REPORT ON THE</b> <b>FILING OR DETERMINATION OF AN</b> <b>ACTION REGARDING A PATENT OR</b> <b>TRADEMARK</b>
---	---

In Compliance with 35 U.S.C. § 290 and/or 15 U.S.C. § 1116 you are hereby advised that a court action has been filed in the U.S. District Court Northern District of Illinois on the following

Trademarks or  Patents. (  the patent action involves 35 U.S.C. § 292.):

DOCKET NO. 16-cv-10213	DATE FILED 10/31/2016	U.S. DISTRICT COURT Northern District of Illinois
PLAINTIFF William Grecia		DEFENDANT Cablevision Systems Corporation
PATENT OR TRADEMARK NO.	DATE OF PATENT OR TRADEMARK	HOLDER OF PATENT OR TRADEMARK
1 US 8,533,860 B1	9/10/2013	William Grecia
2 US 8,402,555 B2	3/19/2013	William Grecia
3		
4		
5		

In the above—entitled case, the following patent(s)/ trademark(s) have been included:

DATE INCLUDED	INCLUDED BY <input type="checkbox"/> Amendment <input type="checkbox"/> Answer <input type="checkbox"/> Cross Bill <input type="checkbox"/> Other Pleading	
PATENT OR TRADEMARK NO.	DATE OF PATENT OR TRADEMARK	HOLDER OF PATENT OR TRADEMARK
1		
2		
3		
4		
5		

In the above—entitled case, the following decision has been rendered or judgement issued:

DECISION/JUDGEMENT
--------------------

CLERK Thomas G. Bruton	(BY) DEPUTY CLERK Michelle Copeland	DATE 11/1/2016
---------------------------	--	-------------------

Copy 1—Upon initiation of action, mail this copy to Director Copy 3—Upon termination of action, mail this copy to Director  
 Copy 2—Upon filing document adding patent(s), mail this copy to Director Copy 4—Case file copy

EWS-003415

UNITED STATES PATENT AND TRADEMARK OFFICE

---

BEFORE THE PATENT TRIAL AND APPEAL BOARD

---

AMERICAN EXPRESS TRAVEL RELATED SERVICES COMPANY,  
INC.,  
Petitioner,

v.

WILLIAM GRECIA,  
Patent Owner.

---

Case: IPR2017-00801  
Patent 8,533,860 B1

---

Before JAMESON LEE, MICHAEL W. KIM, and  
MICHELLE N. WORMMEESTER, *Administrative Patent Judges*.

LEE, *Administrative Patent Judge*.

JUDGEMENT  
Joint Motion to Terminate  
*37 C.F.R. §§ 42.72, 42.74*

On April 4, 2017, we authorized American Express Travel Related Services Company, Inc. (“Petitioner”) and William Grecia (“Patent Owner”) to file a joint motion to terminate the above-identified proceeding. On April 10, 2017, Petitioner and Patent Owner filed a Joint Motion to terminate this *inter partes* review proceeding. Paper 6 (“Joint Motion” or “Joint Mot.”). Petitioner and Patent Owner also filed a copy of their settlement and license agreement covering, *inter alia*, Patent No. 8,533,860 B1, at issue in this *inter partes* review. Ex. 1016 (“Settlement Agreement”). The parties represent that the filed copy of the Settlement Agreement is a true copy. Joint Mot. 3.

Other than the Petition, no substantive papers have been filed. The Board has not yet decided the merits of any issue in this proceeding, and a decision on whether to institute review has not yet issued. Petitioner and Patent Owner represent that the related District Court litigation in the Southern District of New York has been dismissed with prejudice. Joint Mot. 3.<sup>1</sup> Petitioner and Patent Owner filed a copy of the District Court’s Order dismissing the action. Ex. 1015. Petitioner and Patent Owner further represent that they have settled their dispute with respect to the patent at

---

<sup>1</sup> The Joint Motion cites “[t]he related District Court litigation between the Parties, No. 1:15-cv-09059-RJS (S.D.N.Y.)” Joint Mot. 3. The Order referenced in the Joint Motion, and submitted as Exhibit 1015, however, refers to *William Grecia v. American Express Co.*, No. 1:15-cv-9217 (RJS) (S.D.N.Y.). Ex 1015; *see also* Paper 5, 2 (citing “*Grecia v. MasterCard Incorporated*, Case. No. 1:15-cv-9059 (S.D.N.Y.)” and “*Grecia v. American Express Company*, Case No. 1:15-cv-9217 (S.D.N.Y.)”). We regard the reference to “[t]he related District Court litigation between the Parties, No. 1:15-cv-09059-RJS (S.D.N.Y.)” in the Joint Motion as a reference to *William Grecia v. American Express Co.*, No. 1:15-cv-9217 (RJS) (S.D.N.Y.).

issue. Joint Mot. 2. Accordingly, we determine that it is appropriate to terminate this proceeding.

Petitioner and Patent Owner also filed a Joint Request to File Settlement Agreement as Business Confidential Information. Paper 7 (“Joint Request”). The parties requested that the Settlement Agreement be filed as business confidential information, and that the Settlement Agreement be kept separate from the file of the patent involved in the *inter partes* review and be made available only on a showing of good cause or to Federal Government agencies on a written request. *Id.*

“A party to a settlement may request that the settlement be treated as business confidential information and be kept separate from the files of an involved patent or application. The request must be filed with the settlement. If a timely request is filed, the settlement shall only be available: (1) To a Government agency on written request to the Board; or (2) To any other person upon written request to the Board to make the settlement agreement available, along with the fee specified in § 42.15(d) and on a showing of good cause.” 37 C.F.R. § 42.74(c). After reviewing the Settlement Agreement between Petitioner and Patent Owner, we find that the Settlement Agreement contains confidential business information regarding the terms of settlement. We determine that it is appropriate to treat the Settlement Agreement between Petitioner and Patent Owner as business confidential information pursuant to 37 C.F.R. § 42.74(c).

ORDER

It is

ORDERED that the Joint Motion to Terminate (Paper 6), as to both Petitioner and Patent Owner, is *granted*;

IPR2017-00801  
Patent 8,533,860 B1

FURTHER ORDERED that the Joint Request (Paper 7) to treat the settlement agreement (Exhibit 1016) as business confidential information under 37 C.F.R. § 42.74(c) is *granted*; and

FURTHER ORDERED that this proceeding is terminated with respect to both Petitioner and Patent Owner.

IPR2017-00801  
Patent 8,533,860 B1

PETITIONER:

David Tennant

[dtennant@whitecase.com](mailto:dtennant@whitecase.com)

Shamita Etienne-Cummings

[setienne@whitecase.com](mailto:setienne@whitecase.com)

PATENT OWNER:

Isaac Rabicoff

[isaac@rabilaw.com](mailto:isaac@rabilaw.com)

AO 120 (Rev. 08/10)

<b>TO: Mail Stop 8</b> <b>Director of the U.S. Patent and Trademark Office</b> <b>P.O. Box 1450</b> <b>Alexandria, VA 22313-1450</b>	<b>REPORT ON THE</b> <b>FILING OR DETERMINATION OF AN</b> <b>ACTION REGARDING A PATENT OR</b> <b>TRADEMARK</b>
---	---

In Compliance with 35 U.S.C. § 290 and/or 15 U.S.C. § 1116 you are hereby advised that a court action has been filed in the U.S. District Court Northern District of Illinois on the following

Trademarks or  Patents. (  the patent action involves 35 U.S.C. § 292.):

DOCKET NO. 16cv10211	DATE FILED 10/31/2016	U.S. DISTRICT COURT Northern District of Illinois
PLAINTIFF William Grecia		DEFENDANT Big Ten Network Services, LLC
PATENT OR TRADEMARK NO.	DATE OF PATENT OR TRADEMARK	HOLDER OF PATENT OR TRADEMARK
1 SEE ATTACHMENT		
2		
3		
4		
5		

In the above—entitled case, the following patent(s)/ trademark(s) have been included:

DATE INCLUDED	INCLUDED BY <input type="checkbox"/> Amendment <input type="checkbox"/> Answer <input type="checkbox"/> Cross Bill <input type="checkbox"/> Other Pleading	
PATENT OR TRADEMARK NO.	DATE OF PATENT OR TRADEMARK	HOLDER OF PATENT OR TRADEMARK
1		
2		
3		
4		
5		

In the above—entitled case, the following decision has been rendered or judgement issued:

DECISION/JUDGEMENT
--------------------

CLERK Thomas G. Bruton	(BY) DEPUTY CLERK Jacqueline Hollimon	DATE 11/1/2016
---------------------------	--	-------------------

Copy 1—Upon initiation of action, mail this copy to Director Copy 3—Upon termination of action, mail this copy to Director  
 Copy 2—Upon filing document adding patent(s), mail this copy to Director Copy 4—Case file copy

EWS-003421



US008533860B1

(12) **United States Patent**  
**Grecia**

(10) **Patent No.:** **US 8,533,860 B1**  
(45) **Date of Patent:** **\*Sep. 10, 2013**

(54) **PERSONALIZED DIGITAL MEDIA ACCESS SYSTEM—PDMAS PART II**

(71) Applicant: **William Grecia, Brooklyn, NY (US)**

(72) Inventor: **William Grecia, Brooklyn, NY (US)**

(\* ) Notice: Subject to any disclaimer, the term of this patent is extended or adjusted under 35 U.S.C. 154(b) by 0 days.

This patent is subject to a terminal disclaimer.

2012/0041829	A1	2/2012	Rothschild
2012/0079099	A1	3/2012	Evans
2012/0079126	A1	3/2012	Evans
2012/0079276	A1	3/2012	Evans
2012/0079606	A1	3/2012	Evans
2012/0095871	A1	4/2012	Dorsey
2012/0095906	A1	4/2012	Dorsey
2012/0095916	A1	4/2012	Dorsey
2012/0130903	A1	5/2012	Dorsey
2012/0150727	A1	6/2012	Nuzzi
2012/0166333	A1	6/2012	Von Behren
2012/0173333	A1	7/2012	Berger
2012/0173431	A1	7/2012	Ritchie
2012/0173625	A1	7/2012	Berger
2012/0191553	A1	7/2012	Sathe
2012/0254340	A1	10/2012	Vehumyllum
2012/0255033	A1	10/2012	Dwivedi
2012/0290376	A1	11/2012	Dryer
2012/0298741	A1	11/2012	Dykes
2012/0310828	A1	12/2012	Hu
2013/0007892	A1	1/2013	Iaooka

(21) Appl. No.: **13/740,086**

(22) Filed: **Jan. 11, 2013**

(51) **Int. Cl.**  
**H04L 29/06** (2006.01)

(52) **U.S. Cl.**  
USPC ..... **726/29; 725/28; 713/185; 705/51**

(58) **Field of Classification Search**  
None  
See application file for complete search history.

**OTHER PUBLICATIONS**

Co-pending U.S. Appl. No. 13/397,517 document reference: Jan. 7, 2013 Examiner initiated interview summary (PTOL-413B).  
Co-pending U.S. Appl. No. 13/397,517 document reference: Dec. 26, 2012 Advisory Action (PTOL-303).  
Co-pending U.S. Appl. 13/397,517 document reference: Nov. 26, 2012 Final Rejection.

(56) **References Cited**

**U.S. PATENT DOCUMENTS**

7,244,235	B2	8/2007	Boudrenault et al.
7,343,014	B2	3/2008	Sovio et al.
7,526,650	B1*	4/2009	Wimmer ..... 713/176
8,250,145	B2	8/2012	Zuckerberg
8,280,949	B1	10/2012	Zuckerberg
2005/0665891	A1	3/2005	Lee et al.
2008/0010685	A1	1/2008	Holtzman et al.
2009/0083541	A1	3/2009	Levine
2010/0100899	A1	4/2010	Bradbury et al.
2011/0208695	A1	8/2011	Anand
2011/0265157	A1	10/2011	Ryder
2011/0288946	A1*	11/2011	Baiya et al. .... 705/26.1
2011/0313898	A1	12/2011	Singhal
2011/0320345	A1	12/2011	Taveau

(Continued)

*Primary Examiner* --- Jung Kim  
*Assistant Examiner* --- Tri Tran

(57) **ABSTRACT**

The invention is an apparatus that facilitates access to a data source to accept verification and authentication from an enabler using at least one token and at least one reference. The at least one reference could be a device serial number, a networking MAC address, or a membership ID reference from a web service. Access to the data source is also managed with a plurality of secondary enablers.

**30 Claims, 7 Drawing Sheets**

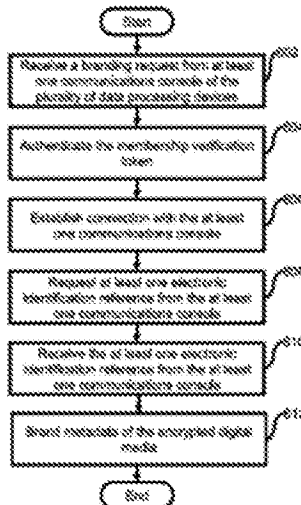





US008402555B2

(12) **United States Patent**  
**Grecia**

(10) **Patent No.:** **US 8,402,555 B2**  
(45) **Date of Patent:** **Mar. 19, 2013**

(54) **PERSONALIZED DIGITAL MEDIA ACCESS SYSTEM (PDMAS)**

(76) **Inventor:** William Grecia, Grandville, MI (US)

(\* ) **Notice:** Subject to any disclaimer, the term of this patent is extended or adjusted under 35 U.S.C. 154(b) by 0 days.

(21) **Appl. No.:** 13/397,517

(22) **Filed:** Feb. 15, 2012

(65) **Prior Publication Data**

US 2012/0151220 A1 Jun. 14, 2012

5,883,955 A	3/1999	Roaming	
5,887,060 A	3/1999	Roaming	
5,903,647 A	5/1999	Roaming	
5,907,617 A	5/1999	Roaming	
6,385,596 B1	5/2002	Wiser	
6,611,812 B2	8/2003	Hurtado	
6,665,797 B1	12/2003	Keung	
6,799,165 B1	9/2004	Boesjer	
7,254,235 B2 *	8/2007	Boudreau et al.	380/239
7,266,839 B2	9/2007	Bowers et al.	
7,290,699 B2	11/2007	Raddy	
7,340,769 B2	3/2008	Baughner	
7,343,014 B2 *	3/2008	Sovio et al.	380/278
7,386,513 B2	6/2008	Lau	
7,515,710 B2	4/2009	Grab	
7,816,495 B2	4/2009	Shoemaker	
7,526,650 B1 *	4/2009	Wimmer	713/176

(Continued)

**Related U.S. Application Data**

(63) Continuation of application No. 12/985,351, filed on Jan. 6, 2011, which is a continuation of application No. 12/728,218, filed on Mar. 21, 2010, now abandoned.

(51) **Int. Cl.**  
*H04L 29/06* (2006.01)

(52) **U.S. Cl.** ..... 726/29; 726/28; 713/185

(58) **Field of Classification Search** ..... 726/1-21, 726/26-33; 713/155-159, 168, 172-176, 713/185, 182

See application file for complete search history.

**FOREIGN PATENT DOCUMENTS**

EP	1505530 A1	2/2005
EP	1864621 A1	8/2005

(Continued)

**OTHER PUBLICATIONS**

Liu et al. 2004 NPL—A license-sharing scheme in Digital Rights Management.\*

(Continued)

*Primary Examiner* — Jung Kim  
*Assistant Examiner* — Tri Tran

(56) **References Cited**

**U.S. PATENT DOCUMENTS**

5,010,571 A	4/1991	Katznelson
5,247,575 A	9/1993	Sprague
5,267,313 A	11/1993	Hirata
5,319,705 A	6/1994	Haber
5,349,642 A	9/1994	Kingsdon
5,509,074 A	4/1996	Choudhury
5,586,186 A	12/1996	Yuval
5,719,938 A	2/1998	Haas
5,737,416 A	4/1998	Cooper
5,870,543 A	2/1999	Roaming
5,883,954 A	3/1999	Roaming

(57) **ABSTRACT**

The invention is an apparatus that facilitates access to encrypted digital media to accept verification and authentication from an excelsior enabler using at least one token and at least one electronic identification. The at least one electronic identification could be a device serial number, a networking MAC address, or a membership ID reference from a web service. Access to the product is also managed with a plurality of secondary enablers using the at least one electronic identification reference.

**26 Claims, 7 Drawing Sheets**

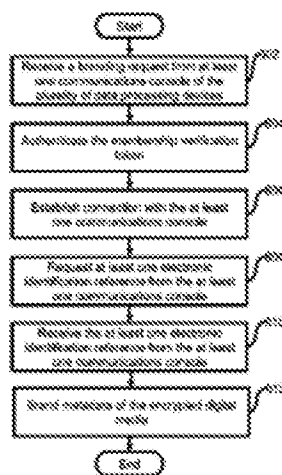





(12) **United States Patent**  
Grecia

(10) **Patent No.:** US 8,533,860 B1  
(45) **Date of Patent:** \*Sep. 10, 2013

(54) **PERSONALIZED DIGITAL MEDIA ACCESS SYSTEM—PDMAS PART II**

(71) Applicant: **William Grecia, Brooklyn, NY (US)**

(72) Inventor: **William Grecia, Brooklyn, NY (US)**

(\* ) Notice: Subject to any disclaimer, the term of this patent is extended or adjusted under 35 U.S.C. 154(b) by 0 days.

This patent is subject to a terminal disclaimer.

2012/0049829	A1	2/2012	Rothschild
2012/0079099	A1	5/2012	Evans
2012/0079126	A1	3/2012	Evans
2012/0079276	A1	3/2012	Evans
2012/0079606	A1	3/2012	Evans
2012/0095871	A1	4/2012	Dorsey
2012/0095906	A1	4/2012	Dorsey
2012/0095916	A1	4/2012	Dorsey
2012/0130903	A1	5/2012	Dorsey
2012/0150727	A1	6/2012	Nuzzi
2012/0166333	A1	6/2012	Von Behren
2012/0173333	A1	7/2012	Berger
2012/0173431	A1	7/2012	Ritchie
2012/0173625	A1	7/2012	Berger
2012/0191553	A1	7/2012	Sathe
2012/0254340	A1	10/2012	Vehumnylum
2012/0255033	A1	10/2012	Dwivedi
2012/0290378	A1	11/2012	Dryer
2012/0298741	A1	11/2012	Dykes
2012/0310828	A1	12/2012	Hu
2013/0007892	A1	1/2013	Isooka

(21) Appl. No.: **13/740,086**

(22) Filed: **Jan. 11, 2013**

(51) **Int. Cl.**  
**H04L 29/06** (2006.01)

(52) **U.S. Cl.**  
USPC ..... **726/29; 725/28; 713/185; 705/51**

(58) **Field of Classification Search**  
None  
See application file for complete search history.

**OTHER PUBLICATIONS**

Co-pending U.S. Appl. No. 13/397,517 document reference: Jan. 7, 2013 Examiner initiated interview summary (PTOL-413B).

Co-pending U.S. Appl. No. 13/397,517 document reference: Dec. 26, 2012 Advisory Action (PTOL-303).

Co-pending U.S. Appl. 13/397,517 document reference: Nov. 26, 2012 Final Rejection.

(56) **References Cited**

**U.S. PATENT DOCUMENTS**

7,284,235	B2	8/2007	Boudrenault et al.	
7,343,014	B2	3/2008	Savio et al.	
7,528,650	B1*	4/2009	Wimmer	713/176
8,250,145	B2	8/2012	Zuckerberg	
8,280,959	B1	10/2012	Zuckerberg	
2005/0665891	A1	3/2005	Lee et al.	
2006/0010685	A1	1/2008	Holtzman et al.	
2009/0083541	A1	3/2009	Levine	
2010/0100899	A1	4/2010	Bradbury et al.	
2011/0208695	A1	8/2011	Anand	
2011/0265157	A1	10/2011	Ryder	
2011/0288946	A1*	11/2011	Baiya et al.	705/26.1
2011/0313898	A1	12/2011	Singhal	
2011/0320345	A1	12/2011	Taveau	

(Continued)

*Primary Examiner* — Jung Kim  
*Assistant Examiner* — Tri Tran

(57) **ABSTRACT**

The invention is an apparatus that facilitates access to a data source to accept verification and authentication from an enabler using at least one token and at least one reference. The at least one reference could be a device serial number, a networking MAC address, or a membership ID reference from a web service. Access to the data source is also managed with a plurality of secondary enablers.

**30 Claims, 7 Drawing Sheets**

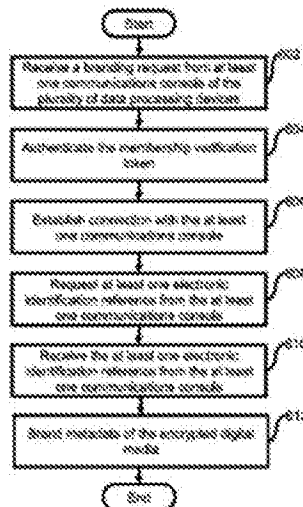

**US 8,533,860 B1**

Page 2

(56)

**References Cited**

**OTHER PUBLICATIONS**

Co-pending U.S. Appl. No. 13/397,517 document reference: Nov. 26, 2012.

Co-pending U.S. Appl. No. 13/397,517, document reference: Nov. 26, 2012.

Liu et al. 2004 NPL.—A License-sharing scheme in Digital Rights Management.

Co-pending U.S. Appl. No. 13/397,517 document reference: Nov. 26, 2012 Index of Claims.

Co-pending U.S. Appl. No. 13/397,517 document reference: Nov. 26, 2012 Examiner's search strategy and results.

Co-pending U.S. Appl. No. 13/397,517 document reference: Nov. 26, 2012 Non Patent Literature—Baiya et al. U.S. Appl. No. 61/307,196.

Co-pending U.S. Appl. No. 13/397,517 document reference: Nov. 26, 2012 Search information including classification, databases and other search related notes.

Co-pending U.S. Appl. No. 13/397,517 document reference: May 31, 2012 Non-Final Rejection.

Co-pending U.S. Appl. No. 13/397,517 document reference: May 31, 2012.

Co-pending U.S. Appl. No. 13/397,517 document reference: May 31, 2012 Index of Claims.

Co-pending U.S. Appl. No. 13/397,517 document reference: May 31, 2012 Examiner's search strategy and results.

Co-pending U.S. Appl. No. 13/397,517 document reference: May 31, 2012 Bibliographic Data Sheet.

Co-pending U.S. Appl. No. 13/397,517 document reference May 31, 2012 Search information including classification, databases and other search related notes.

Co-pending U.S. Appl. No. 13/397,517 document reference Feb. 4, 2013 Notice of Allowance and Fees Due (PTOL-85).

Co-pending U.S. Appl. No. 13/397,517 document reference: Feb. 4, 2013 Examiner initiated interview summary (PTOL-413B).

Co-pending U.S. Appl. No. 13/397,517 document reference: Feb. 4, 2013 Examiner's Amendment and Detailed Action.

Co-pending U.S. Appl. No. 13/397,517 document reference: Feb. 4, 2013 Issue Information including classification, examiner, name, claim, renumbering, etc.

Co-pending U.S. Appl. No. 13/397,517 document reference: Feb. 4, 2013.

Co-pending U.S. Appl. No. 13/397,517 document reference: Feb. 4, 2013 Index of Claims.

Co-pending U.S. Appl. No. 13/397,517 document reference: Feb. 4, 2013 Search information including classification, databases and other search related notes.

Co-pending U.S. Appl. No. 13/397,517 document reference: Feb. 4, 2013 Examiner's search strategy and results.

\* cited by examiner



US008402555B2

(12) **United States Patent**  
**Grecia**

(10) **Patent No.:** **US 8,402,555 B2**  
(45) **Date of Patent:** **Mar. 19, 2013**

(54) **PERSONALIZED DIGITAL MEDIA ACCESS SYSTEM (PDMA)**

(76) **Inventor:** William Grecia, Grandville, MI (US)

(\* ) **Notice:** Subject to any disclaimer, the term of this patent is extended or adjusted under 35 U.S.C. 154(b) by 0 days.

(21) **Appl. No.:** 13/397,517

(22) **Filed:** Feb. 15, 2012

(65) **Prior Publication Data**

US 2012/0151220 A1 Jun. 14, 2012

5,883,955 A	3/1999	Roaming	
5,887,060 A	3/1999	Roaming	
5,903,647 A	5/1999	Roaming	
5,907,617 A	5/1999	Roaming	
6,385,596 B1	5/2002	Wiser	
6,611,812 B2	8/2003	Hurtado	
6,665,797 B1	12/2003	Keung	
6,799,165 B1	9/2004	Boesjes	
7,254,235 B2 *	8/2007	Boudrenault et al.	380/239
7,266,839 B2	9/2007	Bowers et al.	
7,290,699 B2	11/2007	Roddy	
7,340,769 B2	3/2008	Baughner	
7,343,014 B2 *	3/2008	Sorio et al.	380/278
7,386,513 B2	6/2008	Lao	
7,515,710 B2	4/2009	Gisub	
7,516,495 B2	4/2009	Shoemaker	
7,526,650 B1 *	4/2009	Wimmer	713/176

(Continued)

**Related U.S. Application Data**

(63) Continuation of application No. 12/985,351, filed on Jan. 6, 2011, which is a continuation of application No. 12/728,218, filed on Mar. 21, 2010, now abandoned.

(51) **Int. Cl.**  
*H04L 29/06* (2006.01)

(52) **U.S. Cl.** ..... 726/29; 726/28; 713/185

(58) **Field of Classification Search** ..... 726/1-21, 726/26-33; 713/155-159, 168, 172-176, 713/185, 182

See application file for complete search history.

(56) **References Cited**

**U.S. PATENT DOCUMENTS**

5,010,571 A	4/1991	Katznelson
5,247,575 A	9/1993	Sprague
5,267,313 A	11/1993	Hirata
5,319,705 A	6/1994	Haber
5,349,642 A	9/1994	Kingdon
5,598,074 A	4/1996	Chaudhury
5,586,186 A	12/1996	Yurval
5,719,938 A	2/1998	Haas
5,737,416 A	4/1998	Cooper
5,870,543 A	2/1999	Roaming
5,883,954 A	3/1999	Roaming

**FOREIGN PATENT DOCUMENTS**

EP	1505530 A1	2/2005
EP	1564621 A1	8/2005

(Continued)

**OTHER PUBLICATIONS**

Liu et al. 2004 NPL—A license-sharing scheme in Digital Rights Management.\*

(Continued)

*Primary Examiner* — Jung Kim  
*Assistant Examiner* — Tri Tran

(57) **ABSTRACT**

The invention is an apparatus that facilitates access to encrypted digital media to accept verification and authentication from an excelsior enabler using at least one token and at least one electronic identification. The at least one electronic identification could be a device serial number, a networking MAC address, or a membership ID reference from a web service. Access to the product is also managed with a plurality of secondary enablers using the at least one electronic identification reference.

26 Claims, 7 Drawing Sheets

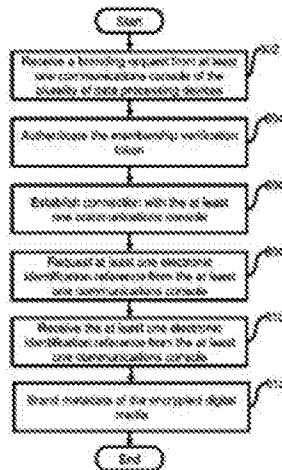

## US 8,402,555 B2

Page 2

## U.S. PATENT DOCUMENTS

7,567,987	B2	7/2009	Shappell et al.	
7,568,111	B2	7/2009	Alve	
7,571,328	B2	8/2009	Baumert	
7,594,273	B2	9/2009	Zhu	
7,610,639	B2	10/2009	Ji	
7,624,417	B2	11/2009	Duu	
7,634,734	B2	12/2009	Fuller et al.	
7,689,823	B2	3/2010	Shen	
7,702,892	B2	4/2010	Taylor	
8,250,145	B2	8/2012	Zuckerberg	
8,280,959	B1	10/2012	Zuckerberg	
2002/0010759	A1	1/2002	Hanson	
2002/0157002	A1	10/2002	Messerges	
2003/0018491	A1	1/2003	Nakashima	
2003/0051149	A1	3/2003	Robert	
2003/0220880	A1	11/2003	Lao	
2004/0024670	A1	2/2004	Valenzuela	
2004/0062400	A1	4/2004	Socio	
2004/0162786	A1	8/2004	Cross	
2004/0220878	A1	11/2004	Lao	
2005/0065891	A1*	3/2005	Lee et al.	705/59
2005/0066353	A1	3/2005	Franzoni	
2005/0138406	A1	6/2005	Cox	
2005/0182727	A1	8/2005	Robert	
2005/0182931	A1	8/2005	Robert	
2005/0198510	A1	9/2005	Robert	
2005/0216752	A1	9/2005	Robert	
2006/0076554	A1	2/2006	Schrock	
2006/0173787	A1	6/2006	Weber	
2006/0173789	A1	8/2006	Baumert	
2006/0259852	A1	11/2006	Upendran	
2006/0259982	A1	11/2006	Upendran	
2007/0010334	A1	1/2007	Muller	
2007/0055887	A1	3/2007	Cross	
2007/0156719	A1	7/2007	Upendran	
2007/0179854	A1	8/2007	Ziv	
2007/0180483	A1	8/2007	Duu	
2007/0250445	A1	10/2007	Ache	
2007/0266095	A1	11/2007	Billaus et al.	
2008/0010685	A1*	1/2008	Holtzman et al.	726/27
2008/0027869	A1	1/2008	Kalkreuth	
2008/0091606	A1	4/2008	Garcia	
2008/0109911	A1	5/2008	Tedesco	
2008/0114992	A1	5/2008	Robert	
2008/0137809	A1	6/2008	Robert	
2008/0165956	A1	7/2008	Zhu	
2008/0209576	A1	8/2008	Nooning	
2009/0012805	A1	1/2009	Schnell	
2009/0049856	A1	2/2009	Vielink	
2009/0083541	A1*	3/2009	Levine	713/165
2009/0086975	A1	4/2009	Robert	
2009/0089884	A1	4/2009	Robert	
2009/0106060	A1	4/2009	Livnat et al.	
2009/0106850	A1	4/2009	Robert	
2009/0164776	A1	6/2009	Turrisiani	
2009/0183010	A1	7/2009	Schnell	
2009/0217036	A1	8/2009	Irsin	
2009/0254930	A1	10/2009	Lo	
2009/0257591	A1	10/2009	Mihal	
2009/0265278	A1	10/2009	Wang	
2009/0299903	A1	12/2009	Pippus	
2009/0307078	A1	12/2009	Mihal	
2009/0327702	A1	12/2009	Schnell	
2009/0328228	A1	12/2009	Schnell	
2010/0027796	A1	2/2010	Robert	
2010/0043077	A1	2/2010	Robert	
2010/0057527	A1	3/2010	Robert	
2010/0097871	A1	3/2010	Kaplan	
2010/0106099	A1*	4/2010	Bradbury et al.	725/29
2010/0299264	A1	11/2010	Berger et al.	
2011/0145896	A1	6/2011	Berger	
2011/0208695	A1	8/2011	Anand	
2011/0263137	A1	10/2011	Myder	
2011/0288946	A1*	11/2011	Baiya et al.	705/26.1
2011/0313898	A1	12/2011	Singhal	
2011/0320345	A1	12/2011	Taveau	
2012/0036291	A1	2/2012	Silver	
2012/0036041	A1	2/2012	Hesseliak	

2012/0041029	A1	2/2012	Rothschild
2012/0066652	A1	3/2012	Robert
2012/0079095	A1	3/2012	Evans
2012/0079126	A1	3/2012	Evans
2012/0079276	A1	3/2012	Evans
2012/0079606	A1	3/2012	Evans
2012/0095871	A1	4/2012	Dorsey
2012/0095906	A1	4/2012	Dorsey
2012/0095916	A1	4/2012	Dorsey
2012/0124610	A1	5/2012	Shimani
2012/0124611	A1	5/2012	Shimani
2012/0124612	A1	5/2012	Adimatyam
2012/0124613	A1	5/2012	Roddy
2012/0124614	A1	5/2012	Shimani
2012/0124678	A1	5/2012	Shimani
2012/0130903	A1	5/2012	Dorsey
2012/0150727	A1	6/2012	Nuzzo
2012/0160333	A1	6/2012	van Bühren
2012/0173333	A1	7/2012	Berger
2012/0173431	A1	7/2012	Bichie
2012/0173625	A1	7/2012	Berger
2012/0191553	A1	7/2012	Sathe
2012/0254340	A1	10/2012	Velumnylum
2012/0255033	A1	10/2012	Dwivedi
2012/0290376	A1	11/2012	Dryer
2012/0290741	A1	11/2012	Dykes
2012/0310828	A1	12/2012	Bu
2013/0007892	A1	1/2013	Inooka

## FOREIGN PATENT DOCUMENTS

JP	2007-183935	A	7/2007
KR	10-2004-0107602	A	12/2004
KR	10-2005-0028244	A	3/2005
KR	10-2005-0060685	A	6/2005
KR	10-0768203	B1	4/2007
WO	2008/111052	A2	9/2008

## OTHER PUBLICATIONS

Simon I. Garfinkel, "Email-Based Identification and Authentication: An Alternative to PKI", IEEE Security & Privacy, <http://computer.org/security/>, published Nov. 2003, pp. 20-26.

Video Interview—Title: Mitch Singer, Sony Pictures—Publication Source: Youtube.com [URL: <http://youtu.be/nqf8kADFR>]—(Internet Publication Jun. 24, 2008) Note: Attached URL for Media NPL Reference.

Video Interview—Title: Jeff Bowker and Brian Roberts discuss the TV Everywhere model and upcoming trial on Comcast—Publication Source: Youtube.com [URL: <http://youtu.be/q8R9dIV9I>]—(Internet Publication Jun. 25, 2009) Note: Attached URL for Media NPL Reference.

Author: William Garcia (patent applicant)—Publication Source: Amazon Web Services Products and Solutions Catalog—Title: STREAM Digital Distribution System (UltraViolet—Keychest)—Internet Publication: <http://aws.amazon.com/customers/gps/2621> [Publication date: Jun. 22, 2009].

Author: Nicholas Deleon—Publication Source: TechCrunch—Title: Movie studios launch Epix: 720p streaming video for free—Internet Publication: <http://techcrunch.com/2009/06/08/movie-studios-launch-epix-720p-streaming-video-for-free/> [Publication date: Jun. 8, 2009].

Author: Matt Burns—Publication Source: TechCrunch—Title: TV Everywhere is Comcast and Time Warner's answer to free internet video—Internet Publication: <http://techcrunch.com/2009/06/24/te-everywhere-is-comcast-and-time-warner-s-answer-to-free-internet-video/> [Publication date: Jun. 24, 2009].

Author: Michael Arrington—Movie Labels to Launch New "Open Market" Play Anywhere Scheme As Last Ditch Effort to Save DRM—Publication Source: TechCrunch.com [URL: <http://techcrunch.com/2008/08/26/movie-labels-to-launch-new-open-market-play-anywhere-scheme-as-last-ditch-effort-to-save-drm/>]—(Internet Publication Aug. 26, 2008).

Author: Mitch Singer—Developing the Digital Market—Publication Source: TechCrunch.com [URL: <http://techcrunch.files.wordpress.com/2008/08/singer.pdf>]—(Internet Publication Aug. 26, 2008).

EWS-003428

## US 8,402,555 B2

Page 3

- Author: Brian Fox—Title: DECE UltraViolet Response to STREEM Licensing Offer—Internet Publication: <http://www.doestoc.com/docs/100643534/DECE-Note/> [Publication date: Oct. 25, 2011]. Abandoned USPTO U.S. Appl. No. 61/303,292 (evidence to overcome examiner's last rejection in accordance with MPEP 2142).
- Author—Preston Gralla—Digital River Launches DRM Solution for Software Publishers—Publication Source: [informationweek.com](http://www.informationweek.com) [URL: <http://www.informationweek.com/news/18901739/>]—(Internet Publication Date: Apr. 15, 2004).
- Author—Digital River Corporation—Digital River Announces New Digital Rights Management Service—Publication Source: [digitalriver.com](http://www.digitalriver.com) [URL: [http://www.digitalriver.com/corporate/press\\_releases/pr\\_328.shtml](http://www.digitalriver.com/corporate/press_releases/pr_328.shtml)]—(Internet Publication Date: Jul. 14, 2003).
- Author—Digital River Corporation—Digital River SoftwarePassport Copyright Software—Publication Source: [silicomrealms.com](http://www.silicomrealms.com) [URL: <http://www.silicomrealms.com/>]—(Internet Publication): Aug. 26, 2010.
- Internet publication: Nook Color LendMe [www.barnesandnoble.com/](http://www.barnesandnoble.com/), Jan. 21, 2011.
- Internet publication: Coral consortium "Scenario" [www.coral-interop.org](http://www.coral-interop.org), Feb. 27, 2006.
- Author—Wikipedia Org.—Steam (software)—Publication Source: [wikipedia.org](http://en.wikipedia.org/wiki/Steam_(software)) [URL: [http://en.wikipedia.org/wiki/Steam\\_\(software\)](http://en.wikipedia.org/wiki/Steam_(software))]—(Internet Publication Date: Aug. 13, 2004).
- Author—William Grecia—STREEM Windows Java C++ written code copyright and support documentation—Publication Source: [strem.com](http://www.strem.com) [URL: <http://www.strem.com/>]—(Software Copyright Publication Date and Invention Reduced to Practice: Sep. 3, 2009).
- Author—William Grecia—Next Generation Digital Delivery STREEM Ecosystem Replaces DVD and Blu-Ray—Publication Source: [mi2n.com](http://mi2n.com) [URL: [http://mi2n.com/press.php?press\\_nb=130517](http://mi2n.com/press.php?press_nb=130517)]—(Internet Publication Date: May 28, 2010).
- Author—Facebook Corporation—Graph API documentation—Publication Source: [facebook.com](http://developers.facebook.com/docs/api/) [URL: <http://developers.facebook.com/docs/api/>]—(Internet Publication Update: Apr. 21, 2010).
- Author—Amazon Inc.—Amazon Web Services API documentation—Publication Source: [URL: <http://aws.amazon.com/>]—(Internet Publication), Jul. 16, 2002.
- Author—Rick Merritt—Analysis: Hollywood's next digital media gambit—Publication Source: [ociimes.com](http://www.ociimes.com) [URL: <http://www.ociimes.com/design/audio-design/4005862/Analysis-Hollywood-s-next-digital-media-gambit/>]—(Internet Publication Date: Nov. 2, 2008).
- Author—Ethan Smith—Disney Touts a Way to Ditch the DVD—Publication Source: [Wall Street Journal Online](http://online.wsj.com/article/NA_WSJ...) [URL: [http://online.wsj.com/article/NA\\_WSJ...](http://online.wsj.com/article/NA_WSJ...)]. PUBLISHED: 424052748703916204575585650026945222.html—(Internet Publication Date: Sep. 21, 2009).
- Author—Nada Ulaby—Introducing UltraViolet. Buy Your Digital Movie Once, Play It Anywhere?—Publication Source: [NPR Online](http://www.npr.org) [URL: <http://www.npr.org/blogs/monkeysee/2010/07/19/128626624/introducing-ultraviolet-buy-your-movie-once-play-it-anywhere/>]—(Internet Publication Date: Jul. 20, 2010).
- Author—William Grecia—The Retail Zip Company Releases Secure Electronic Media Format STREEM to Replace DVD and Blu-ray—Publication Source: [mi2n.com](http://mi2n.com) [URL: [http://mi2n.com/press.php?press\\_nb=1122843](http://mi2n.com/press.php?press_nb=1122843)]—(Internet Publication Date: Sep. 3, 2009).
- Author—Apple Corporation—(iTunes application copyright—Publication Source: [apple.com](http://apple.com) [URL: [www.apple.com/itunes/](http://www.apple.com/itunes/)]—(Copyright Publication Date: Jan. 9, 2011).
- Author—Microsoft Corporation—Zune application copyright—Publication Source: [zune.net](http://zune.net) [URL: [www.zune.net/](http://www.zune.net/)]—(Copyright Publication Date: Nov. 14, 2006).
- Author—Netflix Corporation—Netflix application copyright—Publication Source: [netflix.com](http://netflix.com) [URL: [www.netflix.com/](http://www.netflix.com/)]—(Copyright Publication), Jan. 15, 2007.
- Author—Best Buy Corporation—CinemaNow application copyright—Publication Source: [cinemanow.com](http://cinemanow.com) [URL: [www.cinemanow.com/](http://www.cinemanow.com/)]—(Copyright Publication), May 18, 2010.
- Author—Best Buy Corporation—Napster application copyright—Publication Source: [napster.com](http://napster.com) [URL: [www.napster.com/](http://www.napster.com/)]—(Copyright Publication), May 1, 2006.
- Author—Google Corporation—YouTube application copyright—Publication Source: [youtube.com](http://youtube.com) [URL: [www.youtube.com/](http://www.youtube.com/)]—(Copyright Publication), Feb. 14, 2005.
- Author—Wal-Mart Corporation—Vudu application copyright—Publication Source: [vudu.com](http://vudu.com) [URL: [www.vudu.com/](http://www.vudu.com/)]—(Copyright Publication), Sep. 6, 2007.
- Author—Connected Media Experience Org.—CMX specification—Publication Source: [connectedmediaexperience.org](http://connectedmediaexperience.org) [URL: [www.connectedmediaexperience.org/technicaloverview.html](http://www.connectedmediaexperience.org/technicaloverview.html)]—(Internet Publication), Jan. 27, 2009.
- Author—SMPTE Org.—Digital Cinema DCP MXF specifications—Publication Source: [smpste.org](http://www.smpste.org) [URL: [www.smpste.org/standards/](http://www.smpste.org/standards/)]—(Internet Publication), Oct. 8, 2002.
- Author—Wikipedia Org.—Xbox Live Marketplace and Zune Marketplace—Publication Source: [wikipedia.org](http://en.wikipedia.org/wiki/Xbox_Live_Marketplace_and_Zune_Marketplace) [URL: [http://en.wikipedia.org/wiki/Xbox\\_Live\\_Marketplace\\_and\\_Zune\\_Marketplace](http://en.wikipedia.org/wiki/Xbox_Live_Marketplace_and_Zune_Marketplace)]—(Internet Publication), Jan. 18, 2006.
- Author—Dan Franks—First Look: iTunes Digital Copy—Publication Source: [macworld.com](http://macworld.com) [URL: [www.macworld.com/article/131751/2008/01/digitalcopy.html](http://www.macworld.com/article/131751/2008/01/digitalcopy.html)]—(Internet Publication Jan. 22, 2008).
- Author—Rich Fiscus—Review: Is DVD Digital Copy worth the trouble?—Publication Source: [alledawn.com](http://www.alledawn.com) [URL: [www.alledawn.com/news/article.cfm/2009/11/18/review\\_is\\_dvd\\_digital\\_copy\\_worth\\_the\\_trouble/](http://www.alledawn.com/news/article.cfm/2009/11/18/review_is_dvd_digital_copy_worth_the_trouble/)]—(Internet Publication Nov. 18, 2009).
- Author—Wikipedia Org.—Digital rights management—Publication Source: [wikipedia.org](http://en.wikipedia.org/wiki/Digital_Rights_Management) [URL: [http://en.wikipedia.org/wiki/Digital\\_Rights\\_Management](http://en.wikipedia.org/wiki/Digital_Rights_Management)]—(Internet Publication), Sep. 22, 2002.
- Author—Wikipedia Org.—Application programming interface—Publication Source: [wikipedia.org](http://en.wikipedia.org/wiki/API) [URL: <http://en.wikipedia.org/wiki/API>]—(Internet Publication), Jul. 30, 2001.
- Author—Wikipedia Org.—Steam (content delivery)—Publication Source: [wikipedia.org](http://en.wikipedia.org/wiki/Steam_(content_delivery)) [URL: [http://en.wikipedia.org/wiki/Steam\\_\(content\\_delivery\)](http://en.wikipedia.org/wiki/Steam_(content_delivery))]—(Internet Publication), Sep. 13, 2004.
- Author—Ben Druswongh—Disney's KeyChest is not DRM—Publication Source: [engadget.com](http://engadget.com) [URL: [www.engadget.com/2010/01/16/disneys-keychest-is-not-drm/](http://www.engadget.com/2010/01/16/disneys-keychest-is-not-drm/)]—(Internet Publication Jan. 16, 2010).
- Author—Richard Lawler—DECE & Keychest both laying claim to friendly DRM of the future title—Publication Source: [engadget.com](http://engadget.com) [URL: [www.engadget.com/2010/01/06/dece-and-keychain-both-laying-claim-to-friendly-drm-of-the-future/](http://www.engadget.com/2010/01/06/dece-and-keychain-both-laying-claim-to-friendly-drm-of-the-future/)]—(Internet Publication Jan. 6, 2010).

\* cited by examiner

AO 120 (Rev. 08/10)

<b>TO:</b> <b>Mail Stop 8</b> <b>Director of the U.S. Patent and Trademark Office</b> <b>P.O. Box 1450</b> <b>Alexandria, VA 22313-1450</b>	<b>REPORT ON THE</b> <b>FILING OR DETERMINATION OF AN</b> <b>ACTION REGARDING A PATENT OR</b> <b>TRADEMARK</b>
--	---

In Compliance with 35 U.S.C. § 290 and/or 15 U.S.C. § 1116 you are hereby advised that a court action has been filed in the U.S. District Court Northern District of Illinois on the following

Trademarks or  Patents. (  the patent action involves 35 U.S.C. § 292.):

DOCKET NO. 1:16-cv-10216	DATE FILED 11/1/2016	U.S. DISTRICT COURT Northern District of Illinois
PLAINTIFF William Grecia		DEFENDANT Fox Entertainment Group, Inc.
PATENT OR TRADEMARK NO.	DATE OF PATENT OR TRADEMARK	HOLDER OF PATENT OR TRADEMARK
1 8,533,860 B1	9/10/2013	William Grecia
2 8,402,555 B2	3/19/2013	William Grecia
3		
4		
5		

In the above—entitled case, the following patent(s)/ trademark(s) have been included:

DATE INCLUDED	INCLUDED BY <input type="checkbox"/> Amendment <input type="checkbox"/> Answer <input type="checkbox"/> Cross Bill <input type="checkbox"/> Other Pleading	
PATENT OR TRADEMARK NO.	DATE OF PATENT OR TRADEMARK	HOLDER OF PATENT OR TRADEMARK
1		
2		
3		
4		
5		

In the above—entitled case, the following decision has been rendered or judgement issued:

DECISION/JUDGEMENT
--------------------

CLERK Thomas G. Bruton	(BY) DEPUTY CLERK Kerwin Posley	DATE 11/1/2016
---------------------------	------------------------------------	-------------------

Copy 1—Upon initiation of action, mail this copy to Director Copy 3—Upon termination of action, mail this copy to Director  
 Copy 2—Upon filing document adding patent(s), mail this copy to Director Copy 4—Case file copy

EWS-003430



TO: **Mail Stop 8**  
**Director of the U.S. Patent & Trademark Office**  
**P.O. Box 1450**  
**Alexandria, VA 22313-1450**

**REPORT ON THE  
FILING OR DETERMINATION OF AN  
ACTION REGARDING A PATENT OR  
TRADEMARK**

In Compliance with 35 § 290 and/or 15 U.S.C. § 1116 you are hereby advised that a court action has been filed in the U.S. District Court Northern District of California on the following:

Patents or  Trademarks

DOCKET NO:  
16-cv-06283-SK

DATE FILED:  
October 31, 2016

UNITED STATES DISTRICT COURT  
Phillip Burton Federal Building  
450 Golden Gate Avenue  
San Francisco, CA 94102

PLAINTIFF:  
Grecia

DEFENDANT:  
Adobe Systems Incorporated

PATENT OR TRADEMARK NO.	DATE OF PATENT OR TRADEMARK	HOLDER OF PATENT OR TRADEMARK
1.US8,533,860 B1	Sept. 10, 2013	William Grecia
2.US8,402,555 B2	Mar. 19, 2013	William Grecia
3.		
4.		
5.		

In the above-entitled case, the following patent(s) have been included.

DATE INCLUDED INCLUDED BY:  
 Amendment  Answer  Cross Bill  Other Pleading

PATENT OR TRADEMARK NO.	DATE OF PATENT OR TRADEMARK	HOLDER OF PATENT OR TRADEMARK
1.		
2.		
3.		
4.		
5.		

In the above-entitled case, the following decision has been rendered or judgment issued:

DECISION/JUDGEMENT:

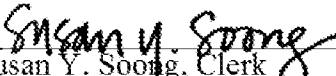
  
Susan Y. Soong, Clerk

  
(by) Deputy Clerk, Yumiko Saito

- Copy 1 – Upon initiation of action, mail this copy to Commissioner
- Copy 2 – Upon filing document adding patent(s) mail this copy to Commissioner
- Copy 3 – Upon termination of action, mail this copy to the Commissioner
- Copy 4 – Case file copy

AO 120 (Rev. 08/10)

<b>TO: Mail Stop 8</b> <b>Director of the U.S. Patent and Trademark Office</b> <b>P.O. Box 1450</b> <b>Alexandria, VA 22313-1450</b>	<b>REPORT ON THE</b> <b>FILING OR DETERMINATION OF AN</b> <b>ACTION REGARDING A PATENT OR</b> <b>TRADEMARK</b>
---	---

In Compliance with 35 U.S.C. § 290 and/or 15 U.S.C. § 1116 you are hereby advised that a court action has been filed in the U.S. District Court Northern District of Illinois on the following

Trademarks or  Patents. (  the patent action involves 35 U.S.C. § 292.):

DOCKET NO. 16cv10211	DATE FILED 10/31/2016	U.S. DISTRICT COURT Northern District of Illinois
PLAINTIFF William Grecia		DEFENDANT Big Ten Network Services, LLC
PATENT OR TRADEMARK NO.	DATE OF PATENT OR TRADEMARK	HOLDER OF PATENT OR TRADEMARK
1 8533860		
2 8402555		
3		
4		
5		

In the above—entitled case, the following patent(s)/ trademark(s) have been included:

DATE INCLUDED	INCLUDED BY <input type="checkbox"/> Amendment <input type="checkbox"/> Answer <input type="checkbox"/> Cross Bill <input type="checkbox"/> Other Pleading	
PATENT OR TRADEMARK NO.	DATE OF PATENT OR TRADEMARK	HOLDER OF PATENT OR TRADEMARK
1		
2		
3		
4		
5		

In the above—entitled case, the following decision has been rendered or judgement issued:

DECISION/JUDGEMENT
--------------------

CLERK Thomas G. Bruton	(BY) DEPUTY CLERK Brook Gudausky	DATE 3/9/2017
---------------------------	-------------------------------------	------------------

Copy 1—Upon initiation of action, mail this copy to Director Copy 3—Upon termination of action, mail this copy to Director  
 Copy 2—Upon filing document adding patent(s), mail this copy to Director Copy 4—Case file copy

EWS-003432



US008533860B1

(12) **United States Patent**  
Grecia

(10) **Patent No.:** US 8,533,860 B1  
(45) **Date of Patent:** \*Sep. 10, 2013

(54) **PERSONALIZED DIGITAL MEDIA ACCESS SYSTEM—PDMAS PART II**

(71) Applicant: **William Grecia, Brooklyn, NY (US)**

(72) Inventor: **William Grecia, Brooklyn, NY (US)**

(\* ) Notice: Subject to any disclaimer, the term of this patent is extended or adjusted under 35 U.S.C. 154(b) by 0 days.

This patent is subject to a terminal disclaimer.

(21) Appl. No.: **13/740,086**

(22) Filed: **Jan. 11, 2013**

(51) **Int. Cl.**  
**H04L 29/06** (2006.01)

(52) **U.S. Cl.**  
USPC ..... **726/29; 725/28; 713/185; 705/51**

(58) **Field of Classification Search**  
None  
See application file for complete search history.

2012/0041829	A1	2/2012	Rothschild
2012/0079099	A1	3/2012	Evans
2012/0079126	A1	3/2012	Evans
2012/0079276	A1	3/2012	Evans
2012/0079606	A1	3/2012	Evans
2012/0095871	A1	4/2012	Dorsey
2012/0095906	A1	4/2012	Dorsey
2012/0095916	A1	4/2012	Dorsey
2012/0130903	A1	5/2012	Dorsey
2012/0150727	A1	6/2012	Nuzzi
2012/0166333	A1	6/2012	Von Behren
2012/0173333	A1	7/2012	Berger
2012/0173431	A1	7/2012	Ritchie
2012/0173625	A1	7/2012	Berger
2012/0191553	A1	7/2012	Sathe
2012/0254340	A1	10/2012	Vehumyllum
2012/0255033	A1	10/2012	Dwivedi
2012/0290376	A1	11/2012	Dryer
2012/0298741	A1	11/2012	Dykes
2012/0310828	A1	12/2012	Hu
2013/0007892	A1	1/2013	Iaooka

**OTHER PUBLICATIONS**

Co-pending U.S. Appl. No. 13/397,517 document reference: Jan. 7, 2013 Examiner initiated interview summary (PTOL-413B).  
Co-pending U.S. Appl. No. 13/397,517 document reference: Dec. 26, 2012 Advisory Action (PTOL-303).  
Co-pending U.S. Appl. 13/397,517 document reference: Nov. 26, 2012 Final Rejection.

(56) **References Cited**

(Continued)

**U.S. PATENT DOCUMENTS**

7,254,235	B2	8/2007	Boudrenault et al.
7,343,014	B2	3/2008	Sovio et al.
7,526,650	B1*	4/2009	Wimmer ..... 713/176
8,250,145	B2	8/2012	Zuckerberg
8,280,959	B1	10/2012	Zuckerberg
2005/0665891	A1	3/2005	Lee et al.
2008/0010685	A1	1/2008	Holtzman et al.
2009/0083541	A1	3/2009	Levine
2010/0100899	A1	4/2010	Bradbury et al.
2011/0208695	A1	8/2011	Anand
2011/0265157	A1	10/2011	Ryder
2011/0288946	A1*	11/2011	Baiya et al. .... 705/26.1
2011/0313898	A1	12/2011	Singhal
2011/0320345	A1	12/2011	Taveau

*Primary Examiner* — Jung Kim  
*Assistant Examiner* — Tri Tran

(57) **ABSTRACT**

The invention is an apparatus that facilitates access to a data source to accept verification and authentication from an enabler using at least one token and at least one reference. The at least one reference could be a device serial number, a networking MAC address, or a membership ID reference from a web service. Access to the data source is also managed with a plurality of secondary enablers.

**30 Claims, 7 Drawing Sheets**

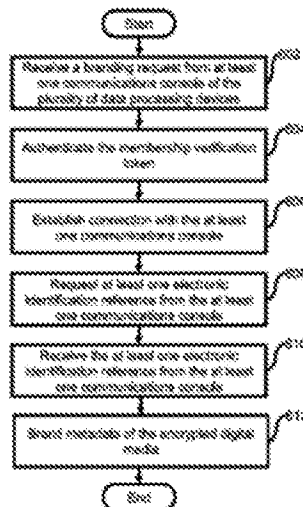

**US 8,533,860 B1**

Page 2

(56)

**References Cited**

**OTHER PUBLICATIONS**

Co-pending U.S. Appl. No. 13/397,517 document reference: Nov. 26, 2012.

Co-pending U.S. Appl. No. 13/397,517, document reference: Nov. 26, 2012.

Liu et al. 2004 NPL—A License-sharing scheme in Digital Rights Management.

Co-pending U.S. Appl. No. 13/397,517 document reference: Nov. 26, 2012 Index of Claims.

Co-pending U.S. Appl. No. 13/397,517 document reference: Nov. 26, 2012 Examiner's search strategy and results.

Co-pending U.S. Appl. No. 13/397,517 document reference: Nov. 26, 2012 Non Patent Literature—Baiya et al. U.S. Appl. No. 61/307,196.

Co-pending U.S. Appl. No. 13/397,517 document reference: Nov. 26, 2012 Search information including classification, databases and other search related notes.

Co-pending U.S. Appl. No. 13/397,517 document reference: May 31, 2012 Non-Final Rejection.

Co-pending U.S. Appl. No. 13/397,517 document reference: May 31, 2012.

Co-pending U.S. Appl. No. 13/397,517 document reference: May 31, 2012 Index of Claims.

Co-pending U.S. Appl. No. 13/397,517 document reference: May 31, 2012 Examiner's search strategy and results.

Co-pending U.S. Appl. No. 13/397,517 document reference: May 31, 2012 Bibliographic Data Sheet.

Co-pending U.S. Appl. No. 13/397,517 document reference May 31, 2012 Search information including classification, databases and other search related notes.

Co-pending U.S. Appl. No. 13/397,517 document reference Feb. 4, 2013 Notice of Allowance and Fees Due (PTOL-85).

Co-pending U.S. Appl. No. 13/397,517 document reference: Feb. 4, 2013 Examiner initiated interview summary (PTOL-413B).

Co-pending U.S. Appl. No. 13/397,517 document reference: Feb. 4, 2013 Examiner's Amendment and Detailed Action.

Co-pending U.S. Appl. No. 13/397,517 document reference: Feb. 4, 2013 Issue Information including classification, examiner, name, claim, renumbering, etc.

Co-pending U.S. Appl. No. 13/397,517 document reference: Feb. 4, 2013.

Co-pending U.S. Appl. No. 13/397,517 document reference: Feb. 4, 2013 Index of Claims.

Co-pending U.S. Appl. No. 13/397,517 document reference: Feb. 4, 2013 Search information including classification, databases and other search related notes.

Co-pending U.S. Appl. No. 13/397,517 document reference: Feb. 4, 2013 Examiner's search strategy and results.

\* cited by examiner



(12) **United States Patent**  
**Grecia**

(10) **Patent No.:** **US 8,402,555 B2**  
(45) **Date of Patent:** **Mar. 19, 2013**

(54) **PERSONALIZED DIGITAL MEDIA ACCESS SYSTEM (PDMAS)**

(76) **Inventor:** William Grecia, Grandville, MI (US)

(\* ) **Notice:** Subject to any disclaimer, the term of this patent is extended or adjusted under 35 U.S.C. 154(b) by 0 days.

(21) **Appl. No.:** 13/397,517

(22) **Filed:** Feb. 15, 2012

(65) **Prior Publication Data**

US 2012/0151220 A1 Jun. 14, 2012

5,883,955 A	3/1999	Roaming	
5,887,060 A	3/1999	Roaming	
5,903,647 A	5/1999	Roaming	
5,907,617 A	5/1999	Roaming	
6,385,596 B1	5/2002	Wisser	
6,611,812 B2	8/2003	Hurtado	
6,665,797 B1	12/2003	Keung	
6,799,165 B1	9/2004	Boesjer	
7,254,235 B2 *	8/2007	Boudreau et al.	380/239
7,266,839 B2	9/2007	Bowers et al.	
7,290,699 B2	11/2007	Raddy	
7,340,769 B2	3/2008	Baughner	
7,343,014 B2 *	3/2008	Sovio et al.	380/278
7,386,513 B2	6/2008	Lau	
7,515,710 B2	4/2009	Grab	
7,816,495 B2	4/2009	Shoemaker	
7,526,650 B1 *	4/2009	Wimmer	713/176

(Continued)

**Related U.S. Application Data**

(63) Continuation of application No. 12/985,351, filed on Jan. 6, 2011, which is a continuation of application No. 12/728,218, filed on Mar. 21, 2010, now abandoned.

(51) **Int. Cl.**  
*H04L 29/06* (2006.01)

(52) **U.S. Cl.** ..... 726/29; 726/28; 713/185

(58) **Field of Classification Search** ..... 726/1-21, 726/26-33; 713/155-159, 168, 172-176, 713/185, 182

See application file for complete search history.

**FOREIGN PATENT DOCUMENTS**

EP	1505530 A1	2/2005
EP	1864621 A1	8/2005

(Continued)

**OTHER PUBLICATIONS**

Liu et al. 2004 NPL—A license-sharing scheme in Digital Rights Management.\*

(Continued)

*Primary Examiner* — Jung Kim  
*Assistant Examiner* — Tri Tran

(56) **References Cited**

**U.S. PATENT DOCUMENTS**

5,010,571 A	4/1991	Katznelson
5,247,575 A	9/1993	Sprague
5,267,313 A	11/1993	Hirata
5,319,705 A	6/1994	Haber
5,349,642 A	9/1994	Kingsdon
5,509,074 A	4/1996	Choudhury
5,586,186 A	12/1996	Yuval
5,719,938 A	2/1998	Haas
5,737,416 A	4/1998	Cooper
5,870,543 A	2/1999	Roaming
5,883,954 A	3/1999	Roaming

(57) **ABSTRACT**

The invention is an apparatus that facilitates access to encrypted digital media to accept verification and authentication from an excelsior enabler using at least one token and at least one electronic identification. The at least one electronic identification could be a device serial number, a networking MAC address, or a membership ID reference from a web service. Access to the product is also managed with a plurality of secondary enablers using the at least one electronic identification reference.

**26 Claims, 7 Drawing Sheets**

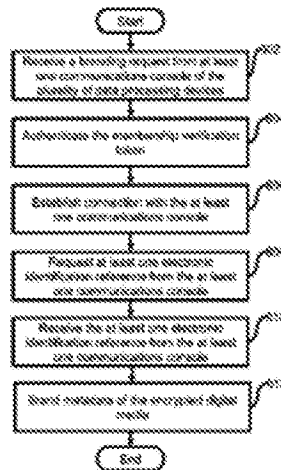

US 8,402,555 B2

Page 2

U.S. PATENT DOCUMENTS

7,567,987	B2	7/2009	Shappell et al.	
7,568,111	B2	7/2009	Alve	
7,571,328	B2	8/2009	Baumert	
7,594,275	B2	9/2009	Zhu	
7,610,639	B2	10/2009	Ji	
7,624,417	B2	11/2009	Duo	
7,634,734	B2	12/2009	Fuller et al.	
7,689,823	B2	3/2010	Shen	
7,702,892	B2	4/2010	Taggar	
8,250,145	B2	8/2012	Zuckenberg	
8,280,959	B1	10/2012	Zuckenberg	
2002/0018759	A1	1/2002	Hanson	
2002/0157002	A1	10/2002	Messerges	
2003/0018491	A1	1/2003	Nakahara	
2003/0051149	A1	3/2003	Robert	
2003/0228880	A1	11/2003	Lao	
2004/0024670	A1	2/2004	Valenzuela	
2004/0062400	A1	4/2004	Sovic	
2004/0162786	A1	8/2004	Cross	
2004/0228878	A1	11/2004	Lao	
2005/0065891	A1	3/2005	Lee et al.	705/59
2005/0066053	A1	3/2005	Franzdonk	
2005/0138406	A1	6/2005	Cox	
2005/0182727	A1	8/2005	Robert	
2005/0182931	A1	8/2005	Robert	
2005/0198510	A1	9/2005	Robert	
2005/0216752	A1	9/2005	Robert	
2006/0036554	A1	2/2006	Schrock	
2006/0173787	A1	8/2006	Weber	
2006/0173789	A1	8/2006	Baumert	
2006/0259852	A1	11/2006	Upendran	
2006/0259982	A1	11/2006	Upendran	
2007/0018334	A1	1/2007	Multerer	
2007/0055887	A1	3/2007	Cross	
2007/0156719	A1	7/2007	Upendran	
2007/0179854	A1	8/2007	Ziv	
2007/0180483	A1	8/2007	Duo	
2007/0259445	A1	10/2007	Ache	
2007/0266095	A1	11/2007	Billaus et al.	
2008/0010685	A1	1/2008	Holtzman et al.	726/27
2008/0027869	A1	1/2008	Kalkar	
2008/0091606	A1	4/2008	Grocia	
2008/0109911	A1	5/2008	Tedesco	
2008/0114992	A1	5/2008	Robert	
2008/0137869	A1	6/2008	Robert	
2008/0165956	A1	7/2008	Zhu	
2008/0209576	A1	8/2008	Nooning	
2009/0012805	A1	1/2009	Schnell	
2009/0049556	A1	2/2009	Vrieland	
2009/0083541	A1	3/2009	Levine	715/165
2009/0086975	A1	4/2009	Robert	
2009/0089884	A1	4/2009	Robert	
2009/0100660	A1	4/2009	Livnat et al.	
2009/0106850	A1	4/2009	Robert	
2009/0164776	A1	6/2009	Tuoriniemi	
2009/0183010	A1	7/2009	Schnell	
2009/0217836	A1	8/2009	Irwin	
2009/0254930	A1	10/2009	Lo	
2009/0257591	A1	10/2009	Mihal	
2009/0265278	A1	10/2009	Wang	
2009/0299963	A1	12/2009	Pippusi	
2009/0307978	A1	12/2009	Mihal	
2009/0327702	A1	12/2009	Schnell	
2009/0328228	A1	12/2009	Schnell	
2010/0027796	A1	2/2010	Robert	
2010/0043077	A1	2/2010	Robert	
2010/0057527	A1	3/2010	Robert	
2010/0097871	A1	3/2010	Kaplan	
2010/0100899	A1	4/2010	Smithary et al.	725/29
2010/0299264	A1	11/2010	Berger et al.	
2011/0145896	A1	6/2011	Berger	
2011/0208695	A1	8/2011	Anand	
2011/0263137	A1	10/2011	Kydar	
2011/0288946	A1	11/2011	Baiya et al.	705/26.1
2011/0313898	A1	12/2011	Singhal	
2011/0328345	A1	12/2011	Taveau	
2012/0036291	A1	2/2012	Silver	
2012/0036041	A1	2/2012	Hesseliak	

2012/0041829	A1	2/2012	Rothschild
2012/0066652	A1	3/2012	Robert
2012/0079095	A1	3/2012	Evans
2012/0079126	A1	3/2012	Evans
2012/0079276	A1	3/2012	Evans
2012/0079606	A1	3/2012	Evans
2012/0095871	A1	4/2012	Dorsey
2012/0095906	A1	4/2012	Dorsey
2012/0095916	A1	4/2012	Dorsey
2012/0124610	A1	5/2012	Shimani
2012/0124611	A1	5/2012	Shimani
2012/0124612	A1	5/2012	Adimatyam
2012/0124613	A1	5/2012	Roddy
2012/0124614	A1	5/2012	Shimani
2012/0124678	A1	5/2012	Shimani
2012/0130903	A1	5/2012	Dorsey
2012/0150727	A1	6/2012	Nisenz
2012/0160333	A1	6/2012	von Bahren
2012/0173333	A1	7/2012	Berger
2012/0173431	A1	7/2012	Richie
2012/0173625	A1	7/2012	Berger
2012/0191553	A1	7/2012	Sathe
2012/0254340	A1	10/2012	Velumnylum
2012/0255033	A1	10/2012	Dwivedi
2012/0290376	A1	11/2012	Dryer
2012/0296741	A1	11/2012	Dyhan
2012/0310828	A1	12/2012	Ho
2013/0007892	A1	1/2013	Inooka

FOREIGN PATENT DOCUMENTS

JP	2007-183935	A	7/2007
KR	10-2004-0107602	A	12/2004
KR	10-2005-0028244	A	3/2005
KR	10-2005-0060685	A	6/2005
KR	10-0768203	B1	4/2007
WO	2008/111052	A2	9/2008

OTHER PUBLICATIONS

Simon I. Garfinkel, "Email-Based Identification and Authentication: An Alternative to PKI?", IEEE Security & Privacy, <http://computer.org/security/>, published Nov. 2003, pp. 20-26.

Video Interview—Title: Mitch Singer, Sony Pictures—Publication Source: Youtube.com [URL: <http://youtu.be/nqf8kADFRU>]—(Internet Publication Jun. 24, 2008) Note: Attached URL for Media NPL Reference.

Video Interview—Title: Jeff Bowker and Brian Roberts discuss the TV Everywhere model and upcoming trial on Comcast—Publication Source: Youtube.com [URL: <http://youtu.be/g8R9idIV9I>]—(Internet Publication Jun. 25, 2009) Note: Attached URL for Media NPL Reference.

Author: William Grocia (patent applicant)—Publication Source: Amazon Web Services Products and Solutions Catalog—Title: STREAM Digital Distribution System (Ultraviolet—Keyches)—Internet Publication: <http://aws.amazon.com/customers/gps/2621> [Publication date: Jun. 22, 2009].

Author: Nicholas Deleon—Publication Source: TechCrunch—Title: Movie studios launch Epix: 720p streaming video for free—Internet Publication: <http://techcrunch.com/2009/06/08/movie-studios-launch-epix-720p-streaming-video-for-free/> [Publication date: Jun. 8, 2009].

Author: Matt Burns—Publication Source: TechCrunch—Title: TV Everywhere is Comcast and Time Warner's answer to free internet video—Internet Publication: <http://techcrunch.com/2009/06/24/teverywhere-is-comcast-and-time-warner-s-answer-to-free-internet-video/> [Publication date: Jun. 24, 2009].

Author: Michael Arrington—Movie Labels to Launch New "Open Market" Play Anywhere Scheme As Last Ditch Effort to Save DRM—Publication Source: TechCrunch.com [URL: <http://techcrunch.com/2008/08/26/movie-labels-to-launch-new-open-market-play-anywhere-scheme-as-last-ditch-effort-to-save-drm/>]—(Internet Publication Aug. 26, 2008).

Author: Mitch Singer—Developing the Digital Market—Publication Source: TechCrunch.com [URL: <http://techcrunch.files.wordpress.com/2008/08/singer.pdf>]—(Internet Publication Aug. 26, 2008).

## US 8,402,555 B2

Page 3

- Author: Brian Fox—Title: DECE UltraViolet Response to STROEM Licensing Offer—Internet Publication: <http://www.doestoc.com/docs/100643534/DECE-Note/> [Publication date: Oct. 25, 2011]. Abandoned USPTO U.S. Appl. No. 61/303,292 (evidence to overcome examiner's last rejection in accordance with MPEP 2142).
- Author—Preston Gralla—Digital River Launches DRM Solution for Software Publishers—Publication Source: [informationweek.com](http://www.informationweek.com) [URL: <http://www.informationweek.com/news/18961739/>]—(Internet Publication Date: Apr. 15, 2004).
- Author—Digital River Corporation—Digital River Announces New Digital Rights Management Service—Publication Source: [digitalriver.com](http://www.digitalriver.com) [URL: [http://www.digitalriver.com/corporate/press\\_releases/pr\\_328.shtml](http://www.digitalriver.com/corporate/press_releases/pr_328.shtml)]—(Internet Publication Date: Jul. 14, 2003).
- Author—Digital River Corporation—Digital River SoftwarePassport Copyright software—Publication Source: [siliconrealms.com](http://www.siliconrealms.com) [URL: <http://www.siliconrealms.com/>]—(Internet Publication), Aug. 26, 2010.
- Internet publication: Nook Color LendMe [www.barnesandnoble.com/](http://www.barnesandnoble.com/), Jan. 21, 2011.
- Internet publication: Coral consortium "Scenario" [www.coral-interop.org](http://www.coral-interop.org), Feb. 27, 2006.
- Author—Wikipedia Org.—Steam (software)—Publication Source: [wikipedia.org](http://en.wikipedia.org/wiki/Steam_(software)) [URL: [http://en.wikipedia.org/wiki/Steam\\_\(software\)](http://en.wikipedia.org/wiki/Steam_(software))], Aug. 13, 2004.
- Author—William Grecia—STR3EM Windows Java C++ written code copyright and support documentation—Publication Source: [str3em.com](http://www.str3em.com) [URL: <http://www.str3em.com/>]—(Software Copyright Publication Date and Invention Reduced to Practice: Sep. 3, 2009).
- Author—William Grecia—Next Generation Digital Delivery STR3EM Ecosystem Replaces DVD and Blu-Ray—Publication Source: [mi2a.com](http://mi2a.com) [URL: [http://mi2a.com/press.php?press\\_nb=130517](http://mi2a.com/press.php?press_nb=130517)]—(Internet Publication Date: May 28, 2010).
- Author—Facebook Corporation—Graph API documentation—Publication Source: [facebook.com](http://facebook.com) [URL: <http://developers.facebook.com/docs/api/>]—(Internet Publication Update: Apr. 21, 2010).
- Author—Amazon Inc.—Amazon Web Services API documentation—Publication Source: [URL: <http://aws.amazon.com/>]—(Internet Publication), Jul. 16, 2002.
- Author—Rick Merritt—Analysis: Hollywood's next digital media gambit—Publication Source: [oetimes.com](http://www.oetimes.com) [URL: <http://www.oetimes.com/design/audio-design/4005862/Analysis-Hollywood-s-next-digital-media-gambit/>]—(Internet Publication Date: Nov. 2, 2008).
- Author—Ethan Smith—Disney Touts a Way to Ditch the DVD—Publication Source: [Wall Street Journal Online](http://www.wsj.com) [URL: [http://online.wsj.com/article/NA\\_WSJ...PU:B:SB10001424052748703816204575585650026945222.html](http://online.wsj.com/article/NA_WSJ...)]—(Internet Publication Date: Sep. 21, 2009).
- Author—Nada Ulaby—Introducing UltraViolet. Buy Your Digital Movie Once, Play It Anywhere?—Publication Source: [NPR Online](http://www.npr.org) [URL: <http://www.npr.org/blogs/monkeysee/2010/07/19/128626624/introducing-ultraviolet-buy-your-movie-once-play-it-anywhere/>]—(Internet Publication Date: Jul. 20, 2010).
- Author—William Grecia—The Retail Zip Company Releases Secure Electronic Media Format STR3EM to Replace DVD and Blu-ray—Publication Source: [mi2a.com](http://mi2a.com) [URL: [http://mi2a.com/press.php?press\\_nb=1122843](http://mi2a.com/press.php?press_nb=1122843)]—(Internet Publication Date: Sep. 3, 2009).
- Author—Apple Corporation—(iTunes application copyright—Publication Source: [apple.com](http://apple.com) [URL: [www.apple.com/itunes/](http://www.apple.com/itunes/)]—(Copyright Publication Date: Jan. 9, 2011).
- Author—Microsoft Corporation—Zune application copyright—Publication Source: [zune.net](http://zune.net) [URL: [www.zune.net/](http://www.zune.net/)]—(Copyright Publication Date: Nov. 14, 2006).
- Author—Netflix Corporation—Netflix application copyright—Publication Source: [netflix.com](http://netflix.com) [URL: [www.netflix.com/](http://www.netflix.com/)]—(Copyright Publication), Jan. 15, 2007.
- Author—Best Buy Corporation—CinemaNow application copyright—Publication Source: [cinemanow.com](http://cinemanow.com) [URL: [www.cinemanow.com/](http://www.cinemanow.com/)]—(Copyright Publication), May 18, 2010.
- Author—Best Buy Corporation—Napster application copyright—Publication Source: [napster.com](http://napster.com) [URL: [www.napster.com/](http://www.napster.com/)]—(Copyright Publication), May 1, 2006.
- Author—Google Corporation—YouTube application copyright—Publication Source: [youtube.com](http://youtube.com) [URL: [www.youtube.com/](http://www.youtube.com/)]—(Copyright Publication), Feb. 14, 2005.
- Author—Wal-Mart Corporation—Vudu application copyright—Publication Source: [vudu.com](http://vudu.com) [URL: [www.vudu.com/](http://www.vudu.com/)]—(Copyright Publication), Sep. 6, 2007.
- Author—Connected Media Experience Org.—CMX specification—Publication Source: [connectedmediaexperience.org](http://connectedmediaexperience.org) [URL: [www.connectedmediaexperience.org/technicaloversiew.html](http://www.connectedmediaexperience.org/technicaloversiew.html)]—(Internet Publication), Jan. 27, 2009.
- Author—SMPTE Org.—Digital Cinema DCP MXF specifications—Publication Source: [smpte.org](http://www.smpte.org) [URL: [www.smpte.org/standards/](http://www.smpte.org/standards/)]—(Internet Publication), Oct. 8, 2002.
- Author—Wikipedia Org.—Xbox Live Marketplace and Zune Marketplace—Publication Source: [wikipedia.org](http://en.wikipedia.org/wiki/Xbox_Live_Marketplace_and_Zune_Marketplace) [URL: [http://en.wikipedia.org/wiki/Xbox\\_Live\\_Marketplace\\_and\\_Zune\\_Marketplace](http://en.wikipedia.org/wiki/Xbox_Live_Marketplace_and_Zune_Marketplace)]—(Internet Publication), Jan. 18, 2006.
- Author—Dan Franks—First Look: iTunes Digital Copy—Publication Source: [macworld.com](http://macworld.com) [URL: [www.macworld.com/article/131751/2008/01/digitalcopy.html](http://www.macworld.com/article/131751/2008/01/digitalcopy.html)]—(Internet Publication Jan. 22, 2008).
- Author—Rich Fiscus—Review—Is DVD Digital Copy worth the trouble?—Publication Source: [aherdawn.com](http://www.aherdawn.com) [URL: [www.aherdawn.com/news/article.cfm?2009/11/18/review\\_is\\_dvd\\_digital\\_copy\\_worth\\_the\\_trouble/](http://www.aherdawn.com/news/article.cfm?2009/11/18/review_is_dvd_digital_copy_worth_the_trouble/)]—(Internet Publication Nov. 18, 2009).
- Author—Wikipedia Org.—Digital rights management—Publication Source: [wikipedia.org](http://en.wikipedia.org/wiki/Digital_Rights_Management) [URL: [http://en.wikipedia.org/wiki/Digital\\_Rights\\_Management](http://en.wikipedia.org/wiki/Digital_Rights_Management)]—(Internet Publication), Sep. 22, 2002.
- Author—Wikipedia Org.—Application programming interface—Publication Source: [wikipedia.org](http://en.wikipedia.org/wiki/API) [URL: <http://en.wikipedia.org/wiki/API>]—(Internet Publication), Jul. 30, 2001.
- Author—Wikipedia Org.—Steam (content delivery)—Publication Source: [wikipedia.org](http://en.wikipedia.org/wiki/Steam_(content_delivery)) [URL: [http://en.wikipedia.org/wiki/Steam\\_\(content\\_delivery\)](http://en.wikipedia.org/wiki/Steam_(content_delivery))]—(Internet Publication), Sep. 13, 2004.
- Author—Ben Drushlough—Disney's KeyChest is not DRM—Publication Source: [engadget.com](http://engadget.com) [URL: [www.engadget.com/2010/01/16/disneys-keychest-is-not-drm/](http://www.engadget.com/2010/01/16/disneys-keychest-is-not-drm/)]—(Internet Publication Jan. 16, 2010).
- Author—Richard Lawler—DECE & KeyChest both laying claim to friendly DRM of the future title—Publication Source: [engadget.com](http://engadget.com) [URL: [www.engadget.com/2010/01/06/dece-and-keychain-both-laying-claim-to-friendly-drm-of-the-future/](http://www.engadget.com/2010/01/06/dece-and-keychain-both-laying-claim-to-friendly-drm-of-the-future/)]—(Internet Publication Jan. 6, 2010).

\* cited by examiner

**UNITED STATES DISTRICT COURT  
FOR THE Northern District of Illinois – CM/ECF LIVE, Ver 6.1.1  
Eastern Division**

William Grecia

Plaintiff,

v.

Case No.: 1:16-cv-10211  
Honorable Joan H. Lefkow

Big Ten Network Services, LLC

Defendant.

---

**NOTIFICATION OF DOCKET ENTRY**

This docket entry was made by the Clerk on Wednesday, March 8, 2017:

MINUTE entry before the Honorable Joan H. Lefkow: Status hearing of 3/14/2017 stricken. Pursuant to Stipulation of Dismissal With Prejudice [27], case dismissed with prejudice, with each party to bear its own costs, expenses, and attorneys' fees. Civil case terminated. Mailed notice(mad, )

**ATTENTION:** This notice is being sent pursuant to Rule 77(d) of the Federal Rules of Civil Procedure or Rule 49(c) of the Federal Rules of Criminal Procedure. It was generated by CM/ECF, the automated docketing system used to maintain the civil and criminal dockets of this District. If a minute order or other document is enclosed, please refer to it for additional information.

For scheduled events, motion practices, recent opinions and other information, visit our web site at [www.ilnd.uscourts.gov](http://www.ilnd.uscourts.gov).

A TRUE COPY ATTEST  
THOMAS G. BRUTON, CLERK  
By: BROOK GUDAUSKY  
DEPUTY CLERK  
U.S. DISTRICT COURT, NORTHERN  
DISTRICT OF ILLINOIS  
March 9, 2017

EWS-003438



AO 120 (Rev. 08/10)

TO: <b>Mail Stop 8</b> <b>Director of the U.S. Patent and Trademark Office</b> <b>P.O. Box 1450</b> <b>Alexandria, VA 22313-1450</b>	<b>REPORT ON THE</b> <b>FILING OR DETERMINATION OF AN</b> <b>ACTION REGARDING A PATENT OR</b> <b>TRADEMARK</b>
---	---

In Compliance with 35 U.S.C. § 290 and/or 15 U.S.C. § 1116 you are hereby advised that a court action has been filed in the U.S. District Court Northern District of Illinois on the following

Trademarks or  Patents. (  the patent action involves 35 U.S.C. § 292.);

DOCKET NO. 16cv10221	DATE FILED 10/31/2016	U.S. DISTRICT COURT Northern District of Illinois
PLAINTIFF William Grecia		DEFENDANT NFL Network Services, LLC
PATENT OR TRADEMARK NO.	DATE OF PATENT OR TRADEMARK	HOLDER OF PATENT OR TRADEMARK
1 SEE ATTACHMENT		
2 8533860		
3 8402555		
4		
5		

In the above—entitled case, the following patent(s)/ trademark(s) have been included:

DATE INCLUDED	INCLUDED BY <input type="checkbox"/> Amendment <input type="checkbox"/> Answer <input type="checkbox"/> Cross Bill <input type="checkbox"/> Other Pleading		
PATENT OR TRADEMARK NO.	DATE OF PATENT OR TRADEMARK	HOLDER OF PATENT OR TRADEMARK	
1			
2			
3			
4			
5			

In the above—entitled case, the following decision has been rendered or judgement issued:

DECISION/JUDGEMENT
--------------------

CLERK Thomas G. Bruton	(BY) DEPUTY CLERK Chez Chambers	DATE 3/8/2017
---------------------------	------------------------------------	------------------

Copy 1—Upon initiation of action, mail this copy to Director Copy 3—Upon termination of action, mail this copy to Director  
 Copy 2—Upon filing document adding patent(s), mail this copy to Director Copy 4—Case file copy

<b>TO:</b> <b>Mail Stop 8</b> <b>Director of the U.S. Patent and Trademark Office</b> <b>P.O. Box 1450</b> <b>Alexandria, VA 22313-1450</b>	<b>REPORT ON THE</b> <b>FILING OR DETERMINATION OF AN</b> <b>ACTION REGARDING A PATENT OR</b> <b>TRADEMARK</b>
---	---

In Compliance with 35 U.S.C. § 290 and/or 15 U.S.C. § 1116 you are hereby advised that a court action has been filed in the U.S. District Court Northern District of Illinois on the following

Trademarks or  Patents. (  the patent action involves 35 U.S.C. § 292.):

DOCKET NO. 16-cv-10213	DATE FILED 10/31/2016	U.S. DISTRICT COURT Northern District of Illinois
PLAINTIFF William Grecia		DEFENDANT Cablevision Systems Corporation
PATENT OR TRADEMARK NO.	DATE OF PATENT OR TRADEMARK	HOLDER OF PATENT OR TRADEMARK
1 US 8,533,860 B1	9/10/2013	William Grecia
2 US 8,402,555 B2	3/19/2013	William Grecia
3		
4		
5		

In the above—entitled case, the following patent(s)/ trademark(s) have been included:

DATE INCLUDED	INCLUDED BY <input type="checkbox"/> Amendment <input type="checkbox"/> Answer <input type="checkbox"/> Cross Bill <input type="checkbox"/> Other Pleading		
PATENT OR TRADEMARK NO.	DATE OF PATENT OR TRADEMARK	HOLDER OF PATENT OR TRADEMARK	
1			
2			
3			
4			
5			

In the above—entitled case, the following decision has been rendered or judgement issued:

DECISION/JUDGEMENT

CLERK Thomas G. Bruton	(BY) DEPUTY CLERK Michelle Copeland	DATE 11/1/2016
---------------------------	--	-------------------

Copy 1—Upon initiation of action, mail this copy to Director Copy 3—Upon termination of action, mail this copy to Director  
 Copy 2—Upon filing document adding patent(s), mail this copy to Director Copy 4—Case file copy

EWS-003440

Inventor submits a record of current day practicing products in presentation to entities after December 2016. Claim steps of this patent for which products must perform to operate are:

*Independent Claim Steps:*

- 1) Receive a verification token from a user
- 2) Authenticate the verification token
- 3) Establish a connection with the API web service of Apple or Google
- 4) Request an identification reference (Device Token for push notifications)
- 5) Receive the identification reference (Device Token for push notifications)
- 6) Write at least one of the verification token or the identification reference into a data store (e.g., metadata) associated with the computer based apparatus.

T-Mobile Wi-Fi 6:15 PM 41%

# RICOH

**Device Number:**

**3025553000**

**Device Pin:**

**3309**



RESET DEVICE PIN



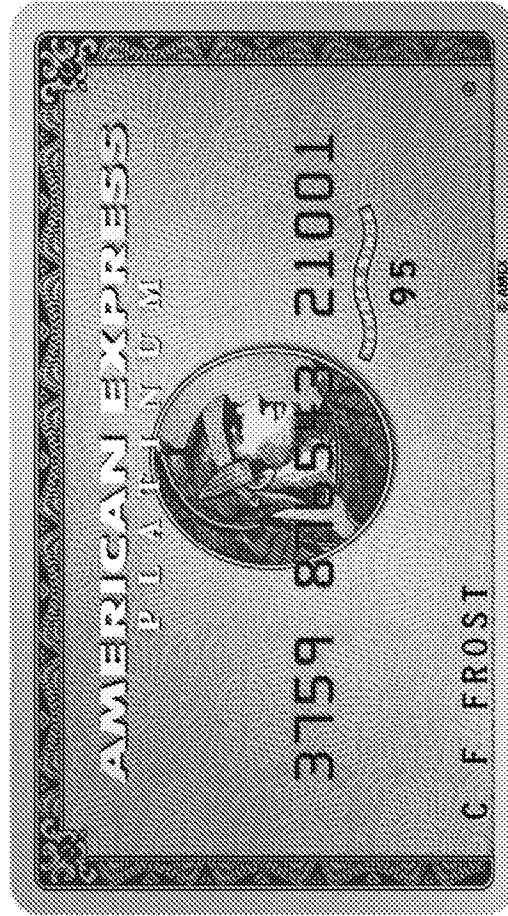
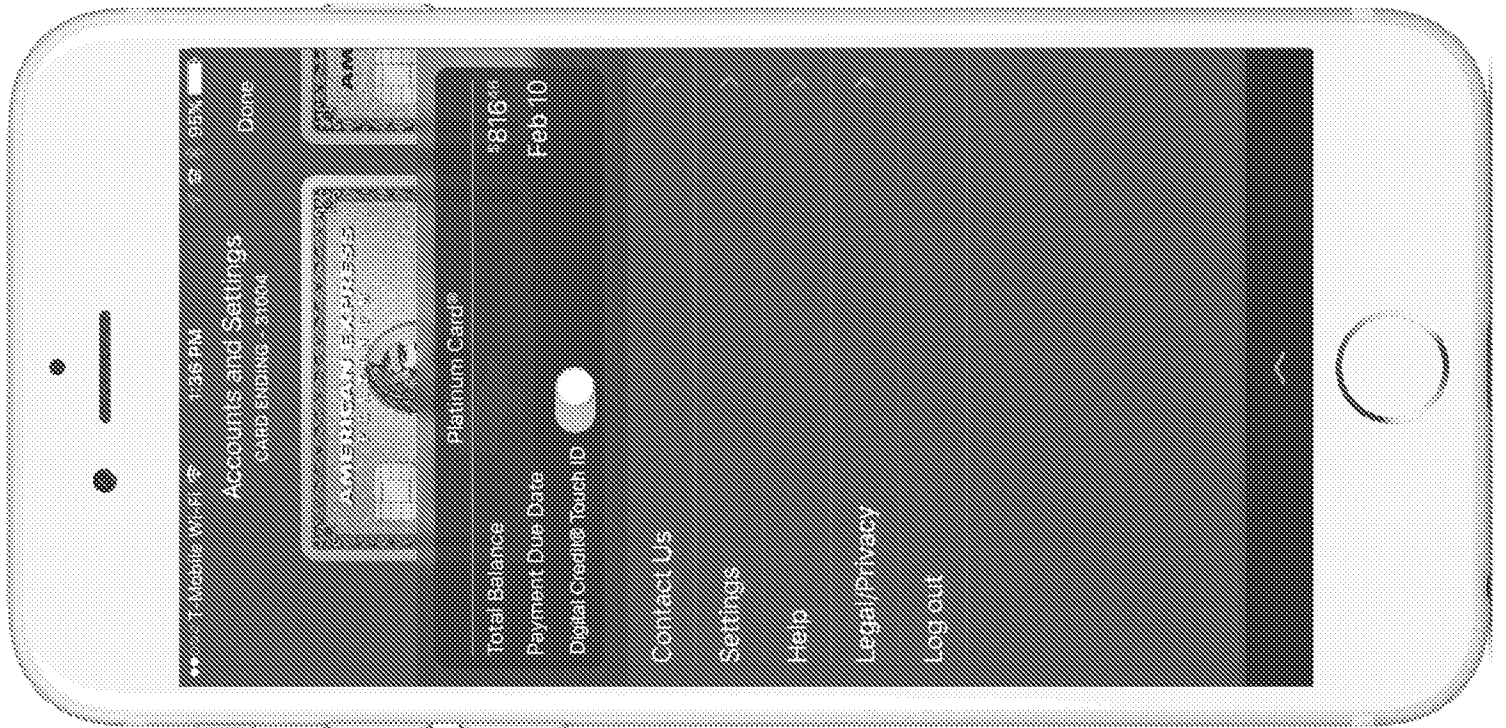

## Electronic Acknowledgement Receipt

<b>EFS ID:</b>	28318874
<b>Application Number:</b>	13740086
<b>International Application Number:</b>	
<b>Confirmation Number:</b>	7081
<b>Title of Invention:</b>	PERSONALIZED DIGITAL MEDIA ACCESS SYSTEM - PDMAS PART II
<b>First Named Inventor/Applicant Name:</b>	William Grecia
<b>Customer Number:</b>	70984
<b>Filer:</b>	William Grecia
<b>Filer Authorized By:</b>	
<b>Attorney Docket Number:</b>	
<b>Receipt Date:</b>	10-FEB-2017
<b>Filing Date:</b>	11-JAN-2013
<b>Time Stamp:</b>	06:58:53
<b>Application Type:</b>	Utility under 35 USC 111(a)

### Payment information:

Submitted with Payment	no
------------------------	----

### File Listing:

Document Number	Document Description	File Name	File Size(Bytes)/ Message Digest	Multi Part /.zip	Pages (if appl.)
1	Miscellaneous Incoming Letter	Inventor_practice_disclosure. pdf	5549329 <small>7abc70245aac0658c9d0cb935211685525f 44c26</small>	no	4

### Warnings:

EWS-003445

<b>Information:</b>	
<b>Total Files Size (in bytes):</b>	5549329
<p><b>This Acknowledgement Receipt evidences receipt on the noted date by the USPTO of the indicated documents, characterized by the applicant, and including page counts, where applicable. It serves as evidence of receipt similar to a Post Card, as described in MPEP 503.</b></p> <p><b><u>New Applications Under 35 U.S.C. 111</u></b> If a new application is being filed and the application includes the necessary components for a filing date (see 37 CFR 1.53(b)-(d) and MPEP 506), a Filing Receipt (37 CFR 1.54) will be issued in due course and the date shown on this Acknowledgement Receipt will establish the filing date of the application.</p> <p><b><u>National Stage of an International Application under 35 U.S.C. 371</u></b> If a timely submission to enter the national stage of an international application is compliant with the conditions of 35 U.S.C. 371 and other applicable requirements a Form PCT/DO/EO/903 indicating acceptance of the application as a national stage submission under 35 U.S.C. 371 will be issued in addition to the Filing Receipt, in due course.</p> <p><b><u>New International Application Filed with the USPTO as a Receiving Office</u></b> If a new international application is being filed and the international application includes the necessary components for an international filing date (see PCT Article 11 and MPEP 1810), a Notification of the International Application Number and of the International Filing Date (Form PCT/RO/105) will be issued in due course, subject to prescriptions concerning national security, and the date shown on this Acknowledgement Receipt will establish the international filing date of the application.</p>	



AO 120 (Rev. 3/04)

TO: <b>Mail Stop 8</b> <b>Director of the U.S. Patent and Trademark Office</b> <b>P.O. Box 1450</b> <b>Alexandria, VA 22313-1450</b>	<b>REPORT ON THE</b> <b>FILING OR DETERMINATION OF AN</b> <b>ACTION REGARDING A PATENT OR</b> <b>TRADEMARK</b>
---	---

In Compliance with 35 U.S.C. § 290 and/or 15 U.S.C. § 1116 you are hereby advised that a court action has been filed in the U.S. District Court Delaware on the following  Patents or  Trademarks:

DOCKET NO. 15cv532-RGA	DATE FILED 3/27/2015	U.S. DISTRICT COURT DISTRICT OF DELAWARE
PLAINTIFF William Grecia		DEFENDANT RCN Telecom Services LLC
PATENT OR TRADEMARK NO.	DATE OF PATENT OR TRADEMARK	HOLDER OF PATENT OR TRADEMARK
1 8,533,860	9/10/2013	William Grecia
2		
3		
4		
5		

In the above—entitled case, the following patent(s)/ trademark(s) have been included:

DATE INCLUDED	INCLUDED BY <input type="checkbox"/> Amendment <input type="checkbox"/> Answer <input type="checkbox"/> Cross Bill <input type="checkbox"/> Other Pleading		
PATENT OR TRADEMARK NO.	DATE OF PATENT OR TRADEMARK	HOLDER OF PATENT OR TRADEMARK	
1			
2			
3			
4			
5			

In the above—entitled case, the following decision has been rendered or judgement issued:

DECISION/JUDGEMENT  See attached Order
--

CLERK JOHN A. CERINO, CLERK OF COURT	(BY) DEPUTY CLERK	DATE 12/14/2015
---	-------------------	--------------------

Copy 1—Upon initiation of action, mail this copy to Director    Copy 3—Upon termination of action, mail this copy to Director  
 Copy 2—Upon filing document adding patent(s), mail this copy to Director    Copy 4—Case file copy

Submission of Inventor and current Patent Owner as of 1/18/17 practice of this patent and a file wrapper record of a duly marked product in accordance with 35 U.S.C. § 287(a).

Respectfully submitted

/william grecia/

William Grecia

Inventor and Patent Owner



[KodeKey IAM Service Device Registration](#)      [TOS](#)

## About Us

For business inquiries and customer service:

Phone: 844-KodeKey (844-563-3539)

e-mail: [business@kodekey.com](mailto:business@kodekey.com)

KodeKey is owned and operated by [Qordado LLC](#).

[What is KodeKey?](#)

[Key People](#)

### When you need to **prove that you're you™**, use KodeKey!

KodeKey is an authorization system for websites (and other services) to use the fingerprint reader on Samsung Galaxy and Apple devices as a login credential.

Offering fingerprint authentication as a service, we work with business and enterprise clients to build-in our patented authorization technology with existing and new platforms.

KodeKey is the world's first public user verification system with a focus on better operations security by introducing a mechanism that combine user authentication with mobile numbers. KodeKey can be implemented in existing systems using our easy API for a passwordless experience or as a second factor experience.

With a diverse range of possibilities, examples of KodeKey utilization includes:

# As a username & password replacement

(Using the mobile number users know and an easy-to-remember 4 digit pin)

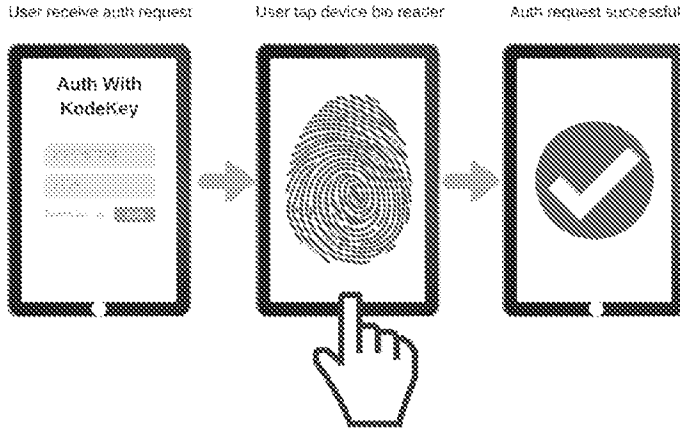

# Or a customer service verification

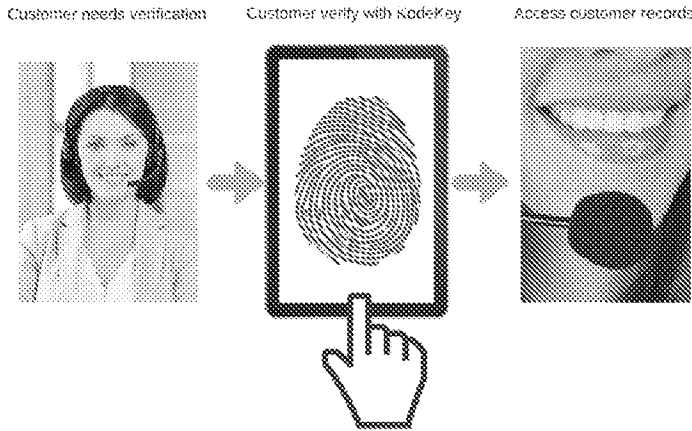

# And unlimited possibilites...

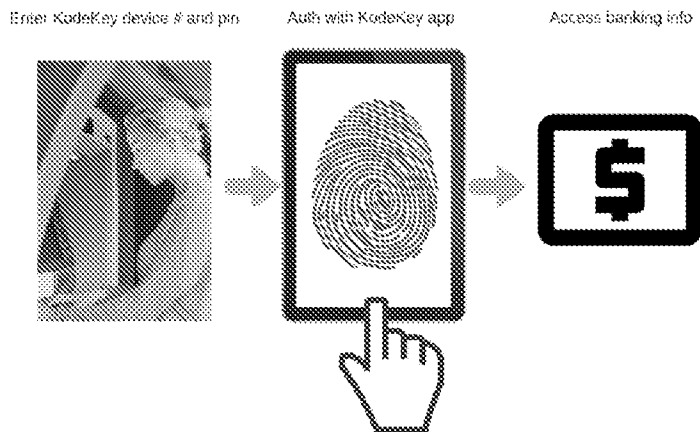

*The following products are protected by patents licensed in the U.S.*

*This section is provided to satisfy the virtual patent marking provisions of the America Invents Act.*

*KodeKey: Protected by U.S. Patents 8,402,555, 8,533,860, and 8,887,308*

# KodeKey™

KodeKey IAM Service Device Registration      TOS

## About Us

For business inquiries and customer service:

Phone: 844-KodeKey (844-563-3539)

e-mail: [business@kodekey.com](mailto:business@kodekey.com)

KodeKey is owned and operated by [Qordado LLC](#).

[What is KodeKey?](#)

[Key People](#)

William Grecia | Co-Founder, Executive Chairman

 [View William Grecia's profile](#)

*Mr. Grecia is the inventor of the KodeKey and TypeLocker systems.*

*in 2010, Mr. Grecia authored and won 3 issued patents related to Cloud Authorization and Network Tokenization.*

Edward Robles | Co-Founder, Chief Executive Officer

 [View Edward Robles profile](#)

*Mr. Robles is a founding Partner of Smart Data Technology Consultants, a company acquired by Xerox Corp in 2014.*

*Mr. Robles is a recognized expert in electronic discovery and discovery management issues. He has advised on implementation and planning issues associated with all phases of electronic discovery in litigations and investigations as well as electronically stored information (ESI) management policies and practices.*

Search for:



## Electronic Acknowledgement Receipt

<b>EFS ID:</b>	28101228
<b>Application Number:</b>	13740086
<b>International Application Number:</b>	
<b>Confirmation Number:</b>	7081
<b>Title of Invention:</b>	PERSONALIZED DIGITAL MEDIA ACCESS SYSTEM - PDMAS PART II
<b>First Named Inventor/Applicant Name:</b>	William Grecia
<b>Customer Number:</b>	70984
<b>Filer:</b>	William Grecia
<b>Filer Authorized By:</b>	
<b>Attorney Docket Number:</b>	
<b>Receipt Date:</b>	18-JAN-2017
<b>Filing Date:</b>	11-JAN-2013
<b>Time Stamp:</b>	20:20:00
<b>Application Type:</b>	Utility under 35 USC 111(a)

### Payment information:

Submitted with Payment	no
------------------------	----

### File Listing:

Document Number	Document Description	File Name	File Size(Bytes)/ Message Digest	Multi Part /.zip	Pages (if appl.)
1	Miscellaneous Incoming Letter	Practicing_Status_pto.pdf	1247103  <small>31f2cb00d9d1c55b9ad5bb0bba19ebe447c33c5</small>	no	4

### Warnings:

EWS-003452

<b>Information:</b>	
<b>Total Files Size (in bytes):</b>	1247103
<p><b>This Acknowledgement Receipt evidences receipt on the noted date by the USPTO of the indicated documents, characterized by the applicant, and including page counts, where applicable. It serves as evidence of receipt similar to a Post Card, as described in MPEP 503.</b></p> <p><b><u>New Applications Under 35 U.S.C. 111</u></b> If a new application is being filed and the application includes the necessary components for a filing date (see 37 CFR 1.53(b)-(d) and MPEP 506), a Filing Receipt (37 CFR 1.54) will be issued in due course and the date shown on this Acknowledgement Receipt will establish the filing date of the application.</p> <p><b><u>National Stage of an International Application under 35 U.S.C. 371</u></b> If a timely submission to enter the national stage of an international application is compliant with the conditions of 35 U.S.C. 371 and other applicable requirements a Form PCT/DO/EO/903 indicating acceptance of the application as a national stage submission under 35 U.S.C. 371 will be issued in addition to the Filing Receipt, in due course.</p> <p><b><u>New International Application Filed with the USPTO as a Receiving Office</u></b> If a new international application is being filed and the international application includes the necessary components for an international filing date (see PCT Article 11 and MPEP 1810), a Notification of the International Application Number and of the International Filing Date (Form PCT/RO/105) will be issued in due course, subject to prescriptions concerning national security, and the date shown on this Acknowledgement Receipt will establish the international filing date of the application.</p>	

Junior patents citing this patent as prior art for inclusion within this file wrapper for educational reference:

U.S. Patents 9,342,832 and 9,519,802





(12) **United States Patent**  
**Dutta**

(10) **Patent No.:** **US 9,519,802 B2**  
(45) **Date of Patent:** **Dec. 13, 2016**

(54) **SYSTEMS AND METHODS FOR DOCUMENT AND DATA PROTECTION**

(71) Applicant: **AMERICAN EXPRESS TRAVEL RELATED SERVICES COMPANY, INC.**, New York, NY (US)

(72) Inventor: **Siddhartha Dutta**, Peoria, AZ (US)

(73) Assignee: **AMERICAN EXPRESS TRAVEL RELATED SERVICES COMPANY, INC.**, New York, NY (US)

8,402,555	B2	3/2013	Grecia	
8,458,487	B1*	6/2013	Palgon et al.	713/185
8,533,860	B1	9/2013	Grecia	
8,887,308	B2	11/2014	Grecia	
2007/0113171	A1*	5/2007	Behrens et al.	715/513
2011/0154467	A1	6/2011	Bomar et al.	
2011/0213807	A1	9/2011	Mattsson	
2011/0307710	A1	12/2011	McGuire et al.	
2012/0173431	A1	7/2012	Ritchie et al.	
2012/0278339	A1	11/2012	Wang	
2012/0278897	A1*	11/2012	Ang	H04L 61/2596 726/26
2013/0246422	A1*	9/2013	Bhargava et al.	707/737

(\* ) Notice: Subject to any disclaimer, the term of this patent is extended or adjusted under 35 U.S.C. 154(b) by 13 days.

(21) Appl. No.: **14/272,262**

(22) Filed: **May 7, 2014**

(65) **Prior Publication Data**

US 2015/0324592 A1 Nov. 12, 2015

(51) **Int. Cl.**

**G06F 21/00** (2013.01)  
**G06F 21/62** (2013.01)  
**G06F 21/60** (2013.01)

(52) **U.S. Cl.**

CPC ..... **G06F 21/6245** (2013.01); **G06F 21/602** (2013.01); **G06F 2221/2107** (2013.01)

(58) **Field of Classification Search**

CPC .... **G06F 21/60**; **G06F 21/602**; **G06F 21/6245**; **G06F 221/2107**

See application file for complete search history.

(56) **References Cited**

**U.S. PATENT DOCUMENTS**

7,239,226 B2 7/2007 Berardi et al.  
7,627,531 B2 12/2009 Breck et al.

**OTHER PUBLICATIONS**

International Preliminary Report on Patentability dated Oct. 26, 2015 in Application No. PCT/US2015/024877.  
Sommers, "Tokenization in Depth—A Detailed Look at Tokenization and its Advantages over Encryption," Shift4 Secure Payment Processing, 2010, Shift4 Corporation, 1-12.  
International Search Report and Written Opinion dated Jul. 20, 2015 in Application No. PCT/US2015/024877.

\* cited by examiner

*Primary Examiner* — Kendall Dolly

(74) *Attorney, Agent, or Firm* — Snell & Wilmer L.L.P.

(57) **ABSTRACT**

The present disclosure includes a method comprising encrypting sensitive data, generating a token comprising a data identifier, tokenizing the encrypted sensitive data, and/or storing the encrypted sensitive data in association with the token to a token vault. Tokenizing may comprise mapping the encrypted sensitive data to the token. The method may further comprise storing the token to a cloud application, wherein the cloud application comprises a software application that functions within a cloud computing environment.

**14 Claims, 4 Drawing Sheets**

100B

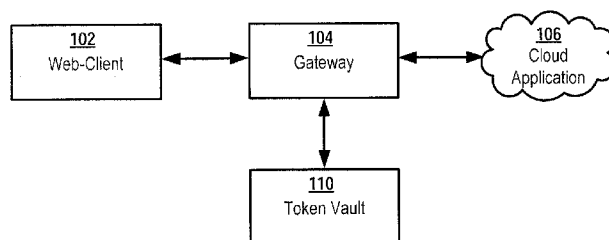

100A

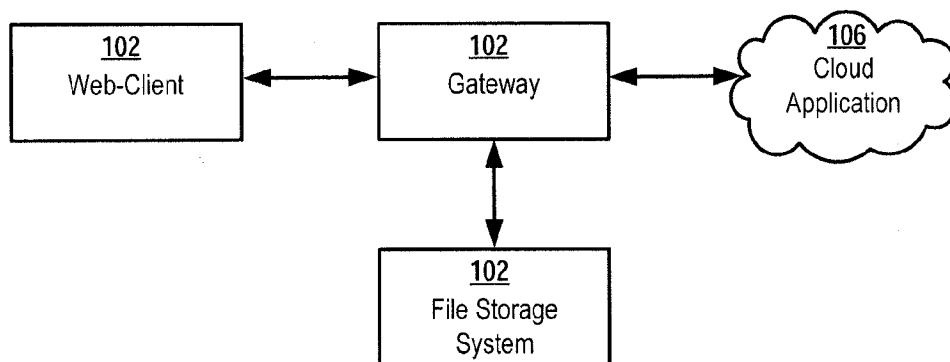

FIG. 1A

100B

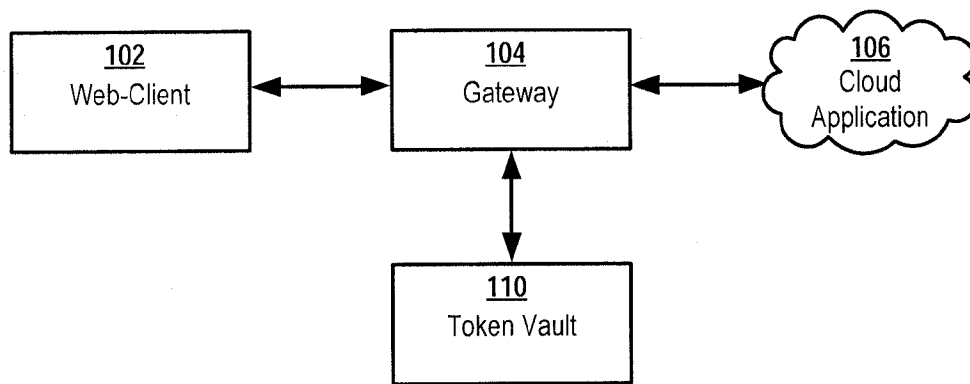

FIG. 1B

200A

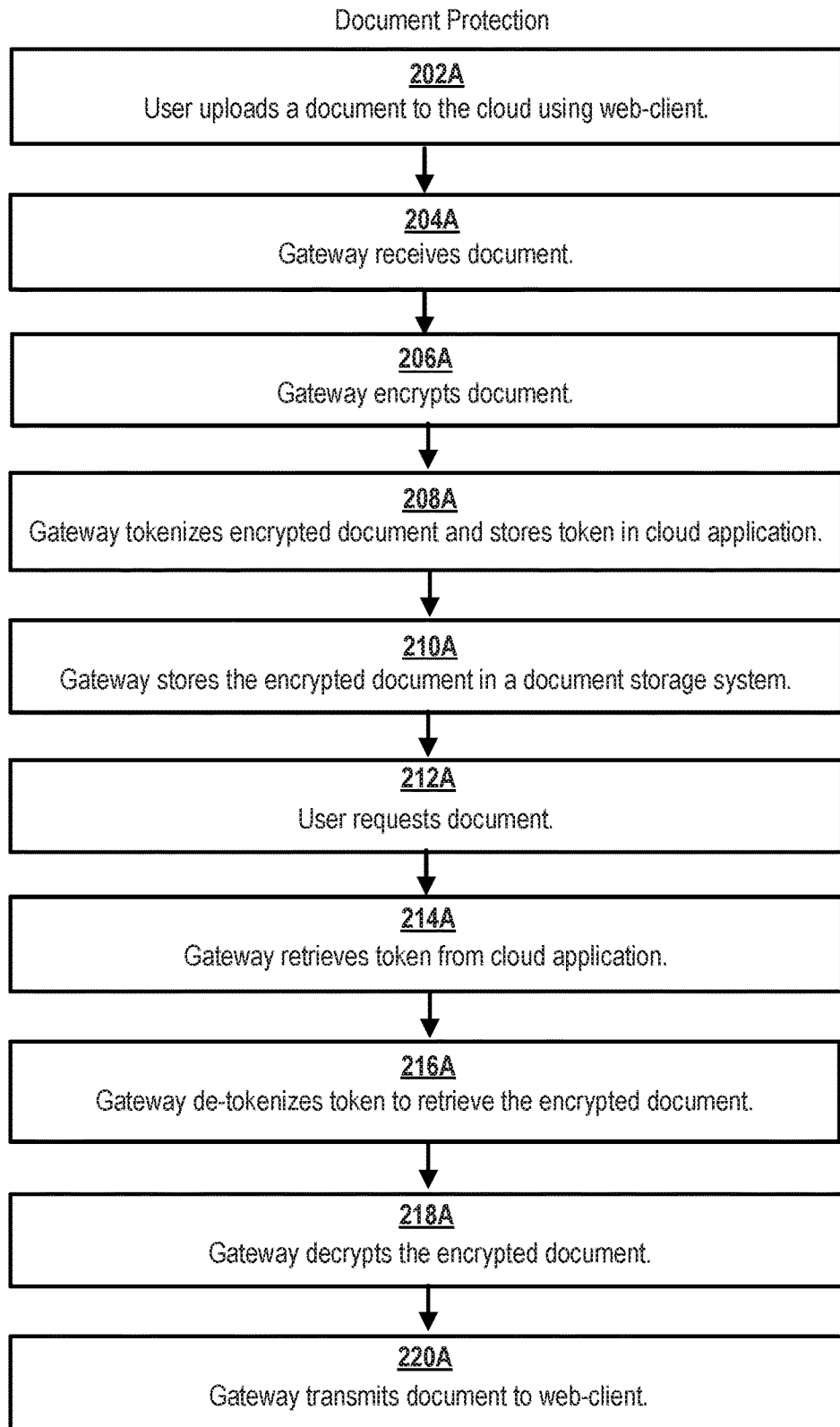

FIG. 2A

200B

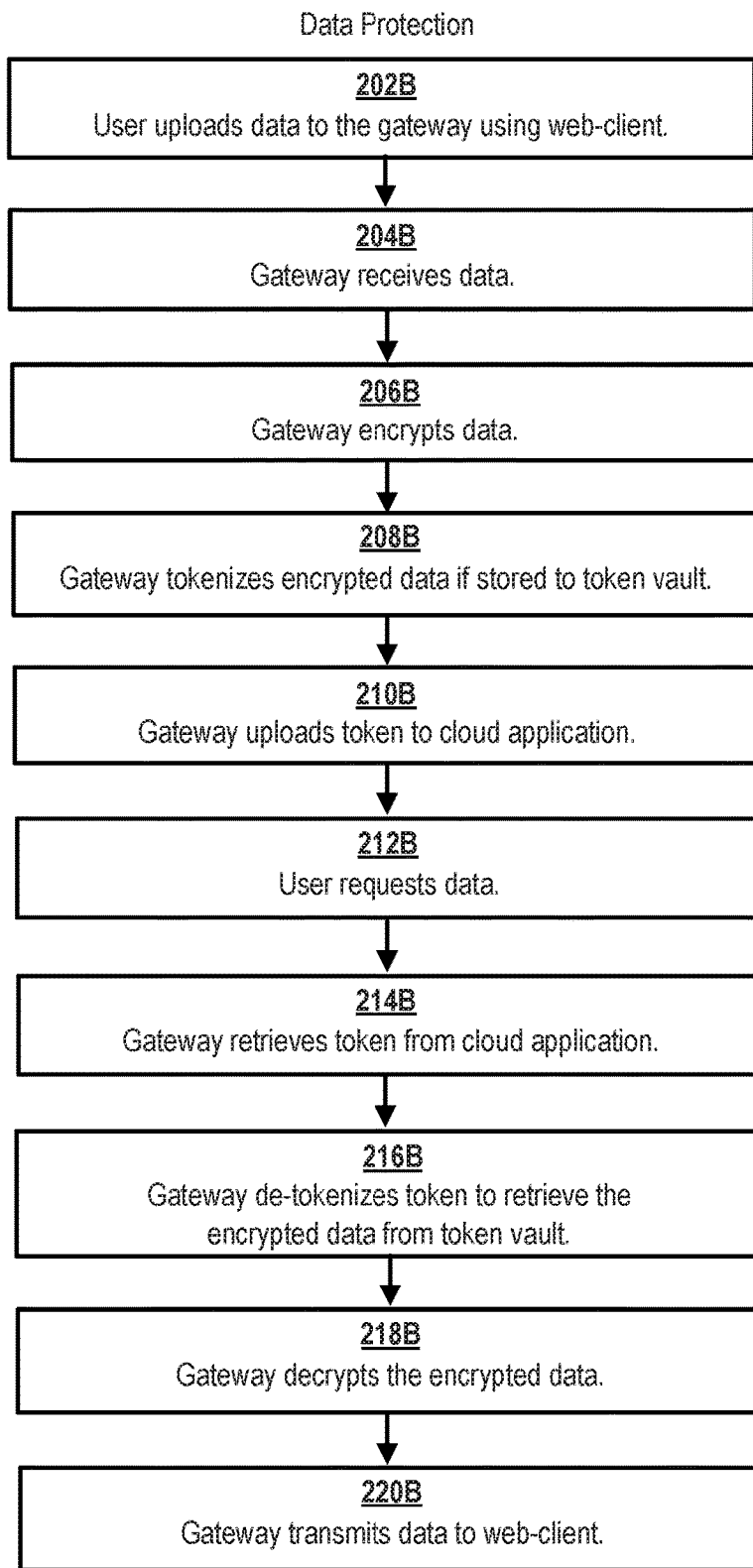

FIG. 2B

1

## SYSTEMS AND METHODS FOR DOCUMENT AND DATA PROTECTION

### FIELD

The present disclosure generally relates to document and data protection, and more particularly, to systems and methods for the protection of sensitive documents and/or data in conjunction with a cloud computing application, or external hosting services.

### BACKGROUND

At present, enterprise documents and data are protected in several ways, each having their respective disadvantages. Briefly, documents and/or data may be encrypted and uploaded to a cloud computing application. Obviously, this method leaves sensitive data and/or documents exposed to unwanted decryption if encryption keys are breached. In addition, encryption may break application/user functions such as Search, Sort, etc. In addition, many cloud providers will not accept documents exceeding a certain file size (e.g., five megabytes). Moreover, company policies may prohibit the exportation of sensitive data to a cloud application, while some markets (e.g., China, Germany, and Switzerland) may have very strict data exportation laws, such that documents and/or data stored in a Europe-based cloud may not be exported, for example, to a United States based location.

To mitigate some of these problems, various enterprises have stored unencrypted documents and/or data to a local data storage system (e.g., a token vault or file system) through the use of a tokenization system. To gain access to this data, and to leverage cloud applications for data and document distribution within the enterprise, the data and/or documents have been tokenized (i.e., associate the documents or data with a random alphanumeric string or file path) and the token stored to the cloud application. Disadvantages exist here as well. For example, a hacker or disgruntled employee may hack into the token vault or file system, and gain access to the unencrypted documents and/or data stored on the enterprise system.

### SUMMARY

The present disclosure includes a method comprising of a system or process that entails encrypting sensitive data, generating a token comprising a data identifier, tokenizing the encrypted sensitive data, and/or storing the encrypted sensitive data in association with the token to a token vault. Tokenizing may comprise mapping the encrypted sensitive data to the token. The method may further comprise storing the token to a cloud application, wherein the cloud application comprises a software application that functions within a cloud computing environment. In addition, the token comprises a randomly generated value. Moreover, the system may retrieve the token from a cloud application and/or identify the encrypted sensitive data, based upon a token associated with the encrypted sensitive data. The system may also decrypt the encrypted sensitive data and present it to the user.

The present disclosure further includes a method for encrypting a sensitive document. The method may include encrypting the sensitive document to create an encrypted sensitive document, generating a token comprising a document identifier, tokenizing the encrypted sensitive document, and/or storing the encrypted sensitive document to a local file storage system. Tokenizing may comprise associ-

2

ating the token with the encrypted sensitive document, and a token may comprise a file path. The method may also include storing the token to a cloud application, wherein the cloud application that comprises a software application that functions within a cloud computing environment. The method may, in addition, comprise receiving a request for the sensitive document. The method may include receiving the token from a cloud application and/or identifying the encrypted sensitive document, based upon a token associated with the encrypted sensitive document. The system may also decrypt the encrypted sensitive document and present it to the user.

### BRIEF DESCRIPTION OF THE DRAWINGS

The features and advantages of the present disclosure will become more apparent from the detailed description set forth below when taken in conjunction with the drawings. The left-most digit of a reference number identifies the drawing in which the reference number first appears.

FIG. 1A illustrates, in accordance with various embodiments, a system for protecting a sensitive document;

FIG. 1B illustrates, in accordance with various embodiments, a system for protecting sensitive data;

FIG. 2A illustrates, in accordance with various embodiments, a process for protecting a sensitive document; and

FIG. 2B illustrates, in accordance with various embodiments, a process for protecting sensitive data.

### DETAILED DESCRIPTION

The detailed description of exemplary embodiments herein makes reference to the accompanying drawings, which show the exemplary embodiments by way of illustration and their best mode. While these exemplary embodiments are described in sufficient detail to enable those skilled in the art to practice the disclosure, it should be understood that other embodiments may be realized and that logical and mechanical changes may be made without departing from the spirit and scope of the disclosure. Thus, the detailed description herein is presented for purposes of illustration only and not of limitation. For example, the steps recited in any of the method or process descriptions may be executed in any order and are not limited to the order presented. Moreover, any of the functions or steps may be outsourced to or performed by one or more third parties. Furthermore, any reference to singular includes plural embodiments, and any reference to more than one component may include a singular embodiment.

As used herein, a “document” may comprise any record (e.g., electronic record) that provides, comprises, and/or includes information. A document may, in various embodiments, be referenced and accessed by a file path associated with the document (e.g., C:/mydocuments/patent applications/systems and methods for document and data protection).

As used herein, “data” (or a “data element”) may comprise any information whatsoever. Thus, data may not be accessible, as above, via a file path. Rather, data may comprise, for example, a transaction account (credit card) number, expiry date, and the like.

As used herein, a document or data may be “tokenized” by associating an identifier with the document and/or data. For example, a document may be tokenized by associating a file path or “token” with the document. The file path may comprise the directory location of the document within a file storage system. Data may likewise be tokenized by associ-

3

ating an identifier or “token” with the data. A token may, in various embodiments, comprise a random number, which may be associated with the data.

Referring to FIG. 1A, a system **100A** for protecting a sensitive document is shown. The system **100A** may comprise a web-client **102**, a gateway **104**, a cloud application **106**, and/or a file storage system **108**.

A web-client **102** may include any device (e.g., personal computing device/mobile communication device) which communicates via any network. A web-client **102** may communicate (e.g., via a network) with a gateway **104**. Web-client **102** may be associated with and/or used by a consumer, a merchant, or both. Web-client may comprise a variety of browsing software or browser applications (e.g., Microsoft Internet Explorer, Mozilla Firefox, Google Chrome, Apple Safari, or any other of the myriad software packages available for browsing the internet). Such browser applications may comprise Internet browsing software installed within a computing unit or a system to conduct online transactions and/or communications. These computing units or systems may take the form of a computer or processor, or a set of computers/processors, although other types of computing units or systems may be used, including laptops, notebooks, hand held computers, personal digital assistants, cellular phones, smart phones (e.g., iPhone®, BlackBerry®, Droid®, etc.) set-top boxes, workstations, computer-servers, main frame computers, mini-computers, PC servers, pervasive computers, network sets of computers, personal computers, such as iPads, iMACs, and MacBooks, kiosks, terminals, point of sale (POS) devices and/or terminals, televisions, or any other device capable of receiving data over a network.

As those skilled in the art will appreciate, web-client **102** may include an operating system (e.g., Windows NT, 95/98/2000/CE/Mobile, OS2, UNIX, Linux, Solaris, MacOS, PalmOS, etc.) as well as various conventional support software and drivers typically associated with computers. A web-client may implement security protocols such as Secure Sockets Layer (SSL) and Transport Layer Security (TLS). A web-client may implement one or more application layer protocols, including, for example, http, https, ftp, and sftp. Transactions originating at a web client may pass through a firewall (not shown; see below) in order to prevent unauthorized access from users of other networks.

A gateway **104** may comprise any hardware and/or software configured to communicate with a cloud application **106**, a web-client **102**, a file storage system **108**, and/or a transaction vault **110**, as described below. For example, a gateway **104** may perform encryption/decryption operations as well as tokenize a document and/or data.

Encryption may be performed by way of any of the techniques now available in the art or which may become available—e.g., Twofish, RSA, El Gamal, Schorr signature, DSA, PGP, PKI, and symmetric and asymmetric cryptosystems.

A cloud application **106** may comprise any software application that functions within a cloud computing environment. Briefly, a cloud computing environment may comprise a network of remote servers hosted on the internet to store, manage, and/or process data. Thus, a cloud computing environment may serve, for example, to replace one or more local servers or personal computers.

A file storage system **108** may comprise any combination of hardware and/or software configured to store documents and/or data. For example, a file storage system **108** may comprise one or more databases, hard disk drives, and the like.

4

With reference now to FIG. 1B, a system **100B** for protecting sensitive data is shown. The system may comprise a web-client **102**. Similarly, the system may comprise a gateway **104** as well as one or more cloud applications **106**. The system **100B** may further comprise a token vault **110**.

A token vault **110** may comprise a data storage system, such as one or more databases, that store one or more tokens. As described herein, a document and/or data may be associated with a token—“tokenized.” Where data is tokenized, the token associated with the data may be stored securely within the token vault **110**. A mapping table may be stored within the token vault **110** to map data to its corresponding token.

With reference to FIG. 2A, an example process **200A** for protecting one or more sensitive documents is disclosed. Returning briefly to the definition of document, a document may be referenced and accessed by a file path associated with the document (e.g., C:/mydocuments/patent applications/systems and methods for document and data protection).

Accordingly, to protect the document, a user of a web-client **102** may upload the document to a cloud application **106** residing within a cloud computing environment and/or a gateway **104** (step **202A**). The gateway **104** may receive the document (step **204A**) and/or encrypt the document (step **206A**). In response to encrypting the document, the gateway **104** may tokenize the document by associating the file or directory path of the document with the document. This document token may be stored by the gateway **104** (e.g., via a network) to a cloud application **106** (step **208A**). The gateway **104** may further store the encrypted document to the file storage system **108**.

In response to a request by a user for a particular document (e.g., via the web-client **102**) (step **212A**), the gateway may retrieve the token associated with the document from the cloud application **106** (step **214A**). This may occur, for example, in response to a request from the gateway for the token from the cloud application **106**. In various embodiments, the gateway **104** may “de-tokenize” the token, meaning that the gateway **104** may read and/or store the file or directory path comprising the token. The gateway **104** may further request, retrieve, and/or receive the encrypted document associated with the token from the file storage system **108** (step **216A**). The gateway **104** may, in addition, decrypt the encrypted document (step **218A**), and communicate the decrypted document to the user (step **220A**).

With reference now to FIG. 2B, a process **200B** for protecting sensitive data is shown. In various embodiments, a user may upload, using a web-client **102**, data to the gateway **104** (step **202B**). The gateway **104** may receive the data (step **204B**). In response to receiving the data, the gateway **104** may encrypt the data and/or store it to the token vault **110** (step **206B**). The gateway may further tokenize the data (step **208B**). For example, the gateway **104** may generate a random number or “token,” and associate that token with the encrypted data stored in the token vault **110**. As described herein, the token vault **110** may include a mapping table (or other data structure, such as a database, suitable for storing a mapping between one or more tokens and one or more encrypted data elements). The token may therefore be stored by the gateway **104** with its associated mapping in the mapping table held within the token vault **110**. The gateway **104** may upload one or more tokens associated with one or more data elements to the cloud application **106** (step **210B**).

In various embodiments, the user may request data (e.g., using the web-client **102**) (step **212B**). The gateway **104** may receive this request and retrieve one or more tokens

associated with the requested data from the cloud application 106 (step 214B). The gateway 104 may de-tokenize the token to retrieve the encrypted data from the token vault 110 (step 216B). As described herein, the process of de-tokenization may simply comprise locating, within the mapping table, the data stored in association with the token or tokens. The gateway 104 may further decrypt the data retrieved from the token vault 110 (step 218B). In response to decrypting the data, the gateway 104 may communicate the data to the user's web-client 102 (step 220B).

Thus, the systems and methods 100A, 100B, 200A, and 200B may mitigate the data insecurities and problems associated with many conventional systems. For example, although a conventional system may store a token to a cloud application, the system may leave the documents and/or data associated with the token unencrypted and open to theft by a hacker. Moreover, where a conventional system may leave the documents and data unencrypted, the systems and methods 100A, 100B, 200A, and 200B may encrypt the documents and data, so that even a compromised token (e.g., in the case of data) will lead to unsuccessful data theft. Further still, the systems and methods 100A, 100B, 200A, and 200B described herein permit the storage of encrypted documents and data across international borders, as described above, as well as the storage of documents and data greater than a particular size accepted by a cloud provider.

As used herein, the term "network" includes any cloud, cloud computing system or electronic communications system or method which incorporates hardware and/or software components. Communication among the parties may be accomplished through any suitable communication channels, such as, for example, a telephone network, an extranet, an intranet, Internet, point of interaction device (point of sale device, personal digital assistant (e.g., iPhone®, Palm Pilot®, Blackberry®), cellular phone, kiosk, etc.), online communications, satellite communications, off-line communications, wireless communications, transponder communications, local area network (LAN), wide area network (WAN), virtual private network (VPN), networked or linked devices, keyboard, mouse and/or any suitable communication or data input modality. Moreover, although the system is frequently described herein as being implemented with TCP/IP communications protocols, the system may also be implemented using IPX, Appletalk, IP-6, NetBIOS, OSI, any tunneling protocol (e.g. IPsec, SSH), or any number of existing or future protocols. If the network is in the nature of a public network, such as the Internet, it may be advantageous to presume the network to be insecure and open to eavesdroppers. Specific information related to the protocols, standards, and application software utilized in connection with the Internet is generally known to those skilled in the art and, as such, need not be detailed herein. See, for example, DILIP NAIK, INTERNET STANDARDS AND PROTOCOLS (1998); JAVA 2 COMPLETE, various authors, (Sybex 1999); DEBORAH RAY AND ERIC RAY, MASTERING HTML 4.0 (1997); and LOSHIN, TCP/IP CLEARLY EXPLAINED (1997) and DAVID GOURLEY AND BRIAN TOTTY, HTTP, THE DEFINITIVE GUIDE (2002), the contents of which are hereby incorporated by reference. The various system components described herein may be independently, separately or collectively coupled to the network via one or more data links including, for example, a connection to an Internet Service Provider (ISP) over a local loop as is typically used in connection with standard modem communication, cable modem, Dish networks, ISDN, Digital Subscriber Line (DSL), or various wireless communication methods, see, e.g., GILBERT

HELD, UNDERSTANDING DATA COMMUNICATIONS (1996), which is hereby incorporated by reference. It is noted that the network may be implemented variously. For example, network may be implemented as an interactive television (ITV) network. The systems and methods disclosed herein contemplate the use, sale and/or distribution of any goods, services or information over any network having functionality similar to that described above with reference to network.

The various system components described herein may be independently, separately or collectively coupled to the network via one or more data links including, for example, a connection to an Internet Service Provider (ISP) over a local loop as is typically used in connection with standard modem communication, cable modem, Dish networks, ISDN, Digital Subscriber Line (DSL), or various wireless communication methods, see, e.g., GILBERT HELD, UNDERSTANDING DATA COMMUNICATIONS (1996), which is hereby incorporated by reference. It is noted that the network may be implemented variously. For example, network may be implemented as an interactive television (ITV) network. The systems and methods disclosed herein contemplate the use, sale and/or distribution of any goods, services or information over any network having functionality similar to that described above with reference to network.

Phrases and terms similar to a "transaction account holder," "buyer," "participant," "consumer," and/or "user" may include any person, entity, software and/or hardware that receives items in exchange for consideration (e.g. financial payment). For example, a buyer may purchase, lease, rent, barter or otherwise obtain items from a supplier and pay the supplier using a transaction account.

As used herein, "transmit" may include sending electronic data from one system component to another over a network connection. Additionally, as used herein, "data" may include encompassing information such as commands, queries, files, data for storage, and the like in digital or any other form.

Phrases or terms similar to "transaction account" may include any account that may be used to facilitate a financial transaction. A "transaction account" as used herein refers to an account associated with an open account or a closed account system (as described herein). The transaction account may exist in a physical or non-physical embodiment. For example, a transaction account may be distributed in non-physical embodiments such as an account number, frequent-flyer account, and telephone calling account or the like. Furthermore, a physical embodiment of a transaction account may be distributed as a financial instrument.

In general, transaction accounts may be used for transactions between the user (or "transaction account holder") and merchant through any suitable communication means, such as, for example, a telephone network, intranet, the global, public Internet, a point of interaction device (e.g., a point of sale (POS) device, personal digital assistant (PDA), mobile telephone, kiosk, etc.), online communications, off-line communications, wireless communications, and/or the like.

Phrases and terms similar to an "item" may include any good, service, information, experience, data, discount, rebate, points, virtual currency, content, access, rental, lease, contribution, account, credit, debit, benefit, right, reward, points, coupons, credits, monetary equivalent, anything of value, something of minimal or no value, monetary value, non-monetary value and/or the like. Moreover, the "transactions" or "purchases" discussed herein may be associated with an item. Furthermore, a "reward" may be an item.



An “account”, “account code”, or “account number”, as used herein, may include any device, code, number, letter, symbol, digital certificate, smart chip, digital signal, analog signal, biometric or other identifier/indicia suitably configured to allow the consumer to access, interact with or communicate with the system (e.g., one or more of an authorization/access code, personal identification number (PIN), Internet code, other identification code, and/or the like). The account number may optionally be located on or associated with a rewards card, charge card, credit card, debit card, prepaid card, telephone card, embossed card, smart card, magnetic stripe card, bar code card, transponder, radio frequency card or an associated account. The system may include or interface with any of the foregoing cards or devices, QR codes, Bluetooth, Near Field Communication, or a transponder and RFID reader in RF communication with the transponder (which may include a fob). Typical devices may include, for example, a key ring, tag, card, cell phone, wristwatch or any such form capable of being presented for interrogation.

As used herein, a system, computing unit or device may include a “pervasive computing device,” which may include a traditionally non-computerized device that is embedded with a computing unit. Examples can include watches, Internet enabled kitchen appliances, restaurant tables embedded with RF readers, wallets or purses with imbedded transponders, etc.

The account code may be distributed and stored in any form of plastic, electronic, magnetic, radio frequency, wireless, audio and/or optical device capable of transmitting or downloading data from itself to a second device. A customer account code may be, for example, a sixteen-digit transaction account code, although each transaction account provider has its own numbering system, such as the fifteen-digit numbering system used by American Express. Each company’s transaction account codes comply with that company’s standardized format such that the company using a fifteen-digit format will generally use three-spaced sets of numbers, as represented by the number “0000 00000 00000”. The first five to seven digits are reserved for processing purposes and identify the issuing bank, card type, etc. In this example, the last (fifteenth) digit is used as a sum check for the fifteen digit number. The intermediary eight-to-eleven digits are used to uniquely identify the customer. A merchant account code may be, for example, any number or alpha-numeric characters that identify a particular merchant for purposes of card acceptance, account reconciliation, reporting, or the like.

It should be noted that the transfer of information in accordance with the present disclosure, may be completed in a format recognizable by a merchant system or account issuer. In that regard, by way of example, the information may be transmitted from a contactless (e.g., an RFID device) to a contactless (e.g., RFID) reader or from the contactless reader to the merchant system in a variety of formats, e.g., magnetic stripe or multi-track magnetic stripe format.

As used herein, phrases and terms similar to “financial institution,” “transaction account issuer” and “payment processor” may include any person, entity, software and/or hardware that offers transaction account services. Although often referred to as a “financial institution,” the financial institution may represent any type of bank, lender or other type of account issuing institution, such as credit card companies, card sponsoring companies, or third party issuers under contract with financial institutions. It is further

noted that other participants may be involved in some phases of the transaction, such as an intermediary settlement institution.

The terms “payment vehicle,” “financial transaction instrument,” “transaction instrument,” or “transaction account product” may be used interchangeably throughout to refer to a financial instrument. As used herein, an account code may or may not be associated with a physical financial instrument.

In the detailed description herein, references to “one embodiment”, “an embodiment”, “an example embodiment”, “various embodiments”, etc., indicate that the embodiment described may include a particular feature, structure, or characteristic, but every embodiment may not necessarily include the particular feature, structure, or characteristic. Moreover, such phrases are not necessarily referring to the same embodiment. Further, when a particular feature, structure, or characteristic is described in connection with an embodiment, it is submitted that it is within the knowledge of one skilled in the art to effect such feature, structure, or characteristic in connection with other embodiments whether or not explicitly described. After reading the description, it will be apparent to one skilled in the relevant art(s) how to implement the disclosure in certain embodiments.

In various embodiments, the methods described herein are implemented using the various particular machines described herein. The methods described herein may be implemented using the particular machines, and those hereinafter developed, in any suitable combination, as would be appreciated immediately by one skilled in the art. Further, as is unambiguous from this disclosure, the methods described herein may result in various transformations of certain articles.

For the sake of brevity, conventional data networking, application development and other functional aspects of the systems (and components of the individual operating components of the systems) may not be described in detail herein. Furthermore, the connecting lines shown in the various figures contained herein are intended to represent exemplary functional relationships and/or physical couplings between the various elements. It should be noted that many alternative or additional functional relationships or physical connections may be present in a practical system.

The various system components discussed herein may include one or more of the following: a host server or other computing systems including a processor for processing digital data; a memory coupled to the processor for storing digital data; an input digitizer coupled to the processor for inputting digital data; an application program stored in the memory and accessible by the processor for directing processing of digital data by the processor; a display device coupled to the processor and memory for displaying information derived from digital data processed by the processor; and a plurality of databases. Various databases used herein may include: client data; merchant data; financial institution data; and/or like data useful in the operation of the system. As those skilled in the art will appreciate, user computer may include an operating system (e.g., Windows NT, 95/98/2000, XP, Vista, OS2, UNIX, Linux, Solaris, MacOS, etc.) as well as various conventional support software and drivers typically associated with computers. A user may include any individual, business, entity, government organization, software and/or hardware that interact with a system.

In an embodiment, various components, modules, and/or engines of the systems described herein may be implemented as micro-applications or micro-apps. Micro-apps are

typically deployed in the context of a mobile operating system, including for example, a Palm mobile operating system, a Windows mobile operating system, an Android Operating System, Apple iOS, a Blackberry operating system and the like. The micro-app may be configured to leverage the resources of the larger operating system and associated hardware via a set of predetermined rules which govern the operations of various operating systems and hardware resources. For example, where a micro-app desires to communicate with a device or network other than the mobile device or mobile operating system, the micro-app may leverage the communication protocol of the operating system and associated device hardware under the predetermined rules of the mobile operating system. Moreover, where the micro-app desires an input from a user, the micro-app may be configured to request a response from the operating system which monitors various hardware components and then communicates a detected input from the hardware to the micro-app.

The system contemplates uses in association with web services, utility computing, pervasive and individualized computing, security and identity solutions, autonomic computing, cloud computing, commodity computing, mobility and wireless solutions, open source, biometrics, grid computing and/or mesh computing.

Any databases discussed herein may include relational, hierarchical, graphical, or object-oriented structure and/or any other database configurations. Common database products that may be used to implement the databases include DB2 by IBM (Armonk, N.Y.), various database products available from Oracle Corporation (Redwood Shores, Calif.), Microsoft Access or Microsoft SQL Server by Microsoft Corporation (Redmond, Wash.), MySQL by MySQL AB (Uppsala, Sweden), or any other suitable database product. Moreover, the databases may be organized in any suitable manner, for example, as data tables or lookup tables. Each record may be a single file, a series of files, a linked series of data fields or any other data structure. Association of certain data may be accomplished through any desired data association technique such as those known or practiced in the art. For example, the association may be accomplished either manually or automatically. Automatic association techniques may include, for example, a database search, a database merge, GREP, AGREP, SQL, using a key field in the tables to speed searches, sequential searches through all the tables and files, sorting records in the file according to a known order to simplify lookup, and/or the like. The association step may be accomplished by a database merge function, for example, using a "key field" in pre-selected databases or data sectors. Various database tuning steps are contemplated to optimize database performance. For example, frequently used files such as indexes may be placed on separate file systems to reduce In/Out ("I/O") bottlenecks.

More particularly, a "key field" partitions the database according to the high-level class of objects defined by the key field. For example, certain types of data may be designated as a key field in a plurality of related data tables and the data tables may then be linked on the basis of the type of data in the key field. The data corresponding to the key field in each of the linked data tables is preferably the same or of the same type. However, data tables having similar, though not identical, data in the key fields may also be linked by using AGREP, for example. In accordance with one embodiment, any suitable data storage technique may be utilized to store data without a standard format. Data sets may be stored using any suitable technique, including, for

example, storing individual files using an ISO/IEC 7816-4 file structure; implementing a domain whereby a dedicated file is selected that exposes one or more elementary files containing one or more data sets; using data sets stored in individual files using a hierarchical filing system; data sets stored as records in a single file (including compression, SQL accessible, hashed via one or more keys, numeric, alphabetical by first tuple, etc.); Binary Large Object (BLOB); stored as ungrouped data elements encoded using ISO/IEC 7816-6 data elements; stored as ungrouped data elements encoded using ISO/IEC Abstract Syntax Notation (ASN.1) as in ISO/IEC 8824 and 8825; and/or other proprietary techniques that may include fractal compression methods, image compression methods, etc.

In one exemplary embodiment, the ability to store a wide variety of information in different formats is facilitated by storing the information as a BLOB. Thus, any binary information can be stored in a storage space associated with a data set. As discussed above, the binary information may be stored on the financial transaction instrument or external to but affiliated with the financial transaction instrument. The BLOB method may store data sets as ungrouped data elements formatted as a block of binary via a fixed memory offset using either fixed storage allocation, circular queue techniques, or best practices with respect to memory management (e.g., paged memory, least recently used, etc.). By using BLOB methods, the ability to store various data sets that have different formats facilitates the storage of data associated with the financial transaction instrument by multiple and unrelated owners of the data sets. For example, a first data set which may be stored may be provided by a first party, a second data set which may be stored may be provided by an unrelated second party, and yet a third data set which may be stored, may be provided by an third party unrelated to the first and second party. Each of these three exemplary data sets may contain different information that is stored using different data storage formats and/or techniques. Further, each data set may contain subsets of data that also may be distinct from other subsets.

As stated above, in various embodiments, the data can be stored without regard to a common format. However, in one exemplary embodiment, the data set (e.g., BLOB) may be annotated in a standard manner when provided for manipulating the data onto the financial transaction instrument. The annotation may comprise a short header, trailer, or other appropriate indicator related to each data set that is configured to convey information useful in managing the various data sets. For example, the annotation may be called a "condition header", "header", "trailer", or "status", herein, and may comprise an indication of the status of the data set or may include an identifier correlated to a specific issuer or owner of the data. In one example, the first three bytes of each data set BLOB may be configured or configurable to indicate the status of that particular data set; e.g., LOADED, INITIALIZED, READY, BLOCKED, REMOVABLE, or DELETED. Subsequent bytes of data may be used to indicate for example, the identity of the issuer, user, transaction/membership account identifier or the like. Each of these condition annotations are further discussed herein.

The data set annotation may also be used for other types of status information as well as various other purposes. For example, the data set annotation may include security information establishing access levels. The access levels may, for example, be configured to permit only certain individuals, levels of employees, companies, or other entities to access data sets, or to permit access to specific data sets based on the transaction, merchant, issuer, user or the like. Further-

more, the security information may restrict/permit only certain actions such as accessing, modifying, and/or deleting data sets. In one example, the data set annotation indicates that only the data set owner or the user are permitted to delete a data set, various identified users may be permitted to access the data set for reading, and others are altogether excluded from accessing the data set. However, other access restriction parameters may also be used allowing various entities to access a data set with various permission levels as appropriate.

The data, including the header or trailer may be received by a stand alone interaction device configured to add, delete, modify, or augment the data in accordance with the header or trailer. As such, in one embodiment, the header or trailer is not stored on the transaction device along with the associated issuer-owned data but instead the appropriate action may be taken by providing to the transaction instrument user at the stand alone device, the appropriate option for the action to be taken. The system may contemplate a data storage arrangement wherein the header or trailer, or header or trailer history, of the data is stored on the transaction instrument in relation to the appropriate data.

One skilled in the art will also appreciate that, for security reasons, any databases, systems, devices, servers or other components of the system may consist of any combination thereof at a single location or at multiple locations, wherein each database or system includes any of various suitable security features, such as firewalls, access codes, encryption, decryption, compression, decompression, and/or the like.

A firewall may comprise any hardware and/or software suitably configured to protect systems, components, and/or enterprise computing resources from users of other networks. Further, a firewall may be configured to limit or restrict access to various systems and components behind the firewall for web clients connecting through a web server. A firewall may reside in varying configurations including Stateful Inspection, Proxy based, access control lists, and Packet Filtering among others. A firewall may be integrated within a web server or any other CMS components or may further reside as a separate entity. A firewall may implement network address translation ("NAT") and/or network address port translation ("NAPT"). A firewall may accommodate various tunneling protocols to facilitate secure communications, such as those used in virtual private networking. A firewall may implement a demilitarized zone ("DMZ") to facilitate communications with a public network such as the Internet. A firewall may be integrated as software within an Internet server, any other application server components or may reside within another computing device or may take the form of a standalone hardware component.

The computers discussed herein may provide a suitable website or other Internet-based graphical user interface which is accessible by users. In one embodiment, the Microsoft Internet Information Server (IIS), Microsoft Transaction Server (MTS), and Microsoft SQL Server, are used in conjunction with the Microsoft operating system, Microsoft NT web server software, a Microsoft SQL Server database system, and a Microsoft Commerce Server. Additionally, components such as Access or Microsoft SQL Server, Oracle, Sybase, Informix MySQL, Interbase, etc., may be used to provide an Active Data Object (ADO) compliant database management system. In one embodiment, the Apache web server is used in conjunction with a Linux operating system, a MySQL database, and the Perl, PHP, and/or Python programming languages.

Any of the communications, inputs, storage, databases or displays discussed herein may be facilitated through a website having web pages. The term "web page" as it is used herein is not meant to limit the type of documents and applications that might be used to interact with the user. For example, a typical website might include, in addition to standard HTML documents, various forms, Java applets, JavaScript, active server pages (ASP), common gateway interface scripts (CGI), extensible markup language (XML), dynamic HTML, cascading style sheets (CSS), AJAX (Asynchronous Javascript And XML), helper applications, plug-ins, and the like. A server may include a web service that receives a request from a web server, the request including a URL (<http://yahoo.com/stockquotes/ge>) and an IP address (123.56.789.234). The web server retrieves the appropriate web pages and sends the data or applications for the web pages to the IP address. Web services are applications that are capable of interacting with other applications over a communications means, such as the internet. Web services are typically based on standards or protocols such as XML, SOAP, AJAX, WSDL and UDDI. Web services methods are well known in the art, and are covered in many standard texts. See, e.g., ALEX NGHIEM, IT WEB SERVICES: A ROADMAP FOR THE ENTERPRISE (2003), hereby incorporated by reference.

Middleware may include any hardware and/or software suitably configured to facilitate communications and/or process transactions between disparate computing systems. Middleware components are commercially available and known in the art. Middleware may be implemented through commercially available hardware and/or software, through custom hardware and/or software components, or through a combination thereof. Middleware may reside in a variety of configurations and may exist as a standalone system or may be a software component residing on the Internet server. Middleware may be configured to process transactions between the various components of an application server and any number of internal or external systems for any of the purposes disclosed herein. WebSphere MQTM (formerly MQSeries) by IBM, Inc. (Armonk, N.Y.) is an example of a commercially available middleware product. An Enterprise Service Bus ("ESB") application is another example of middleware.

Practitioners will also appreciate that there are a number of methods for displaying data within a browser-based document. Data may be represented as standard text or within a fixed list, scrollable list, drop-down list, editable text field, fixed text field, pop-up window, and the like. Likewise, there are a number of methods available for modifying data in a web page such as, for example, free text entry using a keyboard, selection of menu items, check boxes, option boxes, and the like.

The system and method may be described herein in terms of functional block components, screen shots, optional selections and various processing steps. It should be appreciated that such functional blocks may be realized by any number of hardware and/or software components configured to perform the specified functions. For example, the system may employ various integrated circuit components, e.g., memory elements, processing elements, logic elements, lookup tables, and the like, which may carry out a variety of functions under the control of one or more microprocessors or other control devices. Similarly, the software elements of the system may be implemented with any programming or scripting language such as C, C++, C#, Java, JavaScript, VBScript, Macromedia Cold Fusion, COBOL, Microsoft Active Server Pages, assembly, PERL, PHP, awk, Python,

Visual Basic, SQL Stored Procedures, PL/SQL, any UNIX shell script, and extensible markup language (XML) with the various algorithms being implemented with any combination of data structures, objects, processes, routines or other programming elements. Further, it should be noted that the system may employ any number of conventional techniques for data transmission, signaling, data processing, network control, and the like. Still further, the system could be used to detect or prevent security issues with a client-side scripting language, such as JavaScript, VBScript or the like. For a basic introduction of cryptography and network security, see any of the following references: (1) "Applied Cryptography: Protocols, Algorithms, And Source Code In C," by Bruce Schneier, published by John Wiley & Sons (second edition, 1995); (2) "Java Cryptography" by Jonathan Knudson, published by O'Reilly & Associates (1998); (3) "Cryptography & Network Security: Principles & Practice" by William Stallings, published by Prentice Hall; all of which are hereby incorporated by reference.

Each participant is equipped with a computing device in order to interact with the system and facilitate online commerce transactions. The customer has a computing unit in the form of a personal computer, although other types of computing units may be used including laptops, notebooks, hand held computers, set-top boxes, cellular telephones, touch-tone telephones and the like. The merchant has a computing unit implemented in the form of a computer-server, although other implementations are contemplated by the system. The bank has a computing center shown as a main frame computer. However, the bank computing center may be implemented in other forms, such as a mini-computer, a PC server, a network of computers located in the same of different geographic locations, or the like. Moreover, the system contemplates the use, sale or distribution of any goods, services or information over any network having similar functionality described herein.

The electronic commerce system may be implemented at the customer and issuing bank. In an exemplary implementation, the electronic commerce system is implemented as computer software modules loaded onto the customer computer and the banking computing center. The merchant computer does not require any additional software to participate in the online commerce transactions supported by the online commerce system.

As will be appreciated by one of ordinary skill in the art, the system may be embodied as a customization of an existing system, an add-on product, upgraded software, a stand alone system, a distributed system, a method, a data processing system, a device for data processing, and/or a computer program product. Accordingly, the system may take the form of an entirely software embodiment, an entirely hardware embodiment, or an embodiment combining aspects of both software and hardware. Furthermore, the system may take the form of a computer program product on a computer-readable storage medium having computer-readable program code means embodied in the storage medium. Any suitable computer-readable storage medium may be utilized, including hard disks, CD-ROM, optical storage devices, magnetic storage devices, and/or the like.

The system and method is described herein with reference to screen shots, block diagrams and flowchart illustrations of methods, apparatus (e.g., systems), and computer program products according to various embodiments. It will be understood that each functional block of the block diagrams and the flowchart illustrations, and combinations of func-

tional blocks in the block diagrams and flowchart illustrations, respectively, can be implemented by computer program instructions.

These computer program instructions may be loaded onto a general purpose computer, special purpose computer, or other programmable data processing apparatus to produce a machine, such that the instructions that execute on the computer or other programmable data processing apparatus create means for implementing the functions specified in the flowchart block or blocks. These computer program instructions may also be stored in a computer-readable memory that can direct a computer or other programmable data processing apparatus to function in a particular manner, such that the instructions stored in the computer-readable memory produce an article of manufacture including instruction means which implement the function specified in the flowchart block or blocks. The computer program instructions may also be loaded onto a computer or other programmable data processing apparatus to cause a series of operational steps to be performed on the computer or other programmable apparatus to produce a computer-implemented process such that the instructions which execute on the computer or other programmable apparatus provide steps for implementing the functions specified in the flowchart block or blocks.

Accordingly, functional blocks of the block diagrams and flowchart illustrations support combinations of means for performing the specified functions, combinations of steps for performing the specified functions, and program instruction means for performing the specified functions. It will also be understood that each functional block of the block diagrams and flowchart illustrations, and combinations of functional blocks in the block diagrams and flowchart illustrations, can be implemented by either special purpose hardware-based computer systems which perform the specified functions or steps, or suitable combinations of special purpose hardware and computer instructions. Further, illustrations of the process flows and the descriptions thereof may make reference to user windows, webpages, websites, web forms, prompts, etc. Practitioners will appreciate that the illustrated steps described herein may comprise in any number of configurations including the use of windows, webpages, web forms, popup windows, prompts and the like. It should be further appreciated that the multiple steps as illustrated and described may be combined into single webpages and/or windows but have been expanded for the sake of simplicity. In other cases, steps illustrated and described as single process steps may be separated into multiple webpages and/or windows but have been combined for simplicity.

Benefits, other advantages, and solutions to problems have been described herein with regard to specific embodiments. However, the benefits, advantages, solutions to problems, and any elements that may cause any benefit, advantage, or solution to occur or become more pronounced are not to be construed as critical, required, or essential features or elements of the disclosure. The scope of the disclosure is accordingly to be limited by nothing other than the appended claims, in which reference to an element in the singular is not intended to mean "one and only one" unless explicitly so stated, but rather "one or more." Moreover, where a phrase similar to "at least one of A, B, and C" or "at least one of A, B, or C" is used in the claims or specification, it is intended that the phrase be interpreted to mean that A alone may be present in an embodiment, B alone may be present in an embodiment, C alone may be present in an embodiment, or that any combination of the elements A, B and C may be

15

present in a single embodiment; for example, A and B, A and C, B and C, or A and B and C. Although the inventions have been described as a method in certain embodiments, it is contemplated that it may be embodied as computer program instructions on a tangible computer-readable carrier, such as a magnetic or optical memory or a magnetic or optical disk. All structural, chemical, and functional equivalents to the elements of the above-described exemplary embodiments that are known to those of ordinary skill in the art are expressly incorporated herein by reference and are intended to be encompassed by the present claims. Moreover, it is not necessary for a device or method to address each and every problem sought to be solved by the present disclosure, for it to be encompassed by the present claims. Furthermore, no element, component, or method step in the present disclosure is intended to be dedicated to the public regardless of whether the element, component, or method step is explicitly recited in the claims. No claim element herein is to be construed under the provisions of 35 U.S.C. 112(f) unless the element is expressly recited using the phrase “means for.” As used herein, the terms “comprises”, “comprising”, or any other variation thereof, are intended to cover a non-exclusive inclusion, such that a process, method, article, or apparatus that comprises a list of elements does not include only those elements but may include other elements not expressly listed or inherent to such process, method, article, or apparatus.

What is claimed is:

1. A method comprising:

intercepting, by a tokenization gateway computer-based system, sensitive data prior to the sensitive data reaching a cloud application in an externally hosted system, wherein the sensitive data is being uploaded to the externally hosted system;

encrypting, by the tokenization gateway computer-based system and in response to the intercepting, the sensitive data to create encrypted sensitive data;

associating, by the tokenization gateway computer-based system, a file path with the encrypted sensitive data;

generating, by the tokenization gateway computer-based system and in response to the encrypting, a token comprising a data identifier;

tokenizing, by the tokenization gateway computer-based system and in response to the generating, the encrypted sensitive data, wherein the tokenizing comprises mapping the encrypted sensitive data to the token;

storing, by the tokenization gateway computer-based system and in response to the tokenizing, the token to the cloud application, wherein the cloud application comprises a software application that functions within the externally hosted system, wherein the externally hosted system includes a cloud computing environment;

storing, by the tokenization gateway computer-based system and in response to the storing the token to the cloud application, the encrypted sensitive data to a token vault internal to the tokenization gateway computer-based system, wherein the token vault comprises a data storage system;

retrieving, by the tokenization gateway computer-based system, the token from the cloud application in response to a request from the computer-based system for the token from the cloud application,

reading, by the tokenization gateway computer-based system, the file path associated with the token; and

16

in response to the reading the file path associated with the token, receiving and decrypting, by the tokenization gateway computer-based system, the encrypted sensitive data.

2. The method of claim 1, wherein the token comprises the file path, wherein the file path comprises a directory location of the encrypted sensitive data within the data storage system.

3. The method of claim 2, wherein the token comprises a randomly generated value, and wherein a mapping table is stored in the token vault, wherein the mapping table maps the encrypted sensitive data to the token.

4. The method of claim 3, further comprising receiving, by the tokenization gateway computer-based system, a request for the sensitive data.

5. The method of claim 1, further comprising identifying, based upon the token associated with the encrypted sensitive data, the encrypted sensitive data.

6. A system comprising:

a tangible, non-transitory memory communicating with a tokenization gateway processor,

the tangible, non-transitory memory having instructions stored thereon that, in response to execution by the tokenization gateway processor, cause the tokenization gateway processor to perform operations comprising: intercepting, by the tokenization gateway processor, sensitive data prior to the sensitive data reaching a cloud application in an externally hosted system,

wherein the sensitive data is being uploaded to the externally hosted system;

encrypting, by the tokenization gateway processor and in response to the intercepting, the sensitive data to create encrypted sensitive data;

associating, by the tokenization gateway processor, a file path with the encrypted sensitive data;

generating, by the tokenization gateway processor and in response to the encrypting, a token comprising a data identifier;

tokenizing, by the tokenization gateway processor and in response to the generating, the encrypted sensitive data, wherein the tokenizing comprises mapping the encrypted sensitive data to the token;

storing, by the tokenization gateway processor and in response to the tokenizing, the token to the cloud application, wherein the cloud application comprises a software application that functions within the externally hosted system, wherein the externally hosted system includes a cloud computing environment;

storing, by the tokenization gateway processor and in response to the storing the token to the cloud application, the encrypted sensitive data to a token vault internal to the tokenization gateway processor, wherein the token vault comprises a data storage system;

retrieving, by the tokenization gateway processor, the token from the cloud application in response to a request from the tokenization gateway processor for the token from the cloud application,

reading, by the tokenization gateway processor, the file path associated with the token; and

in response to the reading the file path associated with the token, receiving and decrypting, by the tokenization gateway processor, the encrypted sensitive data.

7. The system of claim 6, wherein the token comprises the file path, wherein the file path comprises a directory location of the encrypted sensitive data within the data storage system.

17

8. The system of claim 7, wherein the token comprises a randomly generated value, and wherein a mapping table is stored in the token vault, wherein the mapping table maps the encrypted sensitive data to the token.

9. The system of claim 8, further comprising receiving, by the tokenization gateway processor, a request for the sensitive data.

10. The system of claim 6, further comprising identifying, based upon the token associated with the encrypted sensitive data, the encrypted sensitive data.

11. An article of manufacture including a non-transitory, tangible computer readable storage medium having instructions stored thereon that, in response to execution by a tokenization gateway computer-based system, cause the computer-based system to perform operations comprising:

intercepting, by the tokenization gateway computer-based system, a sensitive document prior to the sensitive document reaching a cloud application in an externally hosted system,

wherein the sensitive document is being uploaded to the externally hosted system;

encrypting, by the tokenization gateway computer-based system and in response to the intercepting, the sensitive document to create an encrypted sensitive document;

associating, by the tokenization gateway computer-based system, a file path with the encrypted sensitive document;

generating, by the tokenization gateway computer-based system and in response to the encrypting, a token comprising a document identifier;

tokenizing, by the tokenization gateway computer-based system and in response to the generating, the encrypted sensitive document, wherein the tokenizing comprises associating the token with the encrypted sensitive document;

18

storing, by the tokenization gateway computer-based system and in response to the tokenizing, the token to the cloud application, wherein the cloud application comprises a software application that functions within the externally hosted system, wherein the externally hosted system includes a cloud computing environment;

storing, by the tokenization gateway computer-based system and in response to the storing the token to the cloud application, the encrypted sensitive document to an internal to the tokenization gateway computer-based system, wherein the token vault comprises file storage system;

retrieving, by the computer-based system, the token from the cloud application in response to a request from the computer-based system for the token from the cloud application,

reading, by the tokenization gateway computer-based system, the file path associated with the token; and

in response to the reading the file path associated with the token, receiving and decrypting, by the tokenization gateway computer-based system, the encrypted sensitive document.

12. The article of claim 11, wherein the token comprises the file path, wherein the file path comprises a directory location of the encrypted sensitive document within the document storage system.

13. The article of claim 12, wherein the token comprises a randomly generated value, and wherein a mapping table is stored in the token vault, wherein the mapping table maps the encrypted sensitive document to the token.

14. The article of claim 13, further comprising receiving, by the tokenization gateway computer-based system, a request for the sensitive document.

\* \* \* \* \*



US009342832B2

(12) **United States Patent**  
**Basu et al.**

(10) **Patent No.:** **US 9,342,832 B2**  
(45) **Date of Patent:** **May 17, 2016**

(54) **SECURING EXTERNAL SYSTEMS WITH ACCOUNT TOKEN SUBSTITUTION**

*20/322* (2013.01); *G06Q 20/3674* (2013.01);  
*G06Q 20/382* (2013.01); *G06Q 20/38215*  
(2013.01)

(75) Inventors: **Gourab Basu**, Half Moon Bay, CA (US); **Michael Mori**, San Mateo, CA (US); **Ross Sakata**, Foster City, CA (US); **Steve Cracknell**, San Mateo, CA (US); **Millie Yee**, Santa Clara, CA (US); **Mark Carlson**, Half Moon Bay, CA (US); **Patrick Stan**, Pacifica, CA (US); **Surendra Keshan**, Cupertino, CA (US); **Edward Katzin**, San Francisco, CA (US)

(58) **Field of Classification Search**  
CPC ..... G06Q 20/385  
USPC ..... 705/67, 17, 44, 64, 71, 78  
See application file for complete search history.

(73) Assignee: **Visa International Service Association**, San Francisco, CA (US)

(56) **References Cited**

U.S. PATENT DOCUMENTS

5,903,652 A 5/1999 Mital  
5,903,880 A \* 5/1999 Biffar ..... G06Q 20/06  
235/379  
6,005,945 A \* 12/1999 Whitehouse ..... 380/51

(Continued)

FOREIGN PATENT DOCUMENTS

WO WO 01/09855 A1 2/2001

OTHER PUBLICATIONS

Ulf Mattsson, "The Difference between Tokenization and Encryption", Nov. 7, 2011.\*

(Continued)

(\* ) Notice: Subject to any disclaimer, the term of this patent is extended or adjusted under 35 U.S.C. 154(b) by 494 days.

(21) Appl. No.: **13/208,733**

(22) Filed: **Aug. 12, 2011**

(65) **Prior Publication Data**

US 2012/0041881 A1 Feb. 16, 2012

**Related U.S. Application Data**

(60) Provisional application No. 61/373,163, filed on Aug. 12, 2010, provisional application No. 61/381,322, filed on Sep. 9, 2010.

(51) **Int. Cl.**

**G06Q 20/00** (2012.01)  
**G06Q 20/38** (2012.01)  
**G06Q 20/02** (2012.01)  
**G06Q 20/12** (2012.01)  
**G06Q 20/32** (2012.01)  
**G06Q 20/36** (2012.01)

(52) **U.S. Cl.**

CPC ..... **G06Q 20/385** (2013.01); **G06Q 20/02**  
(2013.01); **G06Q 20/12** (2013.01); **G06Q**

(57) **ABSTRACT**

Systems, apparatuses, and methods for providing an account token to an external entity during the lifecycle of a payment transaction. In some embodiments, an external entity may be a merchant computer requesting authorization of a payment message. In other embodiments, the external entity may be a support computer providing a payment processing network or a merchant support functions.

**21 Claims, 12 Drawing Sheets**

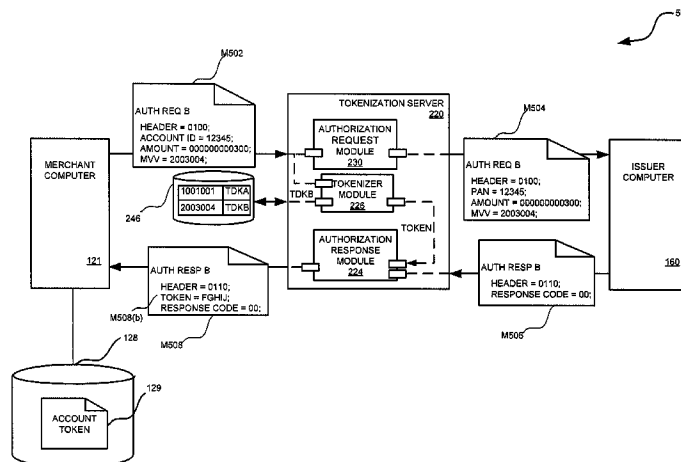

(56)

References Cited

U.S. PATENT DOCUMENTS

6,182,894 B1 2/2001 Hackett  
 6,236,981 B1\* 5/2001 Hill ..... 705/67  
 6,327,578 B1\* 12/2001 Linehan ..... 705/65  
 6,385,596 B1 5/2002 Wisner  
 6,745,936 B1\* 6/2004 Movalli ..... G06Q 20/04  
 235/379  
 6,891,953 B1 5/2005 DeMello  
 7,032,168 B1\* 4/2006 Gerace ..... G06Q 30/0277  
 705/14.73  
 7,287,692 B1 10/2007 Patel et al.  
 7,403,922 B1 7/2008 Lewis et al.  
 7,603,382 B2 10/2009 Halt, Jr.  
 7,650,314 B1 1/2010 Saunders  
 7,664,701 B2 2/2010 Phillips  
 7,757,298 B2 7/2010 Shuster  
 8,083,137 B2 12/2011 Tannenbaum  
 8,170,922 B2\* 5/2012 Cavagnaro ..... 705/26.1  
 8,381,213 B1\* 2/2013 Naamad et al. .... 718/100  
 8,402,555 B2 3/2013 Grecia  
 8,533,860 B1 9/2013 Grecia  
 8,571,995 B2\* 10/2013 Spies ..... G06Q 20/20  
 380/262  
 8,651,374 B2\* 2/2014 Brabson ..... G06Q 20/385  
 235/379  
 8,751,391 B2 6/2014 Freund  
 8,887,308 B2 11/2014 Grecia  
 9,065,643 B2\* 6/2015 Hury ..... G06Q 20/3829  
 2001/0032878 A1\* 10/2001 Tsiounis et al. .... 235/379  
 2002/0073045 A1\* 6/2002 Rubin ..... G06Q 20/04  
 705/65  
 2003/0191709 A1\* 10/2003 Elston et al. .... 705/40  
 2004/0073688 A1\* 4/2004 Sampson ..... G06F 17/30067  
 709/229  
 2004/0107170 A1\* 6/2004 Labrou et al. .... 705/64  
 2004/0143552 A1\* 7/2004 Weichert et al. .... 705/64  
 2005/0027543 A1\* 2/2005 Labrou et al. .... 705/1  
 2005/0187873 A1\* 8/2005 Labrou et al. .... 705/40  
 2006/0123465 A1 6/2006 Ziegler  
 2006/0167819 A1 7/2006 Bhambri et al.

2006/0277148 A1\* 12/2006 Thackston ..... G06Q 20/02  
 705/41  
 2007/0022058 A1\* 1/2007 Labrou et al. .... 705/67  
 2007/0050635 A1\* 3/2007 Popp ..... 713/185  
 2007/0125840 A1\* 6/2007 Law et al. .... 235/379  
 2007/0192245 A1\* 8/2007 Fisher ..... G06Q 20/02  
 705/39  
 2007/0294539 A1\* 12/2007 Shulman ..... G06F 17/30436  
 713/186  
 2008/0091617 A1 4/2008 Hazel et al.  
 2008/0091944 A1\* 4/2008 von Mueller et al. .... 713/168  
 2008/0103982 A1 5/2008 Hammad et al.  
 2008/0313264 A1 12/2008 Pestoni  
 2009/0024908 A1 1/2009 Kottke et al.  
 2009/0037388 A1 2/2009 Cooper  
 2009/0070583 A1 3/2009 Von Mueller et al.  
 2009/0228714 A1\* 9/2009 Fiske et al. .... 713/186  
 2009/0248581 A1\* 10/2009 Brown ..... 705/67  
 2009/0249082 A1\* 10/2009 Mattsson ..... 713/193  
 2009/0254440 A1\* 10/2009 Pharris ..... 705/17  
 2009/0288012 A1\* 11/2009 Hertel et al. .... 715/738  
 2010/0257612 A1\* 10/2010 McGuire et al. .... 726/26  
 2010/0318468 A1\* 12/2010 Carr ..... G06Q 20/027  
 705/79  
 2010/0327054 A1\* 12/2010 Hammad ..... G06F 21/34  
 235/375  
 2011/0106710 A1\* 5/2011 Reed et al. .... 705/71  
 2011/0126274 A1\* 5/2011 Sadeckas ..... G06F 21/335  
 726/7  
 2011/0154467 A1\* 6/2011 Bomar et al. .... 726/9  
 2011/0161233 A1\* 6/2011 Tieken ..... 705/71  
 2011/0213807 A1\* 9/2011 Mattsson ..... 707/802  
 2011/0246369 A1\* 10/2011 de Oliveira et al. .... 705/64  
 2012/0136789 A1\* 5/2012 Kendrick ..... G06Q 20/12  
 705/44  
 2012/0317036 A1\* 12/2012 Bower et al. .... 705/75

OTHER PUBLICATIONS

Petition for Inter Partes Review of U.S. Pat. No. 8,533,860 Challenging Claims 1-30 Under 35 U.S.C. § 312 and 37 C.F.R. § 42.104, filed Feb. 17, 2016, Before the USPTO Patent Trial and Appeal Board, IPR 2016-00600, 65 pages.

\* cited by examiner



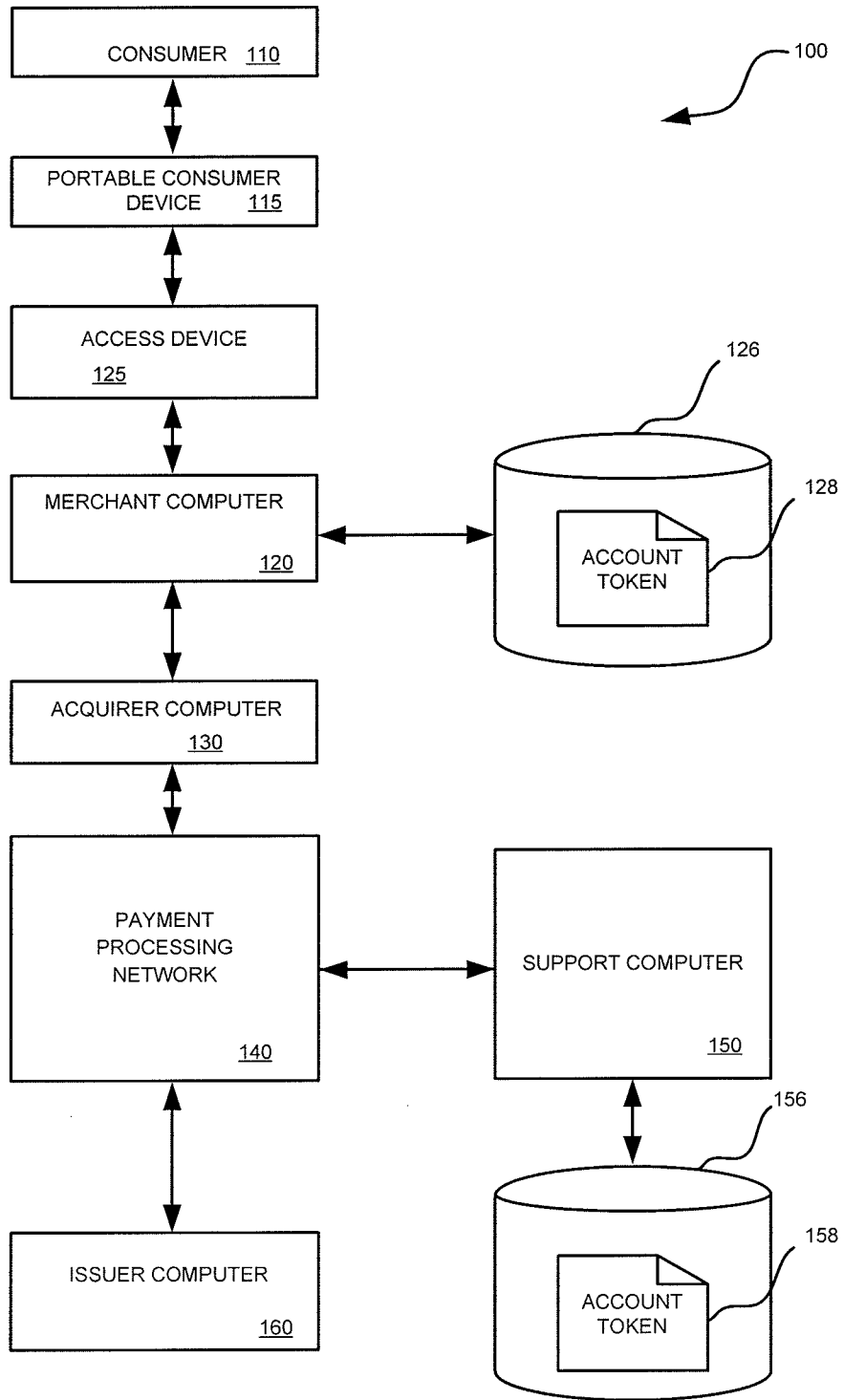

FIG. 1

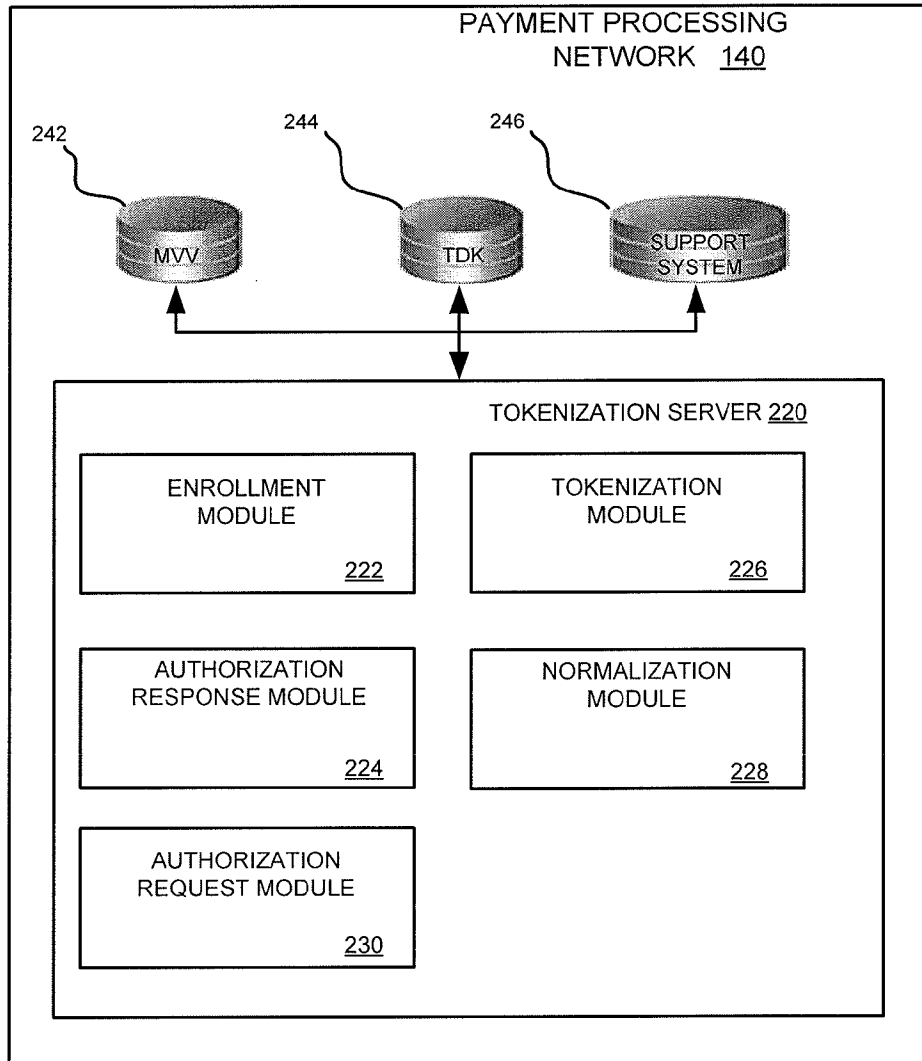

FIG. 2

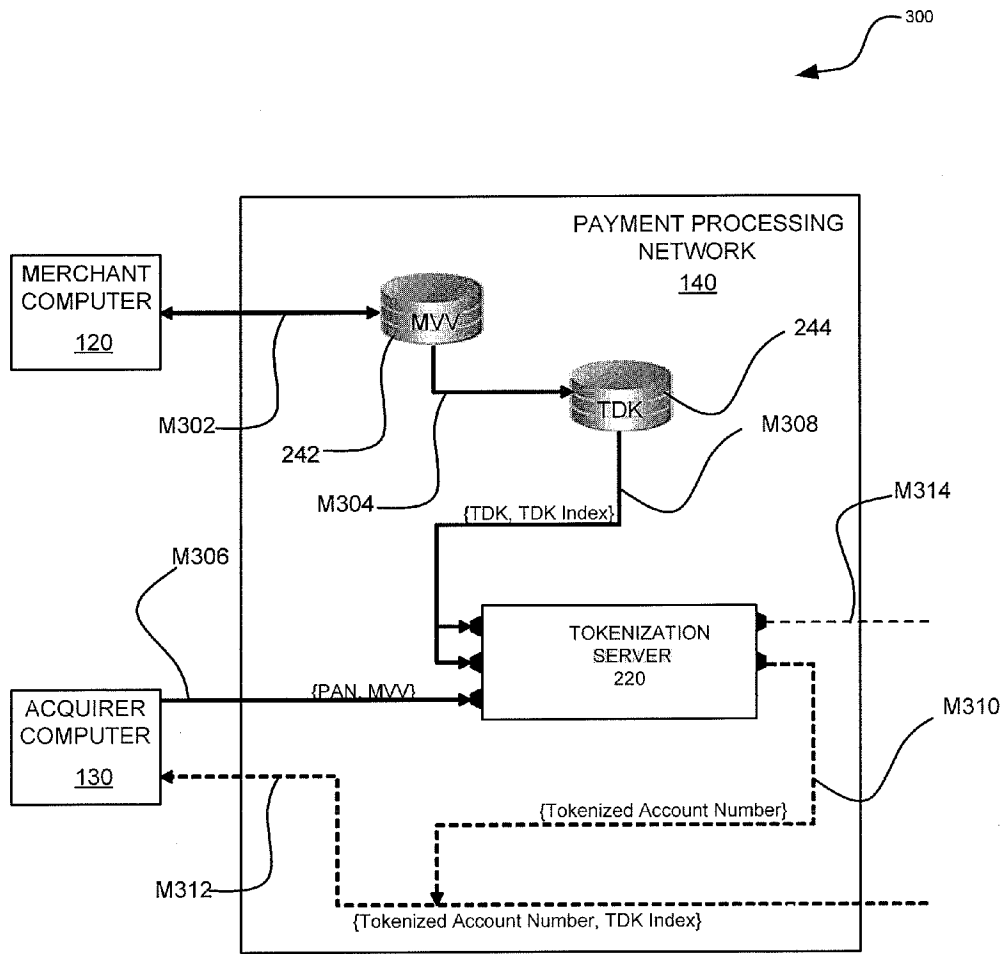

FIG. 3

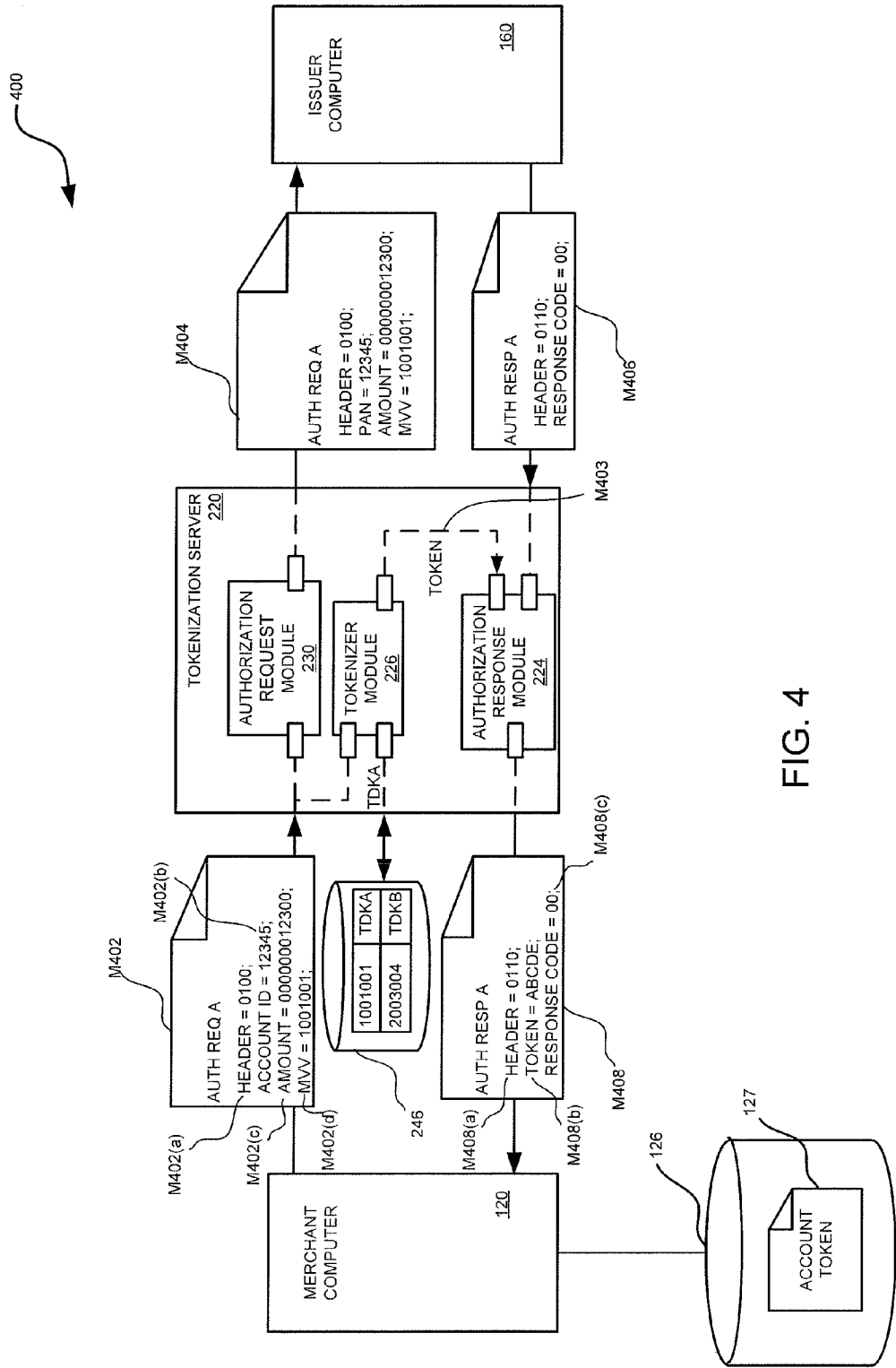

FIG. 4

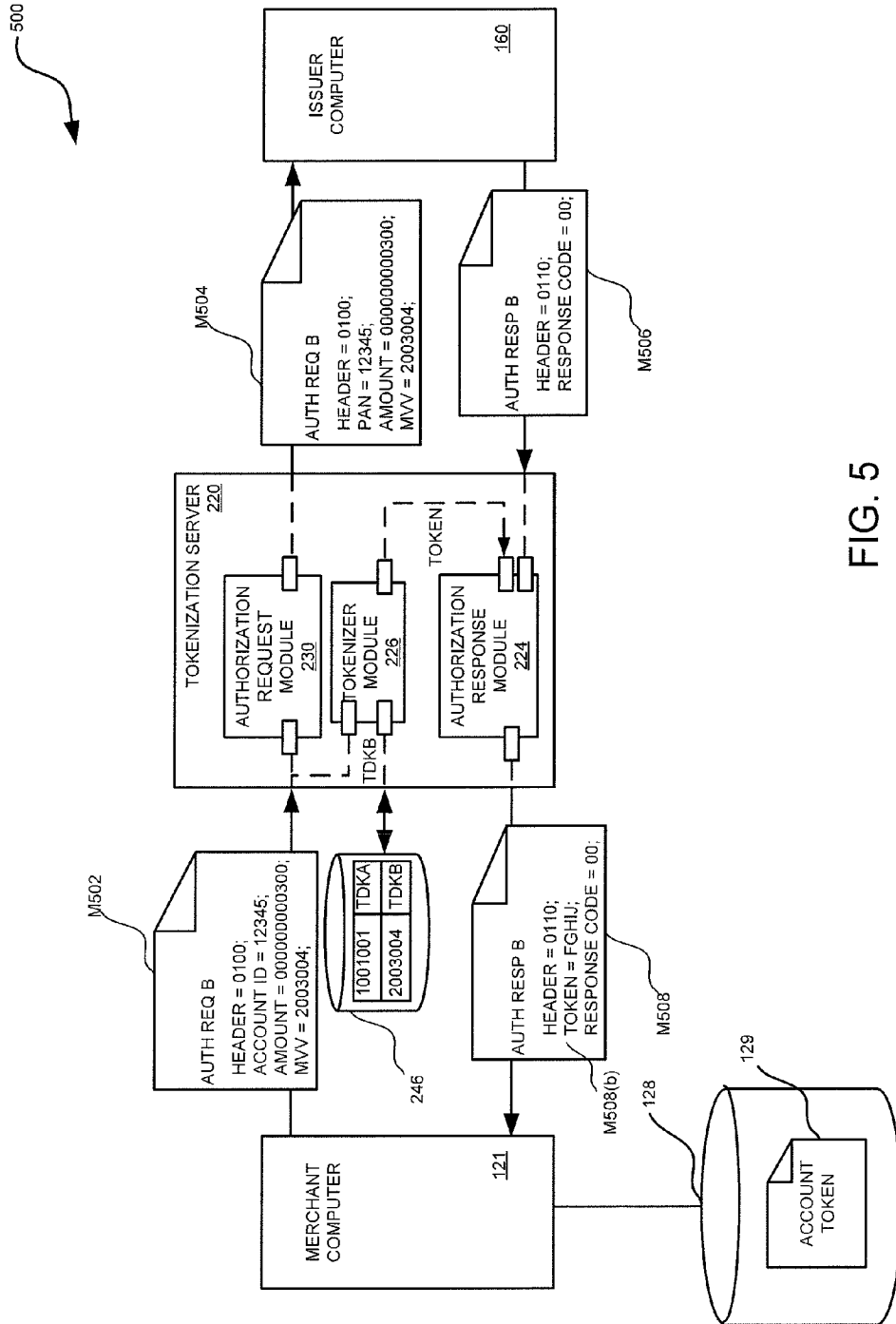
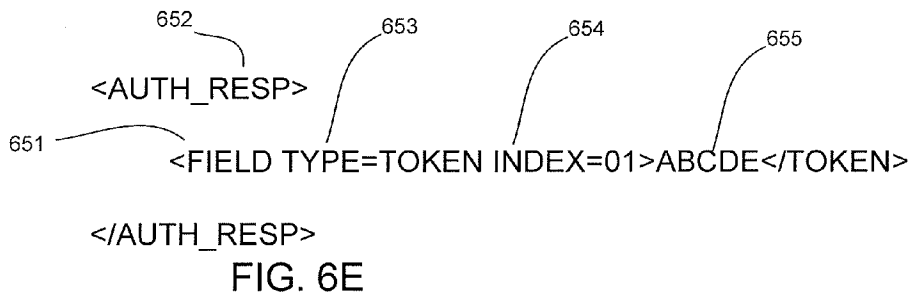
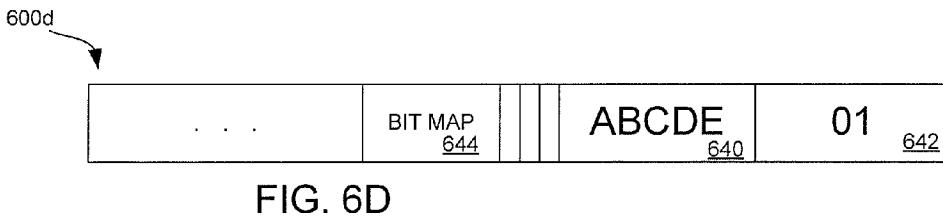
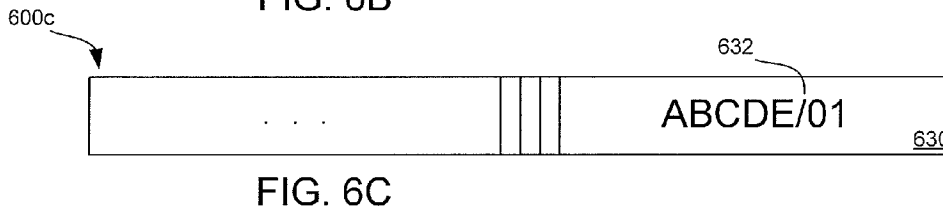
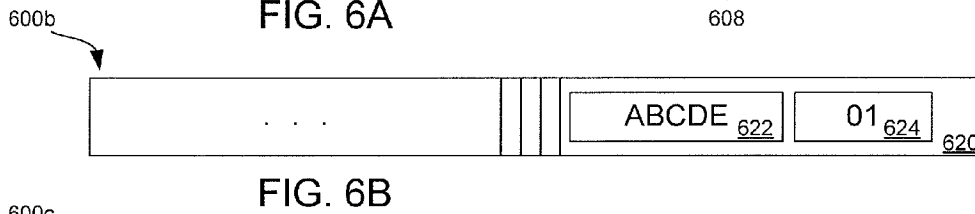
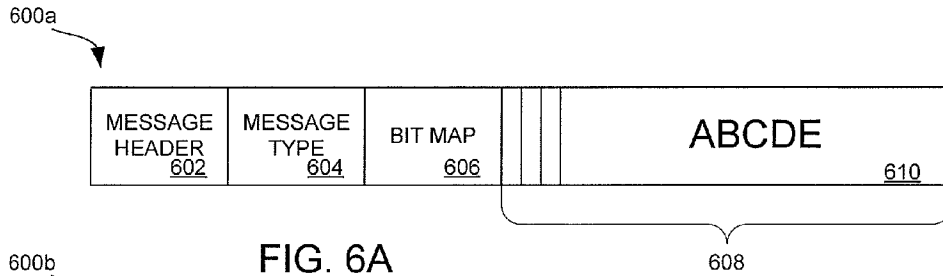

FIG. 5



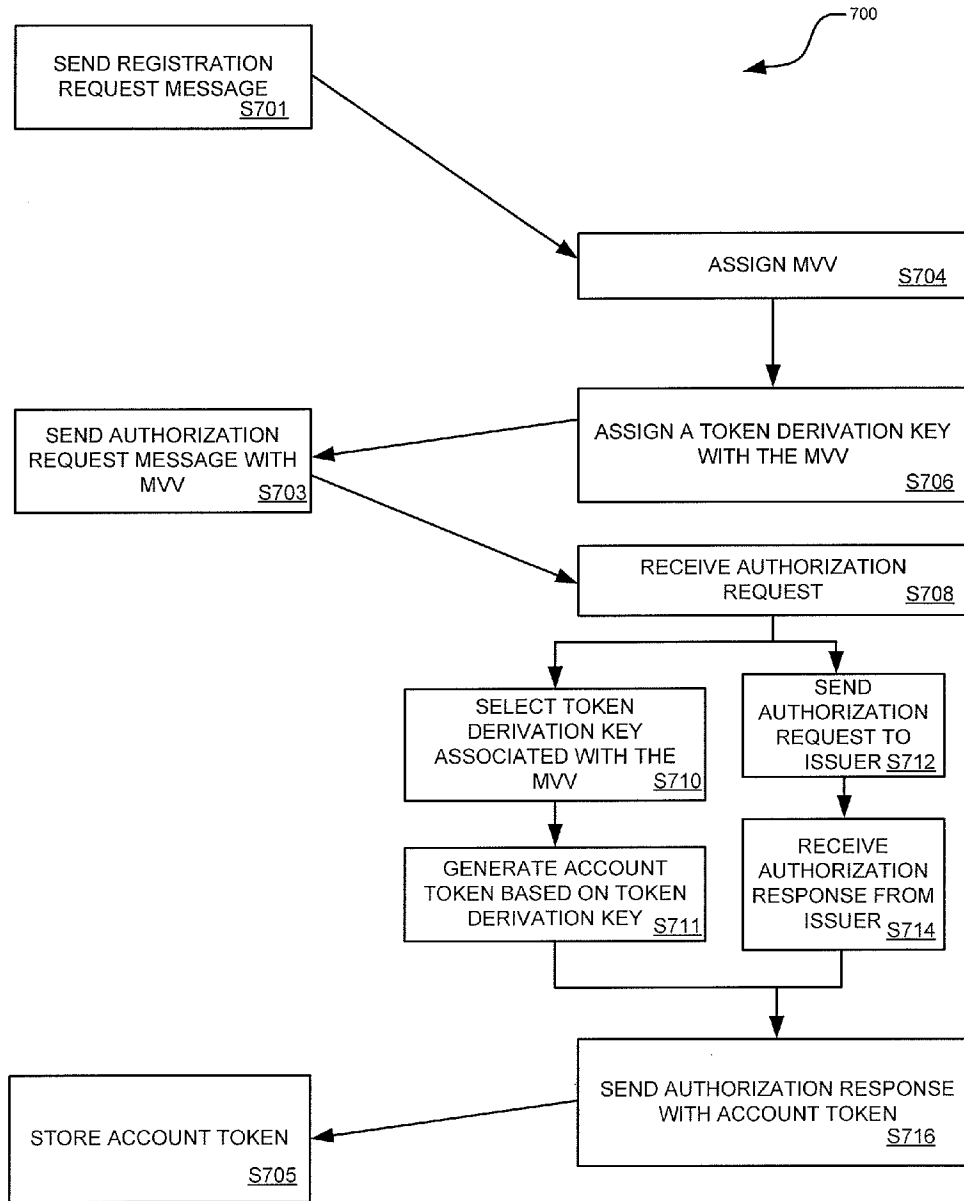

FIG. 7

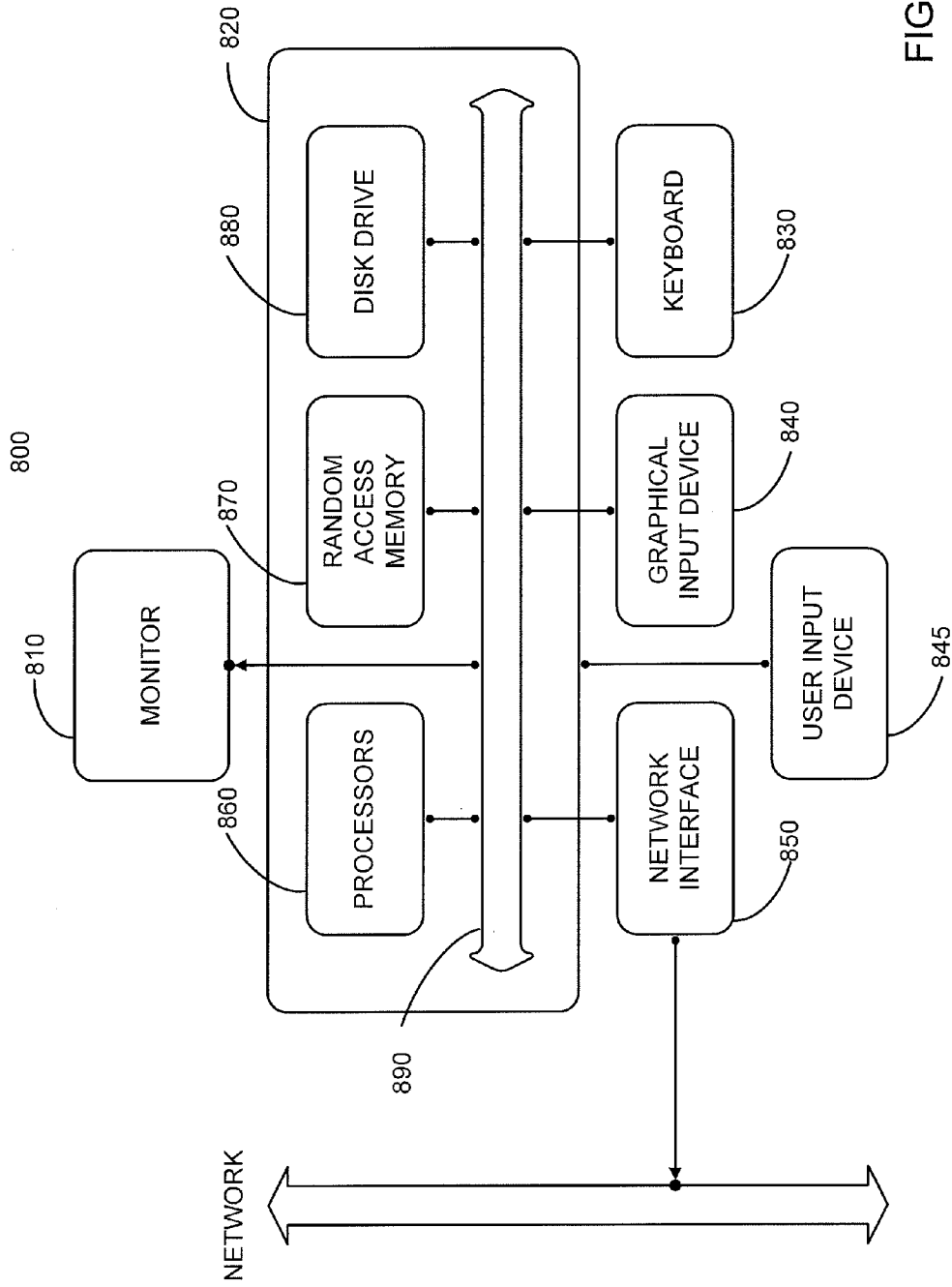

FIG. 8



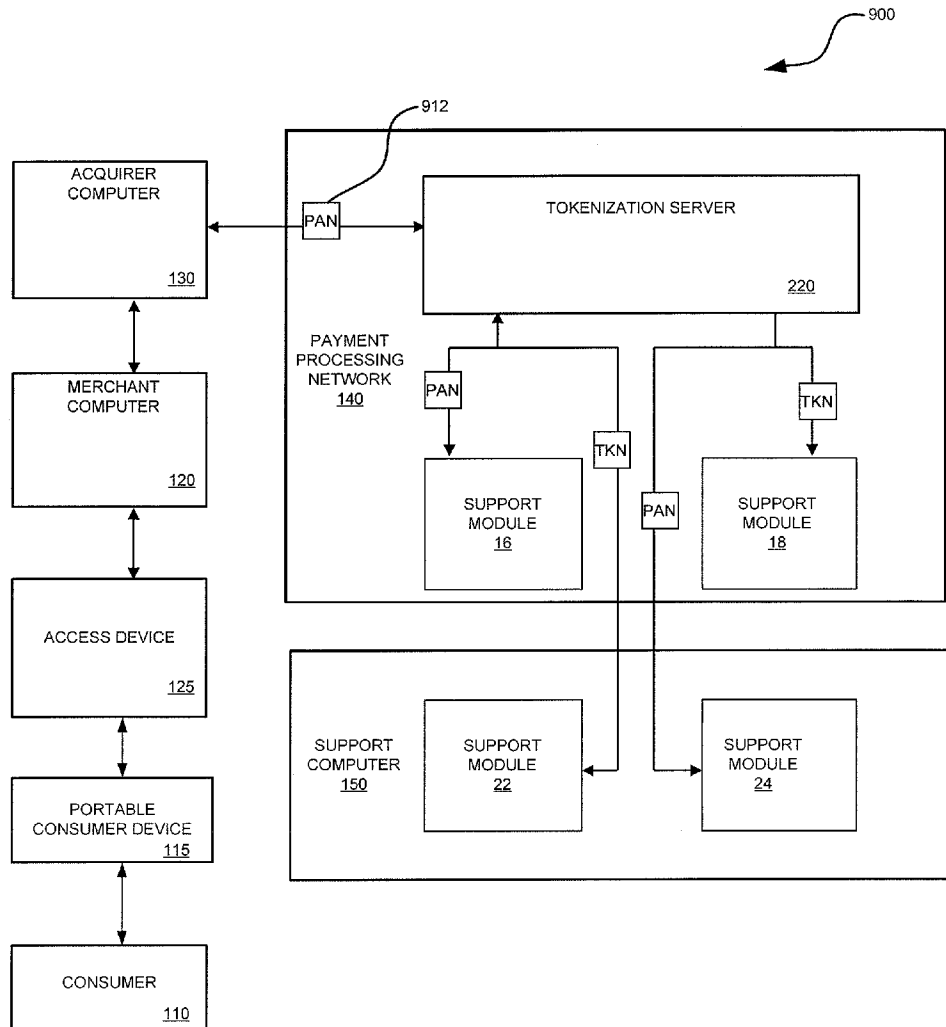

FIG. 9

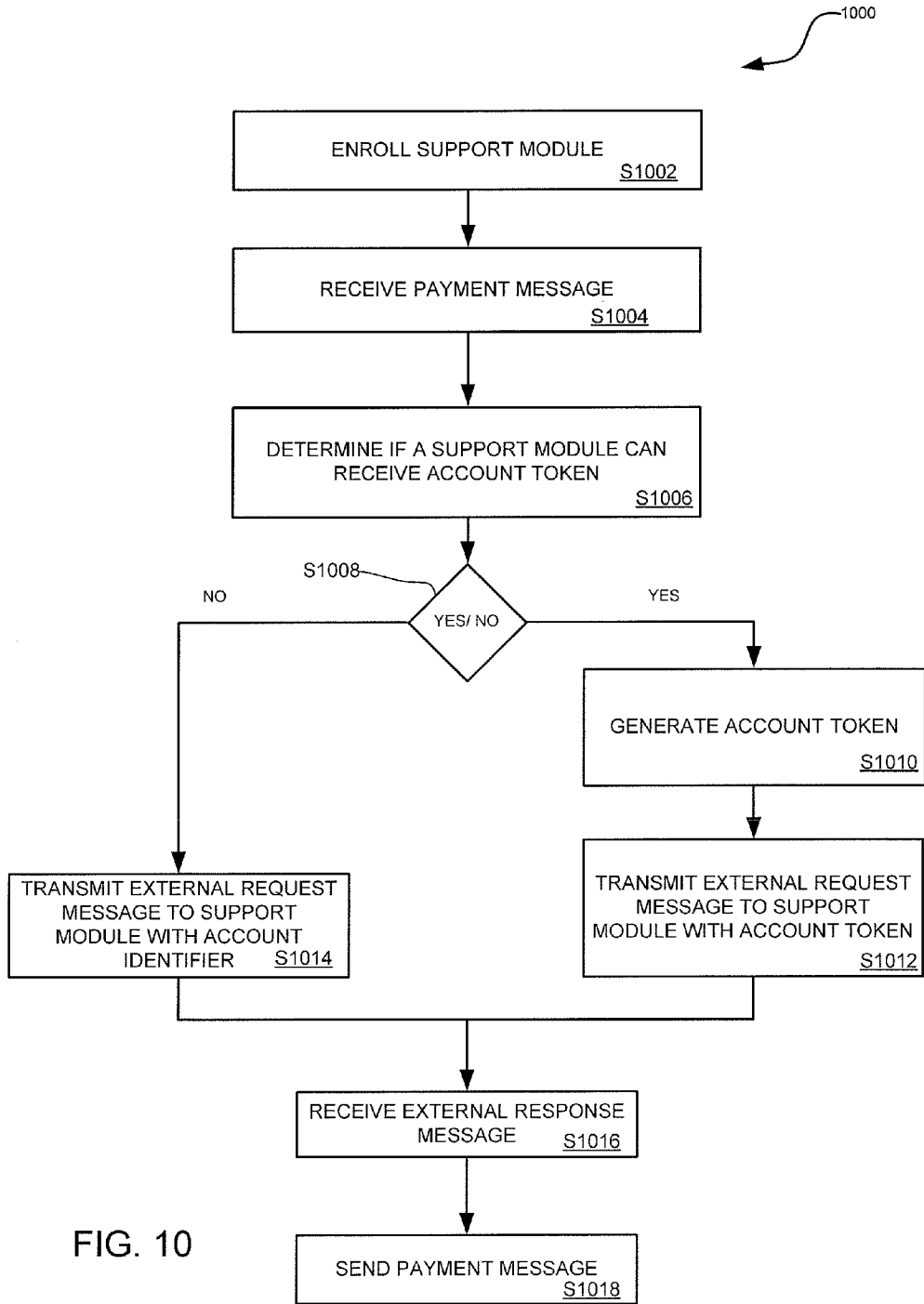

FIG. 10

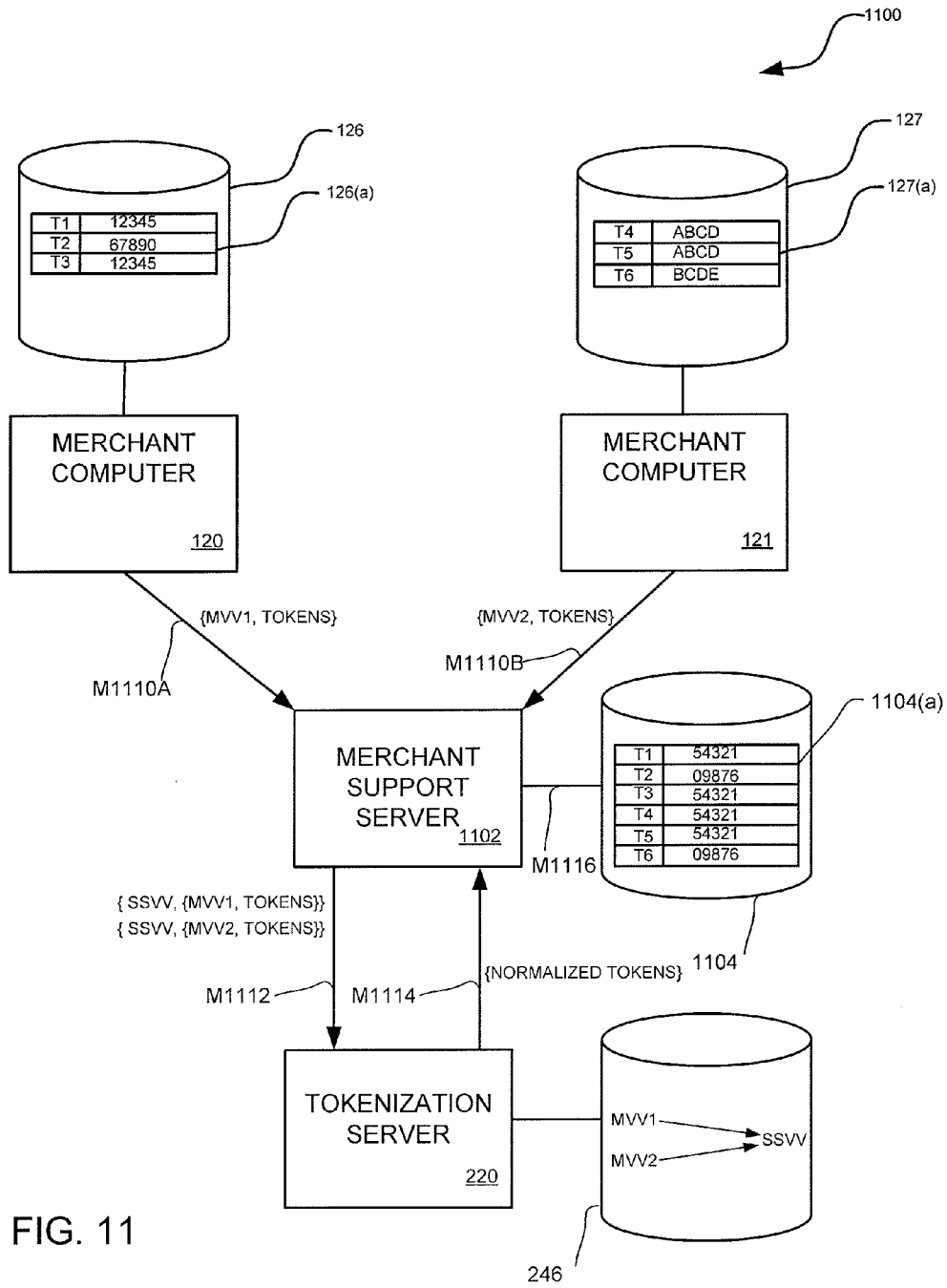

FIG. 11

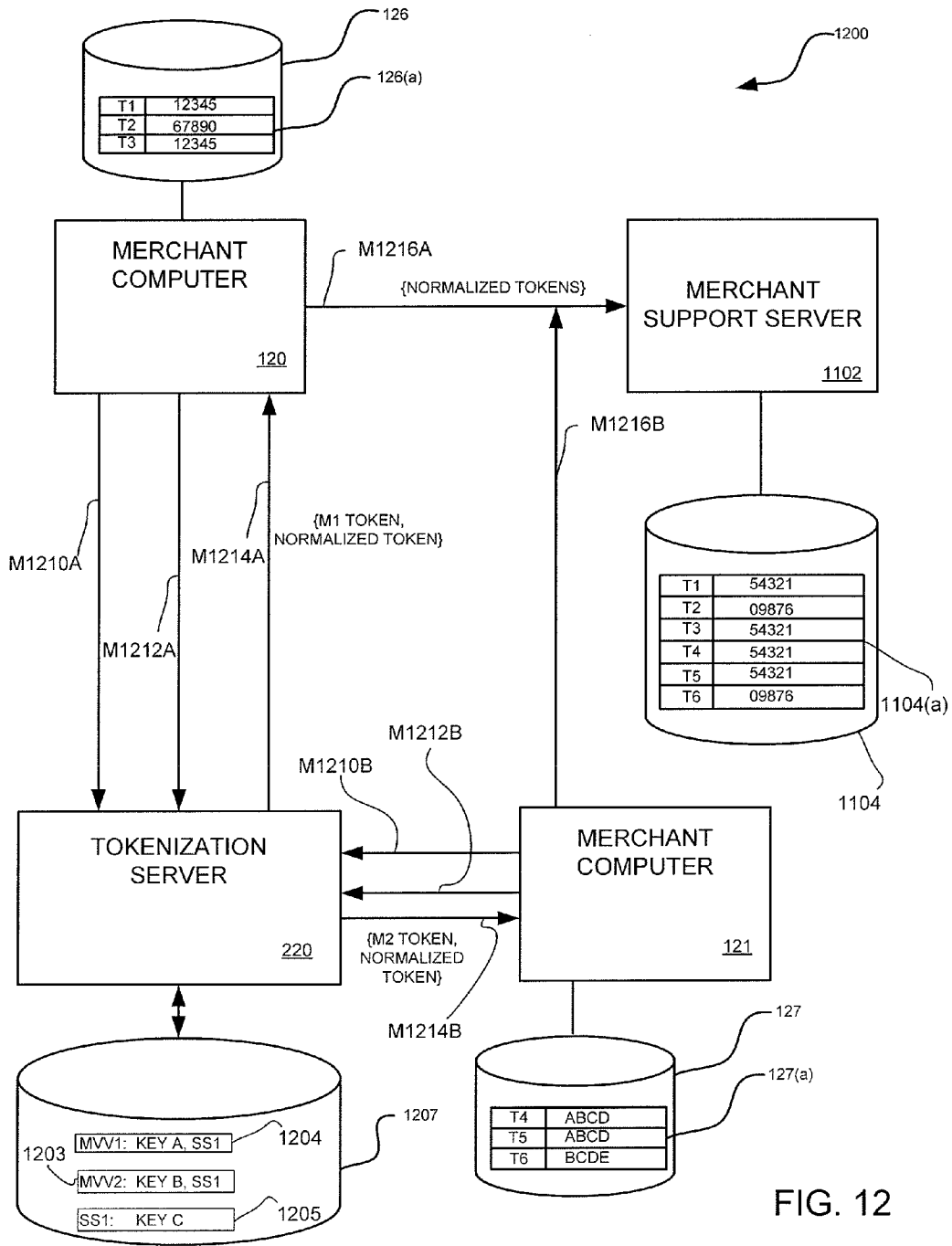

FIG. 12

1

## SECURING EXTERNAL SYSTEMS WITH ACCOUNT TOKEN SUBSTITUTION

### CROSS-REFERENCES TO RELATED APPLICATIONS

This application claims the benefit of U.S. Provisional Application No. 61/373,163, filed Aug. 12, 2010, entitled "SECURING SECONDARY SYSTEMS WITH TOKEN PAN SUBSTITUTION," and U.S. Provisional Application No. 61/381,322, filed Sep. 9, 2010, entitled "ACCOUNT NUMBER TOKENIZATION," which are herein incorporated by reference in their entirety for all purposes.

### BACKGROUND

As methods and devices for engaging in financial transactions have increased, old problems of protecting sensitive information persist. For example, one common source of fraud occurs when a hacker gains access to a data center and obtains sensitive information such as credit card numbers and other cardholder data. As another example, an employee entrusted to maintain sensitive information can provide a fraudster access to the cardholder data, either by voluntary act, trick, negligence, or accident.

To protect sensitive information from such fraud, a data center may encrypt the data it stores. For example, a merchant may wish to track financial transactions at one or more stores to gain insight on the purchasing tendencies of its customers. In this example, the merchant may store financial information (e.g., credit card numbers) associated with the purchases. However, because such information is sensitive and could be used to conduct fraudulent transactions, the merchant may secure the credit card numbers it collects by encrypting the credit numbers it stores in its data center.

A merchant processor that performs payment gateway services on behalf of a merchant is another example of a data center. For example, the merchant processor (as provided by CYBERSOURCE™, of Mountain View, Calif.), may receive payment information from a merchant computer, process the payment information into the format of an authorization request message, send the authorization request message to the appropriate payment processing network (as may be offered by VISA™), receive an authorization response message, and route the authorization response message back to the merchant computer so that the merchant can provide a good or service to a customer.

Other examples of data centers include acquirers and acquirer processors. An acquirer is typically a business entity (e.g., a commercial bank) that has a business relationship with a particular merchant. Acquirers may facilitate and manage financial transactions on behalf of merchants. An acquirer processor is typically a transaction processing entity that has a business relationship with a particular acquirer. Acquirer processors may provide merchants with transaction clearing, settlement, billing and reporting services.

In addition to the payment services described above, the acquirer or acquirer processor can also provide a variety of financial reports to the merchants registered for its services. For example, once a transaction has completed, the merchant may request information specifically for that transaction by sending a report request message to the acquirer or acquirer processor. The acquirer or acquirer processor may respond to the report request message by sending full payment information related to the specified transaction to the merchant.

To provide full payment information back to the merchant as part of these financial reports, the acquirer or acquirer

2

processor may store the credit card numbers involved in the transactions. Accordingly, the acquirer or acquirer processor can be a form of a data center that stores cardholder information and other sensitive information. For the reasons described above, the acquirer or acquirer processor may protect the cardholder information against potential fraudsters. In one approach, the acquirer or acquirer processor may encrypt the credit card numbers that it receives. Further, to avoid collisions between the credit card numbers, the acquirer or acquirer processor may use an encryption key specific to each merchant when the acquirer or acquirer processor encrypts an account number, for example.

When a data center (e.g., a merchant processor, merchant, acquirer processor, or acquirer) maintains a database of sensitive information, the data center may have to comply with a number regulations. Such regulations attempt to increase controls around cardholder data to reduce credit card fraud via its exposure. For example, the Payment Card Industry Data Security Standard (PCI DSS) is an information security standard for organizations that handle cardholder information for the major debit, credit, prepaid, e-purse, ATM, and POS cards. As part of the PCI DSS, a data center that stores and/or processes cardholder information must ensure that the cardholder data is secured. Further, the data center must perform periodic compliance testing.

As described above, a data center may encrypt cardholder information to comply with the PCI DSS. There are many known methods of encryption. Comparatively secure encryption systems are typically expensive and may consume large portions of a computer system's processing bandwidth.

Embodiments of the invention address the above problems, and other problems, individually and collectively.

### SUMMARY

Embodiments of the present invention can be directed to systems, apparatuses, and methods for providing account tokens to external systems during the lifecycle of a payment transaction. As is explained below, an account token is a sensitive form of an account identifier. Such account tokens can be sent to external entities, such as a merchant or a support computer, during the lifecycle of a transaction.

Some embodiments are directed to a method for providing an account token to a merchant computer. The method may involve a tokenization server receiving an authorization request message sent by a merchant computer. The authorization request message may request authorization for payment of a good or service and may include an account identifier and a merchant verification value. A token derivation key is then selected using the merchant verification value. The tokenization server then uses the token derivation key to generate the account token of the account identifier. The account token is inserted in an authorization response message that is then sent to the merchant computer.

Some embodiments are directed to a server that provides an account token to a merchant computer. The server receives an authorization request message sent by a merchant computer. The authorization request message includes an account identifier and a merchant verification value. The server then selects a token derivation key using the merchant verification value. The server then uses the token derivation key to generate the account token of the account identifier. The account token is inserted in an authorization response message that is then sent to the merchant computer.

Some embodiments are directed to a computer readable medium for performing a method of providing an account token to a merchant computer. The method may involve a

3

tokenization server receiving an authorization request message sent by a merchant computer. The authorization request message includes an account identifier and a merchant verification value. A token derivation key is then selected using the merchant verification value. The tokenization server then uses the token derivation key to generate the account token of the account identifier. The account token is inserted in an authorization response message that is then sent to the merchant computer.

Some embodiments are directed to a method for providing an account token to an external entity. The method may involve receiving a payment message that is associated with an account identifier. Then a tokenization server generates an account token of the account identifier associated with the payment message. An external request message with the account token is then transmitted to an external entity. An example of an external entity is a support computer that provides a risk score for a transaction. An external response message is then received. An example of an external response message is a risk score that corresponds to the payment message. After the external response message is received, the account identifier is then determined from the account token.

Some embodiments are directed to a server that provides an account token to an external entity. The server may receive a payment message that is associated with an account identifier. The server then generates an account token of the account identifier associated with the payment message. An external request message with the account token is then transmitted by the server to an external entity. An example of an external entity is a support computer that provides a risk score for a transaction. An external response message is then received by the server. An example of an external response message is a risk score that corresponds to the payment message. After the external response message is received, the account identifier is then determined from the account token.

Some embodiments are directed to a computer readable medium that includes instructions that, when executed by a processor, performs a method for providing an account token to an external entity. The method may involve receiving a payment message that is associated with an account identifier. Then a tokenization server generates an account token of the account identifier associated with the payment message. An external request message with the account token is then transmitted to an external entity. An example of an external entity is a support computer that provides a risk score for a transaction. An external response message is then received. An example of an external response message is a risk score that corresponds to the payment message. After the external response message is received, the account identifier is then determined from the account token.

#### BRIEF DESCRIPTION OF THE DRAWINGS

FIG. 1 is a block diagram of a system that uses account tokens, according to example embodiments.

FIG. 2 is a block diagram of the components of a payment processing network, according to example embodiments.

FIG. 3 is a block diagram that shows the messages involved in sending an account token, according to example embodiments.

FIG. 4 is a block diagram that shows the messages involved in sending an account token to a first merchant, according to example embodiments.

FIG. 5 is a block diagram that shows the messages involved in sending an account token to a second merchant, according to example embodiments.

4

FIGS. 6A, 6B, 6C, 6D, and 6E are diagrams that show various formats of an authorization request message, according to example embodiments.

FIG. 7 is a flow diagram that shows a method for generating an account token, according to example embodiments.

FIG. 8 is a block diagram illustrating the primary functional components of a computer or computing system that may be used to implement an element or component used in some embodiments of the present invention.

FIG. 9 is a block diagram showing account tokens sent to a support computer, according to example embodiments.

FIG. 10 is a flow diagram showing steps for sending an account token to a support computer, according to an example embodiment.

FIG. 11 is a block diagram showing a first technique for normalizing account tokens, according to example embodiments.

FIG. 12 is a block diagram showing a second technique for normalizing account tokens, according to example embodiments.

#### DETAILED DESCRIPTION

Embodiments of the invention relate to methods and systems for mitigating risks associated with transmitting and storing sensitive account identifiers. Particularly, example embodiments of the invention relate to generating an account token at a payment processing network as part of an authorization process involving a merchant computer, an acquirer computer, and/or a support computer.

However, prior to discussing the example embodiments of the invention, a further description of some terms can be provided for a better understanding of embodiments of the invention.

As used herein, an “account identifier” can refer to any information that identifies an account that holds value for a user. An account identifier can be represented as a sequence of characters or symbols. An account identifier is typically provided as part of a transaction, such as a payment transaction, that credits value to the account, debits value to the account, or performs any other suitable action on the account. Credit card numbers, checking and saving account numbers, prepaid account numbers, aliases and/or a passwords, phone numbers, and any other suitable identifier are all examples of account identifiers.

As used herein, an “account token” can refer to the result of transforming an account identifier into a form that is not considered sensitive in the context of the environment in which the account token resides. A “tokenization algorithm” can refer to the sequence of steps used to transform an account identifier into an account token. Still further, a “reverse tokenization algorithm” can refer to the sequence of steps used to transform the account token back to the account identifier. The tokenization algorithm may replace sensitive data, or portions thereof, with a value that is not considered sensitive.

As used herein, a “token derivation key” can refer to any piece of information that is used as a parameter of a tokenization algorithm. The token derivation key can be used to vary the output of a tokenization algorithm. In some embodiments, a token derivation key is symmetric as the same token derivation key is used for both tokenization and reverse tokenization. In other embodiments, a token derivation key is asymmetric as the token derivation key used to tokenize an account identifier is not used in the reverse tokenization algorithm. Instead, a second token derivation key is used in the reverse tokenization.

An “authorization request message” can refer to a message, or sequence of messages, that requests an issuer of the payment card to authorize a transaction. An authorization request message according to an embodiment of the invention may comply with ISO (International Organization for Standardization) 8583, which is a standard for systems that exchange electronic transactions made by cardholders using payment cards. An authorization request message according to other embodiments may comply with other suitable standards.

An “authorization response message” can refer to a message, or sequence of messages, that responds to a merchant’s and/or acquirer’s request to authorize a transaction. An authorization response message according to an embodiment of the invention may comply with ISO 8583, which, as described above, is a standard for systems that exchange electronic transactions made by cardholders using payment cards. An authorization response message according to other embodiments may comply with other suitable standards.

A “merchant verification value” may refer to any information that identifies a merchant as a participant in a service or program. As an example, a merchant verification value may be assigned to a business, person, or organization that has agreed to accept payment cards when properly presented by the cardholder. A merchant verification value can be any combination of characters and/or symbols. Further, a merchant verification value can be transmitted to a payment processing network as part of an authorization request message.

A “support system verification value” may refer to any information that identifies a support system as a provider of a service or program. As an example, a support system verification value may be assigned to a web service that provides a fraud score for a transaction. As another example, a support system verification value can be assigned to an alert web service that sends a message to a consumer’s communication device (e.g., mobile phone) when one or more conditions applied. Such a message can be for a coupon or an alert that a transaction or activity has occurred with regard to a particular account. A support system verification value can be any combination of characters and/or symbols. Further, in some embodiments, a support system verification value can be transmitted to a payment processing network as part of an authorization request message.

A “verification value,” as used herein, can refer to a merchant verification value, a support system verification value, or some combination thereof.

Generally, embodiments relate to apparatuses, systems, and methods of securing sensitive data. In particular, some embodiments improve security of a data center that stores, for example, account identifiers by communicating account tokens from a tokenization server to external entities (e.g., merchant computers or a support computers). Further, in some embodiments, the account tokens communicated to the external entity is generated specific for the external entity. For example, when a merchant is enrolled with a tokenization service, the merchant is assigned a merchant verification value and token derivation key. Thereafter, subsequent communications between a merchant computer and a tokenization server may cause the tokenization server to generate an account token specific to the merchant by using the assigned token derivation key.

To illustrate, when a consumer swipes a credit card at a merchant’s store to purchase an item, a bank associated with the merchant may send an authorization request message with a particular account identifier and the merchant verification value assigned to the merchant to the payment processing network. In generating an authorization response message, a tokenization server associated with the payment processing

network may select the token derivation key assigned to the merchant (as may be determined by matching a merchant verification value included in the authorization request message to a previously assigned token derivation key) and then generate an account token of the account identifier using the token derivation key. The account token is then inserted in the authorization response message, which is then sent back to the merchant via the bank.

A similar technique can be used to communicate account tokens to support systems, as is further described below.

By communicating an account token to the merchant, example embodiments can provide comparatively secure communication and comparatively secure storage for sensitive information, such as the cardholder data (e.g., credit card number) and other financial information. For example, if a fraudster hacks into the merchant’s systems, the account tokens of the account identifiers stored by the merchant will not be useful to the fraudster because the account tokens can not be used alone to conduct financial transactions. That is, the fraudster will be unable to use the account tokens to perform financial transactions.

In some embodiments, a merchant and/or support system does not have access to the reverse token derivation keys needed to transform the account tokens to the corresponding account identifiers. Instead, a tokenization server stores the reverse token derivation keys. Therefore, the risk of compromised cardholder data is further limited in that a fraudster may have to breach the merchant and/or support system to obtain the account tokens and may also have to breach the tokenization server to obtain the reverse token derivation keys. Furthermore, even if the account tokens are compromised for a particular merchant and/or support system (e.g., if the fraudster obtains both the account tokens and reverse token derivation keys), the account tokens for other merchants and/or support systems may remain inaccessible to the fraudster.

Still further, because an account token is received in the authorization response message in addition to or in lieu of the actual account identifier, the apparatuses, methods, and systems described herein also reduce merchant post-processing efforts needed to support encryption or hashing of the account numbers after the authorization response message is received.

As a further advantage, the merchant can use the tokenized account identifier to conduct customer analytics in lieu of the original card identifier. Once the card account numbers are removed from the merchant’s systems (often during or after the daily batch sales draft clearing process), the merchant can retain the tokenized account identifier for future analytics and customer tracking, while simultaneously complying with security standards (such as Payment Card Industry Data Security Standard (PCI DSS)) and reducing risk of damaging data breaches. For example, in order to maximize sales, merchants often have the need to perform customer activity tracking and segmentation/spend analyses using sales history. However, using the account identifier to identify customers requires long-term storage of cardholder account identifiers, potentially leading to increased data breach risk and security standards non-compliance. Embodiments of the invention provide a method to tokenize the account identifier so that it can be used in lieu of the actual account identifier to perform merchant customer analytics.

In another example, embodiments of the invention may facilitate customer analytics that allow merchants to measure velocity of purchases (e.g., if five transactions occur within a relatively short time period over a disperse geographic area). Based on an application observing the account tokens, the merchant may deny selected transactions if the merchant

detects a suspicious velocity pattern, even if the transaction is authorized by the payment processing network.

In another example, embodiments of the invention may facilitate customer analytics that allow merchants to measure the velocity of purchases to provide various customer loyalty services. For example, based on an application observing the account tokens, the merchant may provide a benefit to repeat customers (e.g., if a customer purchases the same product on five occasions, the merchant can provide the customer with an additional product at no cost).

#### I. Exemplary Payment System

Example embodiments are typically implemented in the context of a payment transaction. Therefore, prior to further discussing the use of a tokenization server configured to provide account tokens, a brief description of standard consumer purchases will be presented.

An exemplary system **100** for embodiments of the invention can be seen in FIG. 1. For simplicity of discussion, only one of each component is shown. It is understood, however, that embodiments of the invention may include more than one of each component. In addition, some embodiments of the invention may include fewer than all of the components shown in FIG. 1. Also, the components in FIG. 1 may communicate via any suitable communication medium (including the internet), using any suitable communication protocol.

FIG. 1 shows a system **100** that can be used in an embodiment of the invention. The system **100** includes a merchant computer **120** and an acquirer computer **130** communicatively coupled to the merchant computer **120**. In a typical payment transaction, a consumer **110** may purchase goods or services at a merchant associated with the merchant computer **120** using a portable consumer device **115**. The acquirer computer **130** can communicate with an issuer computer **160** via a payment processing network **140**.

The consumer **110** may be an individual, or an organization such as a business that is capable of purchasing goods or services.

The portable consumer device **115** may be in any suitable form. For example, suitable portable consumer devices can be hand-held and compact so that they can fit into a consumer's wallet and/or pocket (e.g., pocket-sized). The portable consumer device **115** can include a processor, and memory, input devices, and output devices, operatively coupled to the processor. Specific examples of portable consumer devices include cellular or wireless phones, personal digital assistants (PDAs), pagers, portable computers, smart cards, and the like. The portable consumer devices can also be debit devices (e.g., a debit card), credit devices (e.g., a credit card), or stored value devices (e.g., a pre-paid or stored value card).

The payment processing network **140** may include data processing subsystems, networks, and operations used to support and deliver authorization services, exception file services, and clearing and settlement services. An exemplary payment processing network may include VisaNet™. Payment processing networks such as VisaNet™ are able to process credit card transactions, debit card transactions, and other types of commercial transactions. VisaNet™, in particular, includes a VIP system (Visa Integrated Payments system) which processes authorization request messages and in some instances also performs clearing services, and a Base II system which performs clearing services in instances when it is not performed by the VIP system.

The payment processing network **140** may include a server computer. A server computer is typically a powerful computer or cluster of computers. For example, the server computer can be a large mainframe, a minicomputer cluster, or a group of servers functioning as a unit. In one example, the

server computer may be a database server coupled to a Web server. The payment processing network **140** may use any suitable wired or wireless network, including the Internet.

The merchant computer **120** may also have, or may receive communications from, an access device **125** that can interact with the portable consumer device **115**. The access devices **125** according to embodiments of the invention can be in any suitable form. Examples of access devices include point of sale (POS) devices, cellular phones, PDAs, personal computers (PCs), tablet PCs, handheld specialized readers, set-top boxes, electronic cash registers, automated teller machines (ATMs), virtual cash registers, kiosks, security systems, access systems, and the like.

If the access device **125** is a point of sale terminal, any suitable point of sale terminal may be used including card or phone readers. The card or phone readers may include any suitable contact or contactless mode of operation. For example, exemplary readers can include RF (radio frequency) antennas, magnetic stripe readers, etc. to interact with the portable consumer devices **115**.

In a typical purchase transaction, the consumer **110** purchases a good or service at the merchant associated with the merchant computer **120** using the portable consumer device **115** such as a credit card or mobile phone. The consumer's portable consumer device **115** can interact with an access device **125** such as a POS (point of sale) terminal communicatively coupled to the merchant computer **120**. For example, the consumer **110** may swipe the credit card through a POS terminal or, in another embodiment, may take a wireless phone and may pass it near a contactless reader in a POS terminal.

An authorization request message may then be forwarded by the merchant computer **120** to the acquirer computer **130**. After receiving the authorization request message, the authorization request message may then be sent to the payment processing network **140**. The payment processing network **140** may then forward the authorization request message to the issuer computer **160** associated with the portable consumer device **115**.

As shown in FIG. 1, the payment processing network **140** can be communicatively coupled to a support computer **150**. The support computer **150** can perform functions that support or supplement the authorization process. Fraud scoring system, alert systems, reporting systems, etc are examples of support computers, according to various embodiments.

After the issuer computer **160** receives the authorization request message, the issuer computer **160** may send an authorization response message back to the payment processing network **140** to indicate whether or not the current transaction is authorized (or not authorized). The transaction processing system **140** may then forward the authorization response message back to the acquirer computer **130**. The acquirer computer **130** may then send the response message back to the merchant computer **120**.

After the merchant computer **120** receives the authorization response message, the access device **125** communicatively connected to the merchant computer **120** may then provide the authorization response message for the consumer **110**. The authorization response message may be displayed by the POS terminal, or may be printed out on a receipt.

During the lifecycle of a transaction, the payment processing network **140** may generate account tokens of the account identifiers sent in the authorization request message. In some embodiments, an account token **128** can be generated and sent to the merchant computer **120** and/or the acquirer computer **130**. The merchant computer **120** and/or acquirer computer **130** can store the account token **128** in account token



database **126**. In other embodiments, an account token **158** can be generated and sent to a support computer **150**. The support computer **150** can store the account token **158** in account token database **156**.

At the end of the day, a normal clearing and settlement process can be conducted by the payment processing network **140**. A clearing process is a process of exchanging financial details between an acquirer and an issuer to facilitate posting to a consumer's account and reconciliation of the consumer's settlement position. During the clearing process, the acquirer computer **130** can send the account token **128** to the payment processing network **140**. The payment processing network **140** may then use the reverse token derivation key for the particular merchant to retrieve the corresponding account identifier. The payment processing network **140** can send the account identifier to the issuer computer **160** to perform clearing and settlement. In some embodiments, clearing and settlement can occur simultaneously.

Once clearing and settlement are performed, the merchant computer **120** may remove the account identifiers stored in their systems. In other embodiments of the invention, as described herein, the merchant computer **120** can receive account tokens in lieu of account identifiers, thus eliminating the need to remove account identifiers stored in the merchant's systems. As an advantage of embodiments of the invention, the merchant computer **120** may retain the account tokens, thereby allowing customer analytics, as described above.

## II. Tokenization Server

FIG. 2 is a block diagram that shows components of the payment processing network **140**, according to embodiments of the invention. As shown, the payment processing network **140** includes a tokenization server **220**. The tokenization server **220** may be embodied by one or more computational apparatuses, which can perform the methods and process described herein. Typically, the tokenization server **220** is a computer or cluster of computers that behave as a single computer. For example, the tokenization server **220** can be a mainframe computer, a personal computer, a microprocessor, or some combination thereof. In another example, the tokenization server **220** may include one or more database servers and one or more Web servers. The tokenization server **220** may service the requests of one or more client computers.

The tokenization server **220** may include an enrollment module **222**, an authorization response module **224**, a tokenization module **226**, a normalization module **228**, and an authorization request module **230**.

The enrollment module **222** may receive requests for enrolling external entities, such as merchants and support systems, in the tokenization service provided by the payment processing network **140**. In some embodiments, the enrollment module **222** may assign an identifier to an external entity that is successfully enrolled in the tokenization service. For example, a merchant may be assigned a merchant verification value which is sent in subsequent authorization request messages sent to the payment processing network. The merchant verification values assigned to merchants can be stored in MVV database **242**. Alternatively, a support system may be assigned a support system verification value that uniquely identifies the support system. The support system verification values assigned to support systems can be stored in support system database **246**.

The authorization response module **224** performs a number of functions related to inserting account tokens into messages communicated between the payment processing network **140** and merchants, issuers, and acquirers. For example, according to one embodiment, the payment processing network **140**

receives an authorization response messages from an issuer, processes the received authorization response message, and sends the processed authorization response message to the appropriate merchant and/or acquirer. Inserting an account token into the authorization response message by the authorization response module **224** is an example of one type of processing the payment processing network **140** performs. The authorization response module **224** can receive account tokens from the tokenization module **226**.

The tokenization module **226** may generate the account tokens that are used in the embodiments described herein. In one embodiment, the tokenization module **226** generates account tokens based on a merchant verification value received in an authorization request message. For example, the tokenization module **226** may use the merchant verification value as an index into a token derivation key database (as is discussed below) to obtain a token derivation key assigned to the merchant. Once the token derivation key is obtained, the tokenization module **226** can then generate the account token by applying the account identifier to an encryption or hash function, with the merchant's token derivation key as a parameter. This and other techniques are described in greater detail below.

The normalization module **228** may provide facilities that allow the payment processing network **140** to transform an account token from a first account token form to a second account token form. Such may be an advantage for comparing the account tokens received by two or more merchants. This is because the account tokens generated by the tokenization module **226** are merchant specific. As explained below, the normalization module **228** may provide a scheme for generating an account token common to one or more merchants to provide for comprehensive analytics and services, as may be provided by merchant support systems.

The authorization request module **230** may perform a number of functions related to receiving and forwarding authorization request messages. As part of receiving an authorization request message, the authorization request module **230** may forward the authorization request message to the issuer computer **160** or to the support computer **150**. Alternatively, the payment processing network **140** can forward the authorization request message to the issuer computer **160** or to the support computer **150** without using the authorization request module **230**.

Further, the tokenization server **220** may have access to one or more databases of information. As shown in FIG. 2, the tokenization server **220** may have access to a MVV database **242**, a TDK database **244**, and a support system database **246**. The MVV database **242** can store merchant verification values that are assigned to merchants that enroll in the tokenization services. As discussed above, a merchant verification value is one example of a merchant identifier and other suitable identifiers can also be used in other embodiments of the invention.

The TDK database **244** may store the token derivation keys that are assigned to merchants enrolled in the tokenization services. As described above, a token derivation key can be in any number of suitable forms using, for example, symmetrical or asymmetrical key algorithms. Further, as described above, in some embodiments, the tokenization server **220** can update the token derivation key assigned to a merchant at various points in time. For example, the tokenization server **220** may update a merchant's token derivation key if a fraudster compromises the account token data stored at a merchant. To provide such dynamic updates, the TDK database **244** can associate a token derivation key index with the assigned token derivation key.

11

The support system database **246** may store information regarding the support systems communicatively coupled to the payment processing network. For example, each support system may be assigned a unique support system verification value at the time that the support system is deployed or, in some embodiments, the support system may perform an enrollment process. Additionally, the support system database **246** may store information on whether the support system is capable of receiving account tokens rather than the account identifiers. In this way, the process of connecting support systems to the payment processing network can be achieved dynamically. Such dynamic connections can be implemented according to various system architectures, such as a directory service, event based systems, or any other scalable architecture.

### III. Provisioning Account Tokens to External Parties

As described above, some embodiments of the present invention relate to a tokenization server that generates account tokens of account identifiers for merchants. Other embodiments of the present invention relate to a tokenization server that generates account tokens of account identifiers for support systems of a payment processing network. Further, there are still other embodiments where the tokenization server provides facilities for providing account tokens to a support system of one or more merchants. These various embodiments are described separately below. In particular, Section IV describes various embodiments for generating and sending account tokens to merchants, Section V describes various embodiments for generating and sending account tokens to support systems of the payment processing network, and Section VI describes various embodiments for generating and sending account tokens to merchant support systems.

### IV. Provisioning Account Tokens to Merchants

FIG. 3 is a block diagram that illustrates a simplified system **300** that provides account tokens to merchants. In particular, the system includes a first facility for registering a merchant and a second facility for sending an account token in an authorization response message that was generated in response to an authorization request message. The operation of the system **300** is described with reference to FIG. 7, which shows a flow diagram for a method **700** of sending an account token to a merchant.

#### A. Merchant Registration

In some embodiments, the merchant computer **120** may transmit a registration request message **M302** to the tokenization server **220**. This is shown as step **S701** of FIG. 7. The registration request message may include registration information, such as a merchant name, merchant category type, merchant location, contact information, account information, and any other suitable information. The registration information may be transmitted via offline communication channels (e.g., via a telephone) or online communication channels (via software interfaces communicating over the network, for example).

Responsive to receiving the registration request message **M302**, the payment processing network **140** may assign the merchant a merchant verification value (MVV), if a MVV is not already assigned. With respect to FIG. 7, this is shown as step **S704**. The MVV may be used by the payment processing network **140** to identify the merchant and information corresponding to the merchant. The MVV can be generated and maintained by the payment processing network **140** in MVV database **242** to identify the merchant. The payment processing network **140** may communicate the assigned MVV to the merchant.

12

In addition to assigning the MVV, the payment processing network **140** may generate a token derivation key (TDK) corresponding to the merchant and/or the MVV (message **M304**). With regard to FIG. 7, this is shown as step **S706**. As described above, and further explained below, the TDK may be a piece of information used by the tokenization module **226** to generate an account token. The payment processing network **140** may assign a unique TDK for each merchant registered in the tokenization service. In an example embodiment, the payment processing network **140** may store and maintains the TDK in database **244**.

By assigning the TDK to the MVV, the payment processing network **140** provides an additional layer of security to the tokenization algorithm. To illustrate, in the event that a fraudster is able obtain the TDK assigned to merchant **120**, the account token databases maintained by other merchants will be secure. Such is the case because the TDK of one merchant can not be used to reverse tokenize the account tokens generated for other merchants.

In addition to generating the TDK, some example embodiments may generate a TDK index associated with the TDK. The TDK index may allow identification of a particular TDK for those embodiments that may generate multiple or subsequent TDKs for a given MVV. The TDK index and supporting multiple TDKs per merchant are described further below.

A merchant may only need to register once, and after completion of the registration process, subsequent communications with the merchant and or the acquirer of the merchant may include the account token rather than the less secure account identifier, as will be further described below.

#### B. Authorization

Once a merchant is registered in the tokenization service, a payment processing network may transmit an account token in communications exchanged with the merchant and/or acquirer. One situation that the payment processing network may transmit the account token to the merchant and/or acquirer is in the authorization process, for example, when a consumer's credit card is swiped at a POS terminal located at the merchant site. When the consumer's credit card is swiped, the acquirer computer **130** may transmit an authorization request message **M306** to the payment processing network **140**. This is shown as step **S703** of FIG. 7. The authorization request message may be in the form of a typical authorization request message, wherein the authorization request message may include the account identifier and the MVV assigned to the merchant (e.g., as may be stored in fields 2 and 62.20 of an ISO 8583 message, respectively).

Once the authorization request message is received by the payment processing network **140** (step **S708** of FIG. 7), the payment processing network **140** may use the MVV stored in the authorization request message **M306** to retrieve information related to the merchant. As an example, upon receipt of the authorization request message **M306**, the payment processing network **140** may utilize the MVV included in the authorization request message to determine if the merchant participates in the tokenization service. If so, the payment processing network **140** can retrieve the TDK associated with the MVV (step **S710** of FIG. 7) and send the card account identifier and the TDK to a tokenization module **226**. This is shown as message **M308**. The tokenization module **226** may use the TDK to generate an account token based on the token derivation key (step **S711** of FIG. 7). The tokenization module **226** may ensure that the account token is unique for each account identifier, and may guarantee that the same account identifier will generate the same account token when the same

13

TDK is used. The tokenizing function may also prevent, absent the TDK, recovery of the account identifier from the account token.

In example embodiments, the TDK assigned to merchant computer 120 is securely housed in the payment processing network 140, and is not communicated or otherwise known to external parties. However, if the TDK is somehow compromised for a specific merchant (e.g., the merchant associated with merchant computer 120), the payment processing network 140 may generate a new TDK for the specific merchant and link the generated TDK with a TDK index. In an example embodiment of the invention, the first generated TDK may be linked with a beginning index (e.g., zero or one) and each successive TDK index generated by the payment processing network may be incremented by a determinable number, such as one. Thus, the TDK index linked to the merchant's original TDK may have the value of zero, the second TDK may be linked with a TDK index with a value of one, the third TDK may be linked with a TDK index with a value of two, and so on.

In other embodiments of the invention, the TDK index is a hidden index. Examples of hidden indexes are numbers produced by a random number function or indexes that are otherwise hidden. For example, the payment processing network 140 may apply such incremental indices described above to a hash function or decryption algorithm. An advantage of using a hidden index is that it provides an additional level of separation to the tokenization scheme. This is because hidden indices hide the relationship between prior and later indices. To illustrate, in an incrementing scheme without hidden indices, a fraudster may observe that two frequently occurring account tokens may represent the same underlying account identifier if the ending of occurrences of one of the account tokens coincides with the beginning of occurrences of the other and if the TDK indices for the two account tokens are one off from each other.

The payment processing network 140 may log the TDK index for every transaction. In this way, for each transaction, the payment processing network 140 may determine the token derivation key used to generate the account token regardless of subsequent token derivation key changes. As shown in FIG. 3, a TDK index may be sent to the tokenization module 226 (see message M308).

Message M314 is an authorization request message that is sent to an issuer computer 160. With reference to FIG. 7, this is shown as step S712. In the typical case, an issuer computer 160 performs its functions by using an account identifier and, as a result, may not have a use for an account token. In such cases, the tokenization server 220 can send message M314 independent of when the token derivation key is selected and the account token is generated. Accordingly, the steps of generating an account token can operate in parallel with the steps of sending an authorization request message M314 to issuer computer 160 and receiving authorization response message from the issuer. This is shown in FIG. 7 as steps S710 and S711 are performed as part of a separate path than steps S712 and S714.

When an authorization response message is received from the issuer computer 160 (step S714), the tokenization server 220 may embed the account token and the optional token derivation key index in the authorization response message M310. This embedding is shown as message M310.

If authorized, the payment processing network 140 may return the account token and the TDK index (if utilized by the payment processing network 140) to the acquirer computer 130 and/or merchant computer 120 in specified fields of the authorization response message M312. This is shown in FIG.

14

7 as steps S716. As described above, the payment processing network 140 may also log the account token and the TDK index for the corresponding transaction.

After the acquirer computer 130 receives the authorization response message M312, the acquirer computer 130 may then send the authorization response message M312 to the merchant computer 120 to be stored in token database 126. This is shown in FIG. 7 as step S705.

The payment processing network optionally provides the ability for the merchant computer 120 to use the account tokens to request the account identifiers to be sent back to the merchant computer 120. Via a mechanism (e.g., batch, online, remote web interfaces, etc.) the merchant computer 120 can submit the MVV, TDK index, and associated account token(s). The payment processing network 140 can then recover the original card account identifiers for secure transmission back to the merchant if the payment processing network 140 logged the transaction information.

An additional advantage of the embodiments is that it allows a comparatively efficient method and system to provide merchants and/merchant acquirers account tokens. In particular, once a merchant is registered, embodiments do not require separate or additional requests for tokenization. Instead, the payment processing network automatically provides an account token as part of the authorization process. Further, because the payment processing network utilizes the MVV and account identifier stored in the authentication request message (e.g., as stored in field 2 and field 62.20, respectively), embodiments may result in little, if any, changes to how authentication request messages are presently generated.

#### C. Multiple Merchants

As described above, the tokenization process communicates account tokens between the merchants and the payment processing network 140 as part of an authorization request and response. FIGS. 4-5 are block diagrams that show an exemplary embodiment that receives an authorization request message, generates an account token in response to receiving the authorization request message, and then inserts the generated account token in an authorization response message that is sent back to the merchant. In particular, FIGS. 4-5 highlight, among other things, how embodiments of the present invention can generate, for a single account identifier, account tokens that vary across different merchants but are consistent for the same merchant.

In particular, FIG. 4 shows merchant computer 120 sending an authorization request message M402 to the payment processing network 140. Authorization request message M402 can be an authorization request message sent in response to consumer 110 swiping a credit card at the merchant's access device 125. Alternatively, message M402 can be an authorization request message received by the tokenization server 220 when consumer 110 makes an Internet purchase from the merchant's web site. In any case, the authorization request message M402 can include transaction data, such as information derived from the card (e.g., the account identifier M402(b)), the terminal (e.g., the merchant verification value M402(d)), the transaction (e.g., the amount M402(c)), together with other data which may be generated dynamically or added by intervening systems (e.g., the header M402(a)). Although FIG. 4 shows the merchant computer 120 sending authorization request message M402 to the tokenization server 220, such messages can be sent through an acquirer computer 130, as is described above.

In some embodiments, authorization request message M402 can be in the form of an ISO (International Organization for Standardization) 8583 message. In other embodi-

15

ments, authorization request message M402 can take the form of a web based call to a web service offered by the tokenization server 220. For example, the authorization request message M402 can be in the form of an XML message.

Once the tokenization server 220 receives the authorization request message M402, the authorization request module 230 can validate the authorization request message M402 and then can route the authorization request message M402 to the issuer computer 160 in the form of authorization request message M404. FIG. 4 shows that much of the information found in authorization request message M402 is also included in authorization request message M404. Although not shown, authorization request message M404 can include additional information, according to some embodiments. For example, some embodiments can include routing information that describe the payments systems that have received the authorization request message.

In addition to verifying the authorization request message M402 and routing authorization request message M404 to issuer computer 160, the tokenization server 220 can also generate an account token for the account identifier associated with the authorization request message M402. The steps for generating the account token for the account identifier associated with the authorization request message M402 can begin before the tokenization server 220 receives an authorization response message M406. FIG. 4 shows that authorization request message M402, or some portion thereof, is received by the tokenization module 226. Once the tokenization module 226 receives authorization request message M402, the tokenization module 226 can search for the token derivation key associated with the merchant using the MVV of the authorization request message. For example, FIG. 4 shows that the value of the MVV of authorization request message M402 is '1001001'. The tokenization module 226 then can search the TDK database 246 for a token derivation key associated with '1001001'. According to FIG. 4, the TDK associated with '1001001' is 'TDKA'. Accordingly, the tokenization module 226 can access the TDK database 246 to retrieve the appropriate token derivation key associated with merchant computer 120.

After the tokenization module 226 retrieves the token derivation key associated with the MVV, the tokenization module 226 can generate the account token for the account identifier of the authorization request message M402. As described above, the tokenization module 226 can use a variety of methods for generating account tokens. In one embodiment, the tokenization module 226 applies a symmetric encryption algorithm to the account identifier. The token derivation key associated with the MVV can be used as the key for the symmetric encryption algorithm.

The generated account token is then sent to and received by the authorization response module. This is shown as message M403.

Upon receiving the authorization request message M404, the issuer computer 160 can analyze the authorization request message M404 and make a determination on whether the transaction should be authorized or not. If the issuer 160 verifies that the transaction can proceed, the issuer 160 can send an authorization response message to the payment processing network 140. This is shown as authorization response message M406.

FIG. 4 shows that the account token M403 and the authorization response message M406 are received by the authorization response module 224. In some embodiments, because the tokenization module 226 and the authorization request module 230 operate independently, the authorization response module 224 can receive the account token M403 and

16

the authorization response message M406 in any order. When both the account token M403 and the authorization response message M406 are received, the authorization response module 224 can then send the authorization response message M408 to the merchant 120.

Authorization response message M408 can be in any form. In some embodiments, authorization response message M408 generally takes the form of an ISO 8583 message with account token embedded in the fields. The authorization response message M408 may include a header M408(a) that indicates that the message is an authorization response message and a response code M408(c) to indicate whether the authorization request is authorized or denied. As described above, these are fields generally provided by the authorization response message M406 sent by the issuer computer 160. It should be noted that the indication that the message is an authorization request message or an authorization response message need not be included in headers 402(a) and 408(a), respectively. For example, as described below with respect to FIGS. 6A-E, the messages may include a message type field 604 that specifies the message class and category of function. Returning to FIG. 4, the authorization response module 224 can embed the account token in field M408(b) of the authorization response message M408 that is sent to the merchant computer 120. In some embodiments, as described below, the authorization response module 224 can also embed a token derivation key index in the authorization response message M408 that is sent to the merchant 120 computer.

As is described in greater detail below, with reference to FIGS. 6A-E, the format of an authorization response message storing an account token can vary according to embodiments of the present invention.

After the authorization response module 224 sends the authorization response message M408, the authorization response message M408 can be received by the merchant computer 120. Although not shown in FIG. 4, the merchant computer 120 can receive the authorization response message M408 via the acquirer computer 130. The merchant computer 120 can then store the account token 128, as well as other transaction data, in analytics database 126. The analytics database 126 does not include any indication of the account identifier used in the transaction, according to example embodiments.

If at some later point in time, the consumer 110 makes another purchase at merchant 120 with the portable consumer device 115, the tokenization server 220 may generate an account token with the same value as the sent in authorization response message M408. That is, the merchant 120 may receive another account token with the value ABCDE.

However, if at some later point in time, the consumer 110 makes another purchase with the portable consumer device 115 at a different merchant, the tokenization server 220 may generate an account token with a different value. For example, FIG. 5 shows another payment transaction processed by the tokenization server 220. As shown in FIG. 5, authorization response messages M502, M504 involve transactions using the same account identifier used in FIG. 4. In particular, account '12345' is used to make a purchase at a merchant. However, the payment transaction involves a different merchant than the one used in FIG. 4. This is shown in the merchant verification value of the authorization requests M502, M504, where the merchant verification value involved in the transaction is '2003004'.

In comparison to the payment transaction processed in FIG. 4, the tokenization module 226 may receive the merchant verification value of '2003004' contained in the authorization request message M402. Using the merchant verifica-

tion value, the tokenization module 226 can retrieve token derivation key B from the TDK database 126. The tokenization module 226 may then use the token derivation key B to generate the account token for the account identifier stored in the authorization request message M502. The tokenization module 226 can then send the generated account token to the authorization response module 224 to generate an authorization response message M508 that is sent to merchant 121. It is to be noted that the token 508(b) may differ from the token generated for merchant computer 120. In turn the merchant 121 can store the account token 129 in analytics database 127. Later, the merchant 121 can use the account token 129 to perform analytics or supplementary processing.

#### D. Authorization Response Message Formats

As described above, an authorization response message can include an account token that is generated based on an account identifier and a merchant verification value. As is further described above, the account token can be embedded in the authorization response message in any number of ways. For example, FIGS. 6A-E are diagrams that show different ways an account token can be embedded in the authorization response message. In particular, FIG. 6A is a diagram showing an authorization response message 600a that stores an account token in a field of the authorization response message. As shown in FIG. 6A, the authorization response message 600a can include a message header field 602, a message type field 604, a bit map field 606, and a number of data fields 608.

The message header field 602 can contain basic message identifiers and routing information along with message processing control codes and flags.

The message type field 604 can specify the message class and the category of function. For example, a message type field 604 value of '0110' can indicate an authorization response message.

The bit map field 606 can specify which data fields are in an authorization response message. For example, a first bit in the bit map field 606 may indicate if a first type of data field is present in the data fields 608, a second bit in the bit map field 606 may indicate if a second type of data field is present in the data fields 608, and a nth bit in the bit map field 606 may indicate if a nth type of data field is present in the data fields 608. A bit map field can be of any size. In example embodiments, a bit map field is a 64-bit field.

The data fields 608 can include any number of fields used to process a message. For example, some fields may indicate a response code (e.g., whether a payment request is authorized or rejected). In particular, the data fields 608 can include an account token field 610. The account token field 610 can store the account token corresponding to an account identifier sent via a corresponding authorization request message. It is to be noted that when an account token field is present in the authorization response message, an appropriate bit in the bit map field 606 can be set.

Alternatively, an authorization response message can include a token derivation key index associated with the token derivation key used to generate the account token. As described above, providing a token derivation key index to the merchant computer allows the merchant computer to request the tokenization server 220 to return back the account identifier associated with the account token. FIGS. 6B, 6C, and 6D are diagrams showing authorization response messages 600b, 600c, 600d that store a token derivation key index. For example, as shown in FIG. 6B, an account token and a token derivation key index can be stored in single data field 620 as sub-fields 622, 624 of authorization response message 600b. According to some embodiments, sub-fields 622, 624 can be

of predetermined length. Alternatively, as shown in FIG. 6C, the account token and token derivation key index can be stored in a single data field 630 of authorization response message 600c but may include a separation symbol 632 to indicate where within data field 630 the account token ends and the index begins (or vice versa). Although the separation symbol 632 is shown to be a '/', it is to be appreciated that any other suitable symbol can be used. Using a separation symbol allows for variable length account tokens and token derivation indexes. Still further, in other embodiments, as shown in FIG. 6D, the account token and token derivation key index can be stored in separate data fields 640, 642 of the authorization response message 600d. Accordingly, the bit map field 644 of the authorization response message 600d may include a first indication that the account token field 640 is present and a second indication that the token derivation key index data field 642 is present.

FIGS. 6A-D describe authorization response message formats that rely on structured placement of the account token and/or index. However, other embodiments can use techniques that provide greater flexibility for the location and content of the data fields stored in the authorization response message. For example, FIG. 6E shows a simplified diagram illustrating a markup representation of the authorization response message. Instead of relying on a bit map, such as may be present in FIGS. 6A-D, the authorization response message can be sent in a form that uses tags to identify data and attributes to describe characteristics of the data. For example, the authorization response message can include a message tag 652 to identify that the message is an authorization response message. Further, the message tag 652 can include a number of sub-tags to represent the various fields of the authorization response message. As shown, field tag 651 includes a type attribute 653 and an index attribute 654. The type attribute 653 identifies that the type of field is a token field. The optional index attribute 654 identifies the index associated with the account token. The tag content 655 indicates the value of the account token, 'ABCDE'. Although not shown in FIG. 6E, the field tag 651 can optionally include an end tag.

FIG. 6E is just an example of one format for a markup representation of the authorization response message. Other embodiments can use alternative markup representations.

#### V. Account Identifier Substitution for Support Systems

Section IV describes techniques for communicating account tokens to a merchant computer. Such account tokens can be sent to the merchant computer during the authorization of a payment request, for example, in an authorization response message sent from the tokenization server to the merchant computer via an acquirer computer. In addition to communicating account tokens to a merchant, a tokenization server may also communicate with a number of support systems. Such support systems, as described above, may perform primary and auxiliary functions involved with authorizing, settling, and clearing transactions. The support systems may reside within a payment processing network or as an external partner that is in operative communication with the payment processing network. This section now describes methods, systems, and apparatuses for communicating an account token to these support systems.

##### A. System for Providing Account Tokens to a Support System

FIG. 9 is a block diagram that shows messages exchanged within a system 900 that communicates account tokens to a number of support systems. In certain embodiments, a payment processing network 140 may be in operative communication with one or more acquirer computers 130 via the Internet or some other communication medium.

19

In embodiments of the invention, the payment processing network **140** may be in further operative communication with a support computer **150**. The support computer **150** may perform supporting functions for the payment processing network **140** via support modules **22** and **24**. An example of a supporting function is scoring a transaction for fraud.

As an illustration of the interaction between the payment processing network **140** and the support computer **150**, a payment transaction is initiated by the acquirer computer **130** when a consumer **110** conducts a transaction with a merchant associated with merchant computer **120** via the access device **125**. As described above, the acquirer computer **130**, for example, may be operated by a banking institution that oversees an account associated with the merchant. The acquirer computer **130** may transmit an authorization request message to the payment processing network **140** and the authorization request message may be received by the tokenization server **220**. In turn, the tokenization server **220** may transmit at least some portion of the authorization request message to other systems. For example, the tokenization server **220** may transmit the account identifier to supporting module **16**. Further, the account identifier may be communicated to the support module **24** of the support computer **150**.

Although the payment processing network **140** may need the account identifier for any number of reasons, such as moving money, checking status, and reporting, some of the support computers may not. For example, a support computer may only use the account identifier as an identifier or unique index. Exacerbating security risks associated with the use of account identifiers, these support computers may store the account identifier in various databases, problem logs, dump logs, core dumps, and other similar memory storages and data structures. Thus not only is the account identifier potentially exposed to fraudsters when the account identifier is transmitted between different systems but there is also a risk that a fraudster may obtain the account identifiers by hacking into these support computer, even long after the transaction has been conducted. Accordingly, the payment processing network **140** may improve security of an account identifier by communicating account tokens rather than account identifier, where possible.

As shown in FIG. 9, the acquirer computer **130** may communicate the account identifier to the payment processing network **140**. In particular, the tokenization server **220** may receive a primary account number **912**. If the tokenization server **220** determines that the primary account number is new to the tokenization server **220**, the tokenization server **220** may generate an account token of the account identifier. Otherwise, the tokenization server **220** can use the account token previously generated for the account identifier. The account token can be used to identify an account, account identifier, and/or a transaction. The account token may include card characteristics or, in some example embodiments, the card characteristics may be data distinguishable from the account token. The tokenization server **220** may then store the generated account token and, if present, the associated card characteristics. In some embodiments, the characteristics are updated as a change is noticed or periodically refreshed.

Once the tokenization server **220** generates or identifies the account token associated with the primary account number **912**, the tokenization server **220** may communicate the account token to the support modules that do not require the account identifier (e.g., primary account number **912**).

As part of the process of determining whether a support system requires an account identifier, the tokenization server **220** may query support system database **246** (see FIG. 2) to

20

determine whether the account identifier is required for a specified support system. In such an embodiment, the tokenization server **220** may lookup the support system according to a support system verification value assigned to the support module when the support module is enrolled with the tokenization server **220**. For example, support system database **246** may indicate that the support module **16** requires an account identifier while the support module **18** does not require an account identifier or can accept an account token in lieu of an account identifier. Accordingly, after making the determination, the tokenization server **220** will transmit the account identifier to support module **16** and an account token to support module **18**. A similar process can be used for the support modules **22**, **24** residing on the support computer **150**.

Alternatively, whether or not a support module requires an account identifier or can instead accept an account token may be determined by manual configuration (e.g., input received by an administrator of the payment processing network **140**) or via an application programming interface (API) of the support computer **150** that may allow the tokenization server **220** to interrogate the various support modules **22**, **24** as to their requirements as it relates to receiving an account identifier or an account token.

Embodiments of the invention provide numerous advantages in the development of secure data centers. In particular, embodiments of the invention enable the development of comparatively more secure transactions that transmit an account identifier. Embodiments of the invention can provide such results because they utilize an account token rather than sensitive data, such as the account identifier. Specifically, embodiments of the invention generate account token data that is associated with a account identifier and then communicate the account token data rather than the account identifier to the various support systems. Use of the account token data reduces the risks of communicating the account identifier to various support systems as well as storing sensitive data within such systems.

B. Method for Providing Account Tokens to a Support System

FIG. 10 is a flow diagram showing a method **1000** of providing an account token to a support system. The steps performed by the method **1000** can be performed by the tokenization server **220** or by any other suitable module of the payment processing network **140**. In alternative embodiments, one or more steps described herein can be performed by any other suitable computer system, such the issuer computer **160**, for example.

The method **1000** may begin by enrolling a support module with the tokenization server **220**. This is shown as step **S1002**. A support module may be running within the payment processing network **140** (e.g., support modules **16**, **18**) or within a support computer **150** that operates external and independent of the payment processing network **140** (e.g., support modules **22**, **24**). Enrolling a support module can involve, in some embodiments, communicatively connecting the support module to the tokenization server. For example, the support computer may offer the support module as a web service. In such cases, the tokenization server **220** (or the payment processing network **140** in general) and the support computer **150** may communicate using an APIs defined by each entity. Alternatively, the support modules may be deployed by the system administrator of the payment processing network **140**. In such cases, the support module may be deployed wholly within the payment processing network **140**, external to the payment processing network **140**, or some combination thereof. The enrollment process, whether offered as a web service or as a deployed system, may indicate whether the support module is to receive an account identifier or an

## 21

account token in later communications. Such information may be stored in the support system database 246 (see FIG. 2) or may be accessible via an interface provided by the support module.

Once enrolled, the tokenization server 220 may receive a payment message. This is shown as step S1004. As used herein, a “payment message” can refer to either an authorization request message or an authorization response message, which are described above.

After receiving the payment message, the tokenization server 220 may determine if a support module can receive an account token. This is shown as step S1006. The tokenization server 220 can determine if the support module can receive an account token using the information received when the support module was enrolled with the tokenization server 220. For example, the tokenization server 220 may access support system database 246 to determine whether a specific support module can receive an account token.

Step S1008 is a decision point on whether the support module can receive an account token, as is determined in step S1006. If yes, step S1010 is then performed. Otherwise, step S1014 is performed.

Step S1010 involves generating an account token from the account identifier included in the payment message (see step S1004). The tokenization server 220 may generate an account token for the account identifier using any of the methods or techniques described above. For example, the tokenization server 220 may encrypt the account identifier using any suitable encryption method. In some embodiments, a single token derivation key is used for tokenizing account identifiers for all support modules. In other embodiments, each support module, or a group of support modules, is assigned a specific token derivation key that is used to generate the account token. As described above, assigning different token derivation keys to different support modules can add an additional level of security among the different support modules.

After the account token is generated, the tokenization server 220 can then transmit an external request message to the support module, wherein the external request message includes the account token. This is shown as step S1012. As used herein, an “external request message” can refer to a message that is sent to the support module that causes the support module to provide its supporting function. In some embodiments, the external request message is sent according to an API provided by the support module. For example, the support module can provide a SOAP (Simple Object Access Protocol) procedure that can be used to receive and transmit information from and to the tokenization server 220. The SOAP procedure may then provide an implementation of a web service provided by the support module. XML can be used to define the message formats for the messages sent between the support module and the tokenization server 220. Again, examples of such procedures may relate to scoring a transaction for fraud, generating alerts to a customer or merchant, reporting, etc.

As described above, if the support module can not receive an account token based on decision step S1008, step S1014 is then performed. According to step S1014, the tokenization server 220 transmits an external request message to the support module with the account identifier. Such an external request message can be sent according to the techniques described above, as it relates to step S1012.

After the external request message is sent to the support module, the tokenization server 220 can receive an external response message from the support module. This is shown as step S1016. As used herein, an “external response message” can refer to a message that is sent back to the tokenization

## 22

server 220 from the support module in response to processing the external request message. In some embodiments, the external response message is a response message sent according to a SOAP procedure call. XML can be used to define the message format of the external response message. The external response message can include an indication of the web service initiated by the external request message. For example, the external response message can include a field that indicates whether the support function completed successfully or can include specific information, such as the fraud score of a transaction.

After receiving the external response message, the tokenization server 220 can send a payment message. This is shown as step S1018. As described above, a payment message can be an authorization request message. For example, the tokenization server 220 may have sent the external request message to a fraud scoring system in step S1012. In response to receiving the fraud score in the external response message in step S1016, the tokenization server 220 can forward an authorization request message with the fraud score to the issuer computer 160. The issuer computer 160 can then process the authorization request message and use the fraud score to determine whether the transaction is authorized.

Alternatively, also described above, a payment message can be an authorization response message. For example, the tokenization server 220 may have sent the external request message to a reporting system that can generate reports of transaction histories based on a number of categories. Because the reporting system is not used by the issuer computer 160 as it relates to determining whether a transaction is authorized, the tokenization server 220 can send the external request message after the tokenization server 220 receives the authorization response (e.g., in step S1004). Accordingly, the payment message involved in step S1018 is an authorization response message that may be sent back to the acquirer computer.

Whether the payment message is an authorization request message or an authorization response message, the payment message may include external system data. As used herein, “external system data” can refer to any information obtained from the support module that is to be communicated to an external entity, such as a merchant computer or an issuer computer. For example, external system data can refer to an offer or reward that a consumer obtains after a predetermined number of purchases at a store. As another example, external system data can refer to a risk score that is sent to an issuer so that the issuer can determine whether to authorize the payment request.

Step S1018 can also include determining the account identifier from the account token stored in the external system data. This step may allow the tokenization server 220 to route the payment message to the appropriate merchant computer, for example.

It is to be noted that the timing of when the various steps of the method 1000 are performed may vary according to example embodiments. For example, in some embodiments the authorization process operates independent of the function performed by the support module. In such cases, steps S1016 and S1018 can be performed in any order. Such may be the case where the support module merely logs transactions, for example.

VI. Provisioning Account Tokens for Merchant Support Systems

FIGS. 3, 4, 5, 6A-E, and 7 describe various embodiments that, in response to an authorization request message, send a merchant specific account token to a merchant in an authorization response message. In comparison, FIGS. 9 and 10

describe embodiments that, in response to an authorization request message, send account tokens to a support system of the payment processing network.

Although not yet discussed, a merchant may wish to communicate its merchant specific account tokens to a support system. To illustrate, a merchant computer can use a third-party to provide risk analysis services. Accordingly, when a merchant receives an authorization response message with an account token from a payment processing network, the merchant can then send the authorization response message, or portions thereof, to the third-party service provider for further processing. Communicating the account token to the third-party service provider is comparatively secure because the account token can not be used to conduct a transaction. When the third-party service provider receives the account token, it can, for example, compare the account token against a database that stores high risk account tokens and report a risk score back to the merchant.

In order to provide improved risk analysis, it may be desirable for the third-party service provider to compare account tokens it receives from one merchant against account tokens it receives from another merchant. However, as described above, the account tokens that the payment processing network sends to the merchants are specific to that merchant. That is, for a given account identifier, the account token generated for one merchant is going to be different than the account token generated for another merchant. As a result, the third-party service provider will be unable to determine if a first account token from a first merchant and a second account token from a second merchant are associated with the same underlying account identifier. This example illustrates the difficulty of analyzing account tokens across different merchants.

FIGS. 11 and 12 illustrate various approaches that address these and other limitations for third-party support for processing account tokens across multiple merchants.

To begin, FIG. 11 is a block diagram that shows a system 1100 that includes merchants 120, 121, a merchant support server 1102, and the tokenization server 220. As shown, merchants 120, 121 may each store account token data in their respective account token databases, 126, 127. Such account tokens can be obtained using the techniques described above. As a result, the account token databases 126, 127 may each store merchant specific account token sets 126(a), 127(a). For simplicity of illustration, account token databases 126, 127, as shown in FIG. 11, can store account tokens for each transaction. However, in other embodiments, additional information can be stored, such as a token derivation key index, and other transaction data, such as time of day, date, location, MVV, merchant category, etc.

FIG. 11 shows that account token database 126 may store account tokens for transactions T1-T3 wherein the three transactions involve only two unique account tokens: '12345', which is involved in two transactions; and '67890', which is involved in one transaction. In comparison, account token database 127 may also store account tokens for transactions T4-T6, wherein the three transactions also involve only two unique account tokens: 'ABCD', which is involved in two transactions; and 'BCDE', which is involved in one transaction. Thus, based on a comparison of merchant specific account tokens 126(a), 127(a), it would appear that transactions T1-T6 involve four account tokens (i.e., '12345', '6789', 'ABCD', and 'BCDE'), wherein two of the account tokens are each involved in two transactions (i.e., '12345' and 'ABCD'), and the remaining two account tokens are each involved in one transaction (i.e., '6789' and 'BCDE').

To enable the merchant support server 1102 to analyze the merchant specific account tokens 126(a), the merchants 120 may send message M1110A to the merchant support server 1102. Message M1110A can include the merchant verification value associated with merchant computer 120, one or more of the merchant specific account tokens 126(a), and any other transaction data. Message M1110A can be sent to the merchant support server 1102 in response to receiving an authorization response message from the payment processing network 140. Such may be the case when the merchant support server 1102 is involved in the authorization process. Alternatively, the merchant computer 120 may send message M1110A as part of a batch processes that runs periodically or at set times.

Similarly, merchant 121 can send message M1110B to the merchant support server 1102 to communicate its merchant specific account tokens 127(a) to the merchant support server 1102.

When the merchant support server 1102 receives messages M1110A and/or M1110B, the merchant support server 1102 may send a normalization request message M1112 to the tokenization server 220. FIG. 11 shows that the normalization request message M1112 can include multiple verification values. For example, the normalization request message M1112 can include a verification value associated with the merchant support server 1102 (e.g., SSVV). The tokenization server 220 can use the verification value associated with the merchant support system 1102 to identify the requester of the normalization request. Further, FIG. 11 shows that the normalization request message M1112 can include a merchant verification value associated with a merchant (e.g., MVV1 or MVV2) and merchant specific account tokens.

Once the tokenization server 220 receives the normalization request message M1112, the tokenization server 220 can authorize the request to normalize the account token. In one embodiment, prior to sending message M1110A, merchant 120 can register the merchant support server 1102 as a trusted support system. In this case, the tokenization server 220 can store this relationship in the support system database 246. Accordingly, in one embodiment, the tokenization server 220 can search the support system database 246 using the merchant verification value assigned to the merchant to determine whether the merchant previously registered the merchant support server 1102 as a trusted support system. Alternatively, in another embodiment, the tokenization server 220 can search the support system database 246 using the verification value of the merchant support server 1102 to determine whether the merchant previously registered the merchant support server as a trusted support system.

After the tokenization server 220 determines that the merchant support server 1102 is authorized to normalize the account token data, the tokenization server 220 can reverse tokenize the merchant specific account tokens to obtain the account identifier. In an example embodiment, the normalization module 228 (see FIG. 2) can normalize the account tokens. For example, with regard to merchant 120, the normalization module 228 can use the merchant verification value of the merchant 120 (e.g., MVV1) to search the TDK database 244 to find the token derivation key associated with merchant 120. Once the appropriate token derivation key is located, the normalization module 228 can then reverse tokenize the account token using the token derivation key assigned to merchant 120. This process is appropriate for those embodiments that use symmetric derivation keys. For embodiments that use asymmetric derivation keys, the TDK database 244 may store a token reverse key, which is similarly associated with the merchant verification value. Accordingly,



25

rather than reverse tokenizing the account token with the token derivation key, the normalization module 228 can reverse tokenize the account token into the account identifier with the token reverse key. Whether a token derivation key is symmetric or asymmetric, a token derivation key index may also be required to reverse tokenize the account token.

The above described approach can be used with respect to any other merchant, such as merchant 121, and the other merchant's account tokens.

Once the normalization module 228 transforms the account tokens back to the underlying account identifiers, the normalization module 228 then searches the TDK database 244 for the token derivation key assigned to the merchant support system 1102. With the token derivation key assigned to the merchant support system 1102, the normalization module 228 can then generate new account tokens of the account identifiers. This new set of account tokens can be referred to as normalized account tokens.

After the normalization module 228 generates the normalized account tokens, the tokenization server 220 then sends the normalized account tokens to the merchant support server 1102. This is shown as message M1114, as a normalization response message. The merchant support server 1102 can store the normalized account tokens in the normalized account token database 1104. As shown in FIG. 11, the normalized account token database 1104 stores normalized account tokens 1104(a) that correspond to the six transactions in the merchant account token databases 126, 127. However, rather than linking the six transaction with the merchant specific account token (e.g., 126(a) and 127(a)), the transactions are linked to the normalized account tokens 1104(a).

As FIG. 11 shows, the normalized account tokens 1104(a) provides additional insight into the six transactions conducted by merchants 120, 121. For example, as described above, a comparison of merchant specific account tokens 126(a), 127(a) does not indicate that transactions 1 and 4 were conducted with the same account identifier because the respective account tokens differ (e.g., '12345' and 'ABCD', respectively). However, based on the normalized account tokens 1104(a), it is clear that transaction 1 and transaction 4 were conducted with the same account identifier because both transactions involve the same normalized account token, (i.e., '54321'). Further, after normalization, the normalized account tokens 1104(a) stored in the normalized account token database 1104 indicate that the six transactions are actually conducted with only two different account identifiers.

The normalization approach described above provides a number of additional advantages. For example, because systems external to the payment processing network store account tokens rather than account identifiers, these systems do not have to provide costly safety systems to ensure they comply with various security standards. In particular, the merchant support server 1102 can be completely shielded from receiving or even communicating account identifiers.

The approach described with respect to FIG. 11 may be well suited for situations that involve batch processing. For example, the merchant support system 1102 may provide a rewards program across merchants. As such, its support function may be run nightly, weekly, monthly, etc. However, because the technique described in context with FIG. 11 involves additional messages communicated between a merchant support system 1102 and the tokenization server 220, such an approach may not be appropriate if the merchant needs a real time response, such as a fraud alert.

FIG. 12 is a block diagram that shows an alternative approach for normalizing merchant specific account tokens to

26

allow a merchant support server 1102 to compare account tokens across multiple merchants. Compared to system 1100, the system 1200 shown in FIG. 12 may be better suited for real time analysis offered by the merchant support server 1102.

In some embodiments, before the tokenization server 220 can provide a normalized account token for account identifiers involved in transactions with merchant 120, merchant 120 may enroll the merchant support server 1102 as a support system of merchant 120. This is shown as message M1210A. Message M1210A can include the merchant verification value of the merchant 120 and a support system verification value for the merchant support server 1102. For example, merchant 120 may be assigned the merchant verification value 'M1210A' and the third party support system 1102 can be assigned the support system verification value 'SSVV'. When a merchant enrolls a merchant support server as a service system of the merchant, the tokenization server 220 creates an association between the verification value of the merchant and the verification value of the merchant support server 1102. As shown in FIG. 12, record 1204 of normalization database 1207 may link various information used to tokenize account identifiers for merchant computer 120. For example, the merchant verification value (e.g., 'M1210A') assigned to the merchant computer 120 can be linked to token derivation key (e.g., 'Key A') assigned to merchant 120. Further, after enrolling the merchant support server 1102 as a support system of the merchant 120, the record 1204 may include a support system verification value (e.g., 'SSVV') assigned to the merchant support server 1102.

The record 1205 may include various information used to transform the account identifiers into a normalized account token. For example, the support system verification value (e.g., SSVV) can be linked to a token derivation key (e.g., Key C) that is used to tokenize account identifiers in a format specific to the merchant support server 1102. Records 1204, 1205 can be indexed by any suitable field, such as merchant or support system verification value.

Although FIG. 12 shows database 1207 storing the associations between the merchant verification values, support system verification values, and token derivation keys, it is to be appreciated that any combination of the databases 242, 244, and 246 (see FIG. 2) can be used to store such information.

Merchant 121 can enroll the merchant support server 1102 as a support system in a similar manner.

Once the merchant support server 1102 is enrolled as a support system for the merchants, merchant 120 can send an authorization request message to the tokenization server 220 in the typical fashion, as may occur when a consumer swipes their credit card at a POS terminal. This is shown as message M1212A. The authorization request message can include information shown in FIG. 4. For example, the authorization request message may include the merchant verification value assigned to merchant 120 and an account identifier. Upon receiving the authorization request message M1212A, the tokenization server 220 can process the transaction as described above. That is, the authorization request M1212A can be received by the authorization request module 230. The authorization request module 230 can then forward the authorization request message to the issuer computer 160 of the portable consumer device 115. In parallel, while the authorization request message is received by the authorization processing module 230, the tokenization module 226 can receive the account identifier and merchant verification value stored in the authorization request message. Using the merchant verification value, the tokenization module 226 may identify

the token derivation key assigned to the merchant and then generates an account token using the token derivation key.

Additionally, the tokenization module 220 can use the merchant verification value to determine that the merchant support server 1102 is enrolled as a support system for the merchant 120. For example, the normalization module 228 can use the merchant verification value sent in the authorization request message to search database 1207 for a record associated with the merchant. For example, record 1204 can be indexed by the merchant verification value, in which case the normalization module would match record 1204 with the merchant verification value 'M1214B', and send the account token based on the token derivation key assigned to the merchant support server 1104 (M1216B).

Further, the technique of generating account tokens in response to authorization request messages and sending the account tokens in authorization response messages can be repeated for one or more transactions. For example, as FIG. 12 shows, as was shown in FIG. 11, merchant 120 may store merchant specific account tokens 126(a) corresponding to three transactions, while merchant 121 may store merchant specific account tokens corresponding to three additional transactions. Similar to FIG. 11, collectively, the merchant specific account tokens 126(a), 126(b) provide relatively little information regarding the combined transactions. However, as shown in the merchant support server 1104, the normalized account tokens 1104(a) stored normalized database 1104 illustrate that transaction 1 and transaction 4 actually involve the same underlying account identifier.

However, unlike the embodiments described with reference to FIG. 11, embodiments according to FIG. 12 provide an improved technique for providing normalized account tokens if the normalization tokens are to be analyzed in real-time. Such is the case because the normalized account tokens are generated by the tokenization server when the tokenization server receives an authorization request message. As such, the normalized account tokens can be generated in parallel to the processing of the merchant specific account token and in parallel to the issuer processing the authorization request message.

VII. Exemplary Computer Apparatuses

FIG. 8 shows a block diagram of an exemplary computer apparatus that can be used in some embodiments of the invention (e.g., in any of the components shown in the prior Figures).

Any of the elements in figures described herein can use any suitable number of subsystems to facilitate the functions described herein. System 800 in FIG. 8 is representative of a computer system capable of embodying various aspects of the present invention. The computer system can be present in any of the elements in figures described herein, including payment processing network 140, for example. Similarly, the various participants, entities and elements in FIG. 1 may operate one or more computer apparatuses to facilitate the functions described herein. It will be readily apparent to one of ordinary skill in the art that many other hardware and software configurations are suitable for use with the present invention.

For example, the computer may be a desktop, portable, rack-mounted or tablet configuration. Additionally, the computer may be a series of networked computers. Further, the use of other micro processors are contemplated, such as Xeon™, Pentium™ or Core™ microprocessors; Turion™ 64, Opteron™ or Athlon™ microprocessors from Advanced Micro Devices, Inc; and the like. Further, other types of operating systems are contemplated, such as Windows®, WindowsXP®, WindowsNT®, or the like from Microsoft Corporation, Solaris from Sun Microsystems, LINUX,

After determining that the merchant support server 1102 is a support system for merchant computer 120, the tokenization module 226 can generate an additional account token using the token derivation key assigned to the merchant support server. This can be done by passing the support system verification value assigned to the merchant support server 1102 and the account identifier sent in the authorization request message to the tokenization module 226. When the tokenization module 226 receives the account identifier and the support system verification value 'SSVV', it can search normalization database 1207 for the token derivation key assigned to the merchant support server 1102. For example, the tokenization module 226 can obtain the token derivation key assigned to the support system by matching record 1205 with the support system verification value stored in record 1204 (i.e., 'SSVV'), for example. After the tokenization module 226 locates the record associated with the merchant support server 1102, the tokenization module 226 can generate a second account token of the account identifier sent in the authorization request message using the token derivation key assigned to the merchant support server 1104.

After the tokenization module 226 generates the account token based on the token derivation key assigned to the merchant 120 and the account token based on the token derivation key assigned to the merchant support server, the tokenization server 220 can send the account tokens to the merchant 120. This is shown as message M1214A. For example, as explained above, the account token based on the merchant's 120 token derivation key can be inserted in an authorization response message. Further, the account token based on the token derivation key assigned to the merchant support server 1104 can similarly be inserted in the authorization response message.

When the merchant 120 receives the authorization response message M1214A, the merchant can then store the account token based on the token derivation key assigned to the merchant in token database 126. FIG. 12 shows that account token database 126 stores the account tokens for transactions T1-T3. In addition to storing the account token based on the token derivation key assigned to the merchant 120, the merchant 120 can also send the account token based on the token derivation key assigned to the merchant support server 1104 to the merchant support server for further processing. For example, the merchant support server 1104 can be configured to assign a risk score to a transaction. In this way, message 1216A can be part of an authorization process used by the merchant 120.

FIG. 8 shows a block diagram of an exemplary computer apparatus that can be used in some embodiments of the invention (e.g., in any of the components shown in the prior Figures).

Any of the elements in figures described herein can use any suitable number of subsystems to facilitate the functions described herein. System 800 in FIG. 8 is representative of a computer system capable of embodying various aspects of the present invention. The computer system can be present in any of the elements in figures described herein, including payment processing network 140, for example. Similarly, the various participants, entities and elements in FIG. 1 may operate one or more computer apparatuses to facilitate the functions described herein. It will be readily apparent to one of ordinary skill in the art that many other hardware and software configurations are suitable for use with the present invention.

For example, the computer may be a desktop, portable, rack-mounted or tablet configuration. Additionally, the computer may be a series of networked computers. Further, the use of other micro processors are contemplated, such as Xeon™, Pentium™ or Core™ microprocessors; Turion™ 64, Opteron™ or Athlon™ microprocessors from Advanced Micro Devices, Inc; and the like. Further, other types of operating systems are contemplated, such as Windows®, WindowsXP®, WindowsNT®, or the like from Microsoft Corporation, Solaris from Sun Microsystems, LINUX,

FIG. 8 shows a block diagram of an exemplary computer apparatus that can be used in some embodiments of the invention (e.g., in any of the components shown in the prior Figures).

Any of the elements in figures described herein can use any suitable number of subsystems to facilitate the functions described herein. System 800 in FIG. 8 is representative of a computer system capable of embodying various aspects of the present invention. The computer system can be present in any of the elements in figures described herein, including payment processing network 140, for example. Similarly, the various participants, entities and elements in FIG. 1 may operate one or more computer apparatuses to facilitate the functions described herein. It will be readily apparent to one of ordinary skill in the art that many other hardware and software configurations are suitable for use with the present invention.

For example, the computer may be a desktop, portable, rack-mounted or tablet configuration. Additionally, the computer may be a series of networked computers. Further, the use of other micro processors are contemplated, such as Xeon™, Pentium™ or Core™ microprocessors; Turion™ 64, Opteron™ or Athlon™ microprocessors from Advanced Micro Devices, Inc; and the like. Further, other types of operating systems are contemplated, such as Windows®, WindowsXP®, WindowsNT®, or the like from Microsoft Corporation, Solaris from Sun Microsystems, LINUX,

UNIX, and the like. In still other embodiments, the techniques described above may be implemented upon a chip or an auxiliary processing board. Various embodiments may be based upon systems provided by daVinci, Pandora, Silicon Color, or other vendors.

In one embodiment, computer system **800** typically includes a monitor **810**, computer **820**, a keyboard **830**, a user input device **845**, network interface **850**, and the like. In various embodiments, monitor **810** may be embodied as a CRT display, an LCD display, a plasma display, a direct-projection or rear-projection DLP, a microdisplay, or the like. In various embodiments, display **810** may be used to display user interfaces and rendered images.

In various embodiments, user input device **845** is typically embodied as a computer mouse, a trackball, a track pad, a joystick, wireless remote, drawing tablet, voice command system, and the like. User input device **845** typically allows a user to select objects, icons, text and the like that appear on the display **810** via a command such as a click of a button or the like. An additional specialized user input device **845**, such as a magnetic stripe, RFID transceiver or smart card reader may also be provided in various embodiments. In other embodiments, user input device **845** include additional computer system displays (e.g. multiple monitors). Further user input device **845** may be implemented as one or more graphical user interfaces on such a display.

Embodiments of network interface **850** typically include an Ethernet card, a modem (telephone, satellite, cable, ISDN), (asynchronous) digital subscriber line (DSL) unit, FireWire interface, USB interface, and the like. For example, network interface **850** may be coupled to a computer network, to a FireWire bus, or the like. In other embodiments, network interface **850** may be physically integrated on the motherboard of computer, may be a software program, such as soft DSL, or the like.

RAM **870** and disk drive **880** are examples of computer-readable tangible media configured to store data such user, account and transaction level data, calculated aggregated data, super keys, sub keys and other executable computer code, human readable code, or the like. Other types of tangible media include magnetic storage media such as floppy disks, networked hard disks, or removable hard disks; optical storage media such as CD-ROMS, DVDs, holographic memories, or bar codes; semiconductor media such as flash memories, read-only-memories (ROMS); battery-backed volatile memories; networked storage devices, and the like.

In the present embodiment, computer system **800** may also include software that enables communications over a network such as the HTTP, TCP/IP, RTP/RTSP protocols, and the like. In alternative embodiments of the present invention, other communications software and transfer protocols may also be used, for example IPX, UDP or the like.

In various embodiments, computer **820** typically includes familiar computer components such as a processor **860**, and memory storage devices, such as a random access memory (RAM) **870**, disk drive **880**, and system bus **890** interconnecting the above components.

In some embodiments, computer **820** includes one or more Xeon™ microprocessors from Intel Corporation. Further, in the present embodiment, computer **820** may include a UNIX-based operating system.

It should be understood that embodiments of the present invention as described above can be implemented in the form of control logic using computer software in a modular or integrated manner. Based on the disclosure and teachings provided herein, a person of ordinary skill in the art will know

and appreciate other ways and/or methods to implement the present invention using hardware and a combination of hardware and software

Any of the software components or functions described in this application, may be implemented as software code to be executed by a processor using any suitable computer language such as, for example, Java, C++ or Perl using, for example, conventional or object-oriented techniques. The software code may be stored as a series of instructions, or commands on a non-transitory computer readable medium, such as a random access memory (RAM), a read only memory (ROM), a magnetic medium such as a hard-drive or a floppy disk, or an optical medium such as a CD-ROM. Any such non-transitory computer readable medium may reside on or within a single computational apparatus, and may be present on or within different computational apparatuses within a system or network.

The above descriptions are illustrative and are not restrictive. Many variations of the invention will become apparent to those skilled in the art upon review of the disclosure. The scope of the invention should, therefore, be determined not with reference to the above description, but instead should be determined with reference to the pending claims along with their full scope or equivalents.

One or more features from any embodiment may be combined with one or more features of any other embodiment without departing from the scope of the invention. For example, any of the above described analytics may be combined with any other suitable analytics in any suitable manner in methods or systems according to embodiments of the invention. Thus, although specific features are separately described in this application, they may be combined in certain embodiments of the invention.

A recitation of “a”, “an” or “the” is intended to mean “one or more” unless specifically indicated to the contrary.

What is claimed is:

1. A method comprising:

receiving, by a tokenization server, a registration request message from a merchant computer;

assigning, by the tokenization server, a merchant verification value and a token derivation key to a merchant associated with the merchant computer;

storing, by the tokenization server, the token derivation key and the merchant verification value in a database;

receiving, by the tokenization server, an authorization request message for a transaction that includes an account identifier and the merchant verification value, wherein the authorization request message is sent by the merchant computer;

sending, by the tokenization server, the authorization request message to an issuer computer for authorization of the transaction;

receiving, by the tokenization server from the issuer computer, an authorization response message indicating whether the transaction has been authorized by the issuer computer;

retrieving, by the tokenization server, the token derivation key using the merchant verification value included in the authorization request message from the database;

generating, by the tokenization server, an account token using the token derivation key by encrypting the account identifier using the token derivation key;

inserting, by the tokenization server, the account token in the authorization response message received from the issuer computer; and

sending, by the tokenization server, the authorization response message including the account token to the

## 31

merchant computer, wherein the token derivation key is available only to the tokenization server.

2. The method of claim 1 wherein a reverse tokenization key usable to generate the account identifier from the account token is stored on the tokenization server.

3. The method of claim 1, further comprising:  
 assigning a token derivation key index to the token derivation key; and  
 inserting the token derivation key index in the authorization response message before the authorization response message is sent to the merchant computer.

4. The method of claim 3, further comprising:  
 assigning a different token derivation key to the merchant associated with the merchant computer; and  
 assigning a different derivation key index to the different token derivation key.

5. The method of claim 3 wherein the token derivation key index is an incremental index.

6. The method of claim 3 wherein the token derivation key index is a hidden index.

7. The method of claim 1, further comprising:  
 generating, by the tokenization server, a reverse tokenization key using the merchant verification value;  
 receiving an account identifier request from the merchant computer, wherein the account identifier request includes the account token;  
 determining, by the tokenization server, the account identifier using the reverse tokenization key and the account token; and  
 sending the account identifier to the merchant computer.

8. The method of claim 1 wherein the account token is generated by applying the account identifier to an encryption or hash function using the token derivation key as a parameter.

9. The method of claim 1 wherein the token derivation key is a key for a symmetric encryption algorithm, and wherein generating the account token further comprises applying the symmetric encryption algorithm to the account identifier.

10. The method of claim 1 wherein the authorization response message includes a bitmap field, and wherein a bit in the bitmap field is set by the tokenization server upon inserting the account token in the authorization response message.

11. The method of claim 1 wherein the authorization response message includes a field tag that identifies a field in the authorization response message containing the account token.

12. The method of claim 1, further comprising:  
 receiving, from a merchant support system server, a normalization request message, wherein the normalization request message includes the merchant verification value and the account token, and wherein the merchant support system server is associated with a merchant support system;  
 generating, by the tokenization server, the account identifier from the account token;  
 selecting a token derivation key assigned to the merchant support system;  
 generating, by the tokenization server, a normalized account token using the token derivation key assigned to the merchant support system; and  
 sending the normalized account token to the merchant support system server.

13. The method of claim 12 wherein the normalization request message further includes a support system verification value that is used to select the token derivation key assigned to the merchant support system.

## 32

14. The method of claim 12 wherein the merchant support system is associated with a fraud scoring service that provides a fraud score for the transaction.

15. The method of claim 12 wherein the merchant support system is associated with an alert service that transmits an alert to a mobile device of an account holder.

16. A server computer comprising:  
 a processor and  
 a non-transitory computer-readable storage medium coupled to the processor, the computer readable storage medium comprising code that, when executed by the processor, causes the processor to perform a method comprising:  
 receiving a registration request message from a merchant computer;  
 assigning a merchant verification value and a token derivation key to a merchant associated with the merchant computer;  
 storing the token derivation key and the merchant verification value in a database;  
 receiving an authorization request message for a transaction that includes an account identifier and the merchant verification value, wherein the authorization request message is sent by the merchant computer;  
 sending the authorization request message to an issuer computer for authorization of the transaction;  
 receiving, from the issuer computer, an authorization response message indicating whether the transaction has been authorized by the issuer computer;  
 retrieving the token derivation key using the merchant verification value included in the authorization request message from the database;  
 generating an account token using the token derivation key by encrypting the account identifier using the token derivation key;  
 inserting the account token in the authorization response message received from the issuer computer; and  
 sending the authorization response message including the account token to the merchant computer, wherein the token derivation key is available only to the server computer.

17. The server computer of claim 16 wherein a reverse tokenization key usable to generate the account identifier from the account token is stored on the server computer.

18. The server computer of claim 16, wherein the method further comprises:  
 assigning a token derivation key index to the token derivation key; and  
 inserting the token derivation key index in the authorization response message before the authorization response message is sent to the merchant computer.

19. The server computer of claim 18, wherein the method further comprises:  
 assigning a different token derivation key to the merchant associated with the merchant computer; and  
 assigning a different derivation key index to the different token derivation key.

20. The method of claim 19, further comprising:  
 determining that the token derivation key has been compromised prior to assigning the different token derivation key to the merchant.

21. A non-transitory computer readable medium storing computer instructions when executed by a processor of a server causes the processor to perform a method comprising:  
 receiving a registration request message from a merchant computer;

assigning a merchant verification value and a token derivation key to a merchant associated with the merchant computer;  
storing the token derivation key and the merchant verification value in a database; 5  
receiving an authorization request message for a transaction that includes an account identifier and the merchant verification value, wherein the authorization request message is sent by the merchant computer;  
sending the authorization request message to an issuer computer for authorization of the transaction; 10  
receiving, from the issuer computer, an authorization response message indicating whether the transaction has been authorized by the issuer computer;  
retrieving the token derivation key using the merchant verification value included in the authorization request message from the database; 15  
generating an account token using the token derivation key by encrypting the account identifier using the token derivation key; 20  
inserting the account token in the authorization response message received from the issuer computer; and  
sending the authorization response message including the account token to the merchant computer, wherein the token derivation key is available only to the server. 25

\* \* \* \* \*

## Electronic Acknowledgement Receipt

<b>EFS ID:</b>	27935472
<b>Application Number:</b>	13740086
<b>International Application Number:</b>	
<b>Confirmation Number:</b>	7081
<b>Title of Invention:</b>	PERSONALIZED DIGITAL MEDIA ACCESS SYSTEM - PDMAS PART II
<b>First Named Inventor/Applicant Name:</b>	William Grecia
<b>Customer Number:</b>	70984
<b>Filer:</b>	William Grecia
<b>Filer Authorized By:</b>	
<b>Attorney Docket Number:</b>	
<b>Receipt Date:</b>	30-DEC-2016
<b>Filing Date:</b>	11-JAN-2013
<b>Time Stamp:</b>	04:14:58
<b>Application Type:</b>	Utility under 35 USC 111(a)

### Payment information:

Submitted with Payment	no
------------------------	----

### File Listing:

Document Number	Document Description	File Name	File Size(Bytes)/ Message Digest	Multi Part /.zip	Pages (if appl.)
1	Miscellaneous Incoming Letter	juniorart.pdf	17846  0b4b771fdc9c8d1f9675a5c91070fa3bbbd20ae9	no	1

### Warnings:

EWS-003500

Information:					
2	Miscellaneous Incoming Letter	pat9519802.pdf	1192752	no	14
			ce119b8b9f895736fac1b88e746c53f3332c831		
Warnings:					
Information:					
3	Miscellaneous Incoming Letter	pat9342832.pdf	2341122	no	31
			b03e53d2e9bb8c1a15a33f4135a880d8ef807f77		
Warnings:					
Information:					
<b>Total Files Size (in bytes):</b>				3551720	
<p><b>This Acknowledgement Receipt evidences receipt on the noted date by the USPTO of the indicated documents, characterized by the applicant, and including page counts, where applicable. It serves as evidence of receipt similar to a Post Card, as described in MPEP 503.</b></p> <p><b><u>New Applications Under 35 U.S.C. 111</u></b>  <b>If a new application is being filed and the application includes the necessary components for a filing date (see 37 CFR 1.53(b)-(d) and MPEP 506), a Filing Receipt (37 CFR 1.54) will be issued in due course and the date shown on this Acknowledgement Receipt will establish the filing date of the application.</b></p> <p><b><u>National Stage of an International Application under 35 U.S.C. 371</u></b>  <b>If a timely submission to enter the national stage of an international application is compliant with the conditions of 35 U.S.C. 371 and other applicable requirements a Form PCT/DO/EO/903 indicating acceptance of the application as a national stage submission under 35 U.S.C. 371 will be issued in addition to the Filing Receipt, in due course.</b></p> <p><b><u>New International Application Filed with the USPTO as a Receiving Office</u></b>  <b>If a new international application is being filed and the international application includes the necessary components for an international filing date (see PCT Article 11 and MPEP 1810), a Notification of the International Application Number and of the International Filing Date (Form PCT/RO/105) will be issued in due course, subject to prescriptions concerning national security, and the date shown on this Acknowledgement Receipt will establish the international filing date of the application.</b></p>					

AO 120 (Rev. 08/10)

TO: <b>Mail Stop 8</b> <b>Director of the U.S. Patent and Trademark Office</b> <b>P.O. Box 1450</b> <b>Alexandria, VA 22313-1450</b>	<b>REPORT ON THE</b> <b>FILING OR DETERMINATION OF AN</b> <b>ACTION REGARDING A PATENT OR</b> <b>TRADEMARK</b>
---	---

In Compliance with 35 U.S.C. § 290 and/or 15 U.S.C. § 1116 you are hereby advised that a court action has been filed in the U.S. District Court \_\_\_\_\_ on the following

Trademarks or  Patents. (  the patent action involves 35 U.S.C. § 292.);

DOCKET NO. 1:16-cv-7022	DATE FILED 9/8/2016	U.S. DISTRICT COURT
PLAINTIFF WILLIAM GRECIA		DEFENDANT 1-800-FLOWERS.COM, INC.
PATENT OR TRADEMARK NO.	DATE OF PATENT OR TRADEMARK	HOLDER OF PATENT OR TRADEMARK
1 8,533,860	9/10/2013	WILLIAM GRECIA
2		
3		
4		
5		

In the above—entitled case, the following patent(s)/ trademark(s) have been included:

DATE INCLUDED	INCLUDED BY
	<input checked="" type="radio"/> Amendment <input checked="" type="radio"/> Answer <input checked="" type="radio"/> Cross Bill <input checked="" type="radio"/> Other Pleading
TRADEMARK NO.	DATE OF PATENT OR TRADEMARK
1	
2	
3	
4	
5	

In the above—entitled case, the following decision has been rendered or judgement issued:

DECISION/JUDGEMENT
--------------------

CLERK Ruby J. Krajick	(BY) DEPUTY CLERK R. Chambers	DATE 9/9/2016
--------------------------	----------------------------------	------------------

Copy 1—Upon initiation of action, mail this copy to Director    Copy 3—Upon termination of action, mail this copy to Director  
 Copy 2—Upon filing document adding patent(s), mail this copy to Director    Copy 4—Case file copy



AO 120 (Rev. 08/10)

TO: <b>Mail Stop 8</b> <b>Director of the U.S. Patent and Trademark Office</b> <b>P.O. Box 1450</b> <b>Alexandria, VA 22313-1450</b>	<b>REPORT ON THE</b> <b>FILING OR DETERMINATION OF AN</b> <b>ACTION REGARDING A PATENT OR</b> <b>TRADEMARK</b>
---	---

In Compliance with 35 U.S.C. § 290 and/or 15 U.S.C. § 1116 you are hereby advised that a court action has been filed in the U.S. District Court Southern District of New York on the following

Trademarks or  Patents. (  the patent action involves 35 U.S.C. § 292.);

DOCKET NO. 1:16-cv-7024	DATE FILED 9/8/2016	U.S. DISTRICT COURT Southern District of New York
PLAINTIFF WILLIAM GRECIA		DEFENDANT BESTBUY.COM, LLC
PATENT OR TRADEMARK NO.	DATE OF PATENT OR TRADEMARK	HOLDER OF PATENT OR TRADEMARK
1 8,533,860	9/10/2013	WILLIAM GRECIA
2		
3		
4		
5		

In the above—entitled case, the following patent(s)/ trademark(s) have been included:

DATE INCLUDED	INCLUDED BY <input checked="" type="radio"/> Amendment <input checked="" type="radio"/> Answer <input checked="" type="radio"/> Cross Bill <input checked="" type="radio"/> Other Pleading		
TRADEMARK NO.	DATE OF PATENT OR TRADEMARK	HOLDER OF PATENT OR TRADEMARK	
1			
2			
3			
4			
5			

In the above—entitled case, the following decision has been rendered or judgement issued:

DECISION/JUDGEMENT
--------------------

CLERK Ruby J. Krajick	(BY) DEPUTY CLERK /s/ P. Canales	DATE 9/9/2016
--------------------------	-------------------------------------	------------------

Copy 1—Upon initiation of action, mail this copy to Director Copy 3—Upon termination of action, mail this copy to Director  
 Copy 2—Upon filing document adding patent(s), mail this copy to Director Copy 4—Case file copy



UNITED STATES PATENT AND TRADEMARK OFFICE

UNITED STATES DEPARTMENT OF COMMERCE
United States Patent and Trademark Office
Address: COMMISSIONER FOR PATENTS
P.O. Box 1450
Alexandria, Virginia 22313-1450
www.uspto.gov

Table with 5 columns: APPLICATION NUMBER, FILING OR 371(C) DATE, FIRST NAMED APPLICANT, ATTY.DOCKET NO./TITLE, REQUEST ID. Values: 13/740,086, 01/11/2013, William Grecia, [blank], 24776

Acknowledgement of Loss of Entitlement to Entity Status Discount

The entity status change request below filed through Private PAIR on 09/10/2016 has been accepted.

CERTIFICATIONS:

Change of Entity Status:
X Applicant changing to regular undiscounted fee status.
NOTE: Checking this box will be taken to be notification of loss of entitlement to small or micro entity status, as applicable.

This portion must be completed by the signatory or signatories making the entity status change in accordance with 37 CFR 1.4(d)(4).

Table with 2 columns: Label, Value. Rows: Signature: /william grecia/, Name: William Grecia, Registration Number: -

UNITED STATES PATENT AND TRADEMARK OFFICE

---

BEFORE THE PATENT TRIAL AND APPEAL BOARD

---

UNIFIED PATENTS INC.,  
Petitioner,

v.

WILLIAM GRECIA,  
Patent Owner.

---

Case IPR2016-00600  
Patent 8,533,860 B1

---

Before GLENN J. PERRY, RAMA G. ELLURU, and  
MICHELLE N. WORMMEESTER, *Administrative Patent Judges*.

WORMMEESTER, *Administrative Patent Judge*.

DECISION  
Denying Institution of *Inter Partes* Review  
37 C.F.R. § 42.108

Unified Patents Inc. (“Petitioner”) filed a Corrected Petition (Paper 7, “Pet.”) requesting *inter partes* review of claims 1–30 of U.S. Patent No. 8,533,860 B1 (Ex. 1001, “the ’860 patent”). William Grecia (“Patent Owner”) filed a Preliminary Response (Paper 10, “Prelim. Resp.”). We have jurisdiction under 35 U.S.C. § 314(a), which provides that an *inter partes* review may not be instituted “unless . . . there is a reasonable likelihood that the petitioner would prevail with respect to at least 1 of the claims challenged in the petition.” For the reasons that follow, we have decided not to institute an *inter partes* review.

## I. BACKGROUND

### A. The ’860 Patent

The ’860 patent is titled “Personalized Digital Media Access System—PDMAS Part II.” Ex. 1001, at [54]. The ’860 patent describes a digital rights management system that manages access rights across a plurality of devices via digital media personalization to protect digital media subject to illegal copying. *Id.* at 1:19–26; 4:47–48.

The system includes a first receipt module, an authentication module, a connection module, a request module, a second receipt module, and a branding module. *See id.* at Fig. 1. The first receipt module receives a branding request from a user’s (content acquirer’s) device. *Id.* at 5:45–47. The branding request is a read and write request of metadata of the digital media and includes a membership verification token corresponding to the digital media. *Id.* at 5:47–50. The authentication module authenticates the membership verification token. *Id.* at 5:56–57. The connection module establishes communication with the user’s device. *Id.* at 5:58–60. The

request module requests an electronic identification reference from the user's device. *Id.* at 6:4–6. The second receipt module receives the electronic identification reference. *Id.* at 6:6–8. The branding module brands metadata of the digital media by writing the membership verification token and the electronic identification into the metadata. *Id.* at 6:8–11.

Figure 3, which is reproduced below, illustrates this process.

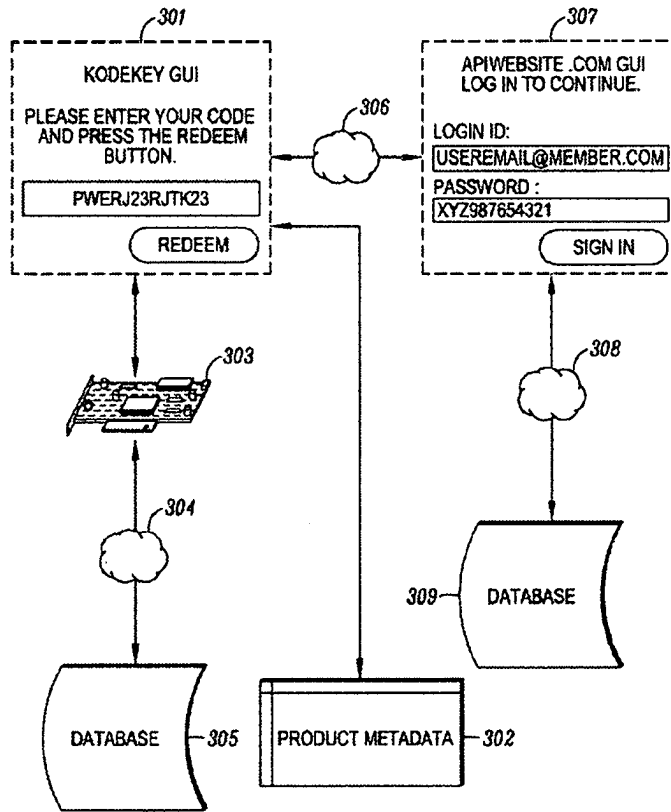

FIG. 3

In particular, Figure 3 is a flow chart of the process of digital media personalization. *Id.* at 4:23–25. A user posts a branding request via Kodekey GUI 301, which prompts the user to enter a token and press the redeem button. *Id.* at 6:65–67, 7:1–3. Product metadata 302 is associated with the digital media to be acquired. *Id.* at 7:3–4. The Kodekey GUI is

connected to token database 305. The user is then redirected to APIwebsite.com GUI 307, which prompts the user to enter a login id and password to access the digital media from database 309. *Id.* at 7:10–11, 14–17. The APIwebsite.com GUI interfaces to a web service membership, where the user’s electronic identification is collected and sent back to the Kodekey GUI. *Id.* at 7:10–14. The database containing the digital media is connected to the web service membership. *Id.* at 7:17–19.

*B. Illustrative Claim*

Petitioner challenges claims 1–30 of the ’860 patent. Claims 1, 9, 11, and 21 are independent. Claim 1 is illustrative of the claims under challenge:

1. A method for authorizing access to digital content using a cloud system, the cloud system comprising connected modules in operation as one or more of a cloud computing or a cloud storage in connection with devices and users, wherein the digital content is at least one of encrypted or not encrypted, the method facilitating access rights between a plurality of data processing devices, the method comprising:

receiving a digital content access request from at least one communications console of the plurality of data processing devices, the access request being a read or write request of metadata of the digital content, wherein the read or write request of metadata is performed in connection with a combination of at least one device and the cloud system, the request comprising a verification token provided by a first user corresponding to the digital content, wherein the verification token is one or more of a password, e-mail address, payment system, credit card, authorize ready device, rights token, or one or more redeemable instruments of trade;

authenticating the verification token;

establishing a connection with the at least one communications console, wherein the communications console is a combination of a graphic user interface (GUI) and an Application Programmable Interface (API) wherein the API is related to a verified web service, the web service capable of facilitating a two way data exchange session to complete a verification process wherein the data exchange session comprises at least one identification reference;

requesting the at least one identification reference from the at least one communications console, wherein the identification reference comprises one or more of a verified web service account identifier, letter, number, rights token, e-mail, password, access time, serial number, address, manufacturer identification, checksum, operating system version, browser version, credential, cookie, or key;

receiving the at least one identification reference from the at least one communications console; and

writing at least one of the verification token or the identification reference into the metadata.

### *C. Asserted Grounds of Unpatentability*

Petitioner challenges claims 1–30 of the '860 patent on the following grounds.<sup>1</sup> Pet. 4, 15–59.

---

<sup>1</sup> In summarizing its asserted grounds on page 4 of the Petition, Petitioner requests cancellation of claims 1–30 as unpatentable under 35 U.S.C § 103 based on “[t]wo main references,” but states on page 15 of the Petition that the same references “anticipate and/or render obvious the claimed subject matter.” Given the substance of Petitioner’s arguments, we address claims 1–30 under 35 U.S.C. §§ 102 and 103.

Reference(s)	Basis	Claims Challenged
DeMello <sup>2</sup>	§ 102	1–30
DeMello and “the admitted prior art”	§ 103	1–20
Pestoni <sup>3</sup>	§ 102	1–30
Pestoni and “the admitted prior art”	§ 103	1–20
DeMello and Wiser <sup>4</sup>	§ 103	21–30
Pestoni and Wiser	§ 103	21–30
DeMello, Wiser, and Cooper <sup>5</sup>	§ 103	17 and 30

In support of its arguments, Petitioner proffers the declaration of Ravi S. Cherukuri (Ex. 1010). *See id.*

#### *D. Claim Construction*

We construe claims in an unexpired patent by applying the broadest reasonable interpretation in light of the specification of the patent in which they appear. *See* 37 C.F.R. § 42.100(b); *In re Cuozzo Speed Techs., LLC*, 793 F.3d 1268, 1278 (Fed. Cir. 2015) (“We conclude that Congress implicitly approved the broadest reasonable interpretation standard in enacting the AIA.”), *aff’d sub nom. Cuozzo Speed Techs., LLC v. Lee*, 136 S. Ct. 2131 (2016). Under this standard, claim terms are given their ordinary and customary meaning, as would be understood by one of ordinary skill in the art in the context of the entire disclosure. *See In re Translogic Tech., Inc.*, 504 F.3d 1249, 1257 (Fed. Cir. 2007). A “claim term will not receive its ordinary meaning if the patentee acted as his own lexicographer,”

---

<sup>2</sup> DeMello, U.S. Patent No. 6,891,953 B1, issued May 10, 2005 (Ex. 1006).

<sup>3</sup> Pestoni, U.S. Publ’n No. US 2008/0313264 A1, published Dec. 18, 2008 (Ex. 1007).

<sup>4</sup> Wiser, U.S. Patent No. 6,385,596 B1, issued May 7, 2002 (Ex. 1008).

<sup>5</sup> Cooper, U.S. Publ’n No. US 2009/0037388 A1, published Feb. 5, 2009 (Ex. 1009).



however, and clearly set forth a definition of the claim term in the specification. *CCS Fitness, Inc. v. Brunswick Corp.*, 288 F.3d 1359, 1366 (Fed. Cir. 2002).

Petitioner provides proposed interpretations for various limitations of the claims. *See* Pet. 12–14. Patent Owner does not respond, except for asserting that “[t]he Petition and the Declaration have different constructions of ‘verified web service.’” Prelim. Resp. 5. For purposes of this Decision, we conclude that no term requires interpretation at this time to resolve a controversy in this proceeding. *See Vivid Techs., Inc. v. Am. Sci. & Eng’g, Inc.*, 200 F.3d 795, 803 (Fed. Cir. 1999) (“only those terms need be construed that are in controversy, and only to the extent necessary to resolve the controversy”).

## II. DISCUSSION

### *A. Anticipation by DeMello*

Petitioner argues that DeMello anticipates claims 1–30 of the ’860 patent. *See* Pet. 15–28, 49–58. For the reasons explained below, we are not persuaded that Petitioner has demonstrated a reasonable likelihood of prevailing on its asserted ground.

#### *1. DeMello*

DeMello describes a digital rights management system that distributes and protects rights in content, such as electronic books (eBooks). Ex. 1006, at [57], 4:43–45. As shown in Figure 4, which is reproduced below, the system includes a retail site, a fulfillment site, and an activation site.

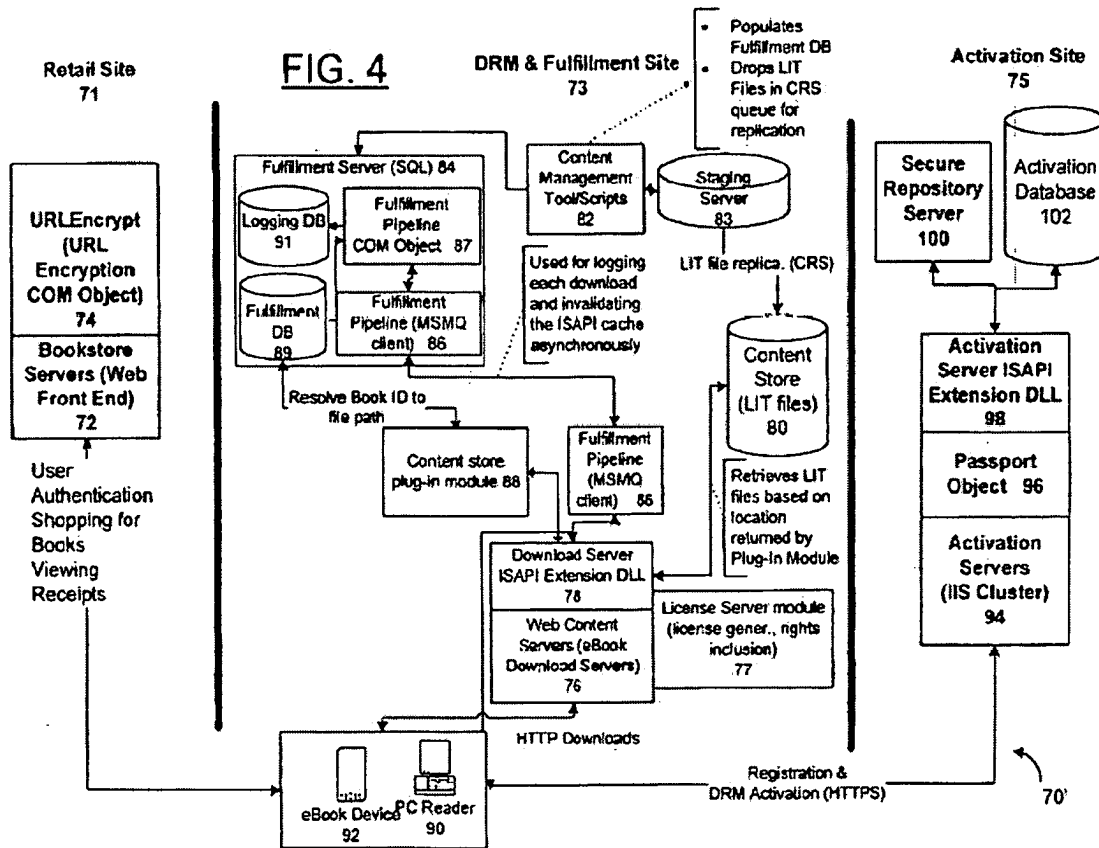

Figure 4 is a block diagram of one embodiment of the digital rights management system. *Id.* at 4:19–21. The retail site sells eBooks to consumers, the fulfillment site provides the sold eBooks to the consumers, and the activation site enables consumer reading devices to use eBooks with enhanced levels of copy protection (e.g., eBooks requiring licenses). *Id.* at [57], 6:10–16, 21:36–37.

In order to access an eBook, a consumer begins by choosing a title from the retail site and paying for the title. *Id.* at 26:1–4. The retail site then issues a receipt page with a link for downloading the title. *Id.* at 26:4–7. When the consumer clicks on the link, a download server at the fulfillment site adds the consumer’s name to the title metadata. *Id.* at 26:15–23, Fig. 4. The title is then downloaded to the consumer’s device, and the eBook is

opened to its cover page with the rightful owner's name appearing under the author's name. *Id.* at 26:35–36, 27:45–46.

## 2. Analysis

Independent claims 1, 9, 11, and 21 recite a request comprising a verification token corresponding to digital content. For this limitation, Petitioner identifies the communication between a bookstore server 72 and a user as a “request.” Pet. 20. Petitioner further argues that “*DeMello* teaches ‘user authentication’ and establishing a membership relationship with a retailer (left of Figure 4), which inherently would include providing a token, such as a retailer password and/or email (e.g., Amazon log-on credentials).” Pet. 18; *see also id.* at 16 (“authentication credentials (e.g., Amazon.com log-on credentials), which is a verification token”), 20 (“**establish their membership relationship with the retailer** [verification token]”).

Based on the record presented, we are unpersuaded by this argument. As Patent Owner points out, the “claims require a verification token ‘corresponding to the digital content.’” Prelim. Resp. 29. Petitioner does not provide persuasive explanation as to how a *retailer* password or e-mail corresponds to *digital content*. In fact, Petitioner does not appear to address this recited feature at all. *See* 35 U.S.C. §312(a)(3) (a petition must identify, “with particularity, each claim challenged, the grounds on which the challenge to each claim is based, and the evidence that supports the grounds for the challenge to each claim”); 37 C.F.R. § 42.104(b) (a petition must identify “[h]ow the construed claim is unpatentable under the statutory grounds identified” and “where each element of the claim is found in the prior art,” and must explain the “relevance of the evidence to the challenge

raised”); 37 C.F.R. § 42.22(a)(2) (a petition must include a “full statement of the reasons for the relief requested, including a detailed explanation of the significance of the evidence”). As Petitioner does not identify specifically how a retailer password or e-mail in DeMello corresponds to digital content, we are not persuaded that Petitioner has made a sufficient showing that DeMello discloses the recited verification token.

Petitioner further argues that “[o]ther embodiments” in DeMello describe various options that satisfy the recited “verification token,” as “set forth in the Cherukuri Declaration (EX1010) at Ex. C, such as the BookID.” Pet. 19 (emphasis omitted). We are unpersuaded by this argument as well. First, we note that Mr. Cherukuri does not discuss the BookID in Exhibit C of his declaration, and Petitioner provides no further citation or sufficient explanation as to how the BookID satisfies the recited “verification token.” We also note that DeMello describes the BookID as being “used by download server 76 to locate the proper LIT file via content store plug-in module 88 (which looks-up the BookID in fulfillment database 84).” Ex. 1006, 16:5–8. As discussed above, however, Petitioner identifies the user’s communication with the bookstore server 72 (not the download server 76) as the “request” comprising the “verification token.” *See In re Arkley*, 455 F.2d 586, 587 (CCPA 1972) (“The [prior art] reference must clearly and unequivocally disclose the claimed [invention] or direct those skilled in the art to the [invention] without *any* need for picking, choosing, and combining various disclosures not directly related to each other by the teachings of the cited reference.”); *Net MoneyIN, Inc. v. VeriSign, Inc.*, 545 F.3d 1359, 1369–70 (Fed. Cir. 2008) (“the prior art reference—in order to anticipate under 35 U.S.C. § 102—must not only disclose all elements of the

claim within the four corners of the document, but must also disclose those elements ‘arranged as in the claim.’”).

Second, while Mr. Cherukuri discusses other alternatives in DeMello as satisfying the recited “verification token” (*see* Ex. 1010, at Ex. C (claim element 1[B])), Petitioner’s reliance on such discussion is an improper incorporation by reference of arguments asserted in a declaration, which we will not consider here. *See* 37 C.F.R. § 42.6(a)(3) (“Arguments must not be incorporated by reference from one document into another document.”).

Finally, Petitioner argues that the following items in DeMello also satisfy the recited “verification token”: “the username and other credentials,” the purchaser credit card, the purchaser name, and the PASSPORT ID. Pet. 20, 27. Again, Petitioner does not explain persuasively how any of these items corresponds to digital content.

In view of the foregoing, we determine that Petitioner has not demonstrated a reasonable likelihood of prevailing in showing that DeMello anticipates independent claims 1, 9, 11, and 21. *See also* Pet. 42 (referring to analysis of claim 1 for claim 9), 44–45 (referring to analysis of claim 1 for claim 11), 52–53 (referring to analyses of claims 1 and 11 for claim 21). Claims 2–8, 10, 12–20, and 22–30 depend from claims 1, 9, 11, or 21. Accordingly, we also determine that Petitioner has not demonstrated a reasonable likelihood of prevailing in showing that DeMello anticipates these dependent claims.

*B. Obviousness over DeMello and the Admitted Prior Art*

Petitioner argues that claims 1–20 of the ’860 patent would have been obvious over DeMello and “the admitted prior art.” *See* Pet. 15–28. For the

reasons explained below, we are not persuaded that Petitioner has demonstrated a reasonable likelihood of prevailing on its asserted ground.

Independent claim 1 recites limitations including: a first “receiving” step, which Petitioner designates as element [B]; an “authenticating” step, which Petitioner designates as element [C]; an “establishing” step, which Petitioner designates as element [D]; and a “writing” step, which Petitioner designates as element [G]. *See* Pet. 17–24, 26–28. Independent claims 9 and 11 recite similar limitations. According to Petitioner, Patent Owner admits that elements [B], [C], and [G], as well as the “GUI” of element [D] are a part of the prior art. Pet. 18 (citing Ex. 1005, at 14), 21–22 (citing Ex. 1003, 10:41–51), 26–27 (citing Ex. 1005, at 13). As support, Petitioner relies on statements made in Patent Owner’s Preliminary Response in IPR2015-0422, which also involves the ’860 patent, as well as the specification of U.S. Patent No. 8,887,308, which is related to the ’860 patent. *See id.*

It is not sufficient, however, for Petitioner to demonstrate that each of the claim elements is known. *See KSR Int’l Co. v. Teleflex Inc.*, 550 U.S. 398, 418 (2007). Petitioner must also provide “some articulated reasoning with some rational underpinning to support the legal conclusion of obviousness.” *In re Kahn*, 441 F.3d 977, 988 (Fed. Cir. 2006).

In that regard, with respect to element [B], Petitioner argues:

*DeMello* teaches “user authentication” and establishing a membership relationship with a retailer (left of Figure 4), which inherently would include providing a token, such as a retailer password and/or email (e.g., Amazon log-on credentials). User authentication and establishing a membership are obvious in view of the admitted prior art. The admitted prior art steps are described in the parent ‘555 Patent as verifying membership for

site to buy content, and *DeMello* recites establishing such a membership relationship. It would be obvious to use the verification token of the admitted prior art to establish a membership relationship.

Pet. 18–19. Petitioner does not, however, explain sufficiently *why* one of ordinary skill in the art would have considered combining DeMello and any other patent or printed publication to arrive at the claimed invention. For example, Petitioner does not explain persuasively why one of ordinary skill in the art would have considered “us[ing] the verification token of the admitted prior art to establish a membership relationship” in DeMello, when DeMello already teaches “establishing a membership relationship with a retailer.” *See id.*

With respect to elements [C] and [G], Petitioner does not appear to proffer any reason for combining DeMello and the admitted prior art. *See* Pet. 20–21, 26–28.

Finally, with respect to element [D], Petitioner merely asserts that “it is obvious that the browser of the reader mentioned in *DeMello* includes a GUI, since browsers provide a GUI.” *Id.* at 23. Again, Petitioner does not explain sufficiently *why* one of ordinary skill in the art would have considered combining DeMello and any other patent or printed publication to arrive at the claimed invention.

Based on the record presented, we are not persuaded that Petitioner has provided adequately articulated reasoning with some rational underpinning to support the legal conclusion of obviousness with respect to elements [B], [C], [D], and [G]. *See Kahn*, 441 F.3d at 988. Accordingly, we determine that Petitioner has not demonstrated a reasonable likelihood of prevailing in showing that claims 1, 9, and 11 would have been obvious over

DeMello and the admitted prior art. *See also* Pet. 42 (referring to analysis of claim 1 for claim 9), 44–45 (referring to analysis of claim 1 for claim 11). Claims 2–8, 10, and 12–20 depend from claims 1, 9, or 11. We therefore also determine that Petitioner has not demonstrated a reasonable likelihood of prevailing in showing that these dependent claims would have been obvious over DeMello and the admitted prior art.

### *C. Anticipation by Pestoni*

Petitioner argues that Pestoni anticipates claims 1–30 of the '860 patent. *See* Pet. 15, 28–58. For the reasons explained below, we are not persuaded that Petitioner has demonstrated a reasonable likelihood of prevailing on its asserted ground.

#### *1. Pestoni*

Pestoni describes a system with domain management for digital media. Ex. 1007, at [57]. As shown in Figure 1, which is reproduced below, the system includes a domain administrator, a content provider, and a license server.



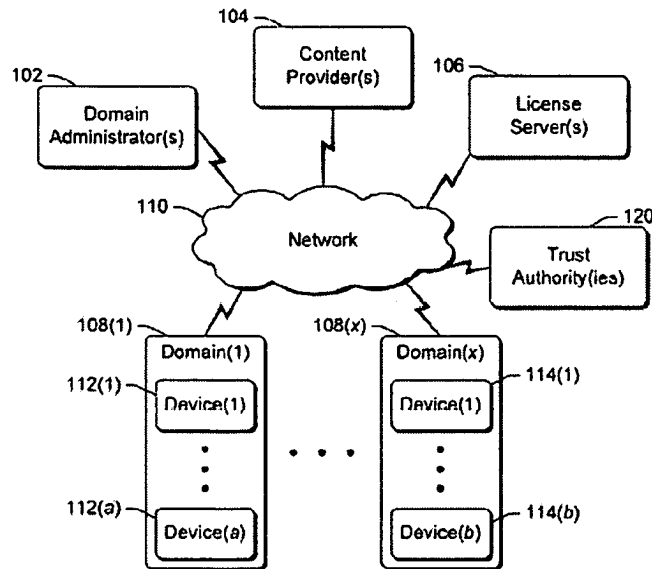

**Fig. 1**

Figure 1 illustrates one embodiment of a system that employs domain management for digital media. *Id.* ¶ 6. Media playback device 112 or 114 may obtain content from content provider 104 by submitting a content request to the content provider. *Id.* ¶ 67. In order to access and play back the content, the device must have a domain membership license from domain administrator 102 and a content license from license server 106. *Id.* ¶ 17.

To obtain a domain membership license, the device submits a join-domain request to the domain administrator. *Id.* ¶ 38. The request includes parameters to identify the device, such as a device certificate, user credentials, and a device description. *Id.* ¶ 39. If the domain administrator approves the request, the device becomes a member of the domain and receives a domain membership license. *Id.* ¶¶ 38, 44.

To obtain a content license, the device submits a content license request to the license server. *Id.* ¶¶ 69, 72. The request includes parameters, such as a key ID, a domain ID, and a domain certificate, to identify both the content for which the license is being requested and the domain of which the device is a member. *Id.* ¶ 72. In response to the request, the license server validates the domain certificate, and, if successful, approves the request. *Id.* ¶¶ 75, 79. Once the request is approved, the license server generates a content license, binds the license to the domain identified in the request, and provides the device with the license. *Id.* ¶¶ 79–80, 82, 84.

## 2. Analysis

As an initial matter, we note that Petitioner argues that the asserted references “anticipate and/or render obvious the claimed subject matter, and are corroborated by the opinion in the Cherukuri Declaration.” Pet. 15. Petitioner does not set forth its entire anticipation analysis in the Petition, however, relying instead on Mr. Cherukuri’s declaration testimony to set forth portions of the analysis. For example, claim 1 recites a “GUI” and an “API . . . related to a verified web service.” Without addressing in the Petition whether Pestoni discloses these claim elements, Petitioner directs us to Mr. Cherukuri’s declaration testimony regarding the same claim elements. *Id.* at 31 (citing Ex. 1010 ¶ 80, Exhibit D). That testimony includes a statement that “it is inherent that a user would use a GUI,” as well as a statement that “it is inherent that the device uses the API . . . [and] that the API is related to a web service.” Ex. 1010 ¶ 80, Exhibit D. Such reliance on Mr. Cherukuri’s declaration testimony is an improper incorporation by

reference of arguments asserted in a declaration. *See* 37 C.F.R. § 42.6(a)(3). Petitioner's asserted ground fails for this reason.

Even if the testimony had been fully described in the Petition, the anticipation argument with respect to Pestoni would still fail. As discussed above, claims 1, 9, 11, and 21 recite a request comprising a verification token corresponding to digital content. For this limitation, Petitioner points to Pestoni's disclosure of a content request and a join-domain request. Pet. 30 (citing Ex. 1007 ¶¶ 44, 67). Petitioner also directs us to where Pestoni discloses that "content can be obtained . . . concurrently with joining a domain." *Id.* (citing Ex. ¶ 67). Petitioner appears to identify the content request and join-domain request together as the recited "request." *See* Pet. 30 ("[d]evice 202 **communicates** with content provider 104 **to obtain** pieces of protected **content** [content access request]" and "[d]omain request approval module 224 . . . **receives join-domain request 220**"). Petitioner further identifies the user credentials included in Pestoni's join-domain request as the recited "verification token." *Id.* (citing Ex. 1007 ¶¶ 39, 41). As Petitioner highlights, the user credentials may include a user id and password. *Id.* at 29–30 ("**user credentials** can take any of a variety of different forms, such as a **user id and password**").

Based on the record presented, we are unpersuaded by Petitioner's argument. As discussed above, Patent Owner points out that the "claims require a verification token 'corresponding to the digital content.'" Prelim. Resp. 29. We note that Pestoni discloses that the user id and password are "credentials that identify the user." Ex. 1007 ¶ 41. In light of this disclosure, Petitioner does not provide persuasive explanation as to how a *user* id or password corresponds to *digital content*. In fact, Petitioner does

not appear to address this recited feature at all. *See* 35 U.S.C. § 312(a)(3); 37 C.F.R. § 42.104(b); 37 C.F.R. § 42.22(a)(2). As Petitioner does not identify specifically how a user id or password in Pestoni corresponds to digital content, we are not persuaded that Petitioner has made a sufficient showing that Pestoni discloses the recited verification token.

Referring to “[o]ther embodiments” in Pestoni, Petitioner further argues that the “‘verification token’ is also shown by . . . a digital certificate and other parameters in *Pestoni*, . . . as set forth in the Cherukuri Declaration (EX1010) at Ex. D, Element G.” Pet. 35 (emphasis omitted).

On this record, we are unpersuaded by Petitioner’s argument in this regard. Although the digital certificate in Pestoni is also an example of user credentials included in the join-domain request, we note that the digital certificate “attest[s] to the *user’s* identity and [is] digitally signed by a *trust authority*.” Ex. 1007 ¶ 41 (emphasis added). As with the user id and password discussed above, Petitioner does not explain persuasively how the digital certificate corresponds to *digital content*.

Moreover, while Mr. Cherukuri may discuss other alternatives in Pestoni as satisfying the recited “verification token,” Petitioner’s reliance on such discussion is an improper incorporation by reference of arguments asserted in a declaration, which we will not consider here. *See* 37 C.F.R. § 42.6(a)(3).

In view of the foregoing, we determine that Petitioner has not demonstrated a reasonable likelihood of prevailing in showing that Pestoni anticipates independent claims 1, 9, 11, and 21. *See also* Pet. 42 (referring to analysis of claim 1 for claim 9), 44–45 (referring to analysis of claim 1 for claim 11), 52–53 (referring to analyses of claims 1 and 11 for claim 21).

Claims 2–8, 10, 12–20, and 22–30 depend from claims 1, 9, 11, or 21. Accordingly, we also determine that Petitioner has not demonstrated a reasonable likelihood of prevailing in showing that Pestoni anticipates these dependent claims.

*D. Obviousness over Pestoni and the Admitted Prior Art*

Petitioner argues that claims 1–20 of the '860 patent would have been obvious over Pestoni and “the admitted prior art.” *See* Pet. 15, 28–48. For the reasons explained below, we are not persuaded that Petitioner has demonstrated a reasonable likelihood of prevailing on its asserted ground.

As discussed above, independent claim 1 recites several limitations, which Petitioner designates as elements [B], [C], [D], and [G]. Independent claims 9 and 11 recite similar limitations. According to Petitioner, Patent Owner admits that elements [B], [C], and [G], as well as the “GUI” of element [D] are a part of the prior art. *Id.* at 29 (citing Ex. 1005, at 6), 30, 32, 34. As support, Petitioner relies on statements made in Patent Owner’s Preliminary Response in IPR2015-0422, which also involves the '860 patent. *See id.; see also id.* at 18 (citing Ex. 1005, at 14).

Again, it is not sufficient for Petitioner to demonstrate that each of the claim elements is known. *See KSR*, 550 U.S. at 418. Petitioner must also provide “some articulated reasoning with some rational underpinning to support the legal conclusion of obviousness.” *Kahn*, 441 F.3d at 988. In that regard, Petitioner does not appear to proffer any reason for combining Pestoni and any other patent or printed publication to arrive at the claimed invention. *See* Pet. 29–32, 34–35. Accordingly, on this record, we are not persuaded that Petitioner has provided adequately articulated reasoning with

some rational underpinning to support the legal conclusion of obviousness. *See Kahn*, 441 F.3d at 988.

In view of the foregoing, we determine that Petitioner has not demonstrated a reasonable likelihood of prevailing in showing that claims 1, 9, and 11 would have been obvious based on the combination of Pestoni and the admitted prior art. *See also* Pet. 42 (referring to analysis of claim 1 for claim 9), 44–45 (referring to analysis of claim 1 for claim 11). Claims 2–8, 10, and 12–20 depend from claims 1, 9, or 11. Accordingly, we also determine that Petitioner has not demonstrated a reasonable likelihood of prevailing in showing that these dependent claims would have been obvious based on the combination of Pestoni and the admitted prior art.

*E. Obviousness over DeMello and Wiser or over Pestoni and Wiser*

Petitioner argues that claims 21–30 of the '860 patent would have been obvious over DeMello and Wiser or over Pestoni and Wiser. *See* Pet. 48–58. Claim 21 recites a “request comprising a verification token corresponding to the digital content.” For the reasons discussed *supra*, Petitioner’s arguments and evidence regarding claim 21 do not remedy the deficiencies discussed above with respect to claims 1, 9, 11, and 21. *See id.* at 52–53 (referring to analyses of claims 1 and 11 for claim 21). Accordingly, on this record, we determine that Petitioner has not demonstrated a reasonable likelihood of prevailing on its assertion that claim 21 would have been obvious over DeMello and Wiser or over Pestoni and Wiser. As claims 22–30 depend from claim 21, we also determine that Petitioner has not demonstrated a reasonable likelihood of prevailing on its

assertion that these dependent claims would have been obvious over DeMello and Wiser or over Pestoni and Wiser.

*F. Obviousness over DeMello, Wiser, and Cooper*

Petitioner argues that claims 17 and 30 of the '860 patent would have been obvious over DeMello, Wiser, and Cooper. Pet. 58–59. Claims 17 and 30 depend from claims 11 and 21, respectively. Petitioner's arguments and evidence regarding claims 17 and 30 do not remedy the deficiencies discussed above with respect to claims 11 and 21. *See id.* On this record, and for the reasons discussed *supra*, we determine that Petitioner has not demonstrated a reasonable likelihood of prevailing on its assertion that claims 17 and 30 would have been obvious over DeMello, Wiser, and Cooper.

*G. 35 U.S.C. § 315(b)*

Patent Owner proffers arguments asserting that the Petition is time-barred under 35 U.S.C. § 315(b) because “[Patent Owner] filed and served a complaint alleging that Google infringed the ‘860 patent” and “Google, an original founding member of [Petitioner] and continuing customer of [Petitioner] (Ex. 2005), is a privy of [Petitioner].” Prelim. Resp. 41–42.

Because the information presented in the Petition does not demonstrate a reasonable likelihood that Petitioner would prevail with respect to at least one of the challenged claims, we need not address Patent Owner's assertions that the Petition is time-barred under 35 U.S.C. § 315(b) based on privity.

IPR2016-00600  
Patent 8,533,860 B1

### III. CONCLUSION

For the foregoing reasons, we are not persuaded that Petitioner has demonstrated a reasonable likelihood that it would prevail with respect to any of the challenged claims of the '860 patent.

### IV. ORDER

For the reasons given, it is

ORDERED that the Petition is *denied* as to all challenged claims, and no trial is instituted.

#### PETITIONER:

Paul C. Haughey  
[phaughey@kilpatricktownsend.com](mailto:phaughey@kilpatricktownsend.com)

Scott E. Kolassa  
[SKolassa@kilpatricktownsend.com](mailto:SKolassa@kilpatricktownsend.com)

Jonathan Stroud  
[jonathan@unifiedpatents.com](mailto:jonathan@unifiedpatents.com)

Kevin Jakel  
[kevin@unifiedpatents.com](mailto:kevin@unifiedpatents.com)

#### PATENT OWNER:

Patrick Richards  
[patrick@richardspatentlaw.com](mailto:patrick@richardspatentlaw.com)

Clare Frederick  
[clare@richardspatentlaw.com](mailto:clare@richardspatentlaw.com)



AO 120 (Rev. 2/99)

<b>TO: Mail Stop 8</b> <b>Director of the U.S. Patent &amp; Trademark Office</b> <b>P.O. Box 1450</b> <b>Alexandria, VA 22313-1450</b>	<b>REPORT ON THE</b> <b>FILING OR DETERMINATION OF AN</b> <b>ACTION REGARDING A PATENT OR</b> <b>TRADEMARK</b>
---	---

In Compliance with 35 § 290 and/or 15 U.S.C. § 1116 you are hereby advised that a court action has been filed in the U.S. District Court Northern District California on the  Patents or  Trademarks:

DOCKET NO. CV 15-05474 JCS	DATE FILED 11/30/15	U.S. DISTRICT COURT 450 Golden Gate Avenue, 16 <sup>th</sup> Floor, San Francisco CA 94102
PLAINTIFF WILLIAM GRECIA		DEFENDANT ADOBE SYSTEMS INCORPORATED
PATENT OR TRADEMARK NO.	DATE OF PATENT OR TRADEMARK	HOLDER OF PATENT OR TRADEMARK
1 8,533,860		***see attach Complaint***
2 8,402,555		
3		
4		
5		

In the above—entitled case, the following patent(s) have been included:

DATE INCLUDED	INCLUDED BY <input type="checkbox"/> Amendment <input type="checkbox"/> Answer <input type="checkbox"/> Cross Bill <input type="checkbox"/> Other Pleading		
PATENT OR TRADEMARK NO.	DATE OF PATENT OR TRADEMARK	HOLDER OF PATENT OR TRADEMARK	
1			
2			
3			
4			
5			

In the above—entitled case, the following decision has been rendered or judgement issued:

DECISION/JUDGEMENT
--------------------

CLERK  SUSAN Y. SOONG	(BY) DEPUTY CLERK  Gina Augustine	DATE  December 2, 2015
-----------------------------	---	------------------------------

Copy 1—Upon initiation of action, mail this copy to Commissioner    Copy 3—Upon termination of action, mail this copy to Commissioner  
 Copy 2—Upon filing document adding patent(s), mail this copy to Commissioner    Copy 4—Case file copy

EWS-003527

AO 120 (Rev. 3/04)

<b>TO: Mail Stop 8 Director of the U.S. Patent and Trademark Office P.O. Box 1450 Alexandria, VA 22313-1450</b>	<b>REPORT ON THE FILING OR DETERMINATION OF AN ACTION REGARDING A PATENT OR TRADEMARK</b>
---	---

In Compliance with 35 U.S.C. § 290 and/or 15 U.S.C. § 1116 you are hereby advised that a court action has been filed in the U.S. District Court Delaware on the following  Patents or Trademarks:

DOCKET NO. 15cv574-RGA	DATE FILED 3/27/2015	U.S. DISTRICT COURT DISTRICT OF DELAWARE
PLAINTIFF William Grecia		DEFENDANT WeideOpenWest Fiance, LLC
PATENT OR TRADEMARK NO.	DATE OF PATENT OR TRADEMARK	HOLDER OF PATENT OR TRADEMARK
1 8,533,860	9/10/2013	William Grecia
2		
3		
4		
5		

In the above—entitled case, the following patent(s)/ trademark(s) have been included:

DATE INCLUDED	INCLUDED BY <input type="checkbox"/> Amendment <input type="checkbox"/> Answer <input type="checkbox"/> Cross Bill <input type="checkbox"/> Other Pleading		
PATENT OR TRADEMARK NO.	DATE OF PATENT OR TRADEMARK	HOLDER OF PATENT OR TRADEMARK	
1			
2			
3			
4			
5			

In the above—entitled case, the following decision has been rendered or judgement issued:

DECISION/JUDGEMENT  See attached Order
--

CLERK JOHN A. CERINO, CLERK OF COURT	(BY) DEPUTY CLERK	DATE 2/5/2016
---	-------------------	------------------

Copy 1—Upon initiation of action, mail this copy to Director    Copy 3—Upon termination of action, mail this copy to Director  
Copy 2—Upon filing document adding patent(s), mail this copy to Director    Copy 4—Case file copy

EWS-003528

AO 120 (Rev. 08/10)

TO: <b>Mail Stop 8</b> <b>Director of the U.S. Patent and Trademark Office</b> <b>P.O. Box 1450</b> <b>Alexandria, VA 22313-1450</b>	<b>REPORT ON THE                  FILING OR DETERMINATION OF AN                  ACTION REGARDING A PATENT OR                  TRADEMARK</b>
---	--

In Compliance with 35 U.S.C. § 290 and/or 15 U.S.C. § 1116 you are hereby advised that a court action has been filed in the U.S. District Court NORTHERN DISTRICT OF ILLINOIS, EASTERN DIVISION on the following

Trademarks or  Patents. (  the patent action involves 35 U.S.C. § 292.):

DOCKET NO. 1:15-cv-02610	DATE FILED 3/27/2015	U.S. DISTRICT COURT NORTHERN DISTRICT OF ILLINOIS, EASTERN DIVISION
PLAINTIFF William Grecia		DEFENDANT AT&T Inc.
PATENT OR TRADEMARK NO.	DATE OF PATENT OR TRADEMARK	HOLDER OF PATENT OR TRADEMARK
1 8,533,860 B1	1/11/2013	William Grecia
2		
3		
4		
5		

In the above—entitled case, the following patent(s)/ trademark(s) have been included:

DATE INCLUDED	INCLUDED BY <input type="checkbox"/> Amendment <input type="checkbox"/> Answer <input type="checkbox"/> Cross Bill <input type="checkbox"/> Other Pleading		
PATENT OR TRADEMARK NO.	DATE OF PATENT OR TRADEMARK	HOLDER OF PATENT OR TRADEMARK	
1			
2			
3			
4			
5			

In the above—entitled case, the following decision has been rendered or judgement issued:

DECISION/JUDGEMENT Stipulation of Dismissal dated 11/12/15 Attached. By Alfred Amistoso, Deputy Clerk  Susan Y. Soong, Clerk
---

CLERK Thomas G. Bruton	(BY) DEPUTY CLERK A.J. Squillante	DATE 3/30/2015
---------------------------	--------------------------------------	-------------------

Copy 1—Upon initiation of action, mail this copy to Director    Copy 3—Upon termination of action, mail this copy to Director  
 Copy 2—Upon filing document adding patent(s), mail this copy to Director    Copy 4—Case file copy

1  
2  
3  
4  
5  
6  
7  
8  
9  
10  
11  
12  
13  
14  
15  
16  
17  
18  
19  
20  
21  
22  
23  
24  
25  
26  
27  
28

[Counsel listed on signature pages]

**UNITED STATES DISTRICT COURT  
NORTHERN DISTRICT OF CALIFORNIA  
SAN FRANCISCO DIVISION**

William Grecia,  
  
Plaintiff,  
  
v.  
  
AT&T Services, Inc.  
  
Defendant.

Case No. 3:15-cv-04360-WHA

**STIPULATION OF DISMISSAL**

---

Judge: Hon. William Alsup

Pursuant to Rule 41(a)(1)(A)(ii) of the Federal Rules of Civil Procedure, Plaintiff William Grecia and Defendant AT&T Services, Inc. ("AT&T") hereby stipulate to the dismissal of this action. All claims for relief asserted against AT&T by Grecia herein are dismissed WITH PREJUDICE; all counterclaims for relief asserted against Grecia by AT&T are dismissed WITHOUT PREJUDICE. Each party to bear its own costs and attorneys' fees.

Date: November 12, 2015

Respectfully Submitted,

/s/ Todd C. Atkins  
Todd C. Atkins  
(CA Bar No. 208879)  
tatkins@siprut.com  
SIPRUT PC  
2261 Rutherford Road  
Carlsbad, CA 92008  
619.665.3476

/s/ Steven D. Moore  
Steven D. Moore  
(CA State Bar No.: 290875)  
smoore@kilpatricktownsend.com  
KILPATRICK TOWNSEND &  
STOCKTON LLP  
Eighth Floor, Two Embarcadero Center  
San Francisco, CA 94111  
Telephone: 415 576 0200  
Facsimile: 415 576 0300

*Counsel for Plaintiff William Grecia*

Attorney for Defendant  
AT&T Services, Inc.

1  
2  
3  
4  
5  
6  
7  
8  
9  
10  
11  
12  
13  
14  
15  
16  
17  
18  
19  
20  
21  
22  
23  
24  
25  
26  
27  
28

**ATTESTATION FOR SIGNATURE**

Pursuant to Civil L.R. 5-1(i)(3) regarding signatures, I attest under penalty of perjury that concurrence in the filing of this document has been obtained from the other signatories.

Date: November 12, 2015

/s/ Todd C. Atkins

4823-6042-5002, v. 1

AO 120 (Rev. 08/10)

<b>TO:</b> <p style="text-align: center;"><b>Mail Stop 8</b>  <b>Director of the U.S. Patent and Trademark Office</b>  <b>P.O. Box 1450</b>  <b>Alexandria, VA 22313-1450</b></p>	<b>REPORT ON THE          FILING OR DETERMINATION OF AN          ACTION REGARDING A PATENT OR          TRADEMARK</b>
--	--

In Compliance with 35 U.S.C. § 290 and/or 15 U.S.C. § 1116 you are hereby advised that a court action has been filed in the U.S. District Court Southern District of Ohio on the following

Trademarks or  Patents. (  the patent action involves 35 U.S.C. § 292.):

DOCKET NO. 3:15-cv-00401	DATE FILED 11/6/2015	U.S. DISTRICT COURT Southern District of Ohio
PLAINTIFF HIGH 5 SPORTSWEAR, INC.		DEFENDANT HIGH 5 GEAR, INC.
PATENT OR TRADEMARK NO.	DATE OF PATENT OR TRADEMARK	HOLDER OF PATENT OR TRADEMARK
1 TM 2,655,715	12/3/2002	HIGH 5 SPORTSWEAR, INC.
2 TM 4,643,221	11/25/2014	HIGH 5 SPORTSWEAR, INC.
3 TM 1,826,408	3/14/1995	HIGH 5 SPORTSWEAR, INC.
4 TM 2,986,882	8/23/2005	HIGH 5 SPORTSWEAR, INC.
5 TM 3,538,295	11/25/2008	HIGH 5 SPORTSWEAR, INC.

In the above—entitled case, the following patent(s)/ trademark(s) have been included:

DATE INCLUDED	INCLUDED BY <input type="checkbox"/> Amendment <input type="checkbox"/> Answer <input type="checkbox"/> Cross Bill <input type="checkbox"/> Other Pleading		
PATENT OR TRADEMARK NO.	DATE OF PATENT OR TRADEMARK	HOLDER OF PATENT OR TRADEMARK	
1 TM 4,068,006	12/6/2011	HIGH 5 SPORTSWEAR, INC.	
2			
3			
4			
5			

In the above—entitled case, the following decision has been rendered or judgement issued:

DECISION/JUDGEMENT
--------------------

CLERK	(BY) DEPUTY CLERK	DATE
-------	-------------------	------

Copy 1—Upon initiation of action, mail this copy to Director    Copy 3—Upon termination of action, mail this copy to Director  
 Copy 2—Upon filing document adding patent(s), mail this copy to Director    Copy 4—Case file copy

EWS-003532

AO 120 (Rev. 08/10)

TO: <b>Mail Stop 8</b> <b>Director of the U.S. Patent and Trademark Office</b> P.O. Box 1450 Alexandria, VA 22313-1450	<b>REPORT ON THE                  FILING OR DETERMINATION OF AN                  ACTION REGARDING A PATENT OR                  TRADEMARK</b>
---	--

In Compliance with 35 U.S.C. § 290 and/or 15 U.S.C. § 1116 you are hereby advised that a court action has been filed in the U.S. District Court the Northern District of Illinois on the following  
 Trademarks or  Patents. (  the patent action involves 35 U.S.C. § 292.):

DOCKET NO. 15CV2620	DATE FILED 3/27/2015	U.S. DISTRICT COURT the Northern District of Illinois
PLAINTIFF William Grecia		DEFENDANT DISH Network L.L.C
PATENT OR TRADEMARK NO.	DATE OF PATENT OR TRADEMARK	HOLDER OF PATENT OR TRADEMARK
1 8,533,860	9/10/2013	William Grecia
2		
3		
4		
5		

In the above—entitled case, the following patent(s)/ trademark(s) have been included:

DATE INCLUDED	INCLUDED BY <input type="checkbox"/> Amendment <input type="checkbox"/> Answer <input type="checkbox"/> Cross Bill <input type="checkbox"/> Other Pleading	
PATENT OR TRADEMARK NO.	DATE OF PATENT OR TRADEMARK	HOLDER OF PATENT OR TRADEMARK
1		
2		
3		
4		
5		

In the above—entitled case, the following decision has been rendered or judgement issued:

DECISION/JUDGEMENT
--------------------

CLERK	(BY) DEPUTY CLERK Julie S. Leopold	DATE 3/30/2015
-------	---------------------------------------	-------------------

Copy 1—Upon initiation of action, mail this copy to Director    Copy 3—Upon termination of action, mail this copy to Director  
 Copy 2—Upon filing document adding patent(s), mail this copy to Director    Copy 4—Case file copy

<b>TO:</b> <b>Mail Stop 8</b> <b>Director of the U.S. Patent and Trademark Office</b> <b>P.O. Box 1450</b> <b>Alexandria, VA 22313-1450</b>	<b>REPORT ON THE</b> <b>FILING OR DETERMINATION OF AN</b> <b>ACTION REGARDING A PATENT OR</b> <b>TRADEMARK</b>
---	---

In Compliance with 35 U.S.C. § 290 and/or 15 U.S.C. § 1116 you are hereby advised that a court action has been filed in the U.S. District Court Eastern District of Wisconsin on the following

Trademarks or  Patents. (  the patent action involves 35 U.S.C. § 292.);

DOCKET NO. 15-cv-569	DATE FILED 5/12/2015	U.S. DISTRICT COURT Eastern District of Wisconsin
PLAINTIFF William Grecia		DEFENDANT Charter Communications Inc
PATENT OR TRADEMARK NO.	DATE OF PATENT OR TRADEMARK	HOLDER OF PATENT OR TRADEMARK
1 8,533,860	9/10/2013	William Grecia
2		
3		
4		
5		

In the above—entitled case, the following patent(s)/ trademark(s) have been included:

DATE INCLUDED	INCLUDED BY	
	<input type="checkbox"/> Amendment <input type="checkbox"/> Answer <input type="checkbox"/> Cross Bill <input type="checkbox"/> Other Pleading	
PATENT OR TRADEMARK NO.	DATE OF PATENT OR TRADEMARK	HOLDER OF PATENT OR TRADEMARK
1		
2		
3		
4		
5		

In the above—entitled case, the following decision has been rendered or judgement issued:

DECISION/JUDGEMENT
--------------------

CLERK Jon W. Sanfilippo	(BY) DEPUTY CLERK s/Becky Ray	DATE 5/12/2015
----------------------------	----------------------------------	-------------------

Copy 1—Upon initiation of action, mail this copy to Director    Copy 3—Upon termination of action, mail this copy to Director  
 Copy 2—Upon filing document adding patent(s), mail this copy to Director    Copy 4—Case file copy



<b>TO:</b> <b>Mail Stop 8</b> <b>Director of the U.S. Patent and Trademark Office</b> <b>P.O. Box 1450</b> <b>Alexandria, VA 22313-1450</b>	<b>REPORT ON THE</b> <b>FILING OR DETERMINATION OF AN</b> <b>ACTION REGARDING A PATENT OR</b> <b>TRADEMARK</b>
---	---

In Compliance with 35 U.S.C. § 290 and/or 15 U.S.C. § 1116 you are hereby advised that a court action has been filed in the U.S. District Court Eastern District of Wisconsin on the following

Trademarks or  Patents. (  the patent action involves 35 U.S.C. § 292.);

DOCKET NO. 15-cv-570	DATE FILED 5/12/2015	U.S. DISTRICT COURT Eastern District of Wisconsin
PLAINTIFF William Grecia		DEFENDANT Time Warner Cable Inc
PATENT OR TRADEMARK NO.	DATE OF PATENT OR TRADEMARK	HOLDER OF PATENT OR TRADEMARK
1 8,533,860	9/10/2013	William Grecia
2		
3		
4		
5		

In the above—entitled case, the following patent(s)/ trademark(s) have been included:

DATE INCLUDED	INCLUDED BY	
	<input type="checkbox"/> Amendment <input type="checkbox"/> Answer <input type="checkbox"/> Cross Bill <input type="checkbox"/> Other Pleading	
PATENT OR TRADEMARK NO.	DATE OF PATENT OR TRADEMARK	HOLDER OF PATENT OR TRADEMARK
1		
2		
3		
4		
5		

In the above—entitled case, the following decision has been rendered or judgement issued:

DECISION/JUDGEMENT
--------------------

CLERK Jon W. Sanfilippo	(BY) DEPUTY CLERK s/Mary Murawski	DATE 5/12/2015
----------------------------	--------------------------------------	-------------------

Copy 1—Upon initiation of action, mail this copy to Director    Copy 3—Upon termination of action, mail this copy to Director  
Copy 2—Upon filing document adding patent(s), mail this copy to Director    Copy 4—Case file copy

AO 120 (Rev. 08/10)

TO: <b>Mail Stop 8</b> <b>Director of the U.S. Patent and Trademark Office</b> <b>P.O. Box 1450</b> <b>Alexandria, VA 22313-1450</b>	<b>REPORT ON THE</b> <b>FILING OR DETERMINATION OF AN</b> <b>ACTION REGARDING A PATENT OR</b> <b>TRADEMARK</b>
---	---

In Compliance with 35 U.S.C. § 290 and/or 15 U.S.C. § 1116 you are hereby advised that a court action has been filed in the U.S. District Court Northern District of Illinois on the following

Trademarks or  Patents. (  the patent action involves 35 U.S.C. § 292.):

DOCKET NO. 15CV2625	DATE FILED 3/31/2015	U.S. DISTRICT COURT Northern District of Illinois
PLAINTIFF William Grecia		DEFENDANT WideOpenWest Finance, LLC
PATENT OR TRADEMARK NO.	DATE OF PATENT OR TRADEMARK	HOLDER OF PATENT OR TRADEMARK
1 8,533,860	9/10/2013	William Grecia
2		
3		
4		
5		

In the above—entitled case, the following patent(s)/ trademark(s) have been included:

DATE INCLUDED	INCLUDED BY <input type="checkbox"/> Amendment <input type="checkbox"/> Answer <input type="checkbox"/> Cross Bill <input type="checkbox"/> Other Pleading		
PATENT OR TRADEMARK NO.	DATE OF PATENT OR TRADEMARK	HOLDER OF PATENT OR TRADEMARK	
1			
2			
3			
4			
5			

In the above—entitled case, the following decision has been rendered or judgement issued:

DECISION/JUDGEMENT
--------------------

CLERK	(BY) DEPUTY CLERK Julie S. Leopold	DATE 3/31/2015
-------	---------------------------------------	-------------------

Copy 1—Upon initiation of action, mail this copy to Director    Copy 3—Upon termination of action, mail this copy to Director  
 Copy 2—Upon filing document adding patent(s), mail this copy to Director    Copy 4—Case file copy



US008533860B1

(12) **United States Patent**  
**Grecia**

(10) **Patent No.:** **US 8,533,860 B1**  
(45) **Date of Patent:** **\*Sep. 10, 2013**

(54) **PERSONALIZED DIGITAL MEDIA ACCESS SYSTEM—PDMAS PART II**

(71) Applicant: **William Grecia**, Brooklyn, NY (US)

(72) Inventor: **William Grecia**, Brooklyn, NY (US)

(\* ) Notice: Subject to any disclaimer, the term of this patent is extended or adjusted under 35 U.S.C. 154(b) by 0 days.  
  
This patent is subject to a terminal disclaimer.

(21) Appl. No.: **13/740,086**

(22) Filed: **Jan. 11, 2013**

(51) **Int. Cl.**  
**H04L 29/06** (2006.01)

(52) **U.S. Cl.**  
USPC ..... **726/29; 725/28; 713/185; 705/51**

(58) **Field of Classification Search**  
None  
See application file for complete search history.

2012/0041829	A1	2/2012	Rothschild
2012/0079095	A1	3/2012	Evans
2012/0079126	A1	3/2012	Evans
2012/0079276	A1	3/2012	Evans
2012/0079606	A1	3/2012	Evans
2012/0095871	A1	4/2012	Dorsey
2012/0095906	A1	4/2012	Dorsey
2012/0095916	A1	4/2012	Dorsey
2012/0130903	A1	5/2012	Dorsey
2012/0150727	A1	6/2012	Nuzzi
2012/0166333	A1	6/2012	Von Behren
2012/0173333	A1	7/2012	Berger
2012/0173431	A1	7/2012	Ritchie
2012/0173625	A1	7/2012	Berger
2012/0191553	A1	7/2012	Sathe
2012/0254340	A1	10/2012	Velummylum
2012/0255033	A1	10/2012	Dwivedi
2012/0290376	A1	11/2012	Dryer
2012/0296741	A1	11/2012	Dykes
2012/0310828	A1	12/2012	Hu
2013/0007892	A1	1/2013	Inooka

**OTHER PUBLICATIONS**

Co-pending U.S. Appl. No. 13/397,517 document reference: Jan. 7, 2013 Examiner initiated interview summary (PTOL-413B).  
Co-pending U.S. Appl. No. 13/397,517 document reference: Dec. 26, 2012 Advisory Action (PTOL-303).  
Co-pending U.S. Appl. 13/397,517 document reference: Nov. 26, 2012 Final Rejection.

(56) **References Cited**

(Continued)

**U.S. PATENT DOCUMENTS**

7,254,235	B2	8/2007	Boudreault et al.	
7,343,014	B2	3/2008	Sovio et al.	
7,526,650	B1*	4/2009	Wimmer	713/176
8,250,145	B2	8/2012	Zuckerberg	
8,280,959	B1	10/2012	Zuckerberg	
2005/0065891	A1	3/2005	Lee et al.	
2008/0010685	A1	1/2008	Holtzman et al.	
2009/0083541	A1	3/2009	Levine	
2010/0100899	A1	4/2010	Bradbury et al.	
2011/0208695	A1	8/2011	Anand	
2011/0265157	A1	10/2011	Ryder	
2011/0288946	A1*	11/2011	Baiya et al.	705/26.1
2011/0313898	A1	12/2011	Singhal	
2011/0320345	A1	12/2011	Taveau	

*Primary Examiner* — Jung Kim  
*Assistant Examiner* — Tri Tran

(57) **ABSTRACT**

The invention is an apparatus that facilitates access to a data source to accept verification and authentication from an enabler using at least one token and at least one reference. The at least one reference could be a device serial number, a networking MAC address, or a membership ID reference from a web service. Access to the data source is also managed with a plurality of secondary enablers.

**30 Claims, 7 Drawing Sheets**

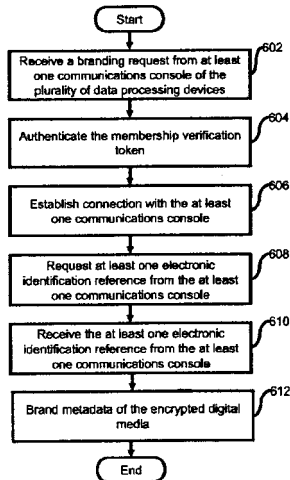

UNITED STATES PATENT AND TRADEMARK OFFICE

---

BEFORE THE PATENT TRIAL AND APPEAL BOARD

---

SONY NETWORK ENTERTAINMENT INTERNATIONAL LLC,  
Petitioner,

v.

WILLIAM GRECIA,  
Patent Owner.

---

Case IPR2015-00422  
Patent 8,533,860 B1

---

Before GLENN J. PERRY, RAMA G. ELLURU, and JASON J. CHUNG,  
*Administrative Patent Judges.*

CHUNG, *Administrative Patent Judge.*

JUDGMENT  
Dismissing the Petition  
*37 C.F.R. §§ 42.5(a), 42.71(a)*

On May 13, 2015, Patent Owner William Grecia (“Grecia”) and Petitioner Sony Network Entertainment International LLC (“Sony”) filed a Joint Motion to Terminate Proceeding under 35 U.S.C. § 317(a) (Paper 11), a true copy of the written settlement agreement (Ex. 1011), and a Joint Request to File Settlement Agreement as Business Confidential Information and to keep separate the agreement pursuant to 35 U.S.C. § 317(b) and 37 C.F.R. § 42.74 (Paper 12). Sony filed a Petition for an *inter partes* review of U.S. Patent No. 8,533,860 on December 11, 2014, and Grecia filed a Preliminary Response on March 11, 2015. The Board has not yet determined, under 35 U.S.C. § 314, whether or not to institute a review in the instant case. As no trial has been instituted based on Sony’s Petition, this matter is in the preliminary proceeding<sup>1</sup> stage.

Under 35 U.S.C. § 317(a), “[a]n *inter partes* review instituted under this chapter shall be terminated with respect to any petitioner upon the joint request of the petitioner and the patent owner, unless the Office has decided the merits of the proceeding before the request for termination is filed.”

Generally, the Board expects that a proceeding will terminate as to settling parties after the filing of a settlement agreement. *See, e.g.*, Office Patent Trial Practice Guide, 77 Fed. Reg. 48,756, 48,768 (Aug. 14, 2012).

The Board is persuaded that, under these circumstances, it is appropriate to terminate this case. *See* 37 C.F.R. §§ 42.5(a), 42.71(a).

Accordingly, it is:

ORDERED that the joint motion to terminate with respect to both parties is GRANTED, and the Petition is hereby dismissed; and

---

<sup>1</sup> A preliminary proceeding begins with the filing of a petition for instituting a trial and ends with a written decision as to whether trial will be instituted. 37 C.F.R. § 42.2.

IPR2015-00422  
Patent 8,533,860 B1

FURTHER ORDERED that the parties' joint request that the written settlement agreement (Ex. 1011) be: (i) treated as business confidential information; (ii) kept separate from the file of the '860 patent; (iii) kept confidential from any third party; and (iv) made available only to Federal Government agencies on written request, or to any person on a showing of good cause, under the provisions of 35 U.S.C. § 317(b) and 37 C.F.R. § 42.74(c), is GRANTED.

For Petitioner:

Paul C. Haughey  
Scott Kolassa  
KILPATRICK TOWNSEND & STOCKTON LLP  
[phaughey@kilpatricktownsend.com](mailto:phaughey@kilpatricktownsend.com)  
[skolassa@kilpatricktownsend.com](mailto:skolassa@kilpatricktownsend.com)

For Patent Owner:

Patrick Richards  
Alisha Taylor  
RICHARDS PATENT LAW P.C.  
[Patrick@richardspatentlaw.com](mailto:Patrick@richardspatentlaw.com)  
[alisha@richardspatentlaw.com](mailto:alisha@richardspatentlaw.com)

AO 120 (Rev. 08/10)

TO: <b>Mail Stop 8</b> <b>Director of the U.S. Patent and Trademark Office</b> <b>P.O. Box 1450</b> <b>Alexandria, VA 22313-1450</b>	<b>REPORT ON THE</b> <b>FILING OR DETERMINATION OF AN</b> <b>ACTION REGARDING A PATENT OR</b> <b>TRADEMARK</b>
---	---

In Compliance with 35 U.S.C. § 290 and/or 15 U.S.C. § 1116 you are hereby advised that a court action has been filed in the U.S. District Court the Northern District of Illinois on the following

Trademarks or  Patents. (  the patent action involves 35 U.S.C. § 292.);

DOCKET NO. 15CV2620	DATE FILED 3/27/2015	U.S. DISTRICT COURT the Northern District of Illinois
PLAINTIFF William Grecia		DEFENDANT DISH Network L.L.C
PATENT OR TRADEMARK NO.	DATE OF PATENT OR TRADEMARK	HOLDER OF PATENT OR TRADEMARK
1 8,533,860	9/10/2013	William Grecia
2		
3		
4		
5		

In the above—entitled case, the following patent(s)/ trademark(s) have been included:

DATE INCLUDED	INCLUDED BY <input type="checkbox"/> Amendment <input type="checkbox"/> Answer <input type="checkbox"/> Cross Bill <input type="checkbox"/> Other Pleading		
PATENT OR TRADEMARK NO.	DATE OF PATENT OR TRADEMARK	HOLDER OF PATENT OR TRADEMARK	
1			
2			
3			
4			
5			

In the above—entitled case, the following decision has been rendered or judgement issued:

DECISION/JUDGEMENT
--------------------

CLERK	(BY) DEPUTY CLERK Julie S. Leopold	DATE 3/30/2015
-------	---------------------------------------	-------------------

Copy 1—Upon initiation of action, mail this copy to Director Copy 3—Upon termination of action, mail this copy to Director  
 Copy 2—Upon filing document adding patent(s), mail this copy to Director Copy 4—Case file copy

EWS-003541

AO 120 (Rev. 2/99)

<b>TO: Mail Stop 8</b> <b>Director of the U.S. Patent &amp; Trademark Office</b> P.O. Box 1450 Alexandria, VA 22313-1450	<b>REPORT ON THE</b> <b>FILING OR DETERMINATION OF AN</b> <b>ACTION REGARDING A PATENT OR</b> <b>TRADEMARK</b>
---	---

In Compliance with 35 § 290 and/or 15 U.S.C. § 1116 you are hereby advised that a court action has been filed in the U.S. District Court Northern District California on the  Patents or  Trademarks:

DOCKET NO. CV 15-01103 JCS	DATE FILED 3/9/15	U.S. DISTRICT COURT 450 Golden Gate Avenue, 16 <sup>th</sup> Floor, San Francisco CA 94102
PLAINTIFF WILLIAM GRECIA		DEFENDANT AMAZON.COM, INC
PATENT OR TRADEMARK NO.	DATE OF PATENT OR TRADEMARK	HOLDER OF PATENT OR TRADEMARK
1 8,533,860		***see attach Complaint***
2		
3		
4		
5		

In the above—entitled case, the following patent(s) have been included:

DATE INCLUDED	INCLUDED BY <input type="checkbox"/> Amendment <input type="checkbox"/> Answer <input type="checkbox"/> Cross Bill <input type="checkbox"/> Other Pleading		
PATENT OR TRADEMARK NO.	DATE OF PATENT OR TRADEMARK	HOLDER OF PATENT OR TRADEMARK	
1			
2			
3			
4			
5			

In the above—entitled case, the following decision has been rendered or judgement issued:

DECISION/JUDGEMENT
--------------------

CLERK Richard W. Wiekling	(BY) DEPUTY CLERK Gina Augustine	DATE March 11, 2015
------------------------------	-------------------------------------	------------------------

Copy 1—Upon initiation of action, mail this copy to Commissioner    Copy 3—Upon termination of action, mail this copy to Commissioner  
 Copy 2—Upon filing document adding patent(s), mail this copy to Commissioner    Copy 4—Case file copy

EWS-003542





UNITED STATES PATENT AND TRADEMARK OFFICE

UNITED STATES DEPARTMENT OF COMMERCE
United States Patent and Trademark Office
Address: COMMISSIONER FOR PATENTS
P.O. Box 1450
Alexandria, Virginia 22313-1450
www.uspto.gov

Table with 5 columns: APPLICATION NO., FILING DATE, FIRST NAMED INVENTOR, ATTORNEY DOCKET NO., CONFIRMATION NO.
12/766,337 04/23/2010 Scott Ryder P8690US1/14280US.1 1214

47743 7590 12/29/2014
WOMBLE CARLYLE SANDRIDGE & RICE LLP
Attn: IP Docketing
P. O. BOX 7037
ATLANTA, GA 30357-0037

EXAMINER

REVAK, CHRISTOPHER A

ART UNIT PAPER NUMBER

2431

NOTIFICATION DATE DELIVERY MODE

12/29/2014

ELECTRONIC

Please find below and/or attached an Office communication concerning this application or proceeding.

The time period for reply, if any, is set in the attached communication.

Notice of the Office communication was sent electronically on above-indicated "Notification Date" to the following e-mail address(es):

IPDocketing@WCSR.com

**Office Action Summary****Application No.**  
12/766,337**Applicant(s)**  
RYDER, SCOTT**Examiner**  
CHRISTOPHER REVAK**Art Unit**  
2431**AIA (First Inventor to File) Status**  
No**-- The MAILING DATE of this communication appears on the cover sheet with the correspondence address --****Period for Reply**A SHORTENED STATUTORY PERIOD FOR REPLY IS SET TO EXPIRE 3 MONTHS FROM THE MAILING DATE OF THIS COMMUNICATION.

- Extensions of time may be available under the provisions of 37 CFR 1.136(a). In no event, however, may a reply be timely filed after SIX (6) MONTHS from the mailing date of this communication.
- If NO period for reply is specified above, the maximum statutory period will apply and will expire SIX (6) MONTHS from the mailing date of this communication.
- Failure to reply within the set or extended period for reply will, by statute, cause the application to become ABANDONED (35 U.S.C. § 133). Any reply received by the Office later than three months after the mailing date of this communication, even if timely filed, may reduce any earned patent term adjustment. See 37 CFR 1.704(b).

**Status**

- 1)  Responsive to communication(s) filed on 6/20/14.  
 A declaration(s)/affidavit(s) under **37 CFR 1.130(b)** was/were filed on \_\_\_\_\_.
- 2a)  This action is **FINAL**.
- 2b)  This action is non-final.
- 3)  An election was made by the applicant in response to a restriction requirement set forth during the interview on \_\_\_\_\_; the restriction requirement and election have been incorporated into this action.
- 4)  Since this application is in condition for allowance except for formal matters, prosecution as to the merits is closed in accordance with the practice under *Ex parte Quayle*, 1935 C.D. 11, 453 O.G. 213.

**Disposition of Claims\***

- 5)  Claim(s) 1-15 and 19-22 is/are pending in the application.  
5a) Of the above claim(s) \_\_\_\_\_ is/are withdrawn from consideration.
- 6)  Claim(s) \_\_\_\_\_ is/are allowed.
- 7)  Claim(s) 1-15 and 19-22 is/are rejected.
- 8)  Claim(s) \_\_\_\_\_ is/are objected to.
- 9)  Claim(s) \_\_\_\_\_ are subject to restriction and/or election requirement.

\* If any claims have been determined allowable, you may be eligible to benefit from the **Patent Prosecution Highway** program at a participating intellectual property office for the corresponding application. For more information, please see [http://www.uspto.gov/patents/init\\_events/pph/index.jsp](http://www.uspto.gov/patents/init_events/pph/index.jsp) or send an inquiry to [PPHfeedback@uspto.gov](mailto:PPHfeedback@uspto.gov).

**Application Papers**

- 10)  The specification is objected to by the Examiner.
- 11)  The drawing(s) filed on 4/23/10 is/are: a)  accepted or b)  objected to by the Examiner.  
Applicant may not request that any objection to the drawing(s) be held in abeyance. See 37 CFR 1.85(a).  
Replacement drawing sheet(s) including the correction is required if the drawing(s) is objected to. See 37 CFR 1.121(d).

**Priority under 35 U.S.C. § 119**

- 12)  Acknowledgment is made of a claim for foreign priority under 35 U.S.C. § 119(a)-(d) or (f).

**Certified copies:**

- a)  All b)  Some\*\* c)  None of the:
  - 1.  Certified copies of the priority documents have been received.
  - 2.  Certified copies of the priority documents have been received in Application No. \_\_\_\_\_.
  - 3.  Copies of the certified copies of the priority documents have been received in this National Stage application from the International Bureau (PCT Rule 17.2(a)).

\*\* See the attached detailed Office action for a list of the certified copies not received.

**Attachment(s)**

- 1)  Notice of References Cited (PTO-892)
- 2)  Information Disclosure Statement(s) (PTO/SB/08a and/or PTO/SB/08b)  
Paper No(s)/Mail Date \_\_\_\_\_
- 3)  Interview Summary (PTO-413)  
Paper No(s)/Mail Date \_\_\_\_\_
- 4)  Other: \_\_\_\_\_

Art Unit: 2431

1. The present application is being examined under the pre-AIA first to invent provisions.

## **DETAILED ACTION**

### ***Response to Arguments***

2. It is noted that the Applicant's statement in regards to the Interview Summary dated June 18, 2014 is inaccurate that the amended claim were deemed to be allowable over the cited prior art. Upon review of the previous Examiner's notes, it was agreed upon that the previously cited portions addressed by the Examiner in the previous office action dated March 20, 2014 did not teach the amended language in during that interview. Upon further consideration of the teachings of Grecia, the teachings were found to meet the Applicant's amended claim limitations, please refer below to the amended rejection of the claims.

### ***Claim Rejections - 35 USC § 103***

3. The following is a quotation of pre-AIA 35 U.S.C. 103(a) which forms the basis for all obviousness rejections set forth in this Office action:

(a) A patent may not be obtained though the invention is not identically disclosed or described as set forth in section 102 of this title, if the differences between the subject matter sought to be patented and the prior art are such that the subject matter as a whole would have been obvious at the time the invention was made to a person having ordinary skill in the art to which said subject matter pertains. Patentability shall not be negated by the manner in which the invention was made.

Art Unit: 2431

4. Claims 1-15 and 19-22 are rejected under pre-AIA 35 U.S.C. 103(a) as being unpatentable over Grecia, U.S. Patent 8,402,555.

(A) As per claim 1, Grecia discloses a method for authorizing a second user to access content stored on a local cloud (A method of providing unlimited interoperability of digital media between unlimited machines with management of end-user access to the digital media; a method for monitoring access to an encrypted digital media, the method facilitating interoperability between a plurality of data processing devices) (col. 3 lines 10-13; col. 14 lines 36-38), comprising:

receiving, at a librarian service operating on a master device (system/ apparatus shown in FIGS. 1-2; cloud system; cloud storage systems such as Amazon's Web Services Simple Storage Solution or also known as S3) (FIGS. 1-2; col. 5 lines 40-45; col. 6 lines 12-17; col. 9 lines 8-15; col. 15 line 49), a request from a first device owned by a first user to provide a second user with access to content stored on a second device owned the first user (receiving an encrypted digital media access branding request from a communications console of the plurality of data processing devices, wherein the branding request being a request from one or more secondary users connected to the first user, the one or more secondary users comprising one or more of human beings or programmed computerized mechanisms in network of the first user, wherein the one or more secondary users are validated by a membership web service) (FIG. 6: 602; col. 9 lines 20-23; col. 13 line 65 to col. 14 line 22; col. 14 lines 39-45; col. 15 lines 8-15), the local cloud comprising the first and second devices are selected by

Art Unit: 2431

the first user for inclusion in the local cloud (managing access rights across a plurality of devices; providing unlimited interoperability of digital media between unlimited machines with management of end-user access to the digital media; give users freedom to use products outside of the device in which the product was acquired and extend unlimited interoperability with other compatible devices; Another example is a content provider can allow shared access to friends of the excelsior enabler after a time period, like for example, 90 days. After the 90 day period, when media access is requested using the authentication element by a plurality of secondary enablers, which are usually friends and family of the excelsior enabler, the FBID of the excelsior enabler is cross-referenced with the FBID of the requesting secondary enabler by way of the apparatus ability to execute the Facebook "Friends.areFriends" API command.; receiving an encrypted digital media access branding request from a communications console of the plurality of data processing devices, wherein the branding request being a request from one or more secondary users connected to the first user, the one or more secondary users comprising one or more of human beings or programmed computerized mechanisms in network of the first user, wherein the one or more secondary users are validated by a membership web service) (col. 1 lines 24-26; col. 3 lines 10-13; col. 4 lines 6-10; col. 12 lines 10-18; col. 15 lines 8-15);

receiving, at the librarian service from the second device, an indication that the second user is authorized to access the content stored on the second device (The apparatus can ask the potential secondary enabler to participate in communication with the authentication element. The apparatus requires the potential secondary enabler to

Art Unit: 2431

participate in communication with the authentication element to provide credentials to establish a cross-reference comparison with the FBID retrieved from the metadata and the FBID retrieved from the Facebook "Friends.areFriends" API command to determine if the potential secondary enabler identity is true or false;) (col. 13 line 66 to col. 14 line 10; col. 15 lines 3-18);

determining, at the librarian service, whether the second user is known to the librarian service (determining if the potential secondary enabler identity is true or false, wherein the one or more secondary users are validated by a membership web service, wherein a membership verification token represents verification from content provider to grant access rights to the first user and the one or more secondary users) (col. 14 lines 9-10; col. 15 lines 8-18);

in response to determining that the second user is known, identifying credentials associated with the second user (e.g., MAC address and FBID) (If the comparison action proves to be true, then access rights is granted to the secondary enabler. The current MAC address of the networking card as part of The App and the FBID retrieved are appended to the established metadata information the encrypted digital media asset and access rights can be granted to a plurality of secondary enablers.) (col. 14 lines 12-18);

associating the credentials of the second user with the content (If the comparison action proves to be true, then access rights is granted to the secondary enabler. The current MAC address of the networking card as part of The App and the FBID retrieved are appended to the established metadata information the encrypted digital media asset

Art Unit: 2431

and access rights can be granted to a plurality of secondary enablers.) (col. 14 lines 12-18); and

sending, from the librarian service, an indication to the second user to connect to the local cloud to view the content (FIG. 7 shows a flowchart showing authoring an encrypted digital media. The one or more media items are encrypted to create the encrypted digital media at the step 710.; accessing the digital media as shown in FIG. 5; access rights are granted to a plurality of secondary enablers by the system; unlimited interoperability between devices and “fair use” sharing partners for an infinite time frame; wherein the encrypted digital media is shared with one or more users according to a membership) (col. 8 lines 5-6, lines 31-33, lines 41-42; col. 14 lines 12-22; col. 15 lines 19-21).

The teachings of Grecia mention that access by the device is enabled by physical authentication of the enabler who enters their credentials at the device, see col. 11, lines 11-16 and col. 13, lines 3-5 & 45-53. The teachings also disclose of granting permission to a plurality of secondary enablers, see col. 9, lines 21-23. Although the teachings fail to explicitly recite that the secondary enablers (second user) connects to the local cloud via a third device associated with the second user, it is obvious to one of ordinary skill in the art that the teachings of Grecia can be interpreted in this manner. Grecia discloses that access rights are managed across a plurality of devices (col. 13, lines 22-24) and that any compatible device associated with the secondary enabler (second user) can be authenticated as indicated by the excelsior enabler (first user), see the abstract and col. 11, lines 11-16. According to

Art Unit: 2431

the Supreme Court, the teaching, suggestion, or motivation test (TSM test) is one of a number of valid rationales that could be used to determine obviousness. It is not the only rationale that may be relied upon to support a conclusion of obviousness. (*KSR International Co. v. Teleflex Inc.*, 82 USPQ2d 1385 (2007)). The claim would have been obvious because the substitution of one known element for another would have yielded predictable results to one of ordinary skill in the art at the time of the invention.

(B) As per claim 2, Grecia discloses further comprising:

identifying the first user providing the request (Once an enabler executes an action for access request, the apparatus will obtain the decryption key to first seek the MAC address record. If the MAC address is found, then a cross-reference process is executed by comparing the MAC address retrieved from the metadata of the digital media file with the MAC address retrieved from the networking card connected to the apparatus or the App. If the comparison action proves to be true, then access right are granted to the enabler.) (col. 13 lines 45-53); and

determining whether the first user is authorized to grant access to the content (Cross-referencing is used to verify access rights of an enabler or secondary enabler. If the MAC address is found, then a cross-reference process is executed by comparing the MAC address retrieved from the metadata of the digital media file with the MAC address retrieved from the networking card connected to the apparatus or the App. If



Art Unit: 2431

the comparison action proves to be true, then access rights are granted to the enabler.)  
(col. 13 lines 45-53; col. 13 line 65 to col. 14 line 18).

(C) As per claim 3, Grecia discloses wherein:

the request comprises identifying information for the second user (secondary enabler provides credentials to establish a cross-reference comparison with the FBID retrieved from the metadata and the FBID retrieved from the Facebook “Friends.areFriends” API command) (col. 14 lines 3-10).

(D) As per claim 4, Grecia discloses wherein the identifying information comprises at least one of:

an email address (see the login ID in FIG. 3: 307, FIG. 4: 407, and FIG. 5: 509); ;  
and a telephone number.

(E) As per claim 5, Grecia discloses further comprising:

determining that the second user is a new user; and generating new credentials for the second user (The token represents permission from the content provider to grant access rights to the excelsior enabler and thereafter the plurality of secondary enablers. To set up the verification the content provider can manually or automatically generate a single or a plurality of structured or random password in which will represent the token.)  
(col. 9 lines 20-25).

Art Unit: 2431

(F) As per claim 6, Grecia discloses wherein said identifying credentials associated with the second user further comprises:

retrieving previously generated credentials associated with the second user (If the FBID cross-reference fails, then the apparatus can either ask the potential secondary enabler to participate in communication with the authentication element of the invention, or could deny further interactivity with the potential secondary enabler. In this discussion, the apparatus requires the potential secondary enabler to participate in communication with the authentication element to provide credentials to establish a cross-reference comparison with the FBID retrieved from the metadata and the FBID retrieved from the Facebook "Friends.areFriends" API command to determine if the potential secondary enabler identity is true or false. The determination is in accordance to any possible access grace periods set by the content provider of the encrypted digital media asset. If the comparison action proves to be true, then access rights is granted to the secondary enabler and the current MAC address of the networking card as part of The App and the FBID retrieved are appended to the established metadata information of the encrypted digital media asset and access rights can be granted to a plurality of secondary enablers) (col. 13 line 66 to col. 14 line 18).

(G) As per claim 7, Grecia discloses wherein authorizing further comprises:

adding the credentials to an access control list associated with the content (storing a complete list of a plurality of FBIDs to the key file or the metadata thereof;

Art Unit: 2431

writing information to the digital media metadata, the information including the MAC address, CRC checksum, etc.) (col. 11 line 60 to col. 12 line 9; col. 12 lines 44-55).

(H) As per claim 8, Grecia discloses further comprising providing addressing information for the local cloud to the second user, wherein said providing further comprises:

providing a network address for at least one node of the local cloud (MAC address from a networking card; retrieving the MAC address) (col. 12 lines 44-58; col. 13 line 43 to col. 14 line 22 discusses the process of using MAC addresses).

(I) As per claim 9, Grecia discloses wherein:

the at least one node operates a service indicating how to access the content (membership service validates secondary users using a membership verification token representing verification from content provider to grant access rights to the first user and one or more secondary users) (col. 15 lines 8-18).

(J) Claims 10-15 and 19-20 repeat the limitations of claims 1-9, and are therefore rejected for the same reasons as those claims, and incorporated herein.

Art Unit: 2431

(K) As per claims 21, Grecia teaches wherein:

Sending an indication to the second user comprising providing, to the second user, a link to the content (col. 6, lines 21-23 and col. 9, lines 21-23).

(L) As per claim 22, Grecia discloses wherein:

Sending an indication to the second user comprises providing, to the second user, an instruction to operate a particular application used to access the content (col. 6, lines 21-23 and col. 9, lines 21-23).

### ***Conclusion***

5. Applicant's amendment necessitated the new ground(s) of rejection presented in this Office action. Accordingly, **THIS ACTION IS MADE FINAL**. See MPEP § 706.07(a). Applicant is reminded of the extension of time policy as set forth in 37 CFR 1.136(a).

A shortened statutory period for reply to this final action is set to expire THREE MONTHS from the mailing date of this action. In the event a first reply is filed within TWO MONTHS of the mailing date of this final action and the advisory action is not mailed until after the end of the THREE-MONTH shortened statutory period, then the shortened statutory period will expire on the date the advisory action is mailed, and any extension fee pursuant to 37 CFR 1.136(a) will be calculated from the mailing date of

Art Unit: 2431

the advisory action. In no event, however, will the statutory period for reply expire later than SIX MONTHS from the date of this final action.

Any inquiry concerning this communication or earlier communications from the examiner should be directed to CHRISTOPHER REVAK whose telephone number is (571)272-3794. The examiner can normally be reached on Monday-Thursday, 8:00am-4:00pm.

If attempts to reach the examiner by telephone are unsuccessful, the examiner's supervisor, Cordelia Zecher can be reached on 571-272-7771. The fax phone number for the organization where this application or proceeding is assigned is 571-273-8300.

Information regarding the status of an application may be obtained from the Patent Application Information Retrieval (PAIR) system. Status information for published applications may be obtained from either Private PAIR or Public PAIR. Status information for unpublished applications is available through Private PAIR only. For more information about the PAIR system, see <http://pair-direct.uspto.gov>. Should you have questions on access to the Private PAIR system, contact the Electronic Business Center (EBC) at 866-217-9197 (toll-free). If you would like assistance from a USPTO Customer Service Representative or access to the automated information system, call 800-786-9199 (IN USA OR CANADA) or 571-272-1000.

/CHRISTOPHER REVAK/  
Primary Examiner, Art Unit 2431

## Electronic Acknowledgement Receipt

<b>EFS ID:</b>	21070613
<b>Application Number:</b>	13740086
<b>International Application Number:</b>	
<b>Confirmation Number:</b>	7081
<b>Title of Invention:</b>	PERSONALIZED DIGITAL MEDIA ACCESS SYSTEM - PDMAS PART II
<b>First Named Inventor/Applicant Name:</b>	William Grecia
<b>Customer Number:</b>	70984
<b>Filer:</b>	William Grecia
<b>Filer Authorized By:</b>	
<b>Attorney Docket Number:</b>	
<b>Receipt Date:</b>	29-DEC-2014
<b>Filing Date:</b>	11-JAN-2013
<b>Time Stamp:</b>	10:00:02
<b>Application Type:</b>	Utility under 35 USC 111(a)

### Payment information:

Submitted with Payment	no
------------------------	----

### File Listing:

Document Number	Document Description	File Name	File Size(Bytes)/ Message Digest	Multi Part /.zip	Pages (if appl.)
1	Other Reference-Patent/App/Search documents	12766337.pdf	467242 <small>c1e96ddf09bed9ffbd5827ab29e8fe0e3157529f</small>	no	13

### Warnings:

### Information:

EWS-003556

**This Acknowledgement Receipt evidences receipt on the noted date by the USPTO of the indicated documents, characterized by the applicant, and including page counts, where applicable. It serves as evidence of receipt similar to a Post Card, as described in MPEP 503.**

**New Applications Under 35 U.S.C. 111**

**If a new application is being filed and the application includes the necessary components for a filing date (see 37 CFR 1.53(b)-(d) and MPEP 506), a Filing Receipt (37 CFR 1.54) will be issued in due course and the date shown on this Acknowledgement Receipt will establish the filing date of the application.**

**National Stage of an International Application under 35 U.S.C. 371**

**If a timely submission to enter the national stage of an international application is compliant with the conditions of 35 U.S.C. 371 and other applicable requirements a Form PCT/DO/EO/903 indicating acceptance of the application as a national stage submission under 35 U.S.C. 371 will be issued in addition to the Filing Receipt, in due course.**

**New International Application Filed with the USPTO as a Receiving Office**

**If a new international application is being filed and the international application includes the necessary components for an international filing date (see PCT Article 11 and MPEP 1810), a Notification of the International Application Number and of the International Filing Date (Form PCT/RO/105) will be issued in due course, subject to prescriptions concerning national security, and the date shown on this Acknowledgement Receipt will establish the international filing date of the application.**



UNITED STATES PATENT AND TRADEMARK OFFICE

UNITED STATES DEPARTMENT OF COMMERCE  
United States Patent and Trademark Office  
Address: COMMISSIONER FOR PATENTS  
P.O. Box 1450  
Alexandria, Virginia 22313-1450  
www.uspto.gov

APPLICATION NO.	FILING DATE	FIRST NAMED INVENTOR	ATTORNEY DOCKET NO.	CONFIRMATION NO.
13/312,184	12/06/2011	Leo Pedlow	113748-6071US	9904
103865	7590	12/19/2013	EXAMINER	
Procopio - SPE 525 B Street Suite 2200 San Diego, CA 92101			SMITHERS, MATTHEW	
			ART UNIT	PAPER NUMBER
			2437	
			NOTIFICATION DATE	DELIVERY MODE
			12/19/2013	ELECTRONIC

**Please find below and/or attached an Office communication concerning this application or proceeding.**

The time period for reply, if any, is set in the attached communication.

Notice of the Office communication was sent electronically on above-indicated "Notification Date" to the following e-mail address(es):

docketing@procopio.com



<b>Notice of Allowability</b>	<b>Application No.</b> 13/312,184	<b>Applicant(s)</b> PEDLOW ET AL.	
	<b>Examiner</b> MATTHEW SMITHERS	<b>Art Unit</b> 2437	<b>AIA (First Inventor to File) Status</b> No

**-- The MAILING DATE of this communication appears on the cover sheet with the correspondence address--**

All claims being allowable, PROSECUTION ON THE MERITS IS (OR REMAINS) CLOSED in this application. If not included herewith (or previously mailed), a Notice of Allowance (PTOL-85) or other appropriate communication will be mailed in due course. **THIS NOTICE OF ALLOWABILITY IS NOT A GRANT OF PATENT RIGHTS.** This application is subject to withdrawal from issue at the initiative of the Office or upon petition by the applicant. See 37 CFR 1.313 and MPEP 1308.

1.  This communication is responsive to an RCE filed October 18, 2013.  
 A declaration(s)/affidavit(s) under **37 CFR 1.130(b)** was/were filed on \_\_\_\_\_.
2.  An election was made by the applicant in response to a restriction requirement set forth during the interview on \_\_\_\_\_; the restriction requirement and election have been incorporated into this action.
3.  The allowed claim(s) is/are 7-22. As a result of the allowed claim(s), you may be eligible to benefit from the **Patent Prosecution Highway** program at a participating intellectual property office for the corresponding application. For more information, please see [http://www.uspto.gov/patents/init\\_events/oph/index.jsp](http://www.uspto.gov/patents/init_events/oph/index.jsp) or send an inquiry to [PPHfeedback@uspto.gov](mailto:PPHfeedback@uspto.gov).
4.  Acknowledgment is made of a claim for foreign priority under 35 U.S.C. § 119(a)-(d) or (f).

**Certified copies:**

- a)  All    b)  Some    \*c)  None of the:
1.  Certified copies of the priority documents have been received.
  2.  Certified copies of the priority documents have been received in Application No. \_\_\_\_\_.
  3.  Copies of the certified copies of the priority documents have been received in this national stage application from the International Bureau (PCT Rule 17.2(a)).

\* Certified copies not received: \_\_\_\_\_.

Applicant has THREE MONTHS FROM THE "MAILING DATE" of this communication to file a reply complying with the requirements noted below. Failure to timely comply will result in ABANDONMENT of this application.

**THIS THREE-MONTH PERIOD IS NOT EXTENDABLE.**

5.  CORRECTED DRAWINGS ( as "replacement sheets") must be submitted.  
 including changes required by the attached Examiner's Amendment / Comment or in the Office action of Paper No./Mail Date \_\_\_\_\_.  
**Identifying indicia such as the application number (see 37 CFR 1.84(c)) should be written on the drawings in the front (not the back) of each sheet. Replacement sheet(s) should be labeled as such in the header according to 37 CFR 1.121(d).**
6.  DEPOSIT OF and/or INFORMATION about the deposit of BIOLOGICAL MATERIAL must be submitted. Note the attached Examiner's comment regarding REQUIREMENT FOR THE DEPOSIT OF BIOLOGICAL MATERIAL.

**Attachment(s)**

- |  |  |
|--|--|
| 1. <input type="checkbox"/> Notice of References Cited (PTO-892)   | 5. <input type="checkbox"/> Examiner's Amendment/Comment                             |
| 2. <input checked="" type="checkbox"/> Information Disclosure Statements (PTO/SB/08),<br>Paper No./Mail Date <u>10/18/13</u> | 6. <input checked="" type="checkbox"/> Examiner's Statement of Reasons for Allowance |
| 3. <input type="checkbox"/> Examiner's Comment Regarding Requirement for Deposit<br>of Biological Material                   | 7. <input type="checkbox"/> Other _____.   |
| 4. <input type="checkbox"/> Interview Summary (PTO-413),<br>Paper No./Mail Date _____.                                       |  |

### **DETAILED ACTION**

The present application is being examined under the pre-AIA first to invent provisions.

#### ***Information Disclosure Statement***

The information disclosure statement filed October 18, 2013 has been placed in the application file and the information referred to therein has been considered as to the merits.

#### ***Allowable Subject Matter***

Claims 7-22 are allowed.

The following is an examiner's statement of reasons for allowance: The present invention is directed to a method and system for protecting digital rights content from unauthorized use and distribution. Independent claim 7 recites the uniquely distinct features of "receiving and validating a certificate from the client device; enabling the client device to log into and communicate with a server using a secure protocol to establish a private relationship between the client device and the server; transmitting a resource identifier to the client device using the secure protocol when the private relationship is established; receiving an encryption key from a service provider; generating a hash value and a private key associated with the encryption key; encrypting the resource identifier using the encryption key and the hash value; and encrypting the hash value using the private key". Independent claims 10 and 16 recite

Art Unit: 2437

the uniquely distinct features of "receive and validate a certificate from the client device; enable the client device to log into and communicate with a server using a secure protocol to establish a private relationship between the client device and the server; and transmit a resource identifier to the client device using the secure protocol when the private relationship is established: wherein the private relationship is used to periodically refresh the resource identifier to prevent unauthorized access to the contents and services". Newly submitted prior art patents, US 8,533,860, US 8,543,660, and US 8,402,555, were considered, however none, taking singularly or in combination, appear to disclose the claimed invention in the instant application. The closest prior art reference, Grecia (US 8,533,860), discloses a personalized digital rights management system in which a particular user is allowed access to digital assets based on the branding of metadata associated with the encrypted digital asset. The branded metadata is created with the particular user's membership token and the electronic identification reference received from the user (see column 8, lines 9-30 and Figure 6). In the Grecia reference, the communications console submits a branding request that includes the particular user's membership verification token. Next, the membership verification token is authenticated and if successful a connection is established with the communications console. Finally, an **electronic identification reference** is transmitted **from** the communications console **to** the branding module where the branding module **writes the membership verification token and the electronic ID reference into the metadata** of the encrypted digital media. In the instant application, a server transmits a resource identifier **to** the client device after it has validated a certificate from the client

Art Unit: 2437

and established a private relationship with the client device. The instant application differs from the Grecia reference in that the Grecia reference requires the electronic identification reference (assuming the electronic identification reference is equivalent to the claimed resource identifier) to be transmitted **from** the client device **to** the server device. This is an important difference because a members access to encrypted digital media is tied to the data (membership verification token and electronic identification reference) branded into the metadata associated with the encrypted digital media. The electronic identification reference is not stored in the encrypted digital media nor is it encrypted with a service provider's key and hash value generated by the streaming server.

Further, even if one was to assume the claimed resource identifier is equivalent to Grecia's media items (see column 8, lines 31-42 and Figure 7), then the Grecia reference would still fail because a members access to the encrypted digital media is tied to the data (membership verification token and electronic identification reference) branded into the metadata associated with the encrypted digital media and not written into the encrypted digital media. As taught in the above referenced section of Grecia, only the membership verification token is required for decrypting the encrypted media. This is different from encrypting the digital media with a service provider's key and a hash value generated at the streaming server in which both the key and hash value are subsequently needed to decrypt the resource identifier to facilitate access to the digital media.

Lastly, the Grecia patent makes it clear that it is a front-end system for authorizing access to the digital files (see column 5, lines 33-39 and claim 9) and that its intent is to provide a **metadata writable DRM system** that allows a user unlimited interoperability between its member devices and sharing partners for an infinite time frame (see column 2, line 63 to column 3, line 7).

Any comments considered necessary by applicant must be submitted no later than the payment of the issue fee and, to avoid processing delays, should preferably accompany the issue fee. Such submissions should be clearly labeled "Comments on Statement of Reasons for Allowance."

### ***Conclusion***

Any inquiry concerning this communication or earlier communications from the examiner should be directed to MATTHEW SMITHERS whose telephone number is (571)272-3876. The examiner can normally be reached on Monday-Friday (8:00-4:30) EST.

If attempts to reach the examiner by telephone are unsuccessful, the examiner's supervisor, Eleni A. Shiferaw can be reached on (571) 272-3867. The fax phone number for the organization where this application or proceeding is assigned is 571-273-8300.

Art Unit: 2437

Information regarding the status of an application may be obtained from the Patent Application Information Retrieval (PAIR) system. Status information for published applications may be obtained from either Private PAIR or Public PAIR. Status information for unpublished applications is available through Private PAIR only. For more information about the PAIR system, see <http://pair-direct.uspto.gov>. Should you have questions on access to the Private PAIR system, contact the Electronic Business Center (EBC) at 866-217-9197 (toll-free). If you would like assistance from a USPTO Customer Service Representative or access to the automated information system, call 800-786-9199 (IN USA OR CANADA) or 571-272-1000.

/MATTHEW SMITHERS/  
Primary Examiner, Art Unit 2437

## Electronic Acknowledgement Receipt

<b>EFS ID:</b>	21070633
<b>Application Number:</b>	13740086
<b>International Application Number:</b>	
<b>Confirmation Number:</b>	7081
<b>Title of Invention:</b>	PERSONALIZED DIGITAL MEDIA ACCESS SYSTEM - PDMAS PART II
<b>First Named Inventor/Applicant Name:</b>	William Grecia
<b>Customer Number:</b>	70984
<b>Filer:</b>	William Grecia
<b>Filer Authorized By:</b>	
<b>Attorney Docket Number:</b>	
<b>Receipt Date:</b>	29-DEC-2014
<b>Filing Date:</b>	11-JAN-2013
<b>Time Stamp:</b>	10:03:00
<b>Application Type:</b>	Utility under 35 USC 111(a)

### Payment information:

Submitted with Payment	no
------------------------	----

### File Listing:

Document Number	Document Description	File Name	File Size(Bytes)/ Message Digest	Multi Part /.zip	Pages (if appl.)
1	Other Reference-Patent/App/Search documents	13312184.pdf	238452 <small>a641172818599d132bbe1ea79/d68bd7865f5247</small>	no	7

### Warnings:

### Information:

EWS-003565

**This Acknowledgement Receipt evidences receipt on the noted date by the USPTO of the indicated documents, characterized by the applicant, and including page counts, where applicable. It serves as evidence of receipt similar to a Post Card, as described in MPEP 503.**

**New Applications Under 35 U.S.C. 111**

**If a new application is being filed and the application includes the necessary components for a filing date (see 37 CFR 1.53(b)-(d) and MPEP 506), a Filing Receipt (37 CFR 1.54) will be issued in due course and the date shown on this Acknowledgement Receipt will establish the filing date of the application.**

**National Stage of an International Application under 35 U.S.C. 371**

**If a timely submission to enter the national stage of an international application is compliant with the conditions of 35 U.S.C. 371 and other applicable requirements a Form PCT/DO/EO/903 indicating acceptance of the application as a national stage submission under 35 U.S.C. 371 will be issued in addition to the Filing Receipt, in due course.**

**New International Application Filed with the USPTO as a Receiving Office**

**If a new international application is being filed and the international application includes the necessary components for an international filing date (see PCT Article 11 and MPEP 1810), a Notification of the International Application Number and of the International Filing Date (Form PCT/RO/105) will be issued in due course, subject to prescriptions concerning national security, and the date shown on this Acknowledgement Receipt will establish the international filing date of the application.**



## Electronic Acknowledgement Receipt

<b>EFS ID:</b>	20954145
<b>Application Number:</b>	13740086
<b>International Application Number:</b>	
<b>Confirmation Number:</b>	7081
<b>Title of Invention:</b>	PERSONALIZED DIGITAL MEDIA ACCESS SYSTEM - PDMAS PART II
<b>First Named Inventor/Applicant Name:</b>	William Grecia
<b>Customer Number:</b>	70984
<b>Filer:</b>	William Grecia
<b>Filer Authorized By:</b>	
<b>Attorney Docket Number:</b>	
<b>Receipt Date:</b>	12-DEC-2014
<b>Filing Date:</b>	11-JAN-2013
<b>Time Stamp:</b>	22:19:57
<b>Application Type:</b>	Utility under 35 USC 111(a)

### Payment information:

Submitted with Payment	no
------------------------	----

### File Listing:

Document Number	Document Description	File Name	File Size(Bytes)/ Message Digest	Multi Part /.zip	Pages (if appl.)
1	Miscellaneous Incoming Letter	13312184.pdf	238452 <small>a641172818599d132bbe1ea79/d68bd7865f5247</small>	no	7

### Warnings:

### Information:

EWS-003567

**This Acknowledgement Receipt evidences receipt on the noted date by the USPTO of the indicated documents, characterized by the applicant, and including page counts, where applicable. It serves as evidence of receipt similar to a Post Card, as described in MPEP 503.**

**New Applications Under 35 U.S.C. 111**

**If a new application is being filed and the application includes the necessary components for a filing date (see 37 CFR 1.53(b)-(d) and MPEP 506), a Filing Receipt (37 CFR 1.54) will be issued in due course and the date shown on this Acknowledgement Receipt will establish the filing date of the application.**

**National Stage of an International Application under 35 U.S.C. 371**

**If a timely submission to enter the national stage of an international application is compliant with the conditions of 35 U.S.C. 371 and other applicable requirements a Form PCT/DO/EO/903 indicating acceptance of the application as a national stage submission under 35 U.S.C. 371 will be issued in addition to the Filing Receipt, in due course.**

**New International Application Filed with the USPTO as a Receiving Office**

**If a new international application is being filed and the international application includes the necessary components for an international filing date (see PCT Article 11 and MPEP 1810), a Notification of the International Application Number and of the International Filing Date (Form PCT/RO/105) will be issued in due course, subject to prescriptions concerning national security, and the date shown on this Acknowledgement Receipt will establish the international filing date of the application.**

AO 120 (Rev. 2/99)

TO: <b>Mail Stop 8</b> <b>Director of the U.S. Patent &amp; Trademark Office</b> P.O. Box 1450 Alexandria, VA 22313-1450	<b>REPORT ON THE                  FILING OR DETERMINATION OF AN                  ACTION REGARDING A PATENT OR                  TRADEMARK</b>
---	--

In Compliance with 35 § 290 and/or 15 U.S.C. § 1116 you are hereby advised that a court action has been filed in the U.S. District Court Northern District California on the  Patents or  Trademarks:

DOCKET NO. CV 14-01220 JCS	DATE FILED 3/14/14	U.S. DISTRICT COURT 450 Golden Gate Avenue, 16 <sup>th</sup> Floor, San Francisco CA 94102
PLAINTIFF WILLIAM GRECIA		DEFENDANT VUDU INC ET AL
PATENT OR TRADEMARK NO.	DATE OF PATENT OR TRADEMARK	HOLDER OF PATENT OR TRADEMARK
1 <b>8,533,960</b>		***see Attach complaint***
2		
3		
4		
5		

In the above—entitled case, the following patent(s) have been included:

DATE INCLUDED	INCLUDED BY <input checked="" type="checkbox"/> Amendment <input type="checkbox"/> Answer <input type="checkbox"/> Cross Bill <input type="checkbox"/> Other Pleading		
PATENT OR TRADEMARK NO.	DATE OF PATENT OR TRADEMARK	HOLDER OF PATENT OR TRADEMARK	
1		***see Second Amended Complaint***	
2		filed 10/3/2014	
3			
4			
5			

In the above—entitled case, the following decision has been rendered or judgement issued:

DECISION/JUDGEMENT
--------------------

CLERK  Richard W. Wieking	(BY) DEPUTY CLERK  Gina Augustine	DATE  March 15, 2014
---------------------------------	---	----------------------------

Copy 1—Upon initiation of action, mail this copy to Commissioner    Copy 3—Upon termination of action, mail this copy to Commissioner  
 Copy 2—Upon filing document adding patent(s), mail this copy to Commissioner    Copy 4—Case file copy

EWS-003569

*Notification of Loss of Small Entity Status*

Applicant on July 10, 2014 signed a licensing agreement with an entity that would not qualify for Small Entity Status, thus passing through the non-qualification as per PTO rules. Applicant will pay full entity fees from this said date of entity change.

Respectfully

/William Grecia/  
William Grecia  
Applicant Pro Se

## Electronic Acknowledgement Receipt

<b>EFS ID:</b>	19591974
<b>Application Number:</b>	13740086
<b>International Application Number:</b>	
<b>Confirmation Number:</b>	7081
<b>Title of Invention:</b>	PERSONALIZED DIGITAL MEDIA ACCESS SYSTEM - PDMAS PART II
<b>First Named Inventor/Applicant Name:</b>	William Grecia
<b>Customer Number:</b>	70984
<b>Filer:</b>	William Grecia
<b>Filer Authorized By:</b>	
<b>Attorney Docket Number:</b>	
<b>Receipt Date:</b>	16-JUL-2014
<b>Filing Date:</b>	11-JAN-2013
<b>Time Stamp:</b>	10:45:40
<b>Application Type:</b>	Utility under 35 USC 111(a)

### Payment information:

Submitted with Payment	no
------------------------	----

### File Listing:

Document Number	Document Description	File Name	File Size(Bytes)/ Message Digest	Multi Part /.zip	Pages (if appl.)
1	Notification of loss of entitlement to small entity status	lossentity.pdf	194206 <small>d5b36f31cf5ca009e896c0755208cc8fc278ae0f</small>	no	1

### Warnings:

### Information:

EWS-003571

**This Acknowledgement Receipt evidences receipt on the noted date by the USPTO of the indicated documents, characterized by the applicant, and including page counts, where applicable. It serves as evidence of receipt similar to a Post Card, as described in MPEP 503.**

**New Applications Under 35 U.S.C. 111**

**If a new application is being filed and the application includes the necessary components for a filing date (see 37 CFR 1.53(b)-(d) and MPEP 506), a Filing Receipt (37 CFR 1.54) will be issued in due course and the date shown on this Acknowledgement Receipt will establish the filing date of the application.**

**National Stage of an International Application under 35 U.S.C. 371**

**If a timely submission to enter the national stage of an international application is compliant with the conditions of 35 U.S.C. 371 and other applicable requirements a Form PCT/DO/EO/903 indicating acceptance of the application as a national stage submission under 35 U.S.C. 371 will be issued in addition to the Filing Receipt, in due course.**

**New International Application Filed with the USPTO as a Receiving Office**

**If a new international application is being filed and the international application includes the necessary components for an international filing date (see PCT Article 11 and MPEP 1810), a Notification of the International Application Number and of the International Filing Date (Form PCT/RO/105) will be issued in due course, subject to prescriptions concerning national security, and the date shown on this Acknowledgement Receipt will establish the international filing date of the application.**

## Electronic Acknowledgement Receipt

<b>EFS ID:</b>	19321439
<b>Application Number:</b>	13740086
<b>International Application Number:</b>	
<b>Confirmation Number:</b>	7081
<b>Title of Invention:</b>	PERSONALIZED DIGITAL MEDIA ACCESS SYSTEM - PDMAS PART II
<b>First Named Inventor/Applicant Name:</b>	William Grecia
<b>Customer Number:</b>	70984
<b>Filer:</b>	William Grecia
<b>Filer Authorized By:</b>	
<b>Attorney Docket Number:</b>	
<b>Receipt Date:</b>	16-JUN-2014
<b>Filing Date:</b>	11-JAN-2013
<b>Time Stamp:</b>	22:12:23
<b>Application Type:</b>	Utility under 35 USC 111(a)

### Payment information:

Submitted with Payment	no
------------------------	----

### File Listing:

Document Number	Document Description	File Name	File Size(Bytes)/ Message Digest	Multi Part /.zip	Pages (if appl.)
1	Miscellaneous Incoming Letter	patentID.pdf	2492559 <small>108f477b051dfe42c896319b398e87316f74 a6e5</small>	no	3

### Warnings:

### Information:

EWS-003573

**This Acknowledgement Receipt evidences receipt on the noted date by the USPTO of the indicated documents, characterized by the applicant, and including page counts, where applicable. It serves as evidence of receipt similar to a Post Card, as described in MPEP 503.**

**New Applications Under 35 U.S.C. 111**

**If a new application is being filed and the application includes the necessary components for a filing date (see 37 CFR 1.53(b)-(d) and MPEP 506), a Filing Receipt (37 CFR 1.54) will be issued in due course and the date shown on this Acknowledgement Receipt will establish the filing date of the application.**

**National Stage of an International Application under 35 U.S.C. 371**

**If a timely submission to enter the national stage of an international application is compliant with the conditions of 35 U.S.C. 371 and other applicable requirements a Form PCT/DO/EO/903 indicating acceptance of the application as a national stage submission under 35 U.S.C. 371 will be issued in addition to the Filing Receipt, in due course.**

**New International Application Filed with the USPTO as a Receiving Office**

**If a new international application is being filed and the international application includes the necessary components for an international filing date (see PCT Article 11 and MPEP 1810), a Notification of the International Application Number and of the International Filing Date (Form PCT/RO/105) will be issued in due course, subject to prescriptions concerning national security, and the date shown on this Acknowledgement Receipt will establish the international filing date of the application.**





This patent was invented by William Grecia.

This document can only be submitted by the owner of this patent, using the secure certificate administered by the USPTO at USPTO.gov

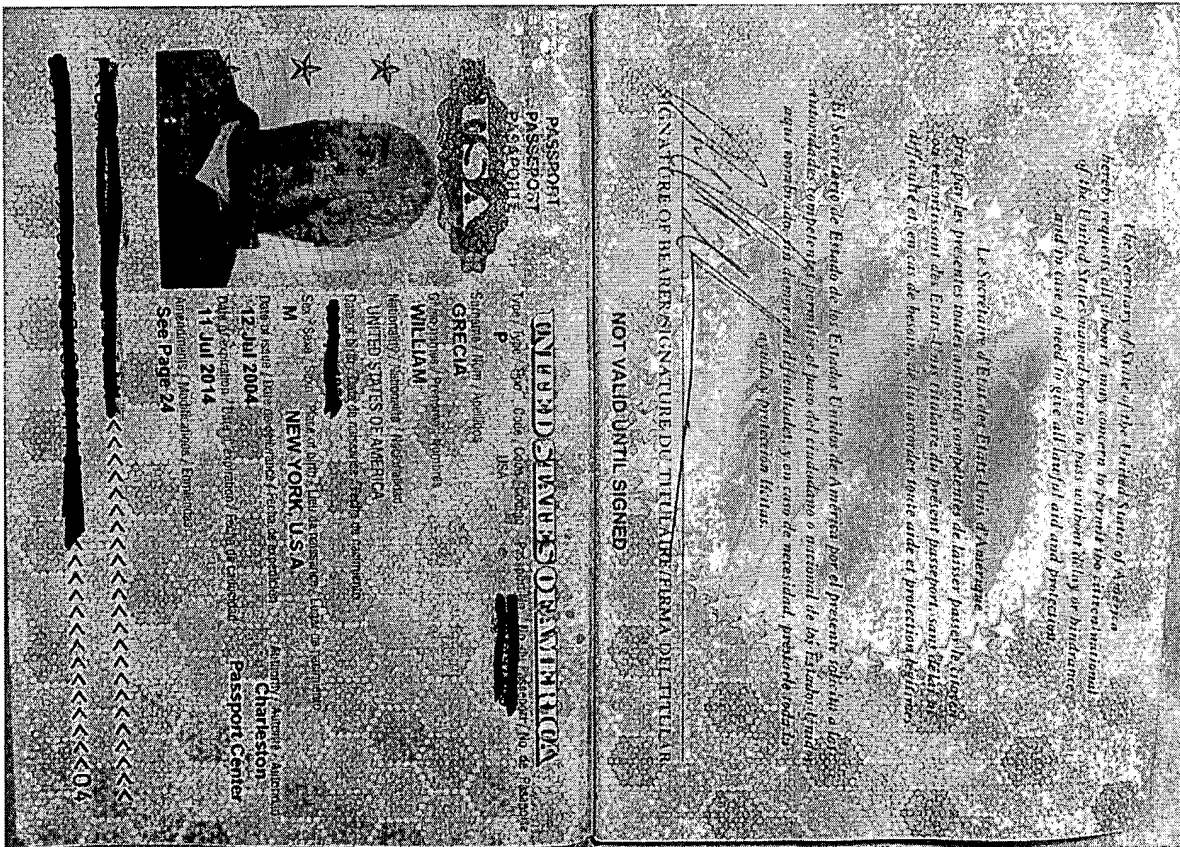

United States Passport of Inventor William Grecia

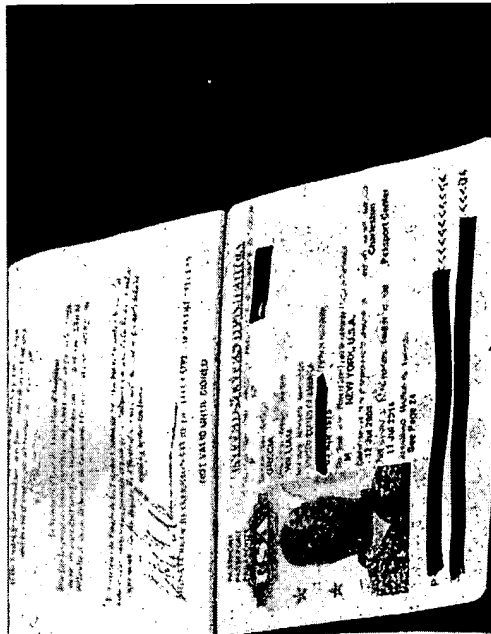

**MAINTENANCE FEE NOTICE**

This application for this patent was filed on or after December 12, 1980, maintenance fees are due every three years and six months, and eleven years and six months after the date of this grant, or within a grace period of six months thereafter. The amount, number and timing of the maintenance fees required may be changed by law or regulation. Unless payment of the applicable maintenance fee is received in the United States Patent and Trademark Office before the date for fee is due or within a grace period of six months thereafter, the patent will expire at the end of such grace period.

**PATENT TERM NOTICE**

This application for this patent was filed on or after June 8, 1995, the term of this patent begins on the date on which this patent issues and ends twenty years from the date of the application or, if the application contains a specific reference to an earlier filed application or applications under 35 U.S.C. 120, 121, or 365(c), twenty years from the filing date of the earliest such application ("the twenty-year term"), as to the payment of maintenance fees as provided by 35 U.S.C. 41(h), and any term as provided by 35 U.S.C. 154(b) or 156 or any disclaimer under 35 U.S.C.

This application was filed prior to June 8, 1995, the term of this patent begins on the date on which this patent issues and ends on the later of seventeen years from the date of this patent or the twenty-year term set forth above for patents resulting from applications filed on or after June 8, 1995, subject to the payment of maintenance fees provided by 35 U.S.C. 41(h) and any extension as provided by 35 U.S.C. 156 or 157, 35 U.S.C. 253.

**(12) United States Patent**  
Grecia

(19) Patent No.: **US 8,533,860 B1**  
(45) Date of Patent: **\*Sep. 10, 2013**

(54) **PERSONALIZED DIGITAL MEDIA ACCESS SYSTEM—POMAS PART II**  
(71) Applicant: **William Grecia, Brooklyn, NY (US)**  
(72) Inventor: **William Grecia, Brooklyn, NY (US)**  
(\* ) **Notice:** Subject to any disclaimer, the term of this patent is extended or adjusted under 35 U.S.C. 154(b) by 0 days.  
This patent is subject to a terminal disclaimer.

2012/0041129 A1 2/2012 Hufschmidt  
2012/0079999 A1 3/2012 Fung  
2012/0079136 A1 3/2012 Fung  
2012/0079776 A1 3/2012 Fung  
2012/0079606 A1 3/2012 Fung  
2012/0082877 A1 4/2012 Dorsey  
2012/0095906 A1 4/2012 Dorsey  
2012/0095916 A1 4/2012 Dorsey  
2012/0103643 A1 5/2012 Dorsey  
2012/0107227 A1 6/2012 Dorsey  
2012/0106633 A1 6/2012 Van Deuren  
2012/0171333 A1 7/2012 Dorsey  
2012/0113431 A1 7/2012 Kichen  
2012/0171325 A1 7/2012 Reager  
2012/0191553 A1 7/2012 Goffe  
2012/0254140 A1 8/2012 Vichayavong  
2012/0255013 A1 8/2012 Dwyer  
2012/0260706 A1 8/2012 Dwyer  
2012/0286741 A1 10/2012 Dwyer  
2012/0282823 A1 12/2012 Ho  
2013/0070292 A1 6/2013 Ho

(21) Appl. No.: **13740,066**  
(22) Filed: **Jan. 11, 2013**  
(51) Int. Cl.: **H04L 29/06 (2006.01)**  
(52) U.S. Cl.: **USPC 726/29, 72/528; 713/185; 705/51**  
(56) Field of Classification Search: **None**  
See application file for complete search history.

**OTHER PUBLICATIONS**

Co-pending U.S. Appl. No. 13/987,517 document reference Jan. 7, 2013 Examiner Interview summary (PTOL-4178).  
Co-pending U.S. Appl. No. 13/971,117 document reference Oct. 26, 2012 Advisory Action (PTOL-3973).  
Co-pending U.S. Appl. 13/977,517 document reference Nov. 26, 2012 Final Rejection.

(48) **References Cited**  
**U.S. PATENT DOCUMENTS**  
7,254,235 B2 4/2007 Hufschmidt et al.  
7,343,014 B2 3/2008 Sato et al.  
7,285,850 B1\* 4/2009 Winicki, et al. 718/176  
8,283,143 B2 3/2013 Zacherberg  
8,282,996 B1 10/2013 Zacherberg  
2009/0193911 A1 8/2009 Lee et al.  
2009/0196243 A1 8/2009 Lieberman et al.  
2009/0208341 A1 9/2009 Layton  
2010/0101979 A1 4/2010 Nease et al.  
2011/0235693 A1 9/2011 Ahmad  
2011/0262157 A1 10/2011 Klyber  
2011/0262346 A1 11/2011 Saha et al. 703/26.1  
2011/0311398 A1 12/2011 Singhal  
2011/0328143 A1 12/2011 Tsvetanov

**Primary Examiner** — Jung Kim  
**Assistant Examiner** — Yi Tian

**ABSTRACT**  
The invention is an apparatus that facilitates access to a data source to accept verification and authentication from any number using at least one token and at least one reference. The at least one reference could be a device serial number, a networking MAC address, or a membership ID reference from a web service. Access to the data source is also managed with a plurality of secondary members.

30 Claims, 7 Drawing Sheets

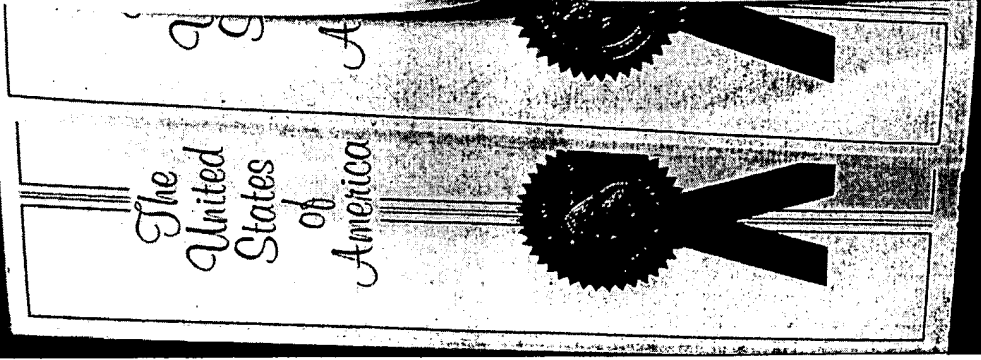
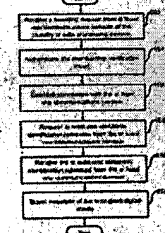

US Patent 8,533,860 with valid Passport and Driver License of William Grecia



## **This is a technological patent.**

The technological scope of the claims are demonstrated, but not limited to, technological examples expressed and attached herein.

Relevant USPTO advanced patent and patent application search formula:

aclm/api and aclm/cloud and aclm/rights  
aclm/api and aclm/cloud and aclm/right

*Date: May 20, 2010*

Vic Gundotra, the Google SVP of Engineering

Source: <http://youtu.be/IY3U2GXhz44?t=31m10s>

Statements: "I want to go a little bit beyond Froyo and show you a **sneak peek**" - 31:25 "**Unlike anything you've ever seen before.**"

*Date: June 6, 2011*

Steve Jobs, CEO Apple

Source: <http://youtu.be/gfj7UgCMsqs?t=1h20m19s>

Statements: We've got a great solution for this problem, and we think this solution is **our next big insight**.

Apple's iCloud patent application wherein the examiner recognizes this patent's disclosure as prior art in a 102(e) rejection: 12/766,337

*Date: August 31, 2011*

Kaz Hirai, Sony executive and Sony UK Blog

Source: <http://uk.playstation.com/introducingsonyentertainmentnetwork/>

Statements: Sony announces the Sony Entertainment Network (SEN) - "**a new platform** - Sony Entertainment Network" and "services will be **realigned** under Sony Entertainment Network"

Sony's SEN patent application wherein the examiner recognizes this patent's disclosure as the closest prior art: 13/312,184 – *Applicant submits that the examiner of 13/312,184 provides an inaccurate analysis of this patent's disclosure as the word "transmit" or any variation thereof is not found within the specification of this patent.*

**This document is submitted to support a default defense against frivolous CBM and reexamination request as a strategic tool by defendants to force a "stay" in possible associated court matters.**

**Technological examples continue on page 2 of this document.**

# U.S. Patent 8,533,860: Google Play

Claim 1	Technological Example
<p>A method for authorizing access to digital content using a cloud system, the cloud system comprising connected modules in operation as one or more of a cloud computing or a cloud storage in connection with devices and users, wherein the digital content is at least one of encrypted or not encrypted, the method facilitating access rights between a plurality of data processing devices, the method comprising:</p>	<p>Source: <a href="https://play.google.com/intl/en-US_us/about/overview/index.html">https://play.google.com/intl/en-US_us/about/overview/index.html</a></p>

**Claim 1**

**Technological Example**

Reposter articles:

"You haven't accessed the Google Play Store app on your device with this email account."

Add an account to use Google Play on your device

You will receive the error "You haven't accessed the Google Play Store app (the white shopping bag app icon) on your device with this email account. Learn More." on the Google Play website if:

Use a Google Apps account

- Your phone or tablet isn't a supported device. There is no way to manually add your phone or tablet to the device list on play.google.com, and you will not be able to use the Google Play website.

"You haven't accessed the Google Play Store app on your device with this email account."

- You are trying to use the Google Play website before using the Google Play Store app on your device. It may take several minutes after using the Google Play Store app on your device for that phone or tablet to show up on play.google.com. If you don't have the Google Play Store app pre-installed on your device, contact your carrier or manufacturer for further assistance.

Transfer music files via USB

Source: <https://support.google.com/googleplay/answer/1141080>



Source: <https://play.google.com/apps>

**Manage your devices**

You can stream music in your library to any device or computer via a browser on which you're signed in. You can also download music in your library to any authorized device or computer. You can authorize up to a total of ten devices or computers at any one time. At this time, only two Google accounts per computer can be used to add music with the Google Play Music Manager.

Music from your library cannot be played simultaneously on more than one device. If you're currently playing music, you'll need to stop playback in order to play your music on another device.

Source: <https://support.google.com/googleplay/answer/1230356?hl=en>

Claim 1	Technological Example
<p>receiving a digital content access request from at least one communications console of the plurality of data processing devices, the access request being a read or write request of metadata of the digital content, wherein the read or write request of metadata is performed in connection with a combination of at least one device and the cloud system, the request comprising a verification token provided by a first user corresponding to the digital content, wherein the verification token is one or more of a password, e-mail address, payment system, credit card, authorize ready device, rights token, or one or more redeemable instruments of trade;</p>	 <p>Source: Motorola XOOM Tablet</p>

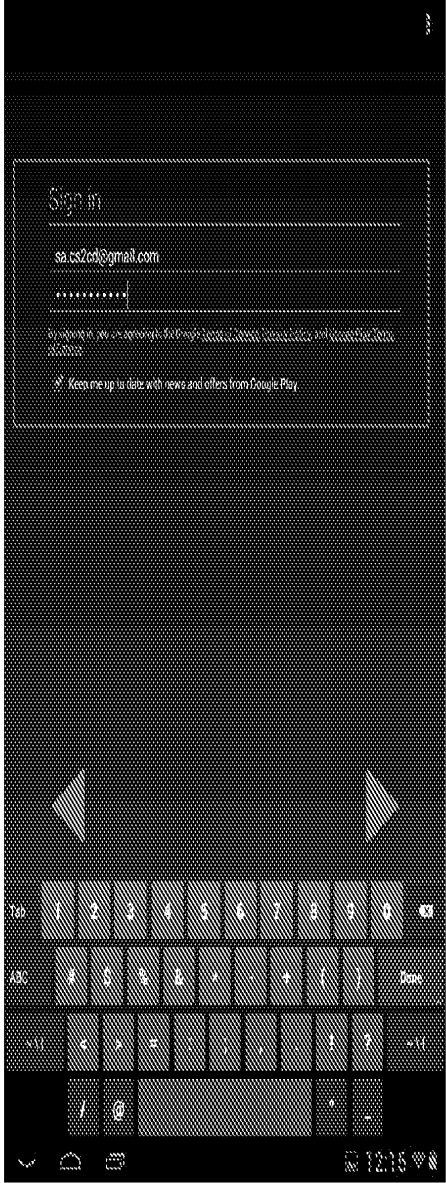
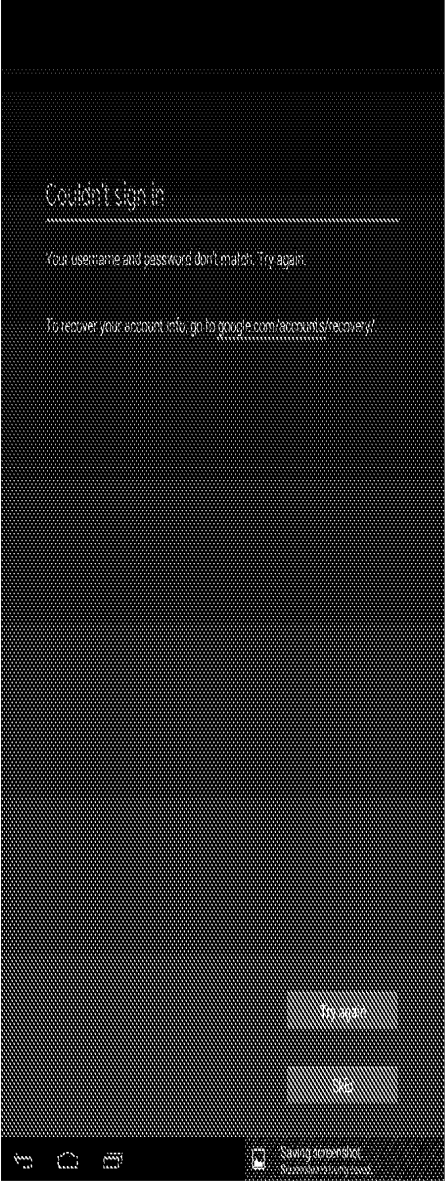
Claim 1	Technological Example
<p>authenticating the verification token;</p>	<div style="display: flex; justify-content: space-around;">   </div> <p>Source: Motorola XOOM Tablet</p> <h3>Username &amp; password errors</h3> <p>The most common cause of <u>username/password</u> mismatch errors when trying to access Google Play is that your account uses <u>2-step verification</u>, but you haven't set up an application-specific password for use on your <i>Android</i> phone or tablet.</p> <p>Source: <a href="https://support.google.com/googleplay/answer/2651409?hl=en">https://support.google.com/googleplay/answer/2651409?hl=en</a></p>

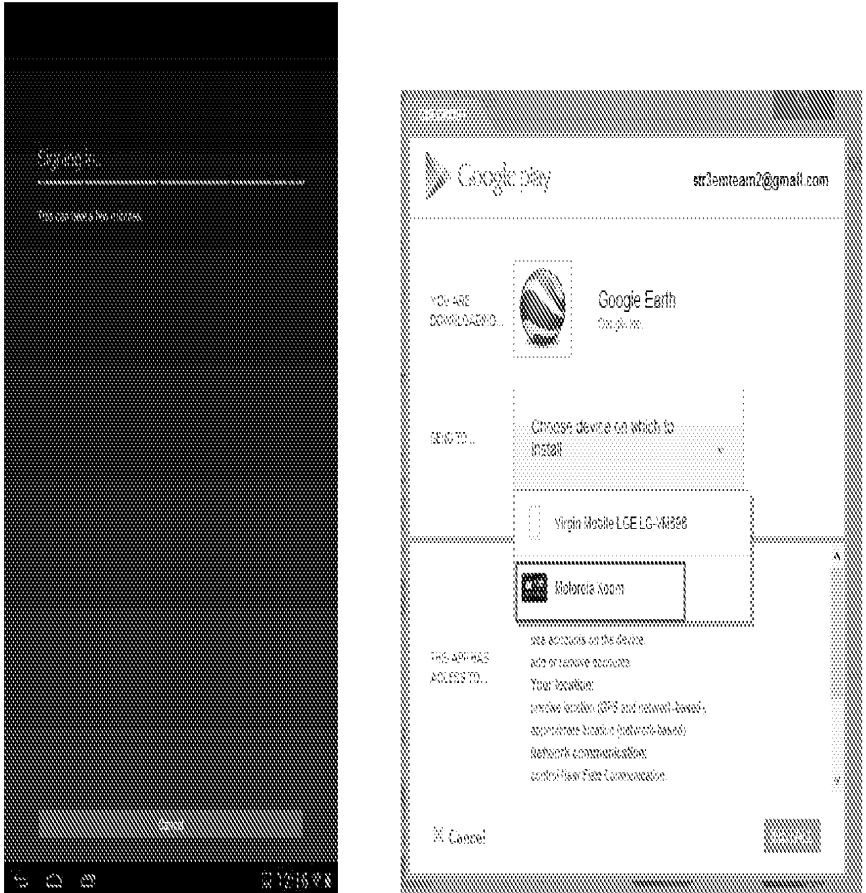
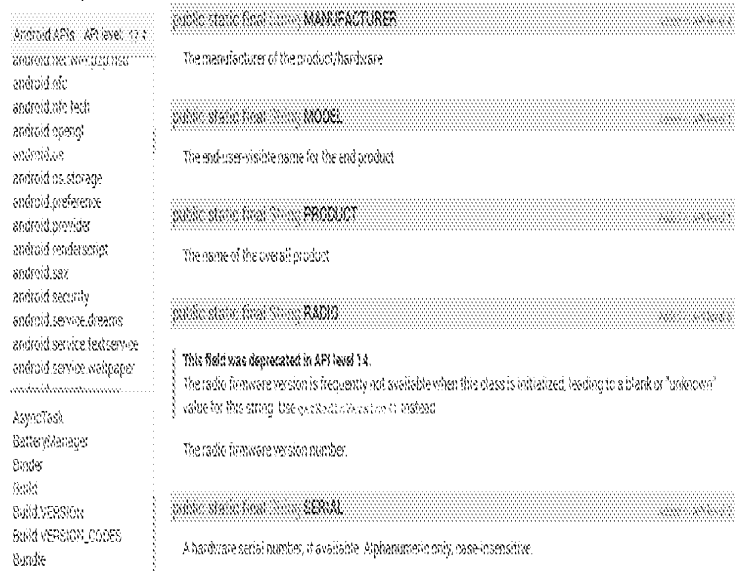

Claim 1	Technological Example
<p>establishing a connection with the at least one communications console, wherein the communications console is a combination of a graphic user interface (GUI) and an Application Programmable Interface (API) wherein the API is related to a verified web service, the web service capable of facilitating a two way data exchange session to complete a verification process wherein the data exchange session comprises at least one identification reference;</p>	<div data-bbox="354 184 673 1029" data-label="Image"> </div> <div data-bbox="714 184 1034 1029" data-label="Image"> </div> <div data-bbox="354 1050 714 1732" data-label="Text"> <p><b>The Google Play services APK</b></p> <p>The Google Play services APK contains the individual Google services and runs as a background service in the Android OS. You interact with the background service through the client library and the service carries out the actions on your behalf. An easy-to-use authorization flow is also provided to gain access to the each Google service, which provides consistency for both you and your users.</p> <p>The Google Play services APK is delivered through the Google Play Store, so updates to the services are not dependent on carrier or OEM system image updates. In general, devices running Android 2.2 (Froyo) or later and have the Google Play Store app installed receive updates within a few days. This allows you to use the newest APIs in Google Play services and reach most of the devices in the Android ecosystem (devices older than Android 2.2 or devices without the Google Play Store app are not supported).</p> </div> <div data-bbox="714 1050 1088 1732" data-label="Diagram"> <p>The diagram illustrates the interaction between a user's application and the Google Play services. On the left, a smartphone screen shows a 'Client Library' and 'Your App'. Below the screen, the 'Google Play services APK' is shown. On the right, the 'Google Play Store' is represented by a shopping bag icon with a play button. An arrow points from the 'Google Play Store' to an 'Updates' box, which then has an arrow pointing to the 'Google Play services APK' on the phone. A text box at the bottom states: 'The Google Play services APK on user devices receives regular updates for new APIs, features, and bug fixes.'</p> </div> <div data-bbox="354 1753 982 1795" data-label="Text"> <p>Source: <a href="http://developer.android.com/google/play-services/index.html">http://developer.android.com/google/play-services/index.html</a></p> </div>

Claim 1	Technological Example
<p>requesting the at least one identification reference from the at least one communications console, wherein the identification reference comprises one or more of a verified web service account identifier, letter, number, rights token, e-mail, password, access time, serial number, address, manufacturer identification, checksum, operating system version, browser version, credential, cookie, or key;</p>	 <p>API automation in Google Play setup</p> <p>Source: Motorola Xoom screenshot</p>
<p>receiving the at least one identification reference from the at least one communications console; and</p>	 <p>Android device API documentation. Source: <a href="http://developer.android.com/reference/android/os/Build.html#MANUFACTURER">http://developer.android.com/reference/android/os/Build.html#MANUFACTURER</a></p>

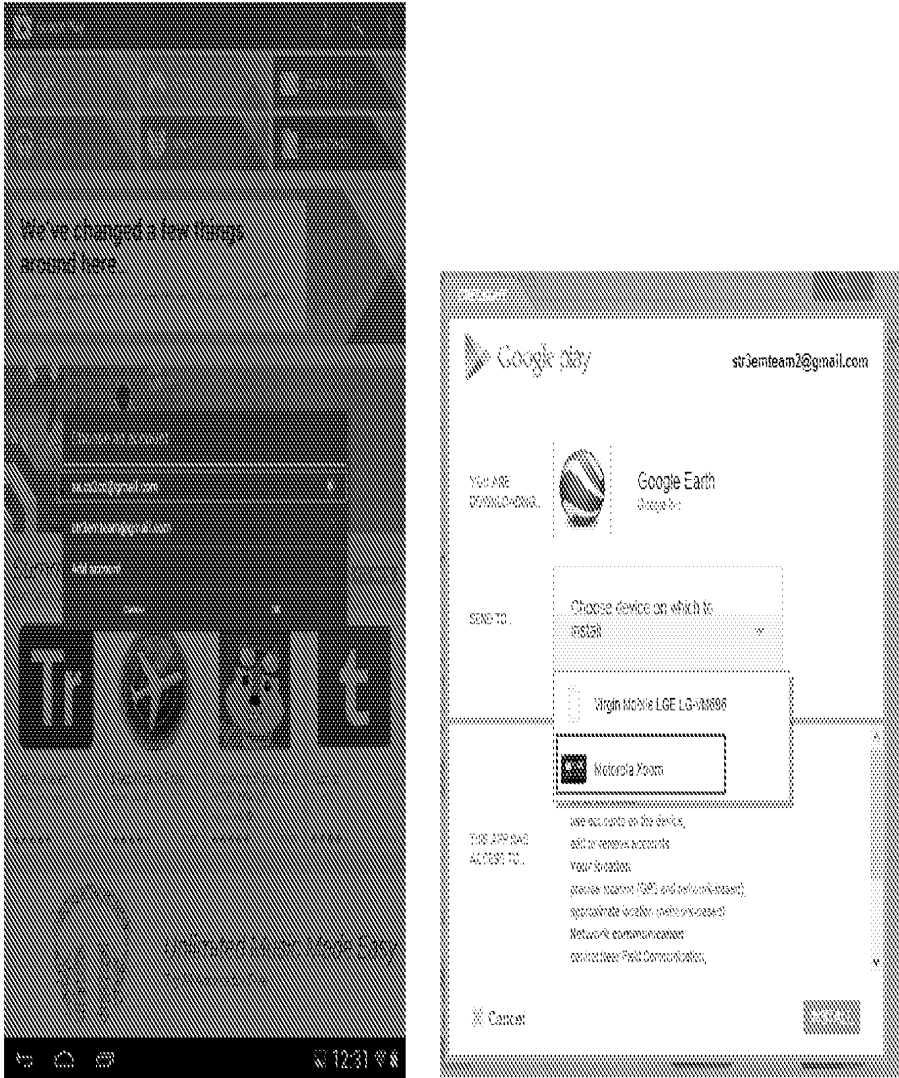
Claim 1	Technological Example
<p>writing at least one of the verification token or the identification reference into the metadata.</p>	 <p>The left screenshot shows an email interface with a message from 'android@play.com' and a 'Google Play' logo. The right screenshot shows the Google Play app interface for Google Earth, displaying the user's device as 'Virgin Mobile LGE LG-M896' and a 'Victoria Power' account.</p>

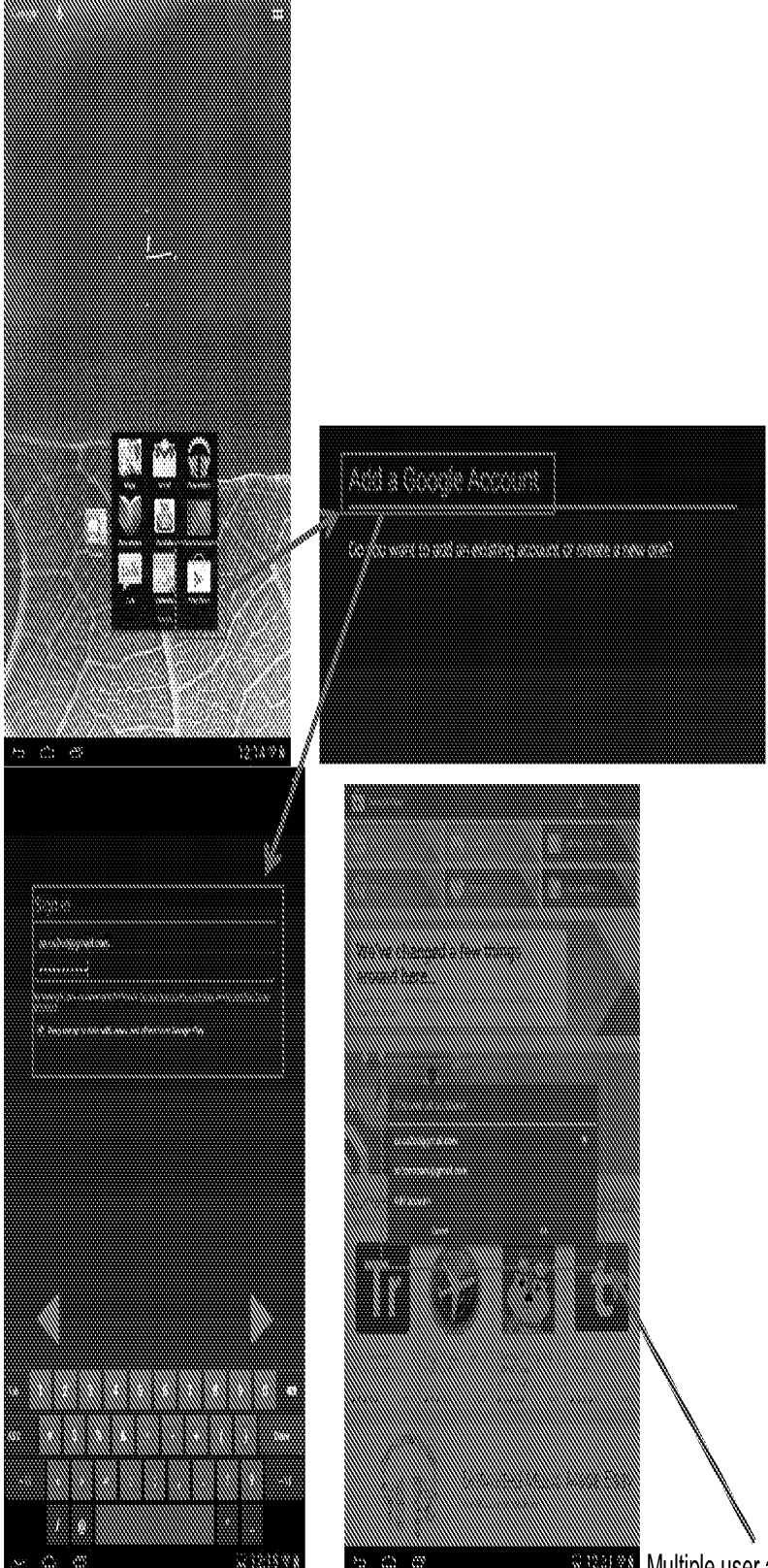
Claim 2	Technological Example
<p>The method according to claim 1, wherein the access request being a request from the first user through a data processing device of the plurality of data processing devices; or wherein the access request being a request from one or more secondary users in network to the first user; wherein said secondary users are validated by a membership web service.</p>	 <p>Source: Motorola XOOM Tablet</p> <p>Multiple user account</p>

**Claim 3**

**Technological Example**

The method according to claim 2, wherein the metadata comprises one or more of a software or contents of a web page.

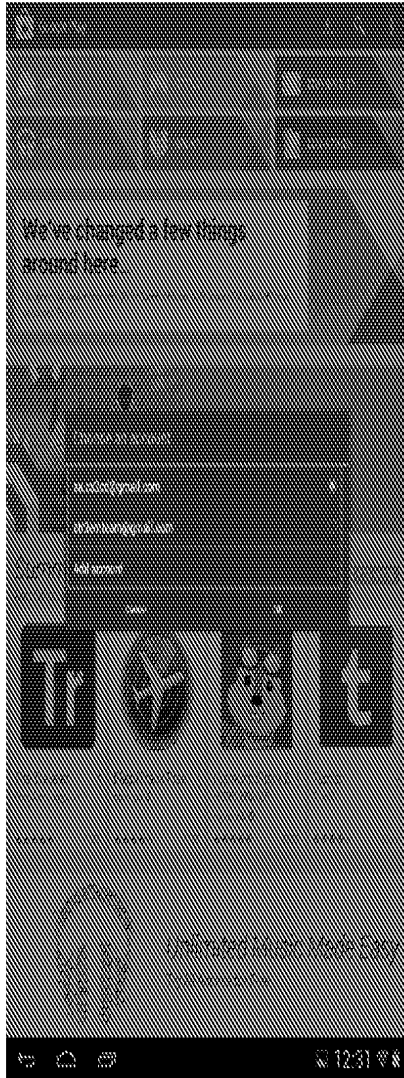

Source: Motorola Xoom screenshot

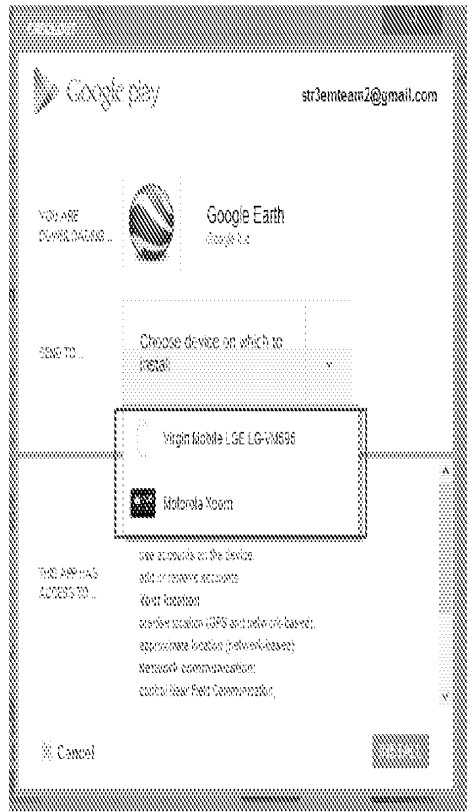

<https://play.google.com>

Claim 4	Technological Example
<p>The method according to claim 3, wherein the verification token represents verification from a provider of the token to grant access rights to the first user.</p>	<p><b>Add an account to use Google Play on your device</b></p> <p><i>To use Google Play on your Android device, you need a Google Account associated with your device. Additionally, the account must be associated with a Google email address (either Gmail or a Google-hosted domain). Follow these steps to add an existing Google Account to your device or create a new Google Account to add to your device.</i></p> <p>Source: <a href="https://support.google.com/googleplay/answer/2521798?hl=en">https://support.google.com/googleplay/answer/2521798?hl=en</a></p>

Claim 5	Technological Example
<p>The method according to claim 3, wherein the digital content is shared among one or more users according to a membership status.</p>	<p><b>Add an account to use Google Play on your device</b></p> <p><i>To use Google Play on your Android device, you need a Google Account associated with your device. Additionally, the account must be associated with a Google email address (either Gmail or a Google-hosted domain). Follow these steps to add an existing Google Account to your device or create a new Google Account to add to your device.</i></p> <p>Source: <a href="https://support.google.com/googleplay/answer/2521798?hl=en">https://support.google.com/googleplay/answer/2521798?hl=en</a></p>

Claim 6	Technological Example
<p>The method according to claim 5, wherein the one or more users are a network of recognized human beings using machines or recognized automated computerized mechanisms programmed by human beings, the recognition of the one or more users being validated by the membership status of the membership web service.</p>	<p><b>Add an account to use Google Play on your device</b></p> <p><i>To use Google Play on your Android device, you need a Google Account associated with your device. Additionally, the account must be associated with a Google email address (either Gmail or a Google-hosted domain). Follow these steps to add an existing Google Account to your device or create a new Google Account to add to your device.</i></p> <p>Source: <a href="https://support.google.com/googleplay/answer/2521798?hl=en">https://support.google.com/googleplay/answer/2521798?hl=en</a></p>

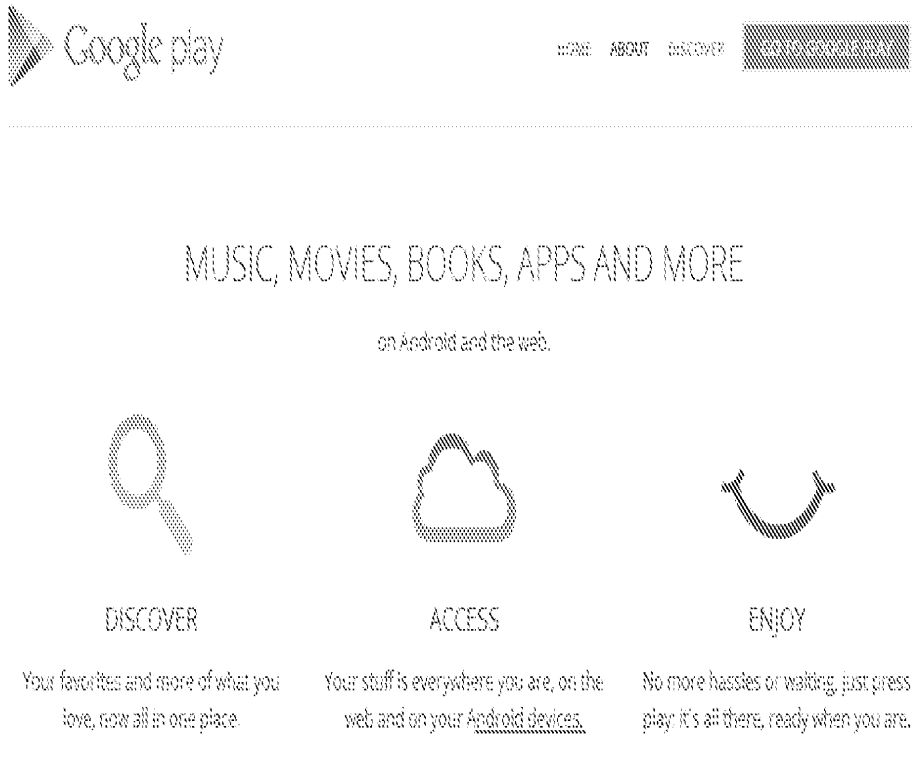
Claim 7	Technological Example
<p>The method according to claim 6, wherein the digital content access request is from a user using at least one of a computer or a phone hosting an operating system running an application.</p>	 <p>The screenshot shows the Google Play website interface. At the top left is the Google Play logo. To its right are navigation links: HOME, ABOUT, and DISCOVER. Below these is a horizontal dotted line. The main heading reads "MUSIC, MOVIES, BOOKS, APPS AND MORE" followed by "on Android and the web." Below this are three columns, each with an icon and a heading: a magnifying glass icon for "DISCOVER", a cloud icon for "ACCESS", and a play button icon for "ENJOY". Each heading is followed by a short descriptive sentence.</p> <p>Source: <a href="https://play.google.com/intl/en-US_us/about/overview/index.html">https://play.google.com/intl/en-US_us/about/overview/index.html</a></p>

# U.S. Patent 8,533,860: Apple iCloud

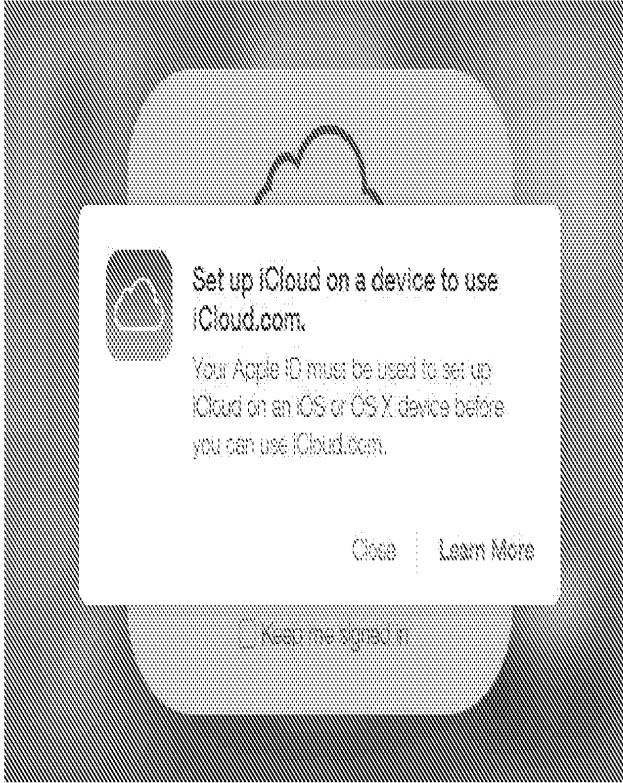
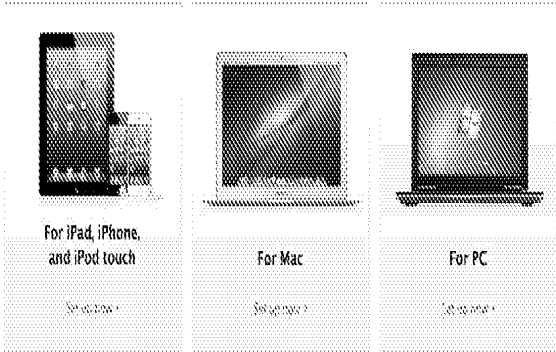
Claim 1	Technological Example
<p>A method for authorizing access to digital content using a cloud system, the cloud system comprising connected modules in operation as one or more of a cloud computing or a cloud storage in connection with devices and users, wherein the digital content is at least one of encrypted or not encrypted, the method facilitating access rights between a plurality of data processing devices, the method comprising:</p>	 <p>Source: <a href="http://www.ZLFORXGFRP">http://www.ZLFORXGFRP</a></p> <p><b>Set up iCloud on all your devices. The rest is automatic.</b></p> <p>To get the most out of iCloud, make sure to set it up on your iPad, iPhone, iPod touch, Mac, and PC.</p>  <p>For iPad, iPhone, and iPod touch      For Mac      For PC</p> <p>Set up now &gt;      Set up now &gt;      Set up now &gt;</p> <p>Source: <a href="http://www.apple.com/icloud/setup/">http://www.apple.com/icloud/setup/</a></p>



**Claim 1**

**Technological Example**

**Data Security**

iCloud secures your data by encrypting it when it is sent over the internet, storing it in an encrypted format when kept on server (review the table below for detail), and using secure tokens for authentication. This means that your data is protected from unauthorized access both while it is being transmitted to your devices and when it is stored in the cloud. iCloud uses a minimum of 128-bit AES encryption - the same level of security employed by major financial institutions - and never provides encryption keys to any third parties.

**Security and iCloud Features**

The table below summarizes how your data is secured when using various iCloud features:

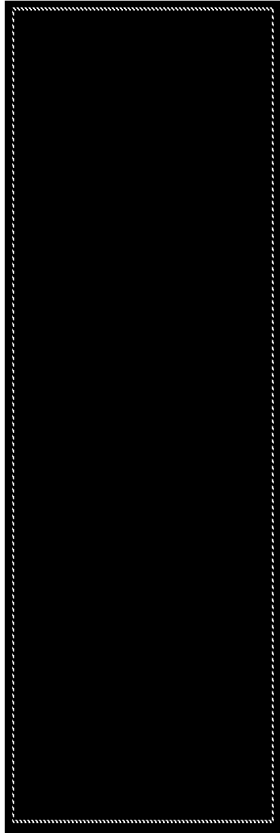

Notes	
	<u>A minimum of 128-bit AES encryption</u>
Web sessions of iCloud.com are encrypted with SSL. Any data accessed via iCloud.com is encrypted on server as indicated in this table.	
Back to My Mac does not store data on iCloud. Data retrieved from other computers is encrypted with SSL while in transit.	
Purchased or matched music files are not encrypted on server because they do not contain any personal information.	
IM traffic between your devices and iCloud Mail and Notes is encrypted with SSL. Consistent with standard industry practice, iCloud does not encrypt data stored on IMAP mail servers. All Apple email clients support optional SSL/TLS encryption.	

Source: <http://support.apple.com/kb/ht4865>

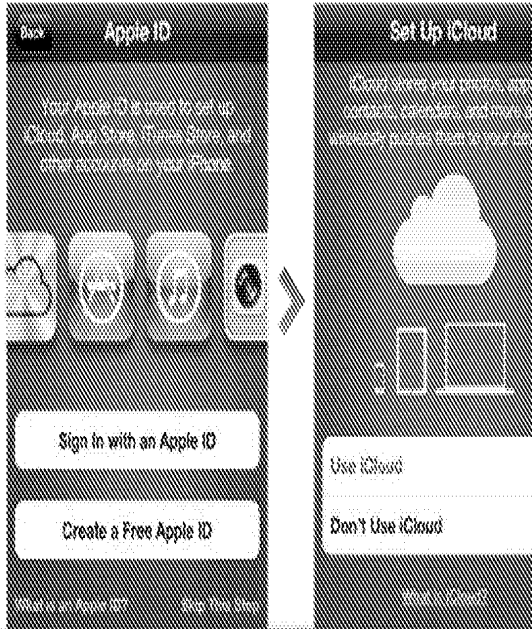
Claim 1	Technological Example
<p>receiving a digital content access request from at least one communications console of the plurality of data processing devices, the access request being a read or write request of metadata of the digital content, wherein the read or write request of metadata is performed in connection with a combination of at least one device and the cloud system, the request comprising a verification token provided by a first user corresponding to the digital content, wherein the verification token is one or more of a password, e-mail address, payment system, credit card, authorize ready device, rights token, or one or more redeemable instruments of trade;</p>	<div data-bbox="344 241 381 325" style="font-size: 2em; font-weight: bold; margin-bottom: 10px;">2</div> <div data-bbox="344 346 479 378" style="font-weight: bold;">Turn on iCloud.</div> <div data-bbox="344 394 649 567"> <p>When you turn on a new iOS device or after you've completed the update to the latest version of iOS, follow the instructions in the setup assistant to activate your device and set up iCloud.<sup>2</sup></p> </div> <div data-bbox="344 604 633 709"> <p>If you skipped the setup process, tap the Settings icon on the Home screen, select <u>iCloud</u>, then enter your Apple ID.</p> </div> <div data-bbox="344 741 649 808"> <p>Want to use a different Apple ID for iTunes? <a href="#">Learn more &gt;</a></p> </div> <div data-bbox="727 247 1263 871" style="text-align: center;">  </div> <div data-bbox="332 888 803 924"> <p>Source: <a href="http://www.apple.com/icloud/setup/ios.html">http://www.apple.com/icloud/setup/ios.html</a></p> </div> <div data-bbox="344 976 763 1024" style="font-weight: bold; margin-top: 20px;">Set up iCloud on your devices</div> <div data-bbox="344 1060 1136 1186"> <p>Before you can use iCloud, you need to create an iCloud account (<u>using your existing Apple ID if you have one already, or by creating a new one if you don't</u>), then turn on the iCloud features you want to use on each of your iOS devices and computers.</p> </div> <div data-bbox="344 1234 1153 1360"> <p>If you already installed iOS 5 or later on any of your <u>devices</u>, you were asked if you wanted to turn on iCloud. To make sure everything is set up correctly, or to set up your iCloud account on another device, go to the set up iCloud website listed below.</p> </div> <div data-bbox="344 1407 1063 1444"> <p><b>Important:</b> <u>Be sure to use the same iCloud account information on each device you set up.</u></p> </div> <div data-bbox="332 1491 795 1528"> <p>Source: <a href="http://help.apple.com/icloud/#mmfc0f1e2a">http://help.apple.com/icloud/#mmfc0f1e2a</a></p> </div>

**Claim 1**

**Technological Example**

wherein the verification token is one or more of a password, e-mail address, payment system, credit card, authorize ready device, rights token, or one or more redeemable instruments of trade;

An Apple ID is the email address you use as a login for just about everything you do with Apple, including using iCloud to store your content, buying songs from the iTunes Store, and downloading apps from the App Store.

When you set up your iPhone, iPad, or iPod touch, you can use the same Apple ID for iCloud services and purchases on the iTunes Store, App Store, and iBookstore. You can also use one Apple ID for iCloud services and another Apple ID for store purchases (including iTunes in the Cloud and iTunes Match). You will get all the benefits of iCloud whether you use the same Apple ID for iCloud and store purchases, or different IDs for each.

Source: <http://support.apple.com/kb/HT4895>

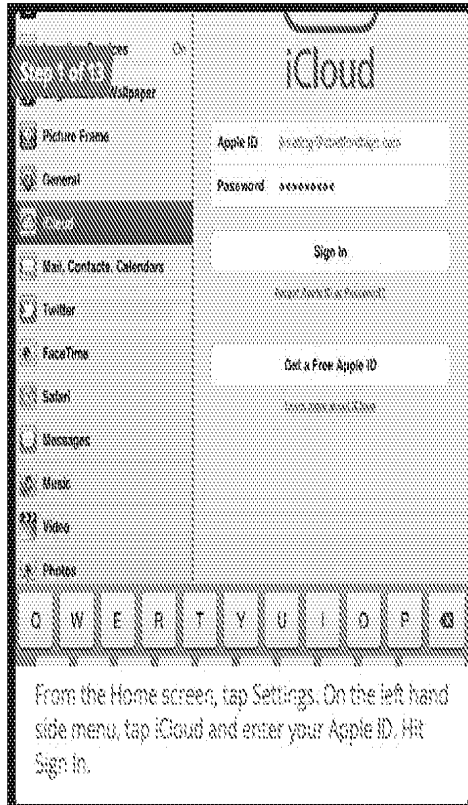

Source: <http://snapguide.com/guides/setup-icloud-back-up-use-locate-my-iphone/>

**Claim 1**

**Technological Example**

authenticating the verification token;

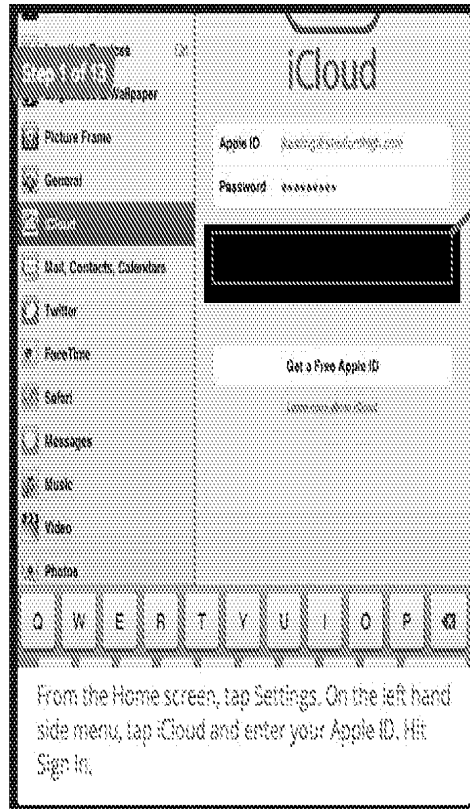

From the Home screen, tap Settings. On the left hand side menu, tap iCloud and enter your Apple ID. Hit Sign in.

Source: <http://snapguide.com/guides/setup-icloud-back-up-use-locate-my-iphone/>

Source: <http://www.lovefone.co.uk/blog/setting-up-an-icloud-account-more/>

### Claim 1

### Technological Example

establishing a connection with the at least one communications console, wherein the communications console is a combination of a graphic user interface (GUI) and an Application Programmable Interface (API) wherein the API is a verified web service, the web service capable of facilitating a two way data exchange session to complete a verification process wherein the data exchange session comprises at least one identification reference;



#### Customize your settings.

Tap the Settings icon and select iCloud. Tap the On/Off switches to enable individual iCloud services. To enable iCloud Backup, tap Storage & Backup and turn on iCloud Backup.

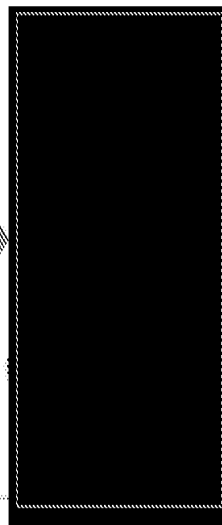
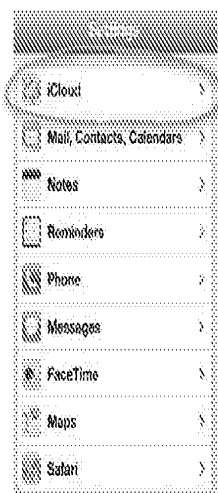

Source: <http://www.apple.com/icloud/setup/ios.html>

## Using iCloud Storage APIs with Your iOS and Mac Apps

iCloud Storage APIs enable your apps to store content in iCloud, keeping your apps up to date automatically. Use iCloud to give your users a consistent and seamless experience across iCloud-enabled devices.

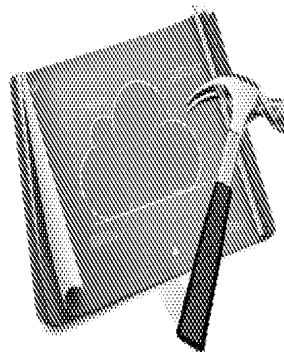

Source:

<https://developer.apple.com/icloud/index.php>

The `NSUUID` class creates UUID strings that are to uniquely identify types, interfaces, and other items.

UUIDs (Universally Unique Identifiers), also known as GUIDs (Globally Unique Identifiers) or IIDs (Interface Identifiers), are 128-bit values. A UUID is made unique over both space and time by combining a value unique to the computer on which it was generated and a value representing the number of 100-nanosecond intervals since October 15, 1582 at 00:00:00.

Source: [http://developer.apple.com/library/ios/#documentation/Foundation/Reference/NSUUID\\_Class/Reference/Reference.html#//apple\\_ref/occ/clm/NSUUID/UUID](http://developer.apple.com/library/ios/#documentation/Foundation/Reference/NSUUID_Class/Reference/Reference.html#//apple_ref/occ/clm/NSUUID/UUID)

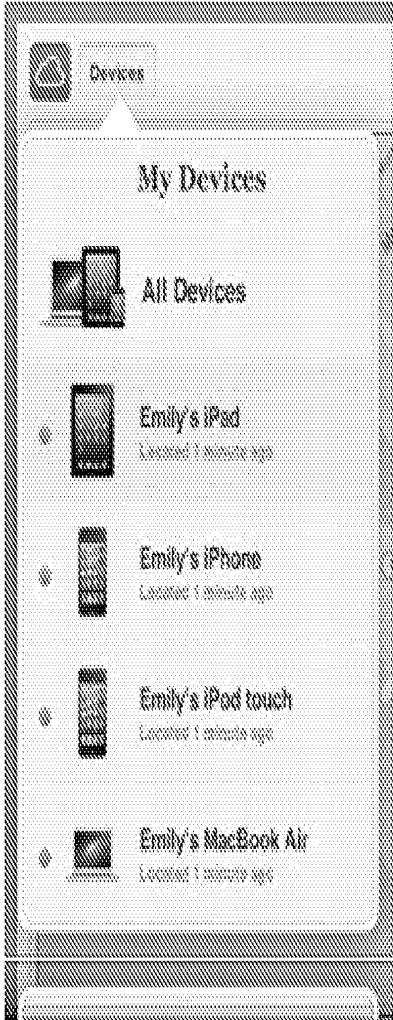
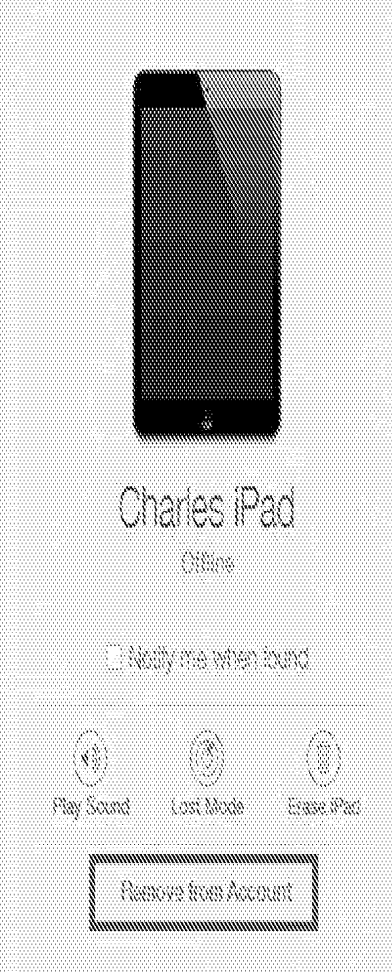
Claim 1	Technological Example
<p>requesting at least one identification reference from the at least one communications console, wherein the identification reference comprises one or more of a verified web service account identifier, letter, number, rights token, email, password, access time, serial number, address, manufacturer identification, checksum, operating system version, browser version, credential, cookie, or key;</p> <p>receiving the at least one identification reference from the at least one communications console;</p> <p>and</p>	<p>The <code>NSUUID</code> class creates UUID strings that are to uniquely identify types, interfaces, and other items.</p> <p>UUIDs (Universally Unique Identifiers), also known as GUIDs (Globally Unique Identifiers) or IIDs (Interface Identifiers), are 128-bit values. A UUID is made unique over both space and time by combining a value unique to the computer on which it was generated and a value representing the number of 100-nanosecond intervals since October 15, 1582 at 00:00:00.</p> <p>Source: <a href="http://developer.apple.com/library/ios/#documentation/Foundation/Reference/NSUUID_Class/Reference/Reference.html#/apple_ref/occ/clm/NSUUID/UUID">http://developer.apple.com/library/ios/#documentation/Foundation/Reference/NSUUID_Class/Reference/Reference.html#/apple_ref/occ/clm/NSUUID/UUID</a></p> <div style="display: flex; justify-content: space-around;"> <div data-bbox="337 661 727 1675">  </div> <div data-bbox="808 661 1198 1627">  </div> </div> <p>Source: <a href="http://support.apple.com/kb/PH2698?viewlocale=en_US">http://support.apple.com/kb/PH2698?viewlocale=en_US</a></p>

**Claim 1**

**Technological Example**

writing at least one of the verification token or the identification reference into the metadata.

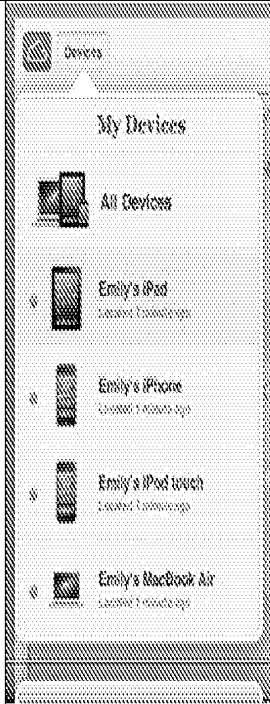

Source: [http://support.apple.com/kb/PH2698?viewlocale=en\\_US](http://support.apple.com/kb/PH2698?viewlocale=en_US)



Your contacts on all your devices.

Source: <http://www.apple.com/icloud/>

**Claim 2**

**Technological Example**

The method according to claim 1, wherein the access request being a request from the first user through a data processing device of the plurality of data processing devices; or wherein the access request being a request from one or more secondary users in network to the first user; wherein the secondary users are validated by a membership web service.

iCloud puts your content on all your devices.

Everywhere. Automatically. That's the way it should be, and iCloud makes it a reality. So when you buy a song, you don't have to download it over and over to enjoy it on multiple devices. Or worry that a document doesn't contain your latest revisions. Or spend time transferring photos. iCloud takes care of everything for you, just like that.

[Learn more >](#)



Source: <http://www.apple.com/icloud/>



**Claim 3**

**Technological Example**

The method according to claim 2, wherein the metadata comprises one or more of a software or contents of a web page.



Source: [http://support.apple.com/kb/PH2698?viewlocale=en\\_US](http://support.apple.com/kb/PH2698?viewlocale=en_US)

Source: <http://help.apple.com/icloud/#mm8e44092d>

### Claim 4

### Technological Example

The method according to claim 3, wherein the verification token represents verification from a provider of the token to grant access rights to the first user.

An Apple ID is the email address you use as a login for just about everything you do with Apple, including using iCloud to store your content, buying songs from the iTunes Store, and downloading apps from the App Store.

When you set up your iPhone, iPad, or iPod touch, you can use the same Apple ID for iCloud services and purchases on the iTunes Store, App Store, and iBookstore. You can also use one Apple ID for iCloud services and another Apple ID for store purchases (including iTunes in the Cloud and iTunes Match). You will get all the benefits of iCloud whether you use the same Apple ID for iCloud and store purchases, or different IDs for each.

Source: <http://support.apple.com/kb/HT4895>

## 2

### Turn on iCloud.

When you turn on a new iOS device or after you've completed the update to the latest version of iOS, follow the instructions in the setup assistant to activate your device and set up iCloud.<sup>1</sup>

If you skipped the setup process, tap the Settings icon on the Home screen, select iCloud, then enter your Apple ID.

Want to use a different Apple ID for iTunes?  
[Learn more >](#)



Source: <http://www.apple.com/icloud/setup/ios.html>

**Claim 5**

**Technological Example**

The method according to claim 3, wherein the digital content is shared among one or more users according to a membership status.



Source: [http://support.apple.com/kb/PH2698?viewlocale=en\\_US](http://support.apple.com/kb/PH2698?viewlocale=en_US)

Source: <http://help.apple.com/icloud/#mm8e44092d>

**Claim 6**

**Technological Example**

The method according to claim 5, wherein the one or more users are a network of recognized human beings using machines or recognized automated computerized mechanisms programmed by human beings, the recognition of the one or more users being validated by the membership status of the membership web service.



Source: [http://support.apple.com/kb/PH2698?viewlocale=en\\_US](http://support.apple.com/kb/PH2698?viewlocale=en_US)

Source: <http://help.apple.com/icloud/#mm8e44092d>

**Claim 7**

**Technological Example**

The method according to claim 6, wherein the digital content access request is from a user using at least one of a computer or a phone hosting an operating system running an application.

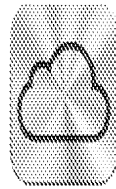

**iCloud**

iCloud does more than store your content: -- it lets you access your music, photos, calendars, contacts, documents, and more, from whatever device you're on. And it's built into every new iOS device and every new Mac. [Learn more >](#)

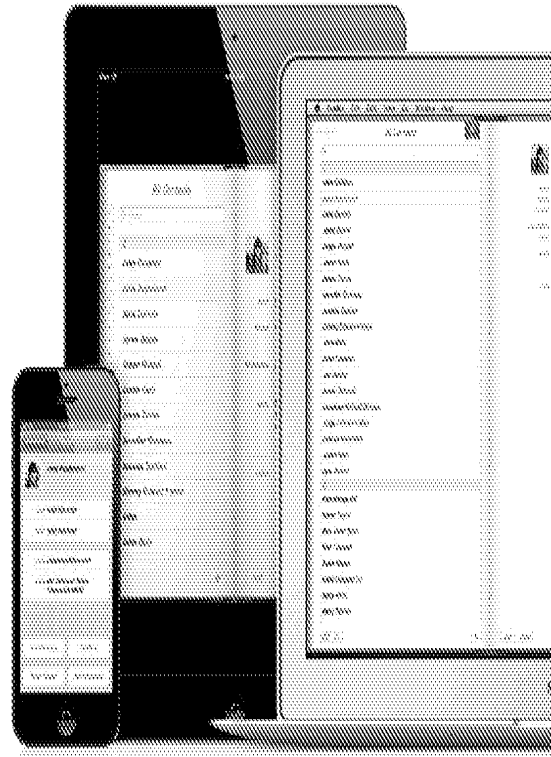

Your contacts on all your devices.

Source: <http://www.apple.com/icloud/>

**Claim 8**

**Technological Example**

The method of claim 7, wherein the verification token comprises at least one token selected from the group consisting of a purchase permission, a rental permission, or a membership permission; wherein the at least one of purchase permission, rental permission, or membership permission is represented by one or more of a letter, number, combination of letters and numbers, rights token, successful payment reference, phrase, name, membership credentials, image, logo, tag, service name, authorization, list, interface button, downloadable program, or an instrument of trade.

That required a team of biometric experts and hardware engineers to rethink how sensor technology works and redesign the iconic Home button. Made from laser-cut sapphire crystal, the surface of the button directs the image of your finger to a capacitive touch sensor, which reads beneath the outer layers of your skin to get a detailed print. Surrounding the button is a stainless steel ring that detects your finger, wakes the sensor, and improves the signal-to-noise ratio. Software then reads the ridges of your print and finds the match to unlock your phone. It's all highly advanced technology that simply disappears as you use it. So you don't notice anything. Except now unlocking your iPhone is suddenly so effortless.

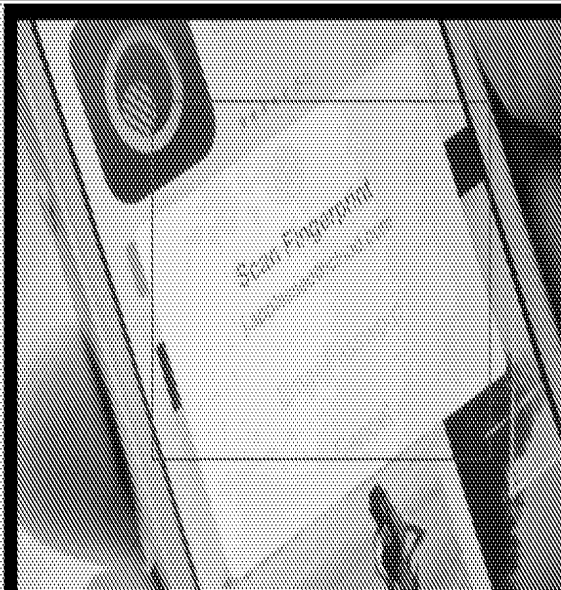
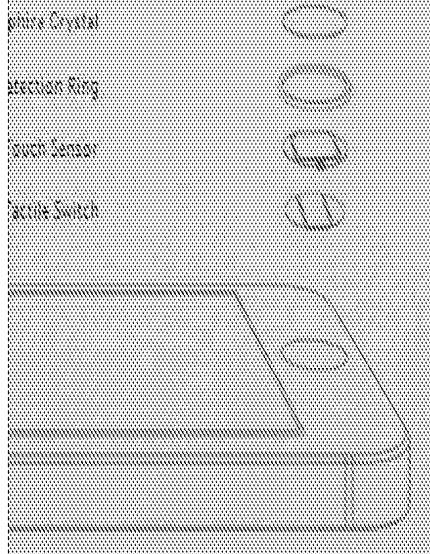

Source: <http://www.apple.com/iphone-5s/design/>

Source top: <http://www.apple.com/iphone-5s/videos/#video-touch>

Source bottom: <http://www.apple.com/iphone-5s/features/>

# U.S. Patent 8,533,860: Sony Entertainment Network

Claim 1	Technological Example
<p>A method for authorizing access to digital content using a cloud system, the cloud system comprising connected modules in operation as one or more of a cloud computing or a cloud storage in connection with devices and users, wherein the digital content is at least one of encrypted or not encrypted, the method facilitating access rights between a plurality of data processing devices, the method comprising:</p>	<p>Source: <a href="http://www.sonyentertainmentnetwork.com/home/">http://www.sonyentertainmentnetwork.com/home/</a></p>

Claim 1	Technological Example
	<p>Your compliance with all of the following are express conditions of Your license to use or access the Property. You may not sell, rent, lease, loan, sublicense, modify, adapt, arrange, translate, reverse engineer, decompile, or disassemble any portion of the Property. Except as stated in this Agreement or as SNEI expressly permits by SNEI, you may not reproduce or transfer any portion of the Property. You may not create any derivative works, attempt to create the source code from the object code, or download or use any Property for any purpose other than as expressly permitted. You may not bypass, disable, or circumvent any <u>encryption, security, digital rights management or authentication mechanism</u> in connection with SEN First Party Services, Authorized Devices, or any of the content or services offered through SEN First Party Services. You may use the Property only on Authorized Devices. You acknowledge that SEN First Party Services and content or services provided through SEN First Party Services may contain security or technical features that will prevent use of such content or services in violation of this Agreement. Property is not licensed to you for resale, public performance, display, distribution or broadcast. Except as this Agreement expressly grants, SNEI and its licensors reserve all rights, interests, and remedies in connection with SEN First Party Services and the Property. Upon termination of this Agreement, Your Account, or license to any Property, You will immediately cease use of the Property and delete or destroy copies of the Property.</p> <p>Source: <a href="http://www.sonyentertainmentnetwork.com/terms-of-service/">http://www.sonyentertainmentnetwork.com/terms-of-service/</a></p>



**Claim 1**

**Technological Example**

receiving a digital content access request from at least one communications console of the plurality of data processing devices, the access request being a read or write request of metadata of the digital content, wherein the read or write request of metadata is performed in connection with a combination of at least one device and the cloud system, the request comprising a verification token provided by a first user corresponding to the digital content, wherein the verification token is one or more of a password, e-mail address, payment system, credit card, authorize ready device, rights token, or one or more redeemable instruments of trade;

The screenshot shows the PlayStation Network website with a navigation bar at the top containing links for Home, PS4, PS3, PS3™, PS Vita, PS®6, and PS2. The main content area is titled "If you have forgotten or want to change your SEN account password". Below the title, there is a paragraph explaining that users can reset their password via their PS3, PS Vita, or PSP system, or by using a PC. An "IMPORTANT:" section follows, with two bullet points: "We will email you a link to reset your password. If you have forgotten your password and you do not have access to the email address you use as your Sign-In ID (Email Address) do not attempt to reset your password. Instead, contact us for further assistance." and "We will also ask for the date of birth you entered when you created your account. If you do not know the date of birth used do not attempt to reset your password. Instead, contact us for further assistance." Below this, a section titled "Please click on the device you are using for instructions on how to retrieve or change your password" features four icons: PC, PS3, PS Vita, and PSP. Further down, there are three links: "I don't have access to the email address associated with my account - what should I do?", "If you do not have access to the email address associated with your account, or are unable to successfully set a new password using the methods provided, please click here to find out if you can change your Sign-In ID (Email Address).", and "If you can't change your Sign-In ID (Email Address) please Contact Us for further assistance." The final link is "I have not received a password reset email - what should I do?". On the right side of the page, there are sections for "PlayStation Support Survey", "Quick Links" (Return to FAQs, Ask a Question, Print Article, Email Article), and "Related Articles" (Contact us, If you have forgotten or want to change your SEN sign-in ID (email address), Change Sub Account Password, Define ID, Common solutions for troubleshooting the PLAYSTATION 3).

Source: [http://faq.en.playstation.com/app/answers/detail/a\\_id/5602](http://faq.en.playstation.com/app/answers/detail/a_id/5602)

Claim 1

Technological Example

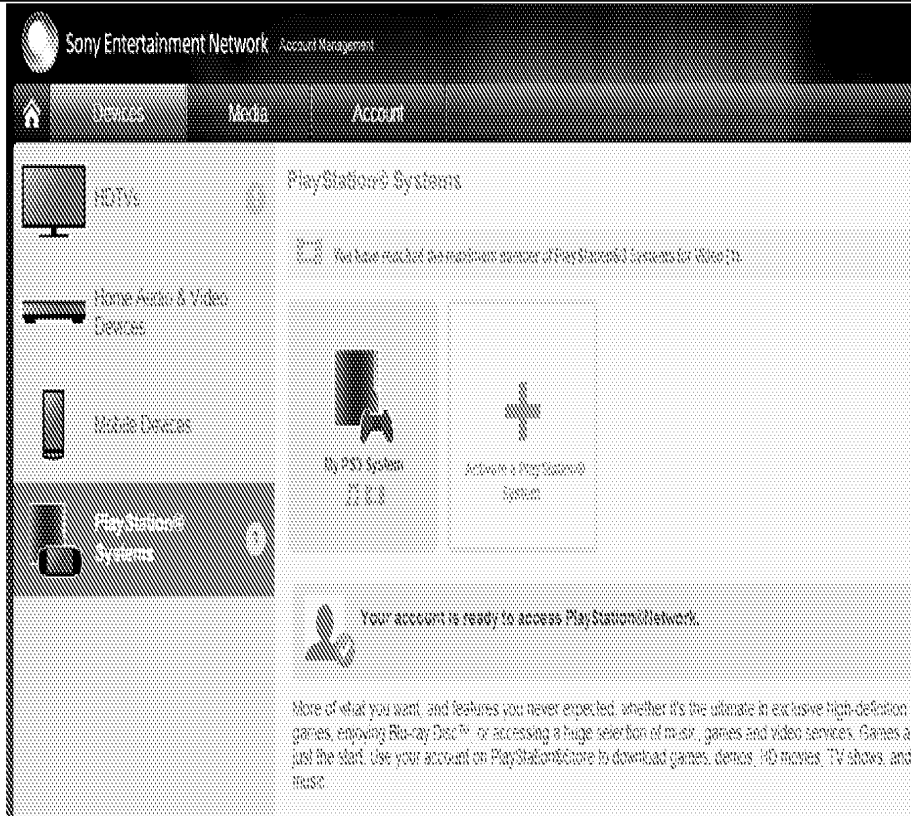

Source: <https://account.sonyentertainmentnetwork.com/liquid/cam/devices/device-list.action?category=psn&displayNavigation=false>

authenticating the verification token;

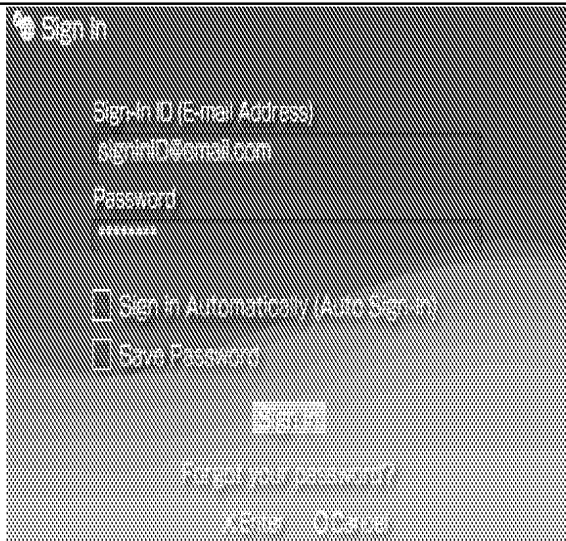

Source: PlayStation 3

Claim 1

Technological Example

**Video Unlimited: Link my HDTV**

How do I activate (link) an HDTV to my account? Related Products & Categories

Once your HDTV is activated on your Sony Entertainment Network account you can access SEN or 3rd party services (subject to membership and service terms and conditions) directly through your HDTV.

You can link either up to 4 or up to 15 SEN accounts to your BRAVIA® depending on the model. You will be able to tell which link is available from the 'Link Account' screen as the number of spaces for accounts will correspond with the limit.

First of all, please check that your TV is SEN enabled by checking the features of your device on Sony.com and set up a Sony Entertainment Network account via [sonyentertainmentnetwork.com](http://sonyentertainmentnetwork.com).

To link your HDTV to your account simply follow these steps:

1. Connect your HDTV to the internet.
2. Select the SEN icon on the far left of the XMB™ Menu (this is the device 'home' menu). If this icon does not appear, please check the Service Status on [sonyentertainmentnetwork.com](http://sonyentertainmentnetwork.com) as maintenance may be restricting your network access and check that your device firmware is up to date - you can find latest firmware information on Sony.com.
3. If your BRAVIA® model includes the option to 'Add Account' select this option and follow the on screen prompts to link your account. You can now use network services!
4. On a computer or mobile device connected to the internet sign-in to your Sony Entertainment Network account. Go to the 'Devices' tab and select HDTVs from the left of the screen and click on '+ Activate a Device'.
5. Enter the activation code from your TV into the space provided.
6. Follow the instructions and choose your device PIN.
7. You can now use network services!

If you see a message on your device asking you to update your Sony Essentials account, this means that your device has been registered through the previous 'Essentials' system. If you are unable to migrate your account to a Sony Entertainment Network account from the Sony Essentials website, please contact us for assistance.

If your activation code is not working for another reason please contact us for help.

Source:

[http://us.support.sonyentertainmentnetwork.com/app/answers/detail/a\\_id/695/session/L3RpbWUvMTM4MjMlNjgzOC9zaWQvT11BcW9sRGw/%3D](http://us.support.sonyentertainmentnetwork.com/app/answers/detail/a_id/695/session/L3RpbWUvMTM4MjMlNjgzOC9zaWQvT11BcW9sRGw/%3D)

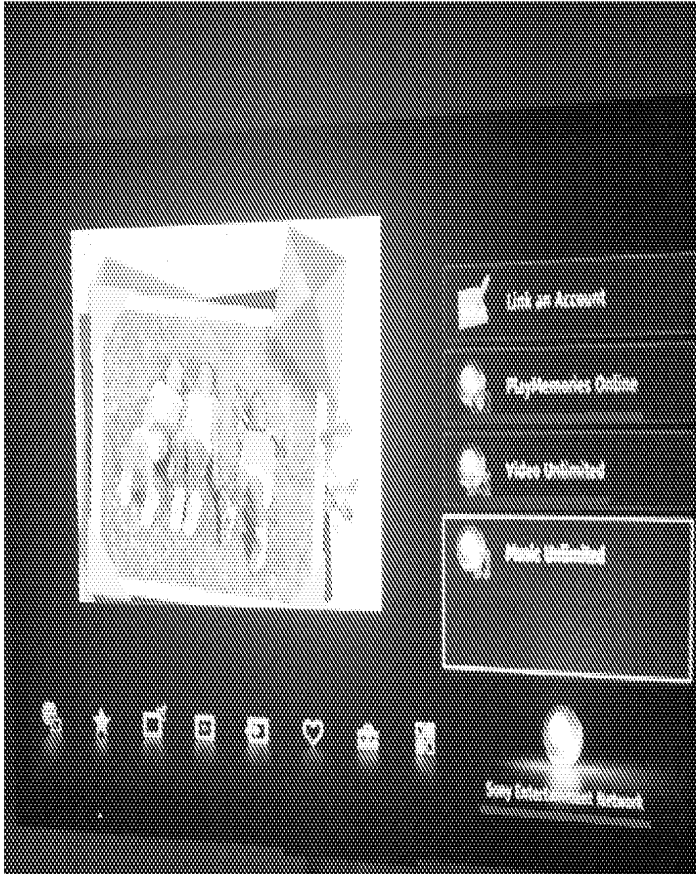
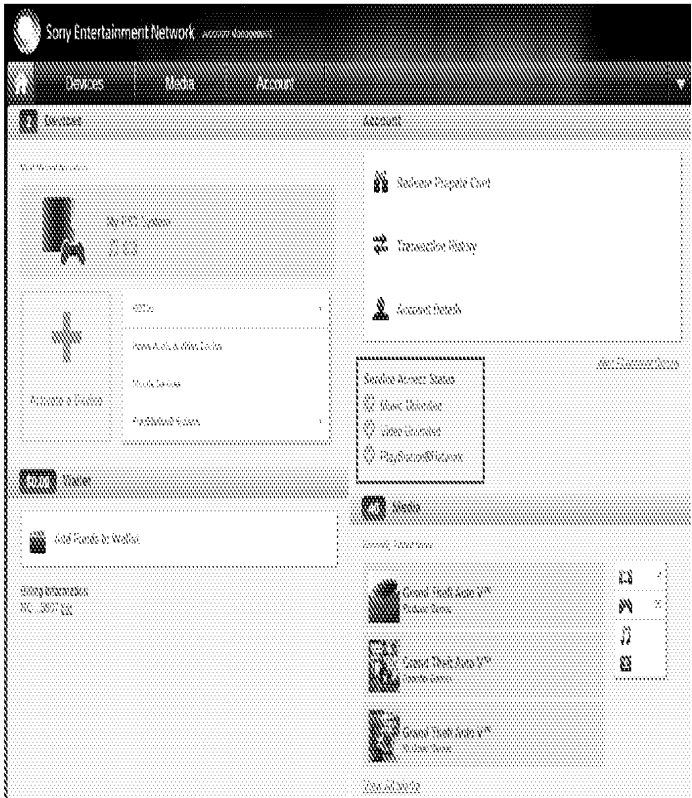
Claim 1	Technological Example
<p>establishing a connection with the at least one communications console, wherein the communications console is a combination of a graphic user interface (GUI) and an Application Programmable Interface (API) wherein the API is related to a verified web service, the web service capable of facilitating a two way data exchange session to complete a verification process wherein the data exchange session comprises at least one identification reference;</p>	 <p>Source: Sony Bravia HDTV</p>  <p>Source: SEN Account Manager</p>

Software Engineer in Test - SNEI - SF Job Listing at Sony Electronics in San Francisco, CA  
 (Job ID: sonyelectronics26876)

**Sony Electronics**  
 Location: San Francisco, CA  
 Posted: 10/10/2013  
 Refreshed: 10/21/2013  
 Application deadline: None  
 Type: Not specified  
 Career Level: Not specified  
 Salary Range: Not specified  
 Number of Jobs: 1  
 Relocation Available: No  
[Show all jobs for Sony Electronics](#)

Push the button to see who you know here.

Send this job:

Industries

Electronics, Entertainment

Description

Title: Software Engineer in Test - SNEI - SF

Location: CA-San Francisco

Job Number: 26876

Do you have

experience with Java API white box testing?

Or you have

experience with REST API testing?

Do you have

experience designing and implementing test or secure API testing frameworks?

Sony Network

Entertainment International LLC (EIN), a subsidiary of Sony Corporation of America, is the premier provider of digital entertainment. Through the Sony Entertainment Network portal, consumers around the world are able to access their favorite digital entertainment simultaneously and instantly on their favorite content hub such as DVD, offer the latest and highest quality music, video, and game content through Sony Entertainment Network as well as PlayStation Network while also delivering third party services. In addition, EIN provides a compelling consumer experience through innovative content discovery features and a simple user interface that is globally consistent, yet locally relevant.

Software Engineer in

Test

San Francisco, CA

Job Summary:

The Software Engineer in Test will be part of newly formed Entertainment Cloud Software group responsible for delivering cloud content software for Sony devices. This person is responsible for building end-to-end test cases from ground zero to execute various aspects of software services. You will have the opportunity to work with very passionate engineers and also get a chance to work with cutting edge cloud based technologies.



Get alerts for jobs like this:

Software Engineer in Test - SNEI - SF

Electronics

San Francisco, CA



Email



Mobile



Twitter

Get jobs like this tweeted to you:

Software Dev. - Generalist Jobs in San Francisco, CA

[Follow](#)

View similar jobs:

Program Manager - IT

Open-Source - San Francisco, CA

Database Admin - Cloud/Platform Project

Web Page - San Francisco, CA

Unit Support Engineer - S

Web Page - San Francisco, CA

Locate this job:

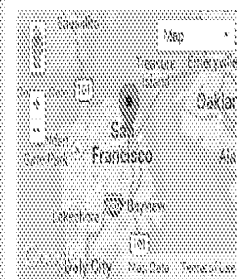

Source: <http://www.tweetyjobs.com/sony-electronics-jobs-software-engineer-in-test-snei-sf-11599429>

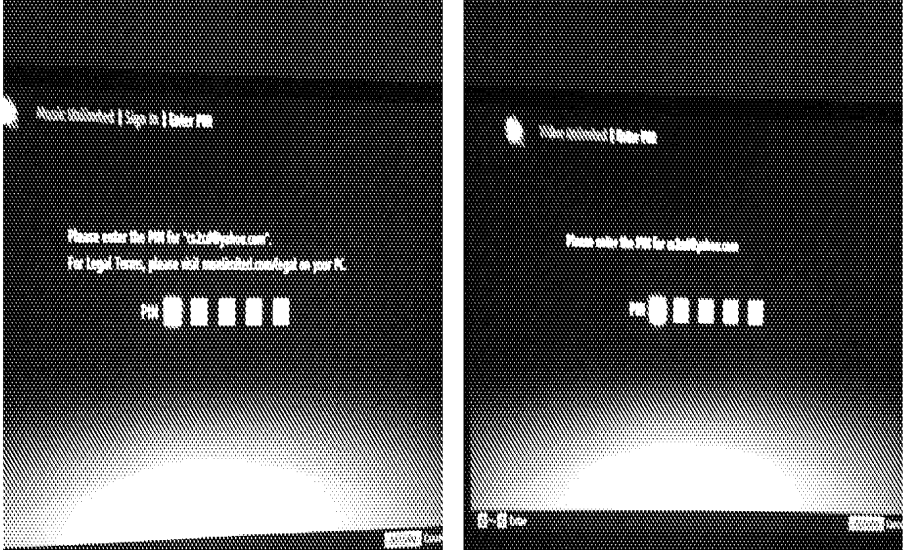
Claim 1	Technological Example
<p>requesting the at least one identification reference from the at least one communications console, wherein the identification reference comprises one or more of a verified web service account identifier, letter, number, rights token, e-mail, password, access time, serial number, address, manufacturer identification, checksum, operating system version, browser version, credential, cookie, or key;</p> <p>receiving the at least one identification reference from the at least one communications console;</p> <p>and</p>	 <p>Source: PS3</p>  <p>Source: Sony Bravia HDTV</p>

**Claim 1**

**Technological Example**

writing at least one of the verification token or the identification reference into the metadata.

Watch Movies Everywhere

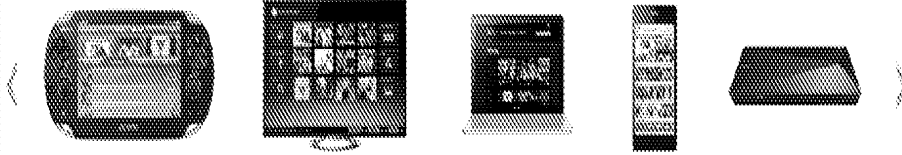

Watch Movies On:

- Bravia® Televisions
- Blu-ray Disc™ Players
- Blu-ray Home Theater Systems
- PlayStation®3 Systems\*
- PC Via™
- PSP®
- Sony Internet TV powered by Google TV
- Sony Netfix
- Sony Tablets
- Windows-based PCs through Media Go
- Xperia™ Mobile Phones

Source: <http://www.sonyentertainmentnetwork.com/video-unlimited/watch-movies/>

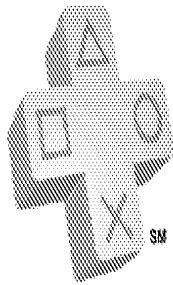

**PlayStation®Plus**

**PlayStation®Plus**

Introducing the new PlayStation®Plus, the membership service designed to bring games and gamers together, and fuel the next generation of gaming on the PS4™ system. PlayStation®Plus helps you discover a world of extraordinary gaming experiences through the ever-expanding collection of great games that members receive access to as part of their membership. With PlayStation®Plus on the PS4™ system, you'll also discover a world of like-minded gamers to play with and challenge, connected through an all-new multiplayer service worthy of the next generation.

Source: <http://us.playstation.com/ps4/index.htm>

Claim 1

Technological Example

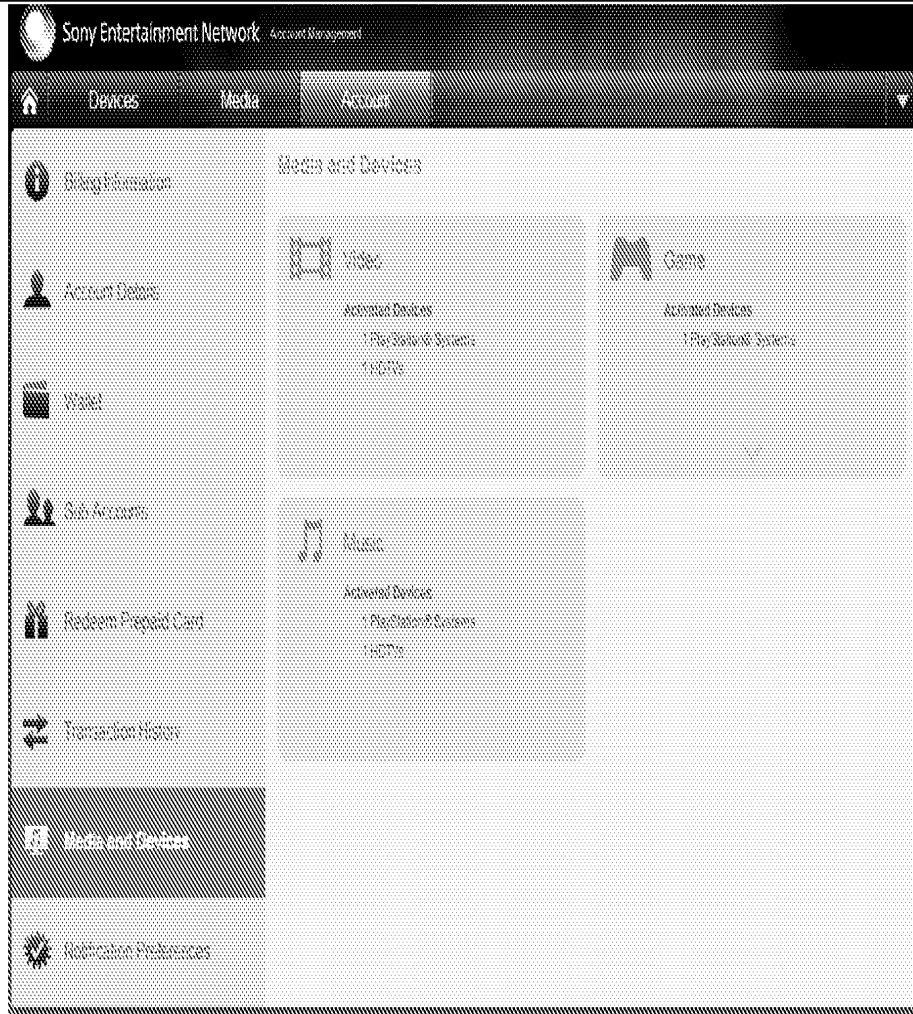

Source: <https://account.sonyentertainmentnetwork.com/liquid/cam/devices/device-media-list.action?displayNavigation=false>



**Claim 2**

**Technological Example**

The method according to claim 1, wherein the access request being a request from the first user through a data processing device of the plurality of data processing devices; or wherein the access request being a request from one or more secondary users in network to the first user; wherein said secondary users are validated by a membership web service.

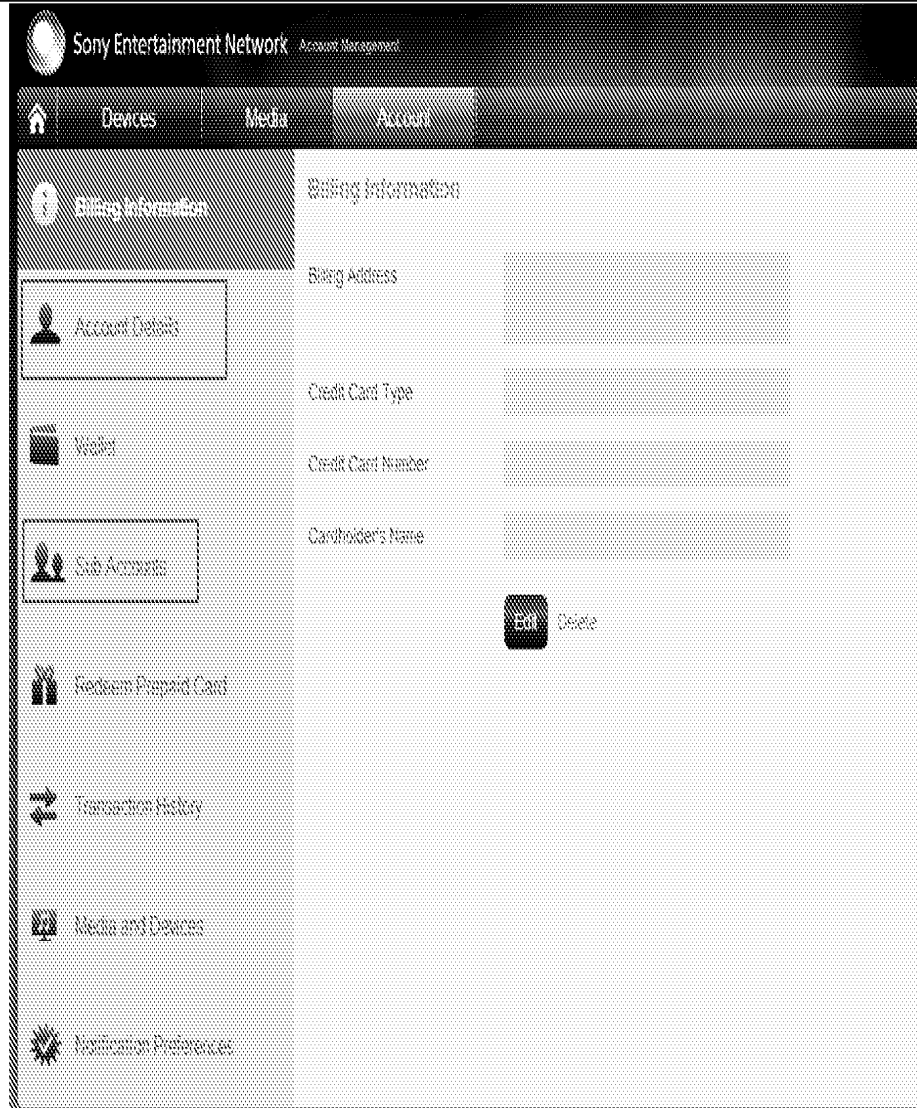

Source: SEN Account Manager

**Claim 3**

**Technological Example**

The method according to claim 2, wherein the metadata comprises one or more of a software or contents of a web page.

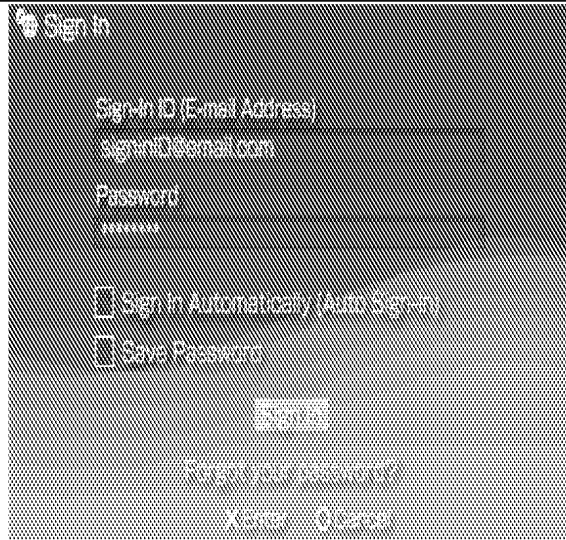

Source: PlayStation 3 hardware device

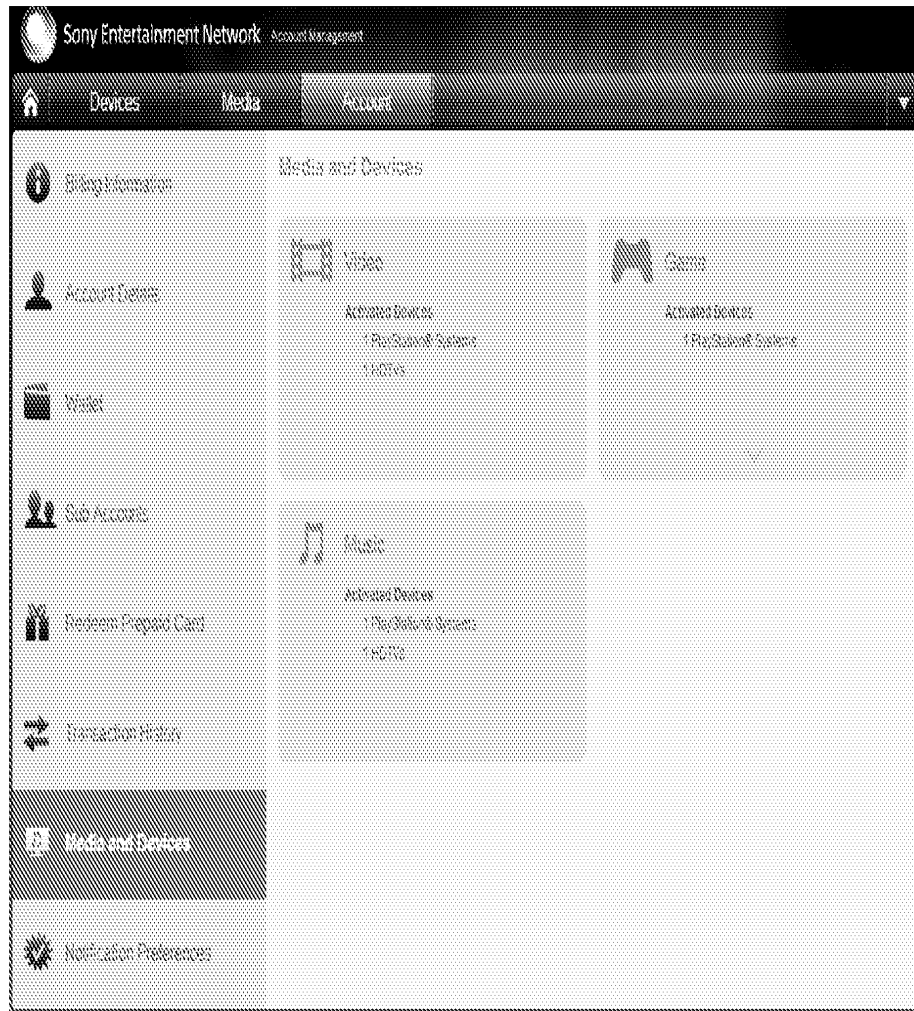

Source: SEN web based Account Management

Claim 4	Technological Example
<p>The method according to claim 3, wherein the verification token represents verification from a provider of the token to grant access rights to the first user.</p>	 <p>Source: <a href="http://www.sonyentertainmentnetwork.com/home/">http://www.sonyentertainmentnetwork.com/home/</a></p>

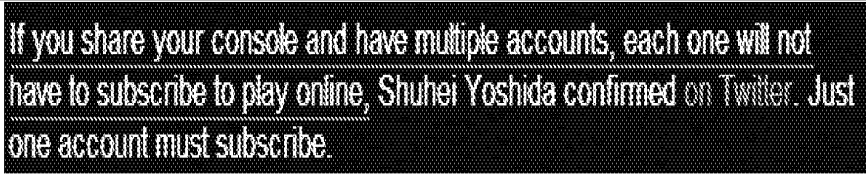
Claim 5	Technological Example
<p>The method according to claim 3, wherein the digital content is shared among one or more users according to a membership status.</p>	 <p>Source: <a href="http://www.playstationlifestyle.net/2013/06/11/one-playstation-plus-account-on-ps4-will-allow-other-accounts-to-play-online-on-same-console/">http://www.playstationlifestyle.net/2013/06/11/one-playstation-plus-account-on-ps4-will-allow-other-accounts-to-play-online-on-same-console/</a></p>

## Electronic Acknowledgement Receipt

<b>EFS ID:</b>	19178269
<b>Application Number:</b>	13740086
<b>International Application Number:</b>	
<b>Confirmation Number:</b>	7081
<b>Title of Invention:</b>	PERSONALIZED DIGITAL MEDIA ACCESS SYSTEM - PDMAS PART II
<b>First Named Inventor/Applicant Name:</b>	William Grecia
<b>Customer Number:</b>	70984
<b>Filer:</b>	William Grecia
<b>Filer Authorized By:</b>	
<b>Attorney Docket Number:</b>	
<b>Receipt Date:</b>	31-MAY-2014
<b>Filing Date:</b>	11-JAN-2013
<b>Time Stamp:</b>	11:30:18
<b>Application Type:</b>	Utility under 35 USC 111(a)

### Payment information:

Submitted with Payment	no
------------------------	----

### File Listing:

Document Number	Document Description	File Name	File Size(Bytes)/ Message Digest	Multi Part /.zip	Pages (if appl.)
1	Miscellaneous Incoming Letter	merged_document.pdf	6043287 <small>5b52e1d6f8218aef5358f2e32e49e94da105da97</small>	no	40

### Warnings:

EWS-003618

The page size in the PDF is too large. The pages should be 8.5 x 11 or A4. If this PDF is submitted, the pages will be resized upon entry into the Image File Wrapper and may affect subsequent processing

**Information:**

**Total Files Size (in bytes):**

6043287

**This Acknowledgement Receipt evidences receipt on the noted date by the USPTO of the indicated documents, characterized by the applicant, and including page counts, where applicable. It serves as evidence of receipt similar to a Post Card, as described in MPEP 503.**

**New Applications Under 35 U.S.C. 111**

**If a new application is being filed and the application includes the necessary components for a filing date (see 37 CFR 1.53(b)-(d) and MPEP 506), a Filing Receipt (37 CFR 1.54) will be issued in due course and the date shown on this Acknowledgement Receipt will establish the filing date of the application.**

**National Stage of an International Application under 35 U.S.C. 371**

**If a timely submission to enter the national stage of an international application is compliant with the conditions of 35 U.S.C. 371 and other applicable requirements a Form PCT/DO/EO/903 indicating acceptance of the application as a national stage submission under 35 U.S.C. 371 will be issued in addition to the Filing Receipt, in due course.**

**New International Application Filed with the USPTO as a Receiving Office**

**If a new international application is being filed and the international application includes the necessary components for an international filing date (see PCT Article 11 and MPEP 1810), a Notification of the International Application Number and of the International Filing Date (Form PCT/RO/105) will be issued in due course, subject to prescriptions concerning national security, and the date shown on this Acknowledgement Receipt will establish the international filing date of the application.**

## **This is a technological patent.**

The technological scope of the claims are demonstrated, but not limited to, technological examples expressed and attached herein.

Relevant USPTO advanced patent and patent application search formula:

aclm/api and aclm/cloud and aclm/rights  
aclm/api and aclm/cloud and aclm/right

*Date: May 20, 2010*

Vic Gundotra, the Google SVP of Engineering

Source: <http://youtu.be/IY3U2GXhz44?t=31m10s>

Statements: "I want to go a little bit beyond Froyo and show you a **sneak peek**" - 31:25 "**Unlike anything you've ever seen before.**"

*Date: June 6, 2011*

Steve Jobs, CEO Apple

Source: <http://youtu.be/gfj7UgCMsqs?t=1h20m19s>

Statements: We've got a great solution for this problem, and we think this solution is **our next big insight**.

Apple's iCloud patent application wherein the examiner recognizes this patent disclosure as prior art in a 102(e) rejection: 12/766,337

*Date: August 31, 2011*

Kaz Hirai, Sony executive and Sony UK Blog

Source: <http://uk.playstation.com/introducingsonyentertainmentnetwork/>



Statements: Sony announces the Sony Entertainment Network (SEN) - "**a new platform** - Sony Entertainment Network" and "services will be **realigned** under Sony Entertainment Network"

Sony's SEN patent application wherein the examiner recognizes this patent disclosure as the closest prior art: 13/312,184 – *Applicant submits that the examiner of 13/312,184 provides an inaccurate analysis of this patent disclosure as the word "transmit" or any variation thereof is not found within the specification of this patent.*

**This document is submitted to support a default defense against frivolous CBM and reexamination request as a strategic tool by defendants to force a "stay" in possible associated court matters.**

**Technological examples continue on page 2 of this document.**

# U.S. Patent 8,533,860: Google Play

<p><b>Claim 1</b></p>	<p><b>Technological Example</b></p>
<p>A method for authorizing access to digital content using a cloud system, the cloud system comprising connected modules in operation as one or more of a cloud computing or a cloud storage in connection with devices and users, wherein the digital content is at least one of encrypted or not encrypted, the method facilitating access rights between a plurality of data processing devices, the method comprising:</p>	 <p>Google play</p> <p>HOME ABOUT DISCOVER CONTACT US</p> <p>DISCOVER</p> <p>MUSIC, MOVIES, BOOKS, APPS AND MORE</p> <p>on Android and the web.</p> <p>ACCESS</p> <p>ENJOY</p> <p>Your favorites and more of what you love, now all in one place.</p> <p>Your stuff is everywhere you are, on the web and on your Android devices.</p> <p>No more hassles or waiting, just press play. It's all there, ready when you are.</p> <p>Source: <a href="https://play.google.com/intl/en-US_us/about/overview/index.html">https://play.google.com/intl/en-US_us/about/overview/index.html</a></p> <p>Play anytime, anywhere</p> <p>Google Play comes with the convenience of the cloud, so your music, movies, books, magazines and TV shows are always available for the web and on your Android devices.</p> <p>You can buy a movie on your phone and stream it on your computer, and then pause it and then watching it on your tablet later on. Your entertainment is available across your devices so you can read, listen, watch and play on any device anytime, anywhere.</p> <p>No internet access? No problem, you can make your content available offline too.</p> <p>Get started</p> 

Claim 1

Technological Example

Support article:

663. In accordance with Google Play on your device.

Use a Google Apps account.

"You haven't accessed the Google Play Store app on your device with this email account." Transfer music files via USB.

"You haven't accessed the Google Play Store app on your device with this email account."

You will receive the error "You haven't accessed the Google Play Store app (the white shopping bag app icon) on your device with this email account. Learn More," on the Google Play website if:

\* Your phone or tablet isn't a supported device. There is no way to manually add your phone or tablet to the device list on play.google.com, and you will not be able to use the Google Play website.

\* You are trying to use the Google Play website before using the Google Play Store app on your device. It may take several minutes after using the Google Play Store app on your device for that phone or tablet to show up on play.google.com. If you don't have the Google Play Store app installed on your device, contact your carrier or manufacturer for further assistance.

Source: <https://support.google.com/googleplay/answer/1141080>

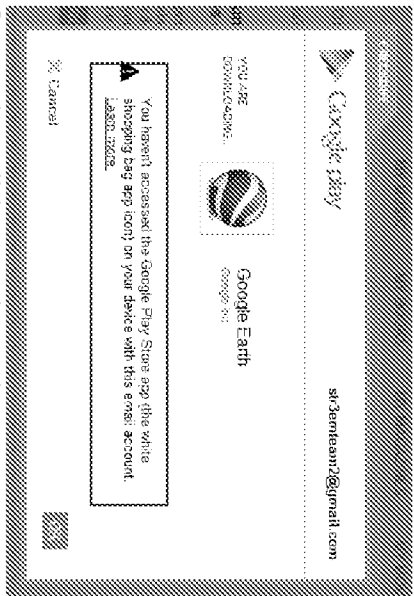

Source: <https://play.google.com/apps>

Manage your devices

You can stream music in your library to any device or computer via a browser on which you're signed in. You can also download music in your library to any authorized device or computer. You can authorize up to a total of ten devices or computers at any one time. At this time, only two Google accounts per computer can be used to add music with the Google Play Music Manager.

Music from your library cannot be played simultaneously on more than one device. If you're currently playing music, you'll need to stop playback in order to play your music on another device.

Source: <https://support.google.com/googleplay/answer/1230356?hl=en>



**Claim 1**

receiving a digital content access request from at least one communications console of the plurality of data processing devices, the access request being a read or write request of metadata of the digital content, wherein the read or write request of metadata is performed in connection with a combination of at least one device and the cloud system, the request comprising a verification token provided by a first user corresponding to the digital content, wherein the verification token is one or more of a password, e-mail address, payment system, credit card, authorize ready device, rights token, or one or more redeemable instruments of trade;

**Technological Example**

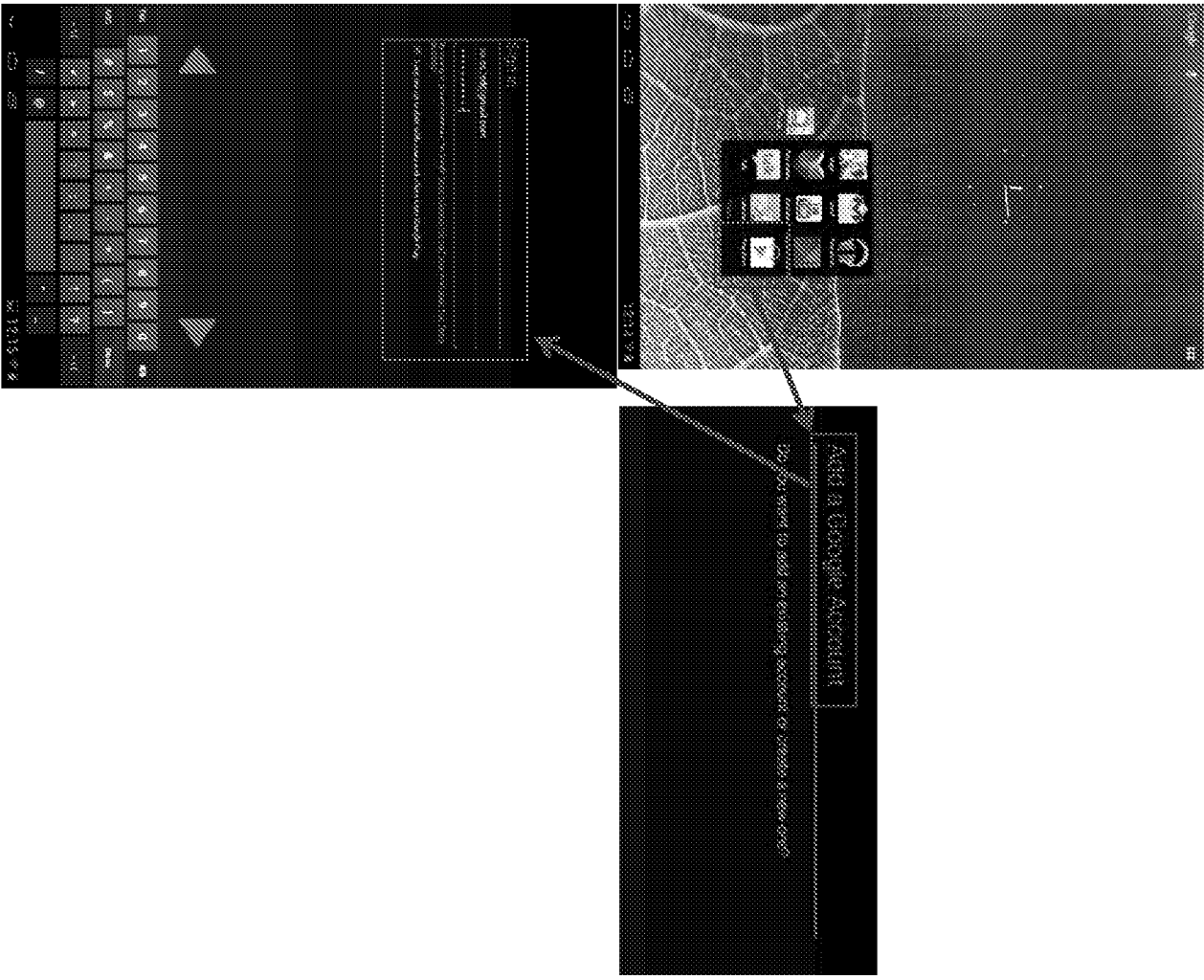

Source: Motorola XOOM Tablet

**Claim 1**

authenticating the verification token;

**Technological Example**

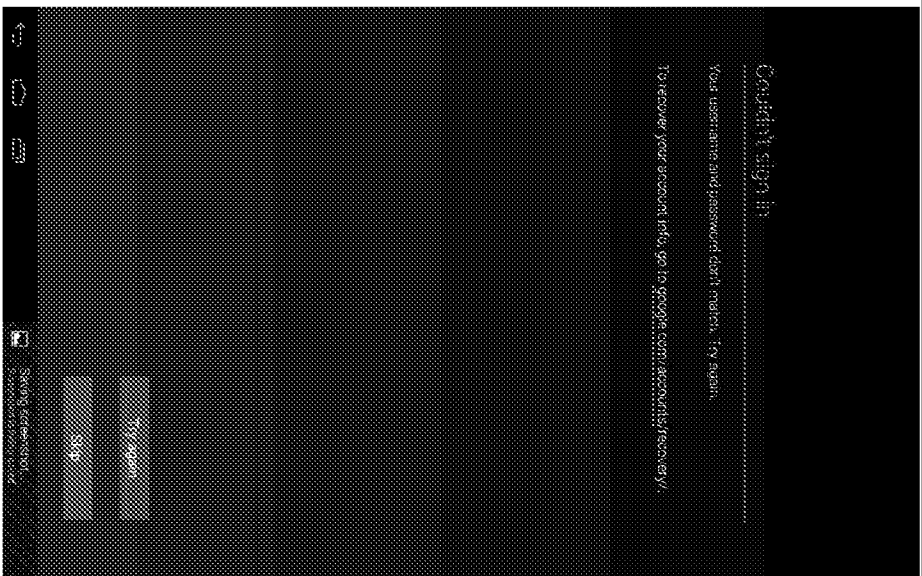
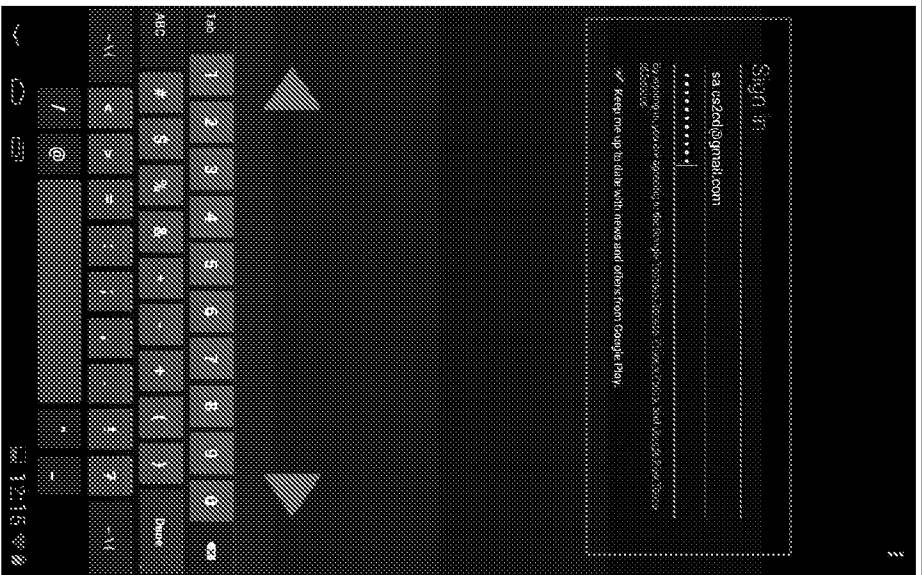

Source: Motorola XOOM Tablet

**Username & password errors**

The most common cause of username/password mismatch errors when trying to access Google Play is that your account uses 2-step verification, but you haven't set up an application-specific password for use on your Android phone or tablet.

Source: <https://support.google.com/googleplay/answer/2651409?hl=en>

**Claim 1**

establishing a connection with the at least one communications console, wherein the communications console is a combination of a graphic user interface (GUI) and an Application Programmable Interface (API) wherein the API is related to a verified web service, the web service capable of facilitating a two way data exchange session to complete a verification process wherein the data exchange session comprises at least one identification reference;

**Technological Example**

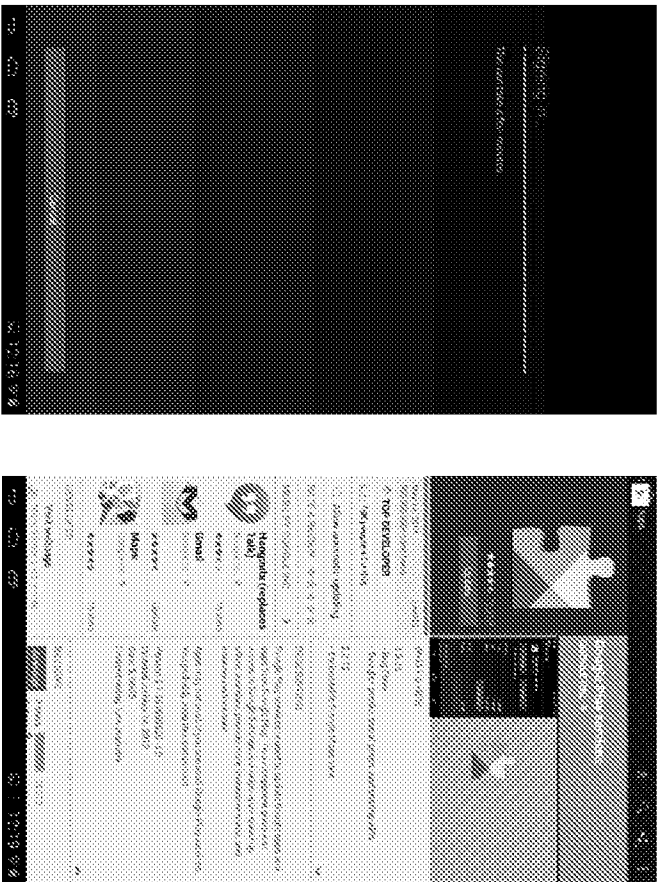

**The Google Play services APK**

The Google Play services APK contains the individual Google services and runs as a background service in the Android OS. You interact with the background service through the client library and the service carries out the actions on your behalf. An easy-to-use authorization flow is also provided to gain access to the each Google service, which provides consistency for both you and your users.

The Google Play services APK is delivered through the Google Play Store, so updates to the services are not dependent on carrier or OEM system image updates. In general, devices running Android 2.2 (Froyo) or later and have the Google Play Store app installed, receive updates within a few days. This allows you to use the newest APIs in Google Play services and reach most of the devices in the Android ecosystem (devices older than Android 2.2 or devices without the Google Play Store app are not supported).

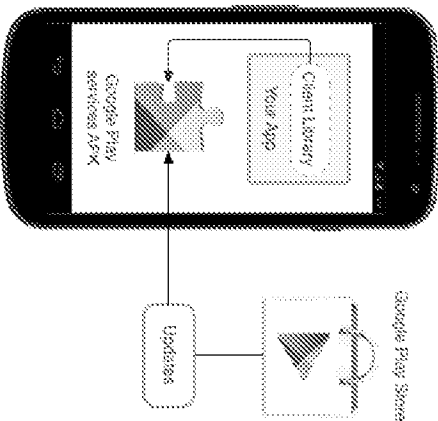

Source: <http://developer.android.com/google/play-services/index.html>



**Claim 1**

writing at least one of the verification token or the identification reference into the metadata.

**Technological Example**

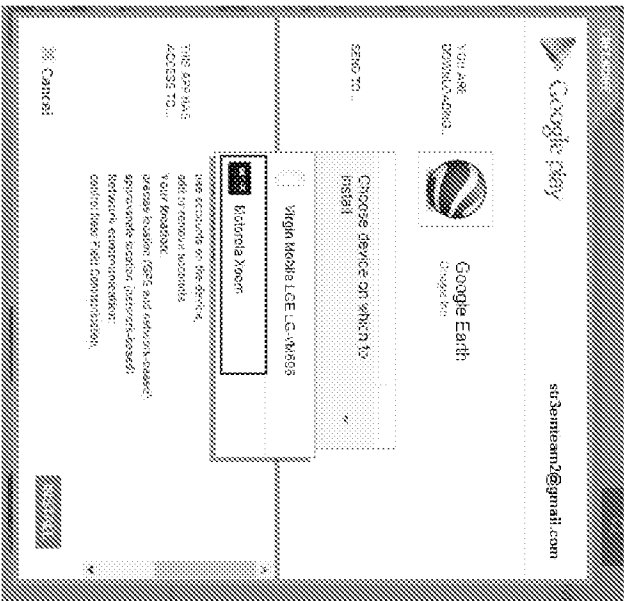

**Claim 2**

The method according to claim 1, wherein the access request being a request from the first user through a data processing device of the plurality of data processing devices; or wherein the access request being a request from one or more secondary users in network to the first user; wherein said secondary users are validated by a membership web service.

**Technological Example**

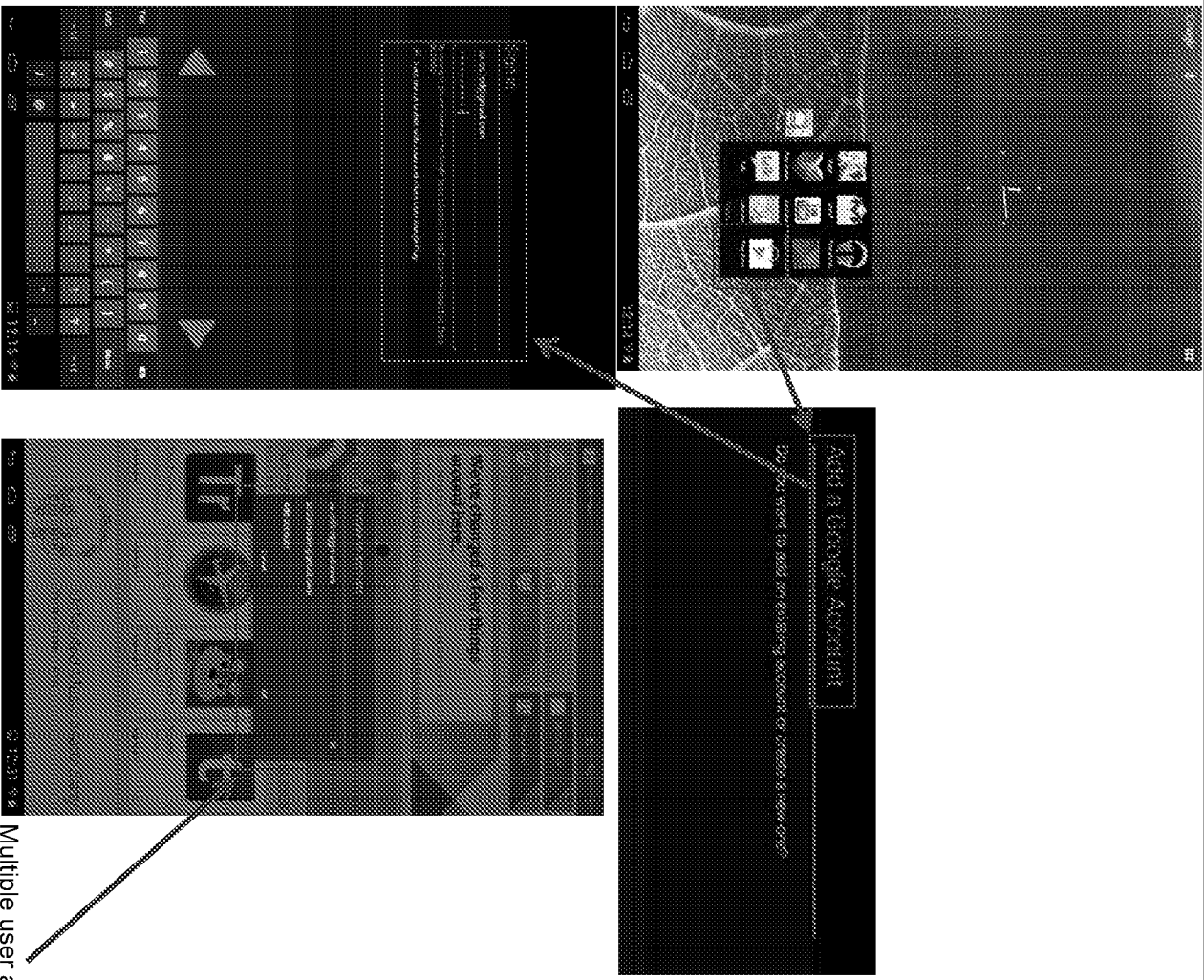

Source: Motorola XOOM Tablet

Multiple user account

**Claim 3**

The method according to claim 2, wherein the metadata comprises one or more of a software or contents of a web page.

**Technological Example**

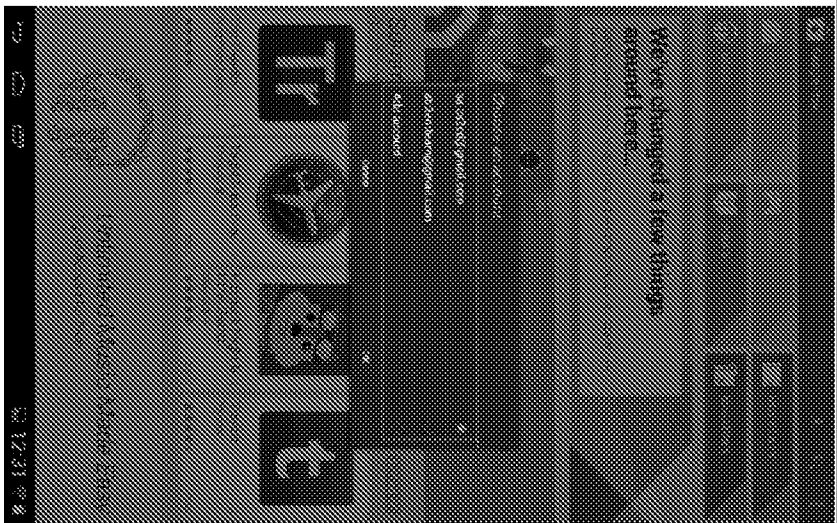

Source: Motorola Xoom screenshot

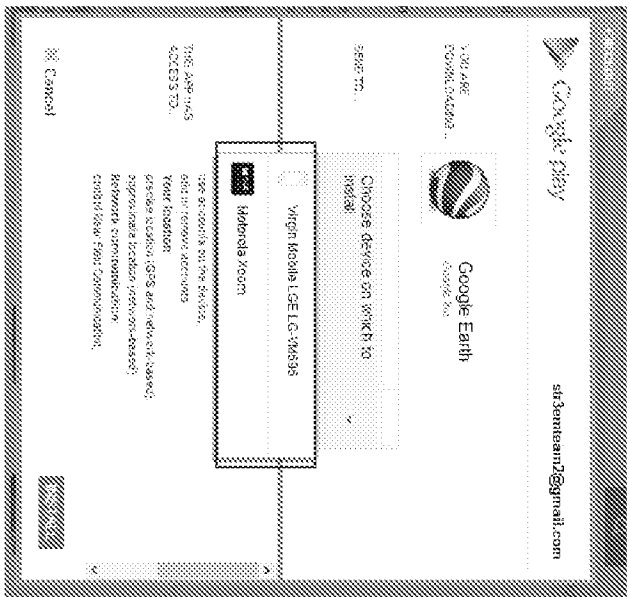

<https://play.google.com>

<p><b>Claim 4</b></p> <p>The method according to claim 3, wherein the verification token represents verification from a provider of the token to grant access rights to the first user.</p>	<p style="text-align: center;"><b>Technological Example</b></p> <p><b>Add an account to use Google Play on your device</b></p> <p><i>To use Google Play on your Android device, you need a Google Account associated with your device. Additionally, the account must be associated with a Google email address (either Gmail or a Google-hosted domain). Follow these steps to add an existing Google Account to your device or create a new Google Account to add to your device.</i></p> <p>Source: <a href="https://support.google.com/googleplay/answer/2521798?hl=en">https://support.google.com/googleplay/answer/2521798?hl=en</a></p>
---	--

<p><b>Claim 5</b></p> <p>The method according to claim 3, wherein the digital content is shared among one or more users according to a membership status.</p>	<p style="text-align: center;"><b>Technological Example</b></p> <p><b>Add an account to use Google Play on your device</b></p> <p><i>To use Google Play on your Android device, you need a Google Account associated with your device. Additionally, the account must be associated with a Google email address (either Gmail or a Google-hosted domain). Follow these steps to add an existing Google Account to your device or create a new Google Account to add to your device.</i></p> <p>Source: <a href="https://support.google.com/googleplay/answer/2521798?hl=en">https://support.google.com/googleplay/answer/2521798?hl=en</a></p>
---	--

<p><b>Claim 6</b></p> <p>The method according to claim 5, wherein the one or more users are a network of recognized human beings using machines or recognized automated computerized mechanisms programmed by human beings, the recognition of the one or more users being validated by the membership status of the membership web service.</p>	<p style="text-align: center;"><b>Technological Example</b></p> <p><b>Add an account to use Google Play on your device</b></p> <p><i>To use Google Play on your Android device, you need a Google Account associated with your device. Additionally, the account must be associated with a Google email address (either Gmail or a Google-hosted domain). Follow these steps to add an existing Google Account to your device or create a new Google Account to add to your device.</i></p> <p>Source: <a href="https://support.google.com/googleplay/answer/2521798?hl=en">https://support.google.com/googleplay/answer/2521798?hl=en</a></p>
--	--



**Claim 7**

The method according to claim 6, wherein the digital content access request is from a user using at least one of a computer or a phone hosting an operating system running an application.

**Technological Example**

The screenshot shows the Google Play store interface. At the top left is the Google Play logo. To the right are navigation links: HOME, ABOUT, and DISCOVER. Below these is a horizontal bar with the text "MUSIC, MOVIES, BOOKS, APPS AND MORE" and "on Android and the web." Below this are three main sections: "DISCOVER" with a magnifying glass icon, "ACCESS" with a cloud icon, and "ENJOY" with a play button icon. Each section has a short descriptive sentence. At the bottom, there is a source URL: "Source: [https://play.google.com/intl/en-US\\_us/about/overview/index.html](https://play.google.com/intl/en-US_us/about/overview/index.html)".

Google play

HOME ABOUT DISCOVER

MUSIC, MOVIES, BOOKS, APPS AND MORE

on Android and the web.

DISCOVER

ACCESS

ENJOY

Your favorites and more of what you love, now all in one place.

Your stuff is everywhere you are, on the web and on your Android devices.

No more hassles or waiting, just press play. It's all there, ready when you are.

Source: [https://play.google.com/intl/en-US\\_us/about/overview/index.html](https://play.google.com/intl/en-US_us/about/overview/index.html)

# U.S. Patent 8,533,860: Apple iCloud

## Technological Example

### Claim 1

A method for authorizing access to digital content using a cloud system, the cloud system comprising connected modules in operation as one or more of a cloud computing or a cloud storage in connection with devices and users, wherein the digital content is at least one of encrypted or not encrypted, the method facilitating access rights between a plurality of data processing devices, the method comprising:

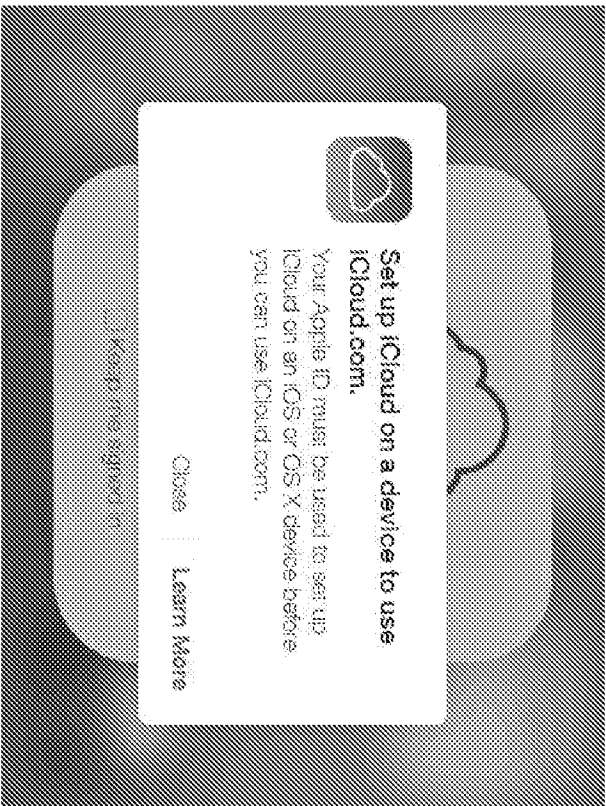

Source: <http://wwzlf0rxgfrp>

**Set up iCloud on all your devices.  
The rest is automatic.**

*To get the most out of iCloud, make sure to set it up on your iPad, iPhone, iPod touch, Mac, and PC.*

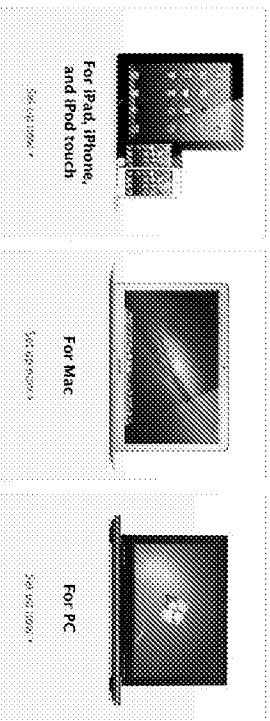

Source: <http://www.apple.com/icloud/setup/>

Claim 1

Technological Example

**Data Security**

iCloud secures your data by encrypting it when it is sent over the internet, storing it in an encrypted format when kept on server (review the table below for details) and using secure tokens for authentication. This means that your data is protected from unauthorized access both while it is being transmitted to your devices and when it is stored in the cloud. iCloud uses a minimum of 128-bit AES encryption - the same level of security employed by major financial institutions - and never provides encryption keys to any third parties.

**Security and iCloud Features**

The table below summarizes how your data is secured when using various iCloud features:

Notes
A minimum of 128-bit AES encryption
All sessions of iCloud mail are encrypted with SSL. Any data received via iCloud.com is encrypted on server as indicated in this table.
Data on iOS, Mac, other iOS store data on iCloud: Data received from iPhone synchronizes is encrypted with SSL while in transit.
Downloaded or watched music files are not encrypted on server (secure being do not transmit any personal information)
Mail (iCloud) between your devices and iCloud Mail and Server is encrypted with SSL. Consistent with standard industry practice, iCloud does not encrypt data stored on third party servers. All Apple mail clients support approved SMTP encryption

Source: <http://support.apple.com/kb/ht4865>

**Claim 1**

receiving a digital content access request from at least one communications console of the plurality of data processing devices, the access request being a read or write request of metadata of the digital content, wherein the read or write request of metadata is performed in connection with a combination of at least one device and the cloud system, the request comprising a verification token provided by a first user corresponding to the digital content, wherein the verification token is one or more of a password, e-mail address, payment system, credit card, authorize ready device, rights token, or one or more redeemable instruments of trade;

**Technological Example**

**2**  
**Turn on iCloud.**  
When you turn on a new iOS device or after you've completed the update to the latest version of iOS, follow the instructions in the setup assistant to activate your device and set up iCloud.  
If you skipped the setup process, tap the Settings icon on the Home screen, select iCloud, then enter your Apple ID.  
Want to use a different Apple ID for iTunes? Learn more.

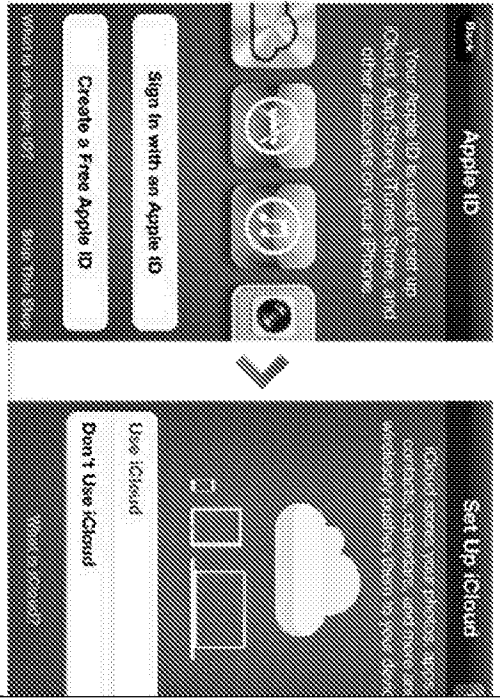

Source: <http://www.apple.com/icloud/setup/ios.html>

**Set up iCloud on your devices**

Before you can use iCloud, you need to create an iCloud account (using your existing Apple ID, if you have one already, or by creating a new one if you don't), then turn on the iCloud features you want to use on each of your iOS devices and computers.

If you already installed iOS 5 or later on any of your devices, you were asked if you wanted to turn on iCloud. To make sure everything is set up correctly, or to set up your iCloud account on another device, go to the set up iCloud website listed below.

**Important:** Be sure to use the same iCloud account information on each device you set up.

Source: <http://help.apple.com/icloud/#mmfc0f1e2a>

**Claim 1**

**Technological Example**

Wherein the verification token is one or more of a password, e-mail address, payment system, credit card, authorize ready device, rights token, or one or more redeemable instruments of trade;

An Apple ID is the email address you use as a login for just about everything you do with Apple, including using iCloud to store your content, buying songs from the iTunes Store, and downloading apps from the App Store. When you set up your iPhone, iPad, or iPod touch, you can use the same Apple ID for iCloud services and purchases on the iTunes Store, App Store, and iBookstore. You can also use one Apple ID for iCloud services and another Apple ID for store purchases (including iTunes in the Cloud and iTunes Match). You will get all the benefits of iCloud whether you use the same Apple ID for iCloud and store purchases, or different IDs for each.

Source: <http://support.apple.com/kb/HT4895>

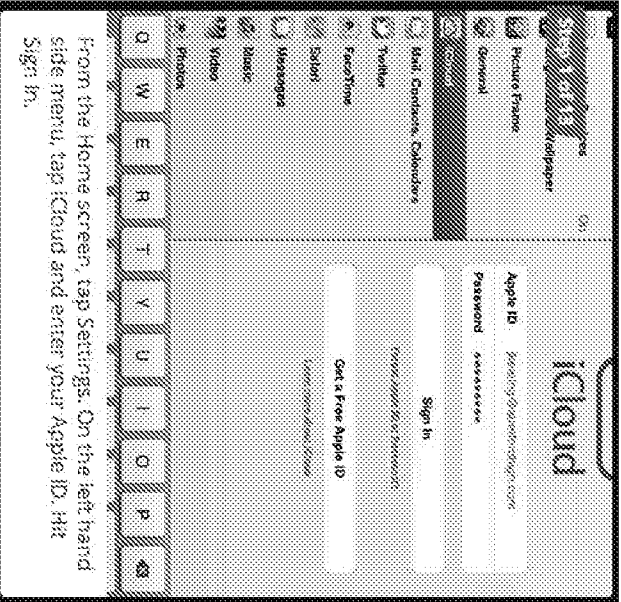

Source: <http://snapguide.com/guides/setup-icloud-back-up-use-locate-my-iphone/>

Claim 1

authenticating the verification token;

Technological Example

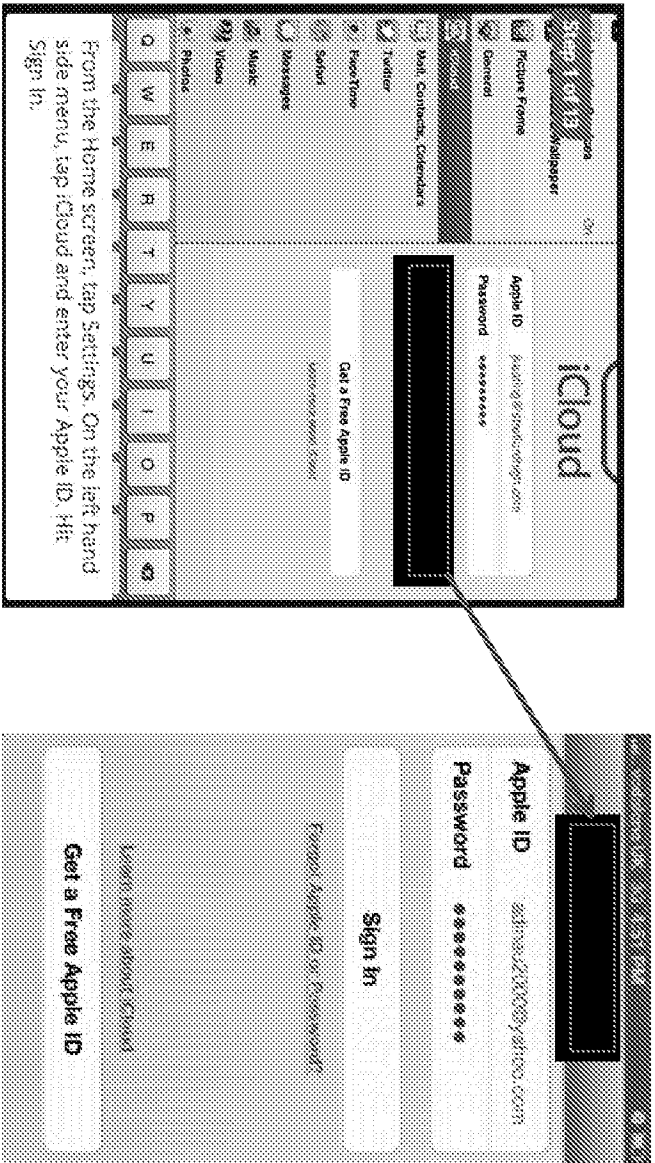

Source: <http://snapguide.com/guides/setup-icloud-back-up-use-locate-my-iphone/>  
Source: <http://www.lovetone.co.uk/blog/setting-up-an-icloud-account-more/>

### Claim 1

establishing a connection with the at least one communications console, wherein the communications console is a combination of a graphic user interface (GUI) and an Application Programmable Interface (API) wherein the API is a verified web service, the web service capable of facilitating a two way data exchange session to complete a verification process wherein the data exchange session comprises at least one identification reference;

### Technological Example

**3**  
**Customize your settings.**  
Tap the Settings icon and select iCloud. Tap the On/Off switches to enable individual iCloud services. To enable iCloud Backup, tap Storage & Backup and turn on iCloud Backup.

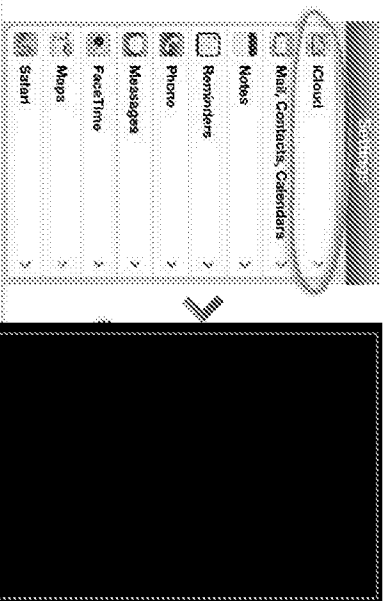

Source: <http://www.apple.com/icloud/setup/ios.html>

## Using iCloud Storage APIs with Your iOS and Mac Apps

*iCloud Storage APIs enable your apps to store content in iCloud, keeping your apps up to date automatically. Use iCloud to give your users a consistent and seamless experience across iCloud-enabled devices.*

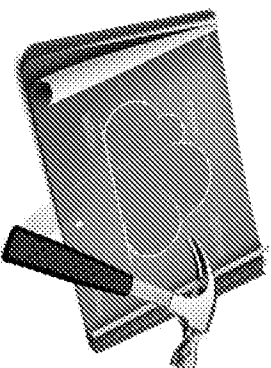

Source:

<https://developer.apple.com/icloud/index.php>

The `NSString` class creates UUID strings that are to uniquely identify types, interfaces, and other items. UUIDs (Universally Unique Identifiers), also known as GUIDs (Globally Unique Identifiers) or IDs (interface Identifiers), are 128-bit values. A UUID is made unique over both space and time by combining a value unique to the computer on which it was generated and a value representing the number of 100-nanosecond intervals since October 15, 1582 at 00:00:00.

Source: [http://developer.apple.com/library/ios/#documentation/Foundation/Reference/NSString\\_Class/Reference/Reference.html#//apple\\_ref/occ/clm/NSString/UUID](http://developer.apple.com/library/ios/#documentation/Foundation/Reference/NSString_Class/Reference/Reference.html#//apple_ref/occ/clm/NSString/UUID)

**Claim 1**

**Technological Example**

requesting at least one identification reference from the at least one communications console, wherein the identification reference comprises one or more of a verified web service account identifier, letter, number, rights token, email, password, access time, serial number, address, manufacturer identification, checksum, operating system version, browser version, credential, cookie, or key;

receiving the at least one identification reference from the at least one communications console; and

The `NSString` class creates UUID strings that are to uniquely identify types, interfaces, and other items. UUIDs (Universally Unique Identifiers), also known as GUIDs (Globally Unique Identifiers) or UUIDs (Interface Identifiers), are 128-bit values. A UUID is made unique over both space and time by combining a value unique to the computer on which it was generated and a value representing the number of 100-nanosecond intervals since October 15, 1582 at 00:00:00.

Source: [http://developer.apple.com/library/ios/#documentation/Foundation/Reference/NSString\\_Class/Reference/NSString.html#//apple\\_ref/occ/clm/NSString/UUID](http://developer.apple.com/library/ios/#documentation/Foundation/Reference/NSString_Class/Reference/NSString.html#//apple_ref/occ/clm/NSString/UUID)

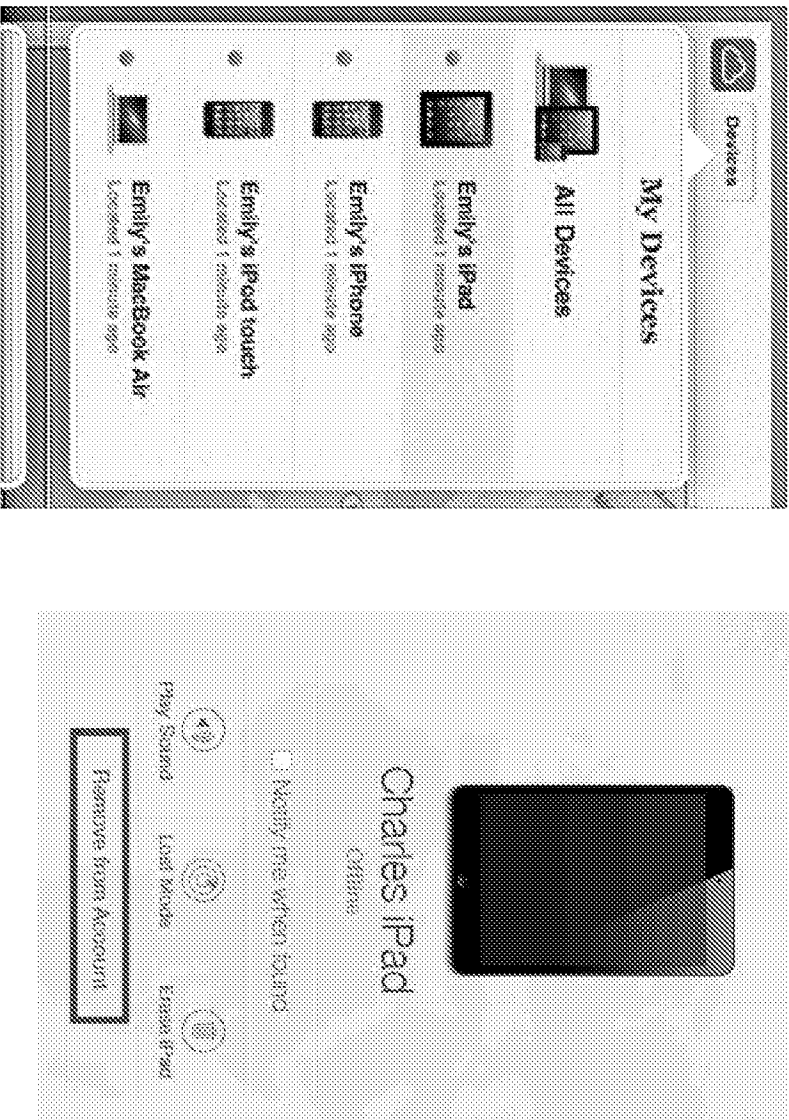

Source: [http://support.apple.com/kb/PH2698?viewlocale=en\\_US](http://support.apple.com/kb/PH2698?viewlocale=en_US)



**Claim 1**

writing at least one of the verification token or the identification reference into the metadata.

**Technological Example**

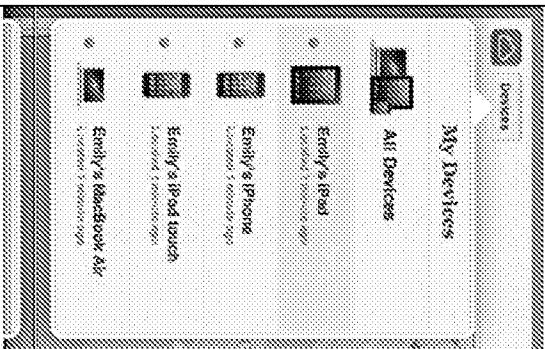

Source: [http://support.apple.com/kb/PH2698?viewlocale=en\\_US](http://support.apple.com/kb/PH2698?viewlocale=en_US)

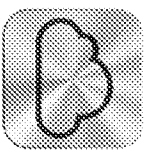

**iCloud**

iCloud does more than store your content — it lets you access your music, photos, calendars, contacts, documents, and more, from whatever device you're on. And it's built into every new iOS device and every new Mac. Learn more >

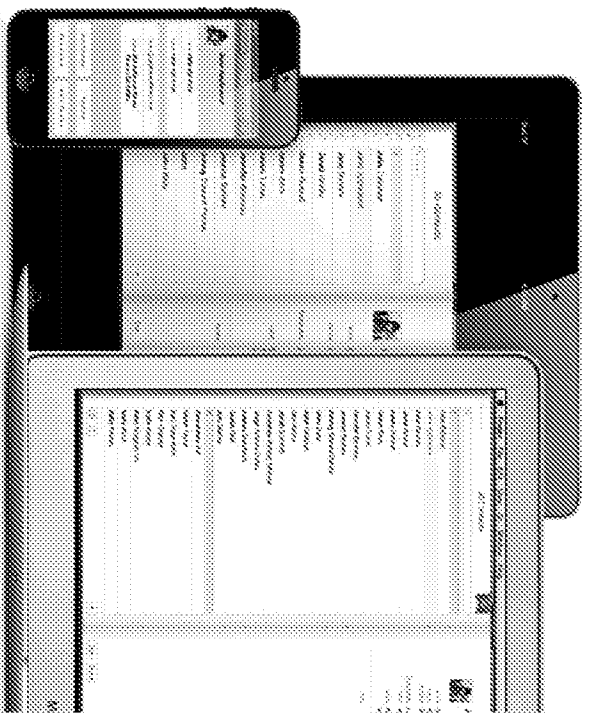

Your contacts on all your devices.

Source: <http://www.apple.com/icloud/>

**Claim 2**

The method according to claim 1, wherein the access request being a request from the first user through a data processing device of the plurality of data processing devices; or wherein the access request being a request from one or more secondary users in network to the first user; wherein the secondary users are validated by a membership web service.

**Technological Example**

*iCloud puts your content on all your devices.*

*Everywhere. Automatically. That's the way it should be, and iCloud makes it a reality. So when you buy a song, you don't have to download it over and over to enjoy it on multiple devices. Or worry that a document doesn't contain your latest revisions. Or spend time transferring photos. iCloud takes care of everything for you. Just like that.*

© 2011 Apple Inc.



Source: <http://www.apple.com/icloud/>

**Claim 3**

The method according to claim 2, wherein the metadata comprises one or more of a software or contents of a web page.

**Technological Example**

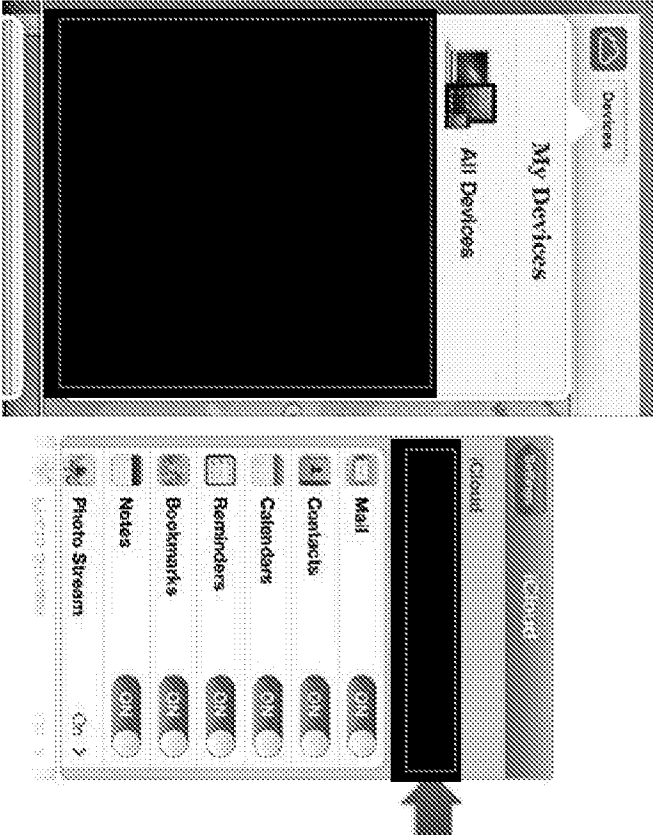

Source: [http://support.apple.com/kb/PH2698?viewlocale=en\\_US](http://support.apple.com/kb/PH2698?viewlocale=en_US)  
Source: <http://help.apple.com/icloud/#mm8e44092d>

**Claim 4**

**Technological Example**

The method according to claim 3, wherein the verification token represents verification from a provider of the token to grant access rights to the first user.

An Apple ID is the email address you use as a login for just about everything you do with Apple, including using iCloud to store your content, buying songs from the iTunes Store, and downloading apps from the App Store.

When you set up your iPhone, iPad, or iPod touch, you can use the same Apple ID for iCloud services and purchases on the iTunes Store, App Store, and Bookstore. You can also use one Apple ID for iCloud services and another Apple ID for store purchases (including iTunes in the Cloud and iTunes Match). You will get all the benefits of iCloud whether you use the same Apple ID for iCloud and store purchases, or different IDs for each.

Source: <http://support.apple.com/kb/HT4895>

**2**

**Turn on iCloud.**

When you turn on a new iOS device or after you've completed the update to the latest version of iOS, follow the instructions in the setup assistant to activate your device and set up iCloud.

If you skipped the setup process, tap the Settings icon on the Home screen, select iCloud, then enter your Apple ID.

Want to use a different Apple ID for iTunes? [Learn more](#) >

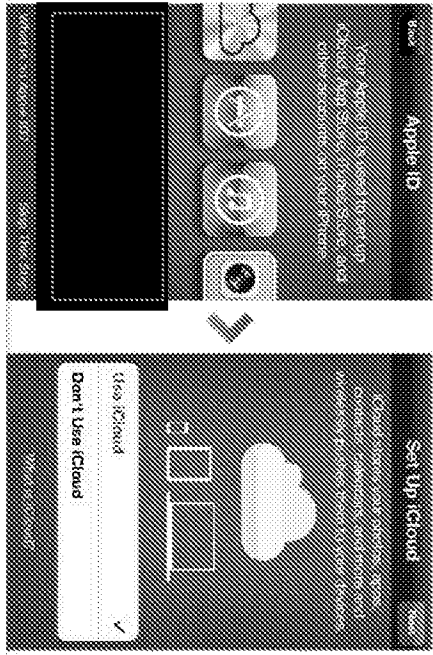

Source: <http://www.apple.com/icloud/setup/ios.html>

**Claim 5**

The method according to claim 3, wherein the digital content is shared among one or more users according to a membership status.

**Technological Example**

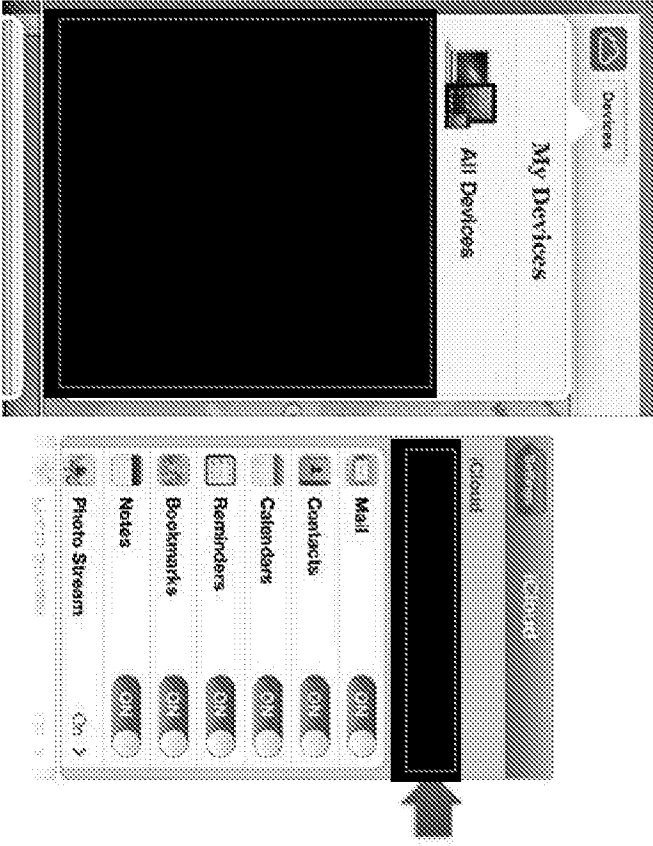

Source: [http://support.apple.com/kb/PH2698?viewlocale=en\\_US](http://support.apple.com/kb/PH2698?viewlocale=en_US)  
Source: <http://help.apple.com/icloud/#mm8e44092d>

**Claim 6**

The method according to claim 5, wherein the one or more users are a network of recognized human beings using machines or recognized automated computerized mechanisms programmed by human beings, the recognition of the one or more users being validated by the membership status of the membership web service.

**Technological Example**

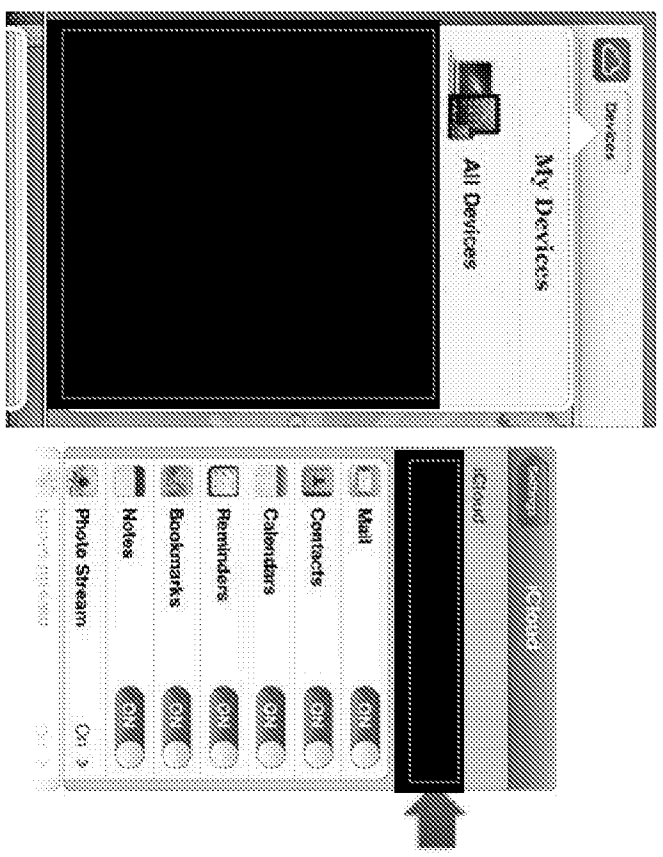

Source: [http://support.apple.com/kb/PH2698?viewlocale=en\\_US](http://support.apple.com/kb/PH2698?viewlocale=en_US)  
Source: <http://help.apple.com/icloud/#mm8e44092d>

**Claim 7**

The method according to claim 6, wherein the digital content access request is from a user using at least one of a computer or a phone hosting an operating system running an application.

**Technological Example**

iCloud does more than store your content ... it lets you access your music, photos, calendars, contacts, documents, and more, from whatever device you're on. And it's built into every new iOS device and every new Mac. Learn more >

iCloud

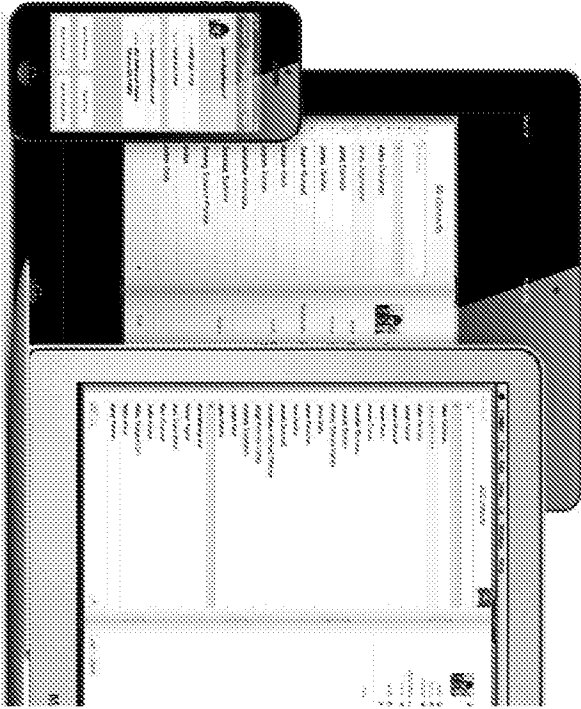
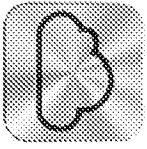

Your contacts on all your devices.

Source: <http://www.apple.com/icloud/>

**Claim 8**

The method of claim 7, wherein the verification token comprises at least one token selected from the group consisting of a purchase permission, a rental permission, or a membership permission; wherein the at least one of purchase permission, rental permission, or membership permission is represented by one or more of a letter, number, combination of letters and numbers, rights token, successful payment reference, phrase, name, membership credentials, image, logo, tag, service name, authorization, list, interface button, downloadable program, or an instrument of trade.

**Technological Example**

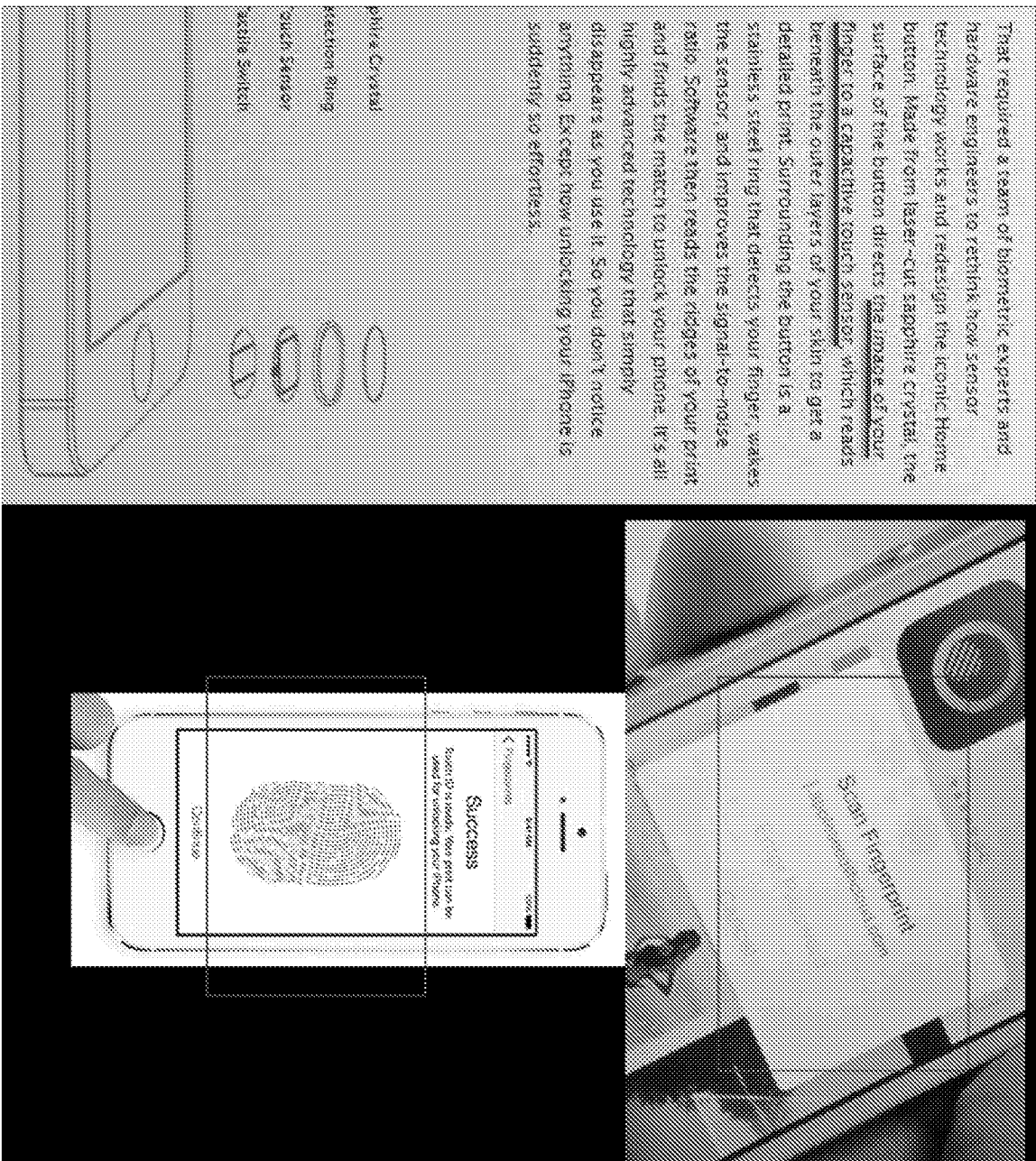

Source: <http://www.apple.com/iphone-5s/design/>

Source top: <http://www.apple.com/iphone-5s/videos/#video-touch>

Source bottom: <http://www.apple.com/iphone-5s/features/>



**U.S. Patent 8,533,860: Sony Entertainment Network**

**Claim 1**

A method for authorizing access to digital content using a cloud system, the cloud system comprising connected modules in operation as one or more of a cloud computing or a cloud storage in connection with devices and users, wherein the digital content is at least one of encrypted or not encrypted, the method facilitating access rights between a plurality of data processing devices, the method comprising:

**Technological Example**

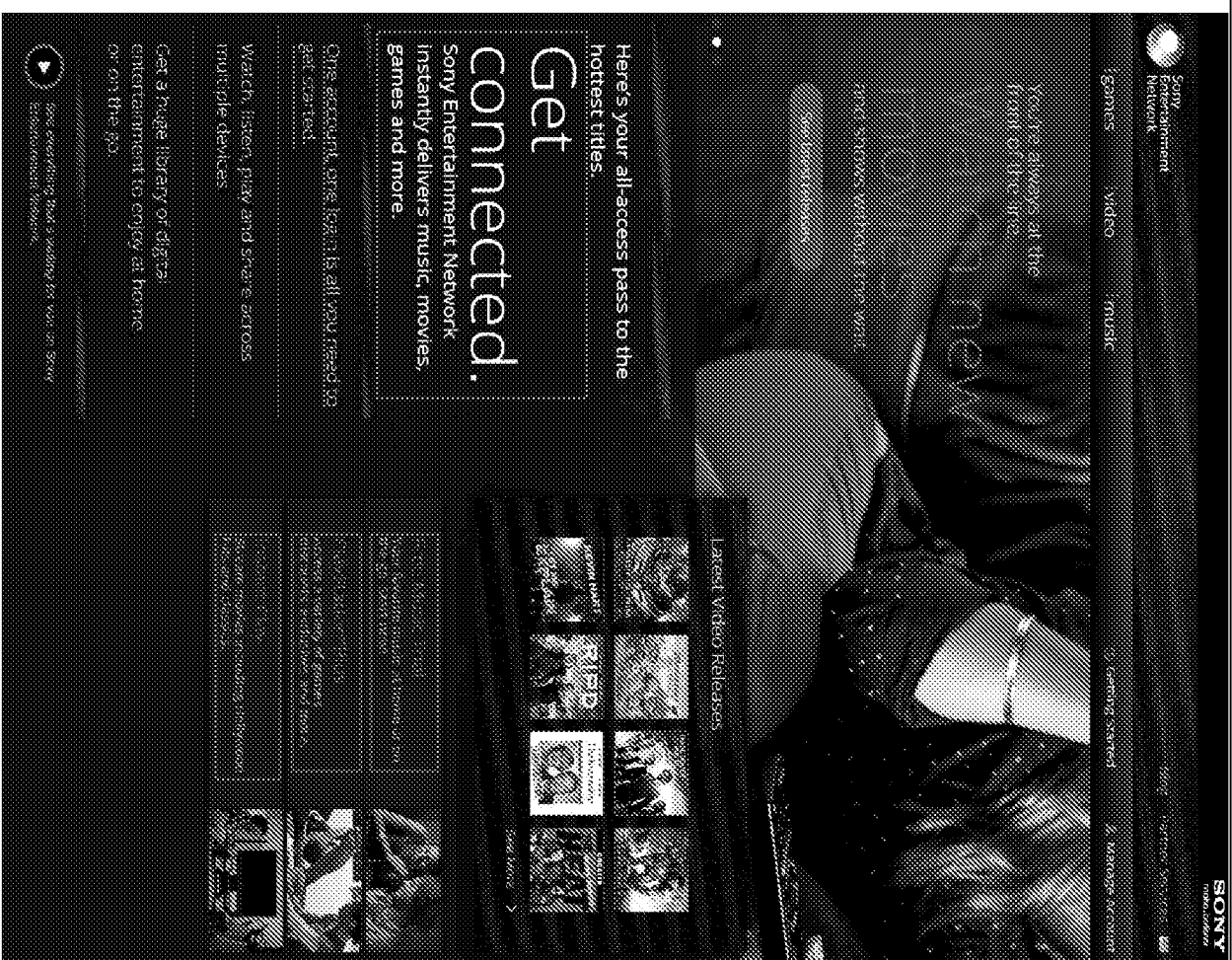

Source: <http://www.sonyentertainmentnetwork.com/home/>

**Claim 1**

**Technological Example**

Your compliance with all of the following are express conditions of Your license to use or access the Property. You may not sell, rent, lease, loan, sublicense, modify, adapt, arrange, translate, reverse engineer, decompile, or disassemble any portion of the Property. Except as stated in this Agreement or as SNEI expressly permits by SNEI, you may not reproduce or transfer any portion of the Property. You may not create any derivative works, attempt to create the source code from the object code, or download or use any Property for any purpose other than as expressly permitted. You may not bypass, disable, or circumvent any encryption, security, digital rights management or authentication mechanism in connection with SEN First Party Services, Authorized Devices, or any of the content or services offered through SEN First Party Services. You may use the Property only on Authorized Devices. You acknowledge that SEN First Party Services and content or services provided through SEN First Party Services may contain security or technical features that will prevent use of such content or services in violation of this Agreement. Property is not licensed to you for resale, public performance, display, distribution or broadcast. Except as this Agreement expressly grants, SNEI and its licensors reserve all rights, interests, and remedies in connection with SEN First Party Services and the Property. Upon termination of this Agreement, Your Account, or license to any Property, You will immediately cease use of the Property and delete or destroy copies of the Property.

Source: <http://www.sonyentertainmentnetwork.com/terms-of-service/>

Claim 1

receiving a digital content access request from at least one communications console of the plurality of data processing devices, the access request being a read or write request of metadata of the digital content, wherein the read or write request of metadata is performed in connection with a combination of at least one device and the cloud system, the request comprising a verification token provided by a first user corresponding to the digital content, wherein the verification token is one or more of a password, e-mail address, payment system, credit card, authorize ready device, rights token, or one or more redeemable instruments of trade;

Technological Example

**If you have forgotten or want to change your SEN account password**

If you can't sign in to your Sony Entertainment Network account because you have forgotten your password or if you'd like to change it for security reasons, you can do so via your PS3, PS Vita or PSP system, or by using a PC connected to the Internet. For information on changing a sub-account password, please click here.

**IMPORTANT:**

- You will email you a link to reset your password. If you have forgotten your password and you do not have access to the email address you use as your Sign-In ID (Email Address)? Do not attempt to reset your password. Instead, contact us for further assistance.
- We will also ask for the date of birth you entered when you created your account. If you do not know the date of birth used do not attempt to reset your password. Instead, contact us for further assistance.

Please click on the device you are using for instructions on how to retrieve or change your password.

PC  
PS3  
PS Vita  
PSP

I don't have access to the email address associated with my account - what should I do?  
If you do not have access to the email address associated with your account, or are unable to successfully set a new password using the methods provided, please click here to find out if you can change your Sign-In ID (Email Address).  
If you can't change your Sign-In ID (Email Address), please Contact Us for further assistance.  
I have not received a password reset email - what should I do?

**PlayStation Support Survey**  
TAKE SURVEY (1/11)

Thanks for using us today, we'd love to get your feedback on our service. It's only a short survey and your opinion is really important to us.

**Quick Links**

- Return to PS3s
- Ask a Question
- Email Article
- Email Article

**Related Articles**

- Contact Us
- If you have forgotten or want to change your SEN sign-in ID
- Change Sub Account Password
- Change ID
- Common solutions for trouble accessing the PS3™ (1/1/2013)

Source: [http://faq.en.playstation.com/app/answers/detail/a\\_id/5602](http://faq.en.playstation.com/app/answers/detail/a_id/5602)

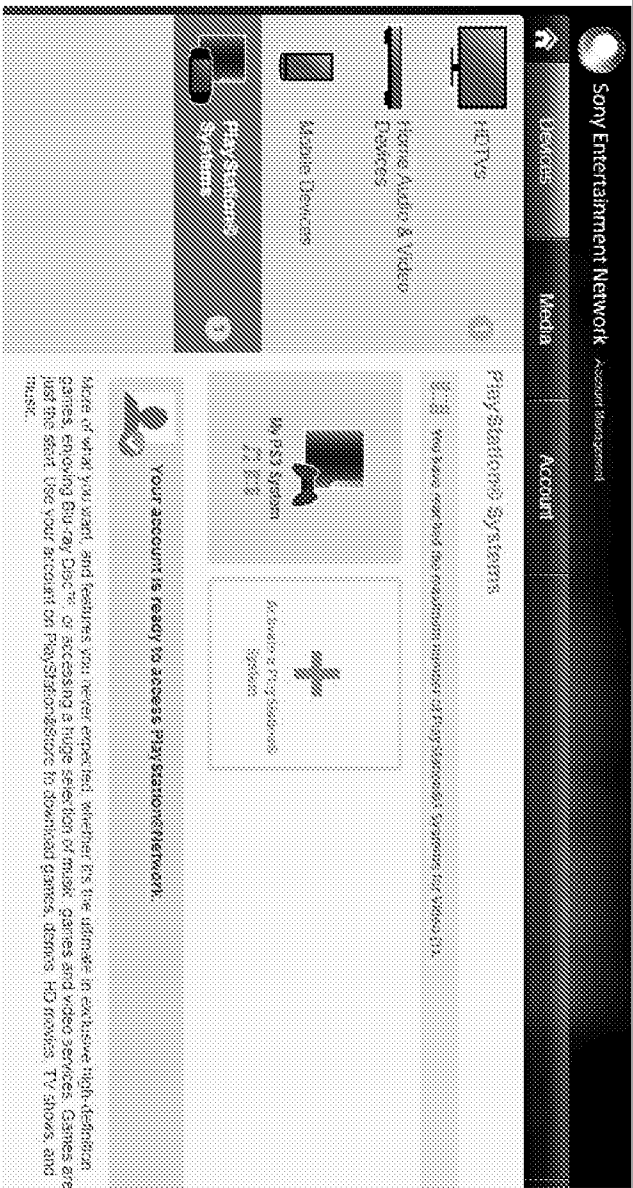

Source: [https://account.sonyentertainmentnetwork.com/liquid/cam/devices/device-](https://account.sonyentertainmentnetwork.com/liquid/cam/devices/device-list.action?category=psn&displayNavigation=false)  
[list.action?category=psn&displayNavigation=false](https://account.sonyentertainmentnetwork.com/liquid/cam/devices/device-list.action?category=psn&displayNavigation=false)

authenticating the verification token;

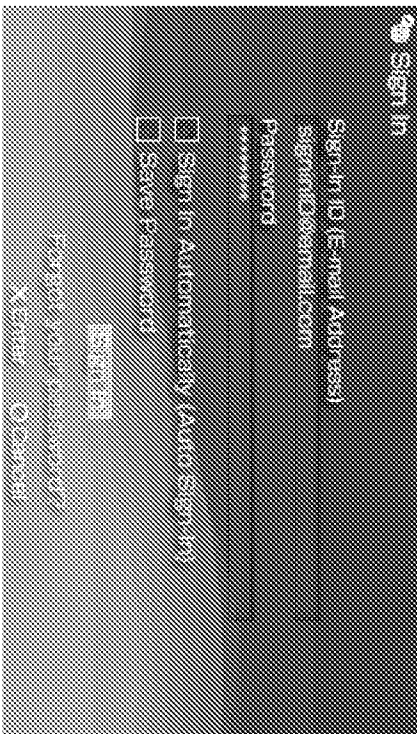

Source: PlayStation 3

Video Unlimited Enters My HDTV

How do I activate (link) an HDTV to my account?

Related Products & Categories

Once your HDTV is activated on your Sony Entertainment Network account you can access SEN or 3rd party services (subject to membership and service terms and conditions) directly through your HDTV.

You can link either up to 4 or up to 16 SEN accounts to your BRAVIA® depending on the model. You will be able to tell which link is available from the Link Account screen at the number of spaces the accounts will correspond with the link.

First of all please check that your TV is SEN enabled by checking the features of your device on Sony.com and set up a Sony Entertainment Network account via [sonyentertainmentnetwork.com](http://sonyentertainmentnetwork.com).

To link your HDTV to your account simply follow these steps:

1. Connect your HDTV to the internet.
2. Select the SEN icon on the bar left of the VWD™ Menu (this is the device home menu). If this icon does not appear, please check the Service Status on [sonyentertainmentnetwork.com](http://sonyentertainmentnetwork.com) as maintenance may be restricting your network access and check that your device firmware is up to date - you can find latest firmware information on [Sony.com](http://Sony.com).
3. If your BRAVIA® model includes the option to Link Account select this option and follow the on screen prompts to link your account. You can now use network services!
4. On a computer or mobile device connected to the internet sign in to your Sony Entertainment Network account. Go to the 'Devices' tab and select HDTV's from the left of the screen and click on '+ activate a device'.
5. Enter the activation code from your TV and the space provided.
5. Follow the instructions and choose your device PIN.
7. You can now use network services!

If you see a message on your device asking you to update your Sony Essentials account, this means that your device has been registered through the previous Essentials system. If you are unable to upgrade your account to a Sony Entertainment Network account from the Sony Essentials website please contact us for assistance.

If your activation code is not working for another reason please contact us for help.

Source:

[http://us.support.sonyentertainmentnetwork.com/app/answers/detail/a\\_id/695/session/L3RpbWUvMTM4MjM1NjZlOjZaM0VlT1BcW9sRGVw%3D](http://us.support.sonyentertainmentnetwork.com/app/answers/detail/a_id/695/session/L3RpbWUvMTM4MjM1NjZlOjZaM0VlT1BcW9sRGVw%3D)

**Claim 1**

establishing a connection with the at least one communications console, wherein the communications console is a combination of a graphic user interface (GUI) and an Application Programmable Interface (API) wherein the API is related to a verified web service, the web service capable of facilitating a two way data exchange session to complete a verification process wherein the data exchange session comprises at least one identification reference;

**Technological Example**

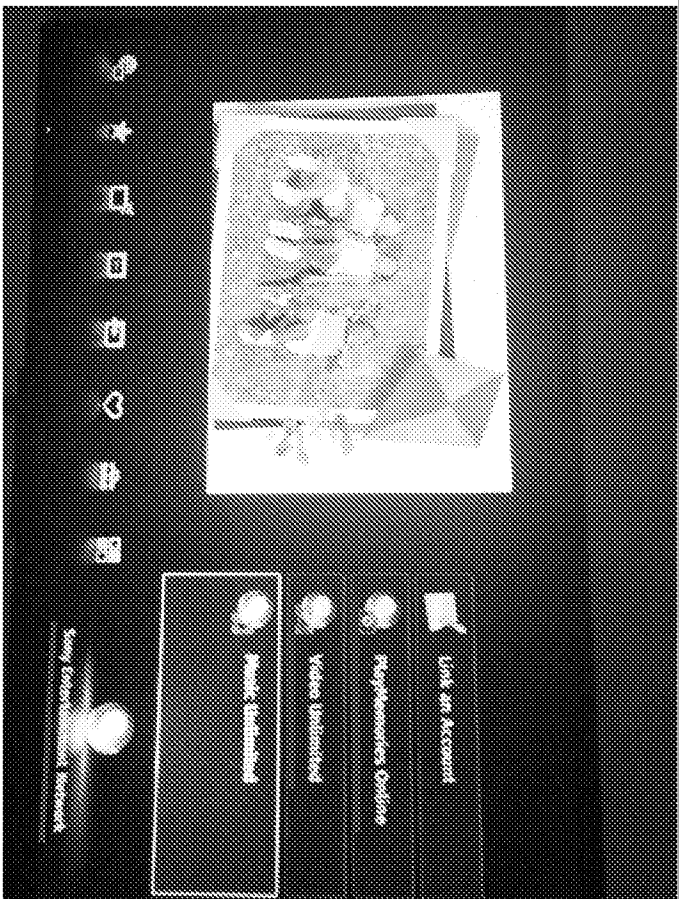

Source: Sony Bravia HDTV

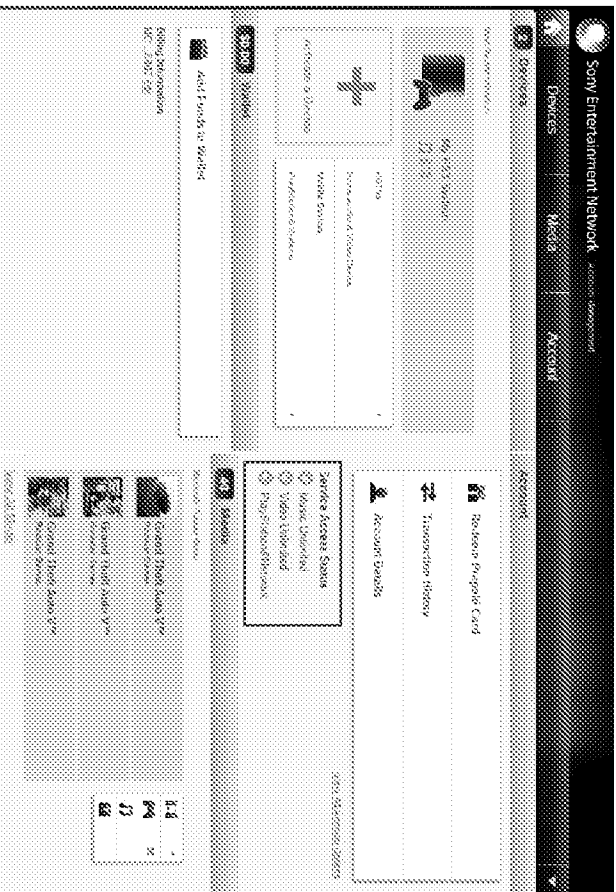

Source: SEN Account Manager

Software Engineer in Test - SNET - SF Job Listing at Sony Electronics in San Francisco, CA  
View on sonyelectronics.com

**SONY**

**Sony Electronics**

Location: San Francisco, CA  
 Posted: 10/10/2013  
 Reference ID: 2412613  
 Application deadline: None  
 Type: Not specified  
 Career Level: Not specified  
 Salary Range: Not specified  
 Number of Jobs: 1  
 Relocation Available: No  
 Shows all jobs for Sony Electronics

Push the button to see who you know here.

Send this job.

Close (x)

Send

Product: **Electronics, Semiconductors**

**Description**

Title: **Software Engineer in Test - SNET - SF**  
 Location: **San Francisco**  
 Job Number: **24874**

Do you have experience with Java or other test automation? Do you have experience designing and implementing one or more JUnit testing frameworks?

**Sony** the world's international network of R&D, SNET, a subsidiary of Sony Corporation in America, is the premier provider of digital entertainment. Through the **Sony Entertainment Network (SEN)**, consumers around the world are able to access their favorite digital entertainment content and to share it on their favorite content-rich devices. SNET offers the latest and highest quality music, video, and game content through Sony Entertainment Network as well as PlayStation Network, while also delivering third-party services. In addition, SNET provides a compelling, customized experience through innovative content discovery features and a simple yet powerful user interface.

Software Engineer in Test  
 San Francisco, CA

Job Summary: This

Software Engineer in Test will be part of newly formed Entertainment Network Software group, responsible for delivering cloud native software for Sony devices. This position is responsible for building and supporting test cases from ground zero to ensure various aspects of software services. You will have the opportunity to work with very talented engineers and also get a chance to work with cutting edge cloud based technologies.

Source: <http://www.twinkljobs.com/sony-electronics-jobs-software-engineer-in-test-snet-sf-11599429>



Get alerts for jobs like this:

Software Engineer in Test - SNET - SF

Electronics

San Francisco, CA



Email



Profile



Twitter

Send me job alerts

Get jobs like this tweeted to you:

Software Dev - IT/analyst Jobs in Test  
 San Francisco, CA

Feedback

View similar jobs:

Program Manager - San Francisco, CA  
 Quality Assurance - San Francisco, CA  
 Software Engineer in Test - San Francisco, CA  
 Software Engineer in Test - San Francisco, CA

Locate this job:

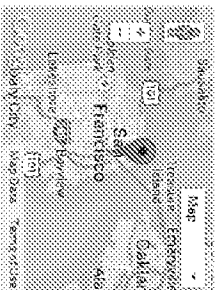

**Claim 1**

requesting the at least one identification reference from the at least one communications console, wherein the identification reference comprises one or more of a verified web service account identifier, letter, number, rights token, e-mail, password, access time, serial number, address, manufacturer identification, checksum, operating system version, browser version, credential, cookie, or key; receiving the at least one identification reference from the at least one communications console; and

**Technological Example**

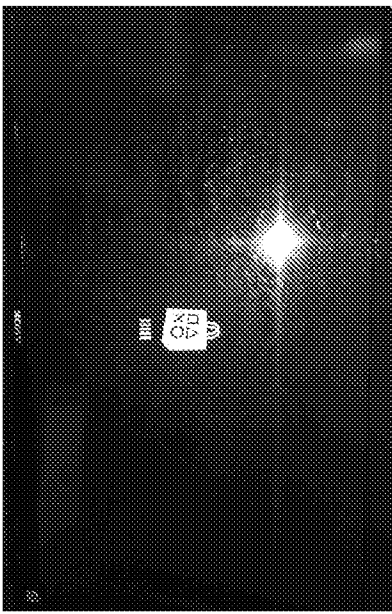

Source: PS3

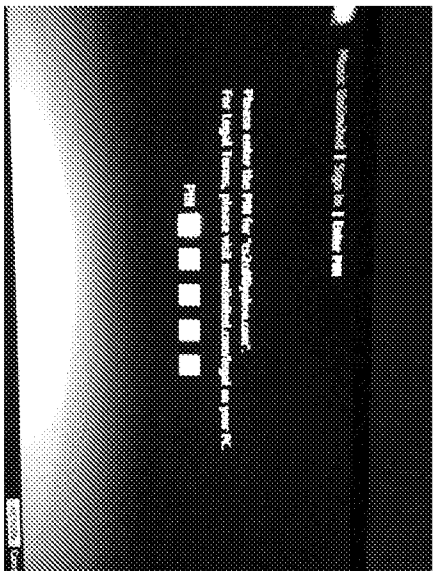

Source: Sony Bravia HDTV

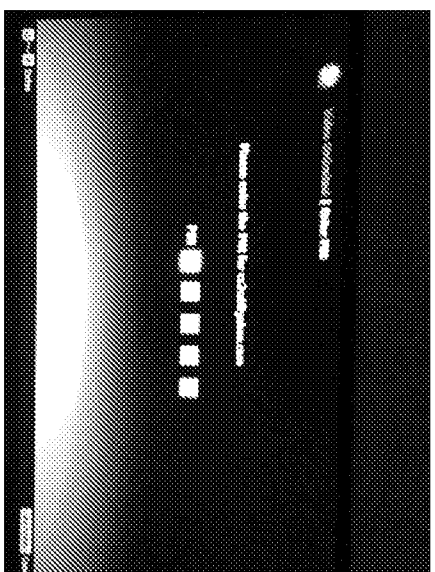



**Claim 1**

writing at least one of the verification token or the identification reference into the metadata.

**Technological Example**

Watch Movies Everywhere

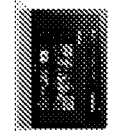
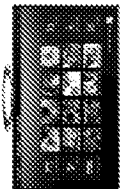
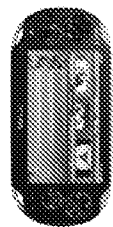

Watch Movies On

- ◊ Browse Televisions
- ◊ Blu-ray Disc™ Players
- ◊ Blu-ray Home Theater Systems
- ◊ PlayStation®3 Systems\*
- ◊ PS Vita\*
- ◊ PSP®
- ◊ Sony Bravia™ TV powered by Google TV
- ◊ Sony Netbox
- ◊ Sony Talkies
- ◊ Windows-based PCs through Media Go
- ◊ Xperia™ Mobile Phones

Source: <http://www.sonyentertainmentnetwork.com/video-unlimited/watch-movies/>

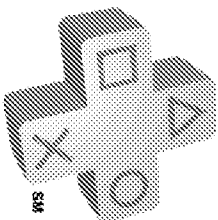

**PlayStation®Plus**

**PlayStation®Plus**

Introducing the new PlayStation®Plus, the membership service designed to bring games and gamers together, and fuel the next generation of gaming on the PS4™ system. PlayStation®Plus helps you discover a world of extraordinary gaming experiences through the ever-expanding collection of great games that members receive access to as part of their membership. With PlayStation®Plus on the PS4™ system, you'll also discover a world of like-minded gamers to play with and challenge, connected through an all-new multiplayer service worthy of the next generation.

Source: <http://us.playstation.com/ps4/index.htm>

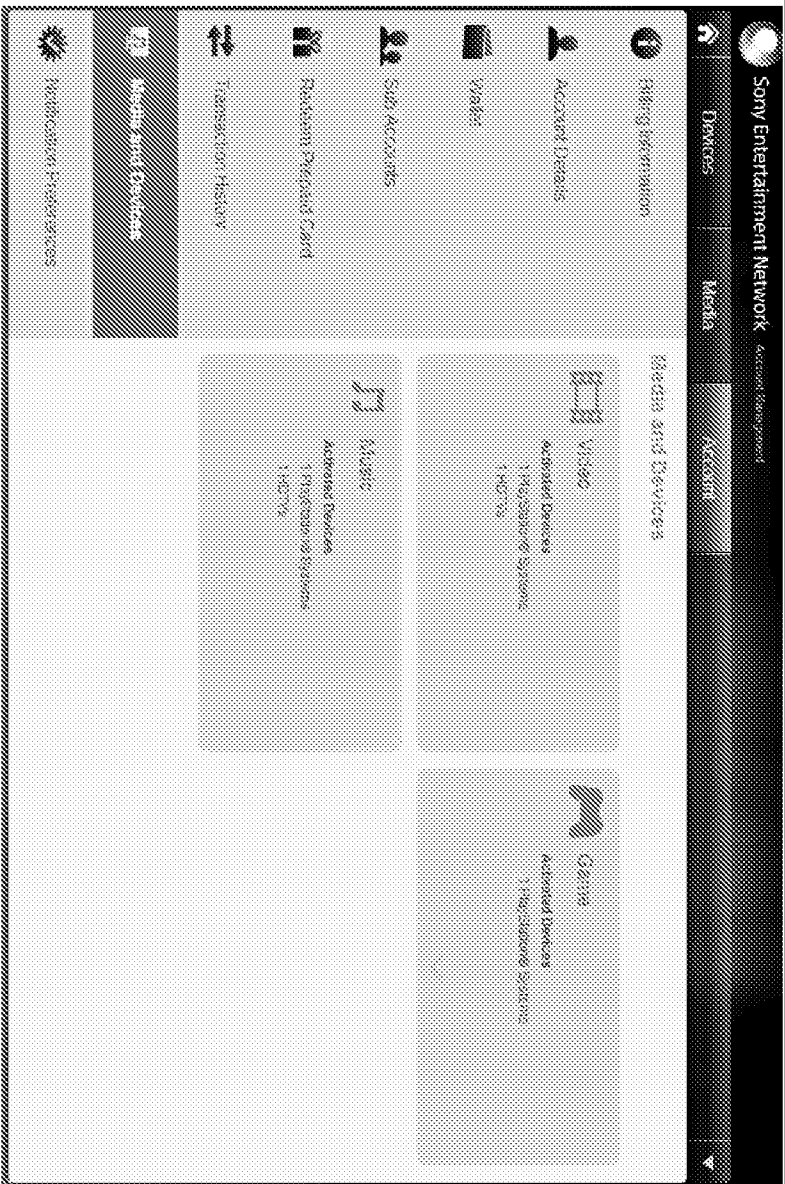

Source: <https://account.sonyentertainmentnetwork.com/liquid/cam/devices/device-media-list.action?displayNavigation=false>

**Claim 2**

The method according to claim 1, wherein the access request being a request from the first user through a data processing device of the plurality of data processing devices; or wherein the access request being a request from one or more secondary users in network to the first user; wherein said secondary users are validated by a membership web service.

**Technological Example**

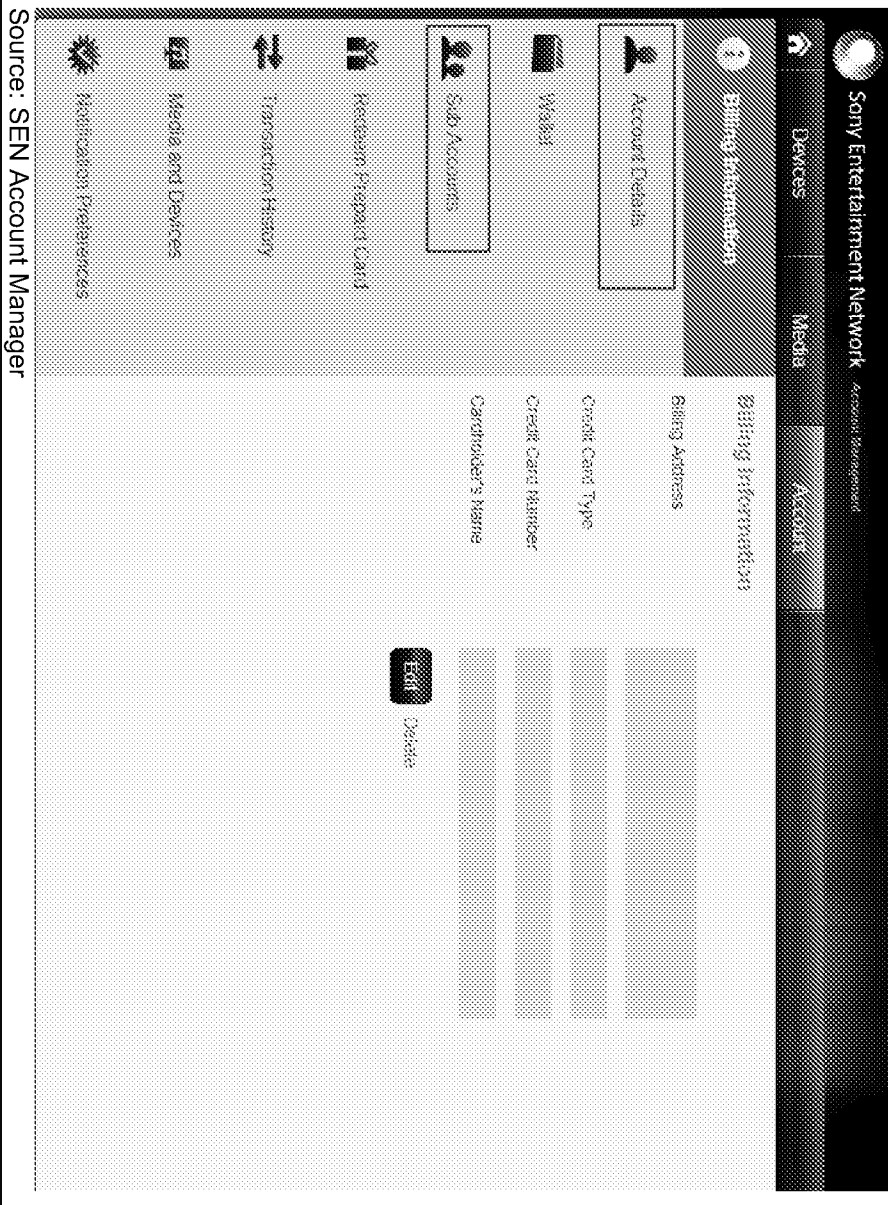

**Claim 3**

The method according to claim 2, wherein the metadata comprises one or more of a software or contents of a web page.

**Technological Example**

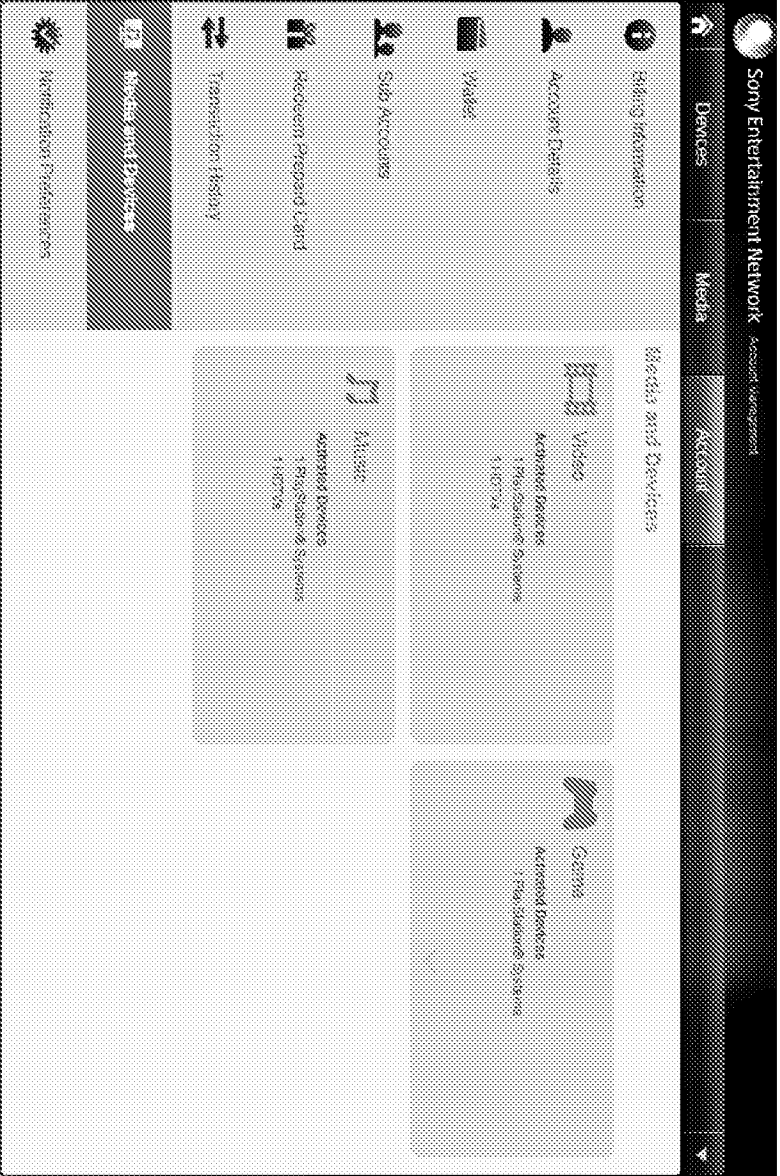

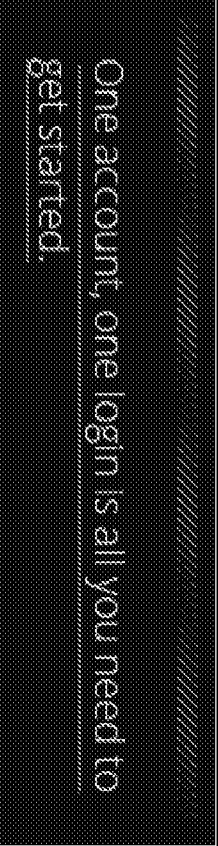
<p><b>Claim 4</b></p> <p>The method according to claim 3, wherein the verification token represents verification from a provider of the token to grant access rights to the first user.</p>	<p><b>Technological Example</b></p>  <p>Source: <a href="http://www.sonyentertainmentnetwork.com/home/">http://www.sonyentertainmentnetwork.com/home/</a></p>
---	---

EWS-003659

<p><b>Claim 5</b></p> <p>The method according to claim 3, wherein the digital content is shared among one or more users according to a membership status.</p>	<p><b>Technological Example</b></p>  <p>Source: <a href="http://www.playstationlifestyle.net/2013/06/11/one-playstation-plus-account-on-ps4-will-allow-other-accounts-to-play-online-on-same-console/">http://www.playstationlifestyle.net/2013/06/11/one-playstation-plus-account-on-ps4-will-allow-other-accounts-to-play-online-on-same-console/</a></p>
---	--

## Electronic Acknowledgement Receipt

<b>EFS ID:</b>	19178599
<b>Application Number:</b>	13740086
<b>International Application Number:</b>	
<b>Confirmation Number:</b>	7081
<b>Title of Invention:</b>	PERSONALIZED DIGITAL MEDIA ACCESS SYSTEM - PDMAS PART II
<b>First Named Inventor/Applicant Name:</b>	William Grecia
<b>Customer Number:</b>	70984
<b>Filer:</b>	William Grecia
<b>Filer Authorized By:</b>	
<b>Attorney Docket Number:</b>	
<b>Receipt Date:</b>	31-MAY-2014
<b>Filing Date:</b>	11-JAN-2013
<b>Time Stamp:</b>	18:58:47
<b>Application Type:</b>	Utility under 35 USC 111(a)

### Payment information:

Submitted with Payment	no
------------------------	----

### File Listing:

Document Number	Document Description	File Name	File Size(Bytes)/ Message Digest	Multi Part /.zip	Pages (if appl.)
1	Miscellaneous Incoming Letter	examples.pdf	5207224 <small>b84b448276ac4e8f7cdac155a78ae1e12980a63c</small>	no	40

### Warnings:

### Information:

EWS-003660

**This Acknowledgement Receipt evidences receipt on the noted date by the USPTO of the indicated documents, characterized by the applicant, and including page counts, where applicable. It serves as evidence of receipt similar to a Post Card, as described in MPEP 503.**

**New Applications Under 35 U.S.C. 111**

**If a new application is being filed and the application includes the necessary components for a filing date (see 37 CFR 1.53(b)-(d) and MPEP 506), a Filing Receipt (37 CFR 1.54) will be issued in due course and the date shown on this Acknowledgement Receipt will establish the filing date of the application.**

**National Stage of an International Application under 35 U.S.C. 371**

**If a timely submission to enter the national stage of an international application is compliant with the conditions of 35 U.S.C. 371 and other applicable requirements a Form PCT/DO/EO/903 indicating acceptance of the application as a national stage submission under 35 U.S.C. 371 will be issued in addition to the Filing Receipt, in due course.**

**New International Application Filed with the USPTO as a Receiving Office**

**If a new international application is being filed and the international application includes the necessary components for an international filing date (see PCT Article 11 and MPEP 1810), a Notification of the International Application Number and of the International Filing Date (Form PCT/RO/105) will be issued in due course, subject to prescriptions concerning national security, and the date shown on this Acknowledgement Receipt will establish the international filing date of the application.**

AO 120 (Rev. 2/99)

<b>TO: Mail Stop 8</b> <b>Director of the U.S. Patent &amp; Trademark Office</b> <b>P.O. Box 1450</b> <b>Alexandria, VA 22313-1450</b>	<b>REPORT ON THE</b> <b>FILING OR DETERMINATION OF AN</b> <b>ACTION REGARDING A PATENT OR</b> <b>TRADEMARK</b>
---	---

In Compliance with 35 § 290 and/or 15 U.S.C. § 1116 you are hereby advised that a court action has been filed in the U.S. District Court Northern District California on the  Patents or  Trademarks:

DOCKET NO. CV 14-01220 JCS	DATE FILED 3/14/14	U.S. DISTRICT COURT 450 Golden Gate Avenue, 16 <sup>th</sup> Floor, San Francisco CA 94102
PLAINTIFF WILLIAM GRECIA		DEFENDANT VUDU INC ET AL
PATENT OR TRADEMARK NO.	DATE OF PATENT OR TRADEMARK	HOLDER OF PATENT OR TRADEMARK
1 8,533,860		***see Attach complaint***
2		
3		
4		
5		

In the above—entitled case, the following patent(s) have been included:

DATE INCLUDED	INCLUDED BY <input type="checkbox"/> Amendment <input type="checkbox"/> Answer <input type="checkbox"/> Cross Bill <input type="checkbox"/> Other Pleading		
PATENT OR TRADEMARK NO.	DATE OF PATENT OR TRADEMARK	HOLDER OF PATENT OR TRADEMARK	
1			
2			
3			
4			
5			

In the above—entitled case, the following decision has been rendered or judgement issued:

DECISION/JUDGEMENT
--------------------

CLERK Richard W. Wicking	(BY) DEPUTY CLERK Gina Augustine	DATE March 15, 2014
-----------------------------	-------------------------------------	------------------------



1 John Mansfield #214848  
john@mansfieldlaw.net  
2 **MansfieldLaw**  
1001 Bayhill Drive, 2nd Floor  
3 San Bruno, CA 94066  
971.271.8615  
4

5 Matthew M. Wawrzyn (pro hac vice pending)  
matt@wawrzynlaw.com  
6 Stephen C. Jarvis (pro hac vice pending)  
stephen@wawrzynlaw.com  
7 **WAWRZYN LLC**  
233 S. Wacker Dr., 84th Floor  
8 Chicago, IL 60606  
312.283.8330

9 *Attorneys for Plaintiff William Grecia*

10  
11 UNITED STATES DISTRICT COURT  
12 NORTHERN DISTRICT OF CALIFORNIA  
13

14 William Grecia,  
15 Plaintiff,  
16 v.  
17 VUDU, Inc. and Digital Entertainment  
Content Ecosystem (DECE) LLC,  
18 Defendants.  
19  
20  
21

CASE NO. **C14-1220 JCS**  
Complaint For Patent Infringement  
Jury Trial demanded

22 **ECF DOCUMENT**

23 I hereby attest and certify this is a printed copy of a  
document which was electronically filed with the United States  
District Court for the Northern District of California.

24 Date Filed: 3/14/14

25 RICHARD W. WIEKING, Clerk

26 By: GINA AGUSTINE, Deputy Clerk  
27  
28

**PARTIES**

1  
2  
3  
4  
5  
6  
7  
8  
9  
10  
11  
12  
13  
14  
15  
16  
17  
18  
19  
20  
21  
22  
23  
24  
25  
26  
27  
28

- 1. Plaintiff William Grecia lives in Downingtown, Pennsylvania.
- 2. Defendant VUDU is a corporation organized under the laws of Delaware, with its principal place of business located in Santa Clara, California.
- 3. Defendant DECE is a company organized under the laws of Delaware, with its principal place of business located in Pleasanton, California.

**Jurisdiction and Venue**

- 4. This action arises under the patent laws of the United States, 35 U.S.C. §§ 101 *et seq.*
- 5. This Court has subject matter jurisdiction over this action under 28 U.S.C. §§ 1331 and 1338(a).
- 6. This Court may exercise personal jurisdiction over VUDU and DECE, both of whom reside and conduct continuous and systematic business in California and this District. This patent-infringement claim arises directly from VUDU's and DECE's continuous and systematic activity in this District. In short, this Court's exercise of jurisdiction over VUDU and DECE would be consistent with the California long-arm statute and traditional notions of fair play and substantial justice.
- 7. Venue is proper in this District pursuant to 28 U.S.C. §§ 1391(b)(1) and 1400(b).

**Background**

- 8. William Grecia owns United States Patent 8,533,860 (the "'860 patent") and at least one continuing application claiming back to the original priority date of March 21, 2010. William Grecia invented the methods and products claimed in the '860 patent.
- 9. The field of the invention of the '860 patent is digital rights management, commonly referred to as "DRM." The movement of books, movies, and music to digital form has presented a challenge to the copyright owners of the content. The owners wish to sell the content in a digital form and transfer all attributes of ownership to the buyer, and yet the

1 owners of the content must protect value by preventing "pirating" of the content through  
2 illicit copying.

3 10. DRM schemes to date had locked the purchased content, a movie for example,  
4 to specific devices and in some cases limited playback rights to a single device. These prior  
5 art DRM methods required the content providers (a movie studio in the example) to maintain  
6 computer servers to receive and send session authorization keys to clients, and the prior  
7 DRM methods required that the client reconnect with the servers to obtain reauthorization.  
8 These DRM schemes may be characterized by limiting acquired content to a specific device  
9 that the client continually had to reauthorize to enjoy the acquired content.

10 11. The '860 invention provides a solution. With this invention, a consumer of  
11 digital content may enjoy the content on a multiple number of the consumer's devices and  
12 share the content with the consumer's friends and family, all while protecting against  
13 unlicensed use of the digital content.

14 **Count 1: Claim of Direct Patent Infringement by VUDU and DECE**

15 12. William Grecia is the exclusive owner of the '860 patent, which is attached as  
16 Exhibit 1.

17 13. The '860 patent is valid and enforceable.

18 14. VUDU and DECE, pursuant to a contractual or agency relationship, have and  
19 are directly infringing claims of the '860 patent. VUDU and DECE make, use, sell, and offer  
20 for sale methods, equipment, and services that practice claims 1, 2, 3, 4, 5, 9, and 10 of the  
21 '860 patent.

22 15. For example, and without limiting the claims of the '860 patent that will be  
23 asserted or the VUDU and DECE services that will be accused of infringing the '860 patent  
24 claims, VUDU and DECE's cloud computing service directly infringes claim 1 of the '860  
25 patent.

1           16. Claim 1 is “[a] method for authorizing access to digital content using a cloud  
2 system . . . .” VUDU and DECE practice a method of authorizing access to digital content—  
3 such as movies—using a cloud computing system.

4           17. The method of claim 1 is one “facilitating access rights between a plurality of  
5 data processing devices . . . .” VUDU and DECE facilitate access rights to movies between a  
6 plurality of devices.

7           18. According to the method of claim 1, a read or write request of metadata of the  
8 digital content is received. This request comprises a verification token of a user, such as, for  
9 example, the user’s email address or password. VUDU receives a content access request  
10 from the user’s device when the user requests access to her digital content by requesting  
11 that VUDU write her email address and password to metadata of the digital content.

12           19. In claim 1, after the verification token has been authenticated, a connection is  
13 established between a communications console and a server. The connection is established  
14 through a web service capable of facilitating a two-way exchange between the console and  
15 the server. After the VUDU user’s verification token has been authenticated, VUDU  
16 establishes a connection between the user’s device and DECE’s UltraViolet web services by  
17 presenting the UltraViolet login screen using UltraViolet’s coordinator Application  
18 Programmable Interface (“API”).

19           20. Next, claim 1 involves the step of requesting an identification reference, such  
20 as a verified web service account identifier. VUDU and DECE request an identification  
21 reference—the user’s Ultraviolet username and password—from the communications  
22 console.

23           21. Next, according to claim 1, the identification reference is received from the  
24 communications console. The VUDU and DECE service receives an identification reference.

25           22. Finally, claim 1 involves writing either the verification token or the  
26 identification reference into the metadata. VUDU and DECE write, among other things, the  
27

28

1 user's VUDU verification token or the DECE identification reference into the metadata  
2 associated with the digital content, authorizing the user access to her digital content.

3 23. VUDU and DECE have knowledge of the '860 patent. Among other things,  
4 DECE or individuals acting on DECE's behalf disclosed the '860 patent to the United States  
5 Patent and Trademark Office as relevant prior art in case 13/436,567.  
6

7 **Count 2: Claim of Indirect Patent Infringement by DECE**

8 24. DECE has knowledge of the '860 patent and nonetheless actively induces at  
9 least the following entities to directly infringe the '860 patent: VUDU, Target Corporation,  
10 Sony Pictures Entertainment Inc., Flixster, Inc., MediaNaviCo LLC, Barnesandnoble.com llc,  
11 Paramount Pictures Corporation, Paramount Home Entertainment, Inc., D.W. Studios L.L.C.,  
12 Paramount Vantage, NBCUNIVERSAL, INC., Best Buy Co., Inc., and BestBuy.com, LLC  
13 (collectively, the "Retailers," individually, the "Retailer").

14 25. DECE has a contractual or agency relationship with each Retailer. According to  
15 this relationship, DECE and the Retailer infringe claims of the '860 patent by together  
16 performing all steps in the infringed claims. DECE and the Retailer make, use, sell, and offer  
17 for sale methods, equipment, and services that practice claims 1, 2, 3, 4, 5, 9, and 10 of the  
18 '860 patent. DECE induces each of these infringements.

19 26. For example, and without limiting the claims of the '860 patent that will be  
20 asserted, DECE knowingly induces Target to directly infringe claim 1 of the '860 patent.

21 27. Claim 1 is "[a] method for authorizing access to digital content using a cloud  
22 system . . . ." Target and DECE practice a method of authorizing access to digital content—  
23 such as movies—using a cloud computing system.

24 28. The method of claim 1 is one "facilitating access rights between a plurality of  
25 devices . . . ." Target and DECE facilitate access rights to movies among a plurality of devices.

26 29. According to the method of claim 1, a read or write request of metadata of the  
27 digital content is received. This request comprises a verification token of a user, such as, for  
28

1 example, the user's email address and password. Target receives a content access request  
2 from the user's device when the user requests access to her digital content by requesting  
3 that Target write her email address or password to metadata of the digital content.

4 30. In claim 1, after the verification token has been authenticated, a connection is  
5 established between a communications console and a server. The connection is established  
6 through a web service capable of facilitating a two-way exchange between the console and  
7 the server. After the Target user's verification token has been authenticated, Target  
8 establishes a connection between the user's device and DECE's UltraViolet web services by  
9 presenting the UltraViolet login screen using UltraViolet's coordinator API.

10 31. Next, claim 1 involves the step of requesting an identification reference, such  
11 as a verified web service account identifier. Target and DECE request an identification  
12 reference—the user's Ultraviolet username and password—from the communications  
13 console.

14 32. Next, according to claim 1, the identification reference is received from the  
15 communications console. The Target and DECE service receives an identification reference.

16 33. Finally, claim 1 involves writing either the verification token or the  
17 identification reference into the metadata. Target and DECE write, among other things, the  
18 user's Target verification token or the DECE identification reference into the metadata  
19 associated with the digital content, authorizing the user access to her digital content.

20 34. Again, without limiting the claims that will be asserted in this action, DECE  
21 induces each of the Retailers defined above to directly infringe the '860 patent claims  
22 according to the contractual or agency relationship between DECE and the Retailer.

### 23 Prayer for Relief

24 WHEREFORE, William Grecia prays for the following relief against VUDU and DECE:

- 25 (a) Judgment that VUDU and DECE have directly infringed claims of the '860  
26 patent claims;

1  
2  
3  
4  
5  
6  
7  
8  
9  
10  
11  
12  
13  
14  
15  
16  
17  
18  
19  
20  
21  
22  
23  
24  
25  
26  
27  
28

- (b) Judgment that DECE has induced the Retailers to directly infringe the '860 patent claims;
- (c) For a fair and reasonable royalty;
- (d) For treble damages based on a finding that the infringement of the '860 patent claims was willful;
- (e) For pre-judgment interest and post-judgment interest at the maximum rate allowed by law;
- (f) For such other and further relief as the Court may deem just and proper.

**Demand for Jury Trial**

William Grecia demands a trial by jury on all matters and issues triable by jury.

Date: March 14, 2014

/s/ John Mansfield  
John Mansfield #214848  
john@mansfieldlaw.net  
**MansfieldLaw**  
1001 Bayhill Drive, 2nd Floor  
San Bruno, CA 94066  
971.271.8615

Matthew M. Wawrzyn (pro hac vice pending)  
matt@wawrzynlaw.com  
Stephen C. Jarvis (pro hac vice pending)  
stephen@wawrzynlaw.com  
**WAWRZYN LLC**  
233 S. Wacker Dr., 84th Floor  
Chicago, IL 60606  
312.283.8330

*Attorneys for Plaintiff William Grecia*

## **Exhibit 1**



AO 121 (6/90)

<b>TO:</b>  COMMISSIONER OF PATENTS AND TRADEMARKS (USPTO) P.O. Box 1450 Alexandria, VA 22313-1450	<b>REPORT ON THE                  FILING OF DETERMINATION OF AN ACTION OR APPEAL                  REGARDING A COPYRIGHT</b>
---	---

In compliance with the Act of July 19, 1952 (66 Stat. 814; 35 U.S.C. 290) you are hereby advised that a court action has been filed on the following patent(s) in the U.S. District Court:

<b>DOCKET</b> 13cv8733	<b>DATE FILED</b> 12/6/13	<b>UNITED STATES DISTRICT COURT, NORTHERN DISTRICT OF ILLINOIS, EASTERN DIVISION</b>
<b>PLAINTIFF</b> William Grecia		<b>DEFENDANT</b> Google Inc.
<b>PATENT NO.</b>	<b>DATE OF PATENT</b>	<b>PATENTEE</b>
8,533,860	9/10/13	William Grecia

In the above-entitled case, the following patent(s) have been included:

DATE INCLUDED	INCLUDED BY <input type="checkbox"/> Amendment <input type="checkbox"/> Answer <input type="checkbox"/> Cross Bill <input type="checkbox"/> Other Pleading		
<b>PATENT NO.</b>	<b>DATE OF PATENT</b>	<b>PATENT</b>	

In the above-entitled case, the following decision has been rendered or judgment issued:

DECISION/JUDGMENT		
<b>CLERK</b> Thomas G. Bruton	<b>(BY) DEPUTY CLERK</b> Maya Burke	<b>DATE</b> 12/12/13



UNITED STATES PATENT AND TRADEMARK OFFICE

UNITED STATES DEPARTMENT OF COMMERCE  
United States Patent and Trademark Office  
Address: COMMISSIONER FOR PATENTS  
P.O. Box 1450  
Alexandria, Virginia 22313-1450  
www.uspto.gov

APPLICATION NO.	FILING DATE	FIRST NAMED INVENTOR	ATTORNEY DOCKET NO.	CONFIRMATION NO.
12/766,337	04/23/2010	Scott Ryder	P8690US1/14280US.1	1214
47743	7590	03/20/2014	EXAMINER	
WOMBLE CARLYLE SANDRIDGE & RICE LLP			KOSOWSKI, CAROLYN M	
Attn: IP Docketing			ART UNIT	
P. O. BOX 7037			PAPER NUMBER	
ATLANTA, GA 30357-0037			2431	
			NOTIFICATION DATE	
			DELIVERY MODE	
			03/20/2014	
			ELECTRONIC	

**Please find below and/or attached an Office communication concerning this application or proceeding.**

The time period for reply, if any, is set in the attached communication.

Notice of the Office communication was sent electronically on above-indicated "Notification Date" to the following e-mail address(es):

IPDocketing@WCSR.com

### Office Action Summary

Application No.  
12/766,337

Applicant(s)  
RYDER, SCOTT

Examiner  
CAROLYN B. KOSOWSKI

Art Unit  
2431

AIA (First Inventor to File)  
Status  
No

-- The MAILING DATE of this communication appears on the cover sheet with the correspondence address --

#### Period for Reply

A SHORTENED STATUTORY PERIOD FOR REPLY IS SET TO EXPIRE 3 MONTHS FROM THE MAILING DATE OF THIS COMMUNICATION.

- Extensions of time may be available under the provisions of 37 CFR 1.136(a). In no event, however, may a reply be timely filed after SIX (6) MONTHS from the mailing date of this communication.
- If NO period for reply is specified above, the maximum statutory period will apply and will expire SIX (6) MONTHS from the mailing date of this communication.
- Failure to reply within the set or extended period for reply will, by statute, cause the application to become ABANDONED (35 U.S.C. § 133). Any reply received by the Office later than three months after the mailing date of this communication, even if timely filed, may reduce any earned patent term adjustment. See 37 CFR 1.704(b).

#### Status

- 1)  Responsive to communication(s) filed on 5/23/13.  
 A declaration(s)/affidavit(s) under **37 CFR 1.130(b)** was/were filed on \_\_\_\_\_.
- 2a)  This action is **FINAL**.                      2b)  This action is non-final.
- 3)  An election was made by the applicant in response to a restriction requirement set forth during the interview on \_\_\_\_\_; the restriction requirement and election have been incorporated into this action.
- 4)  Since this application is in condition for allowance except for formal matters, prosecution as to the merits is closed in accordance with the practice under *Ex parte Quayle*, 1935 C.D. 11, 453 O.G. 213.

#### Disposition of Claims\*

- 5)  Claim(s) 1-15,19 and 20 is/are pending in the application.  
5a) Of the above claim(s) \_\_\_\_\_ is/are withdrawn from consideration.
- 6)  Claim(s) \_\_\_\_\_ is/are allowed.
- 7)  Claim(s) 1-15,19 and 20 is/are rejected.
- 8)  Claim(s) \_\_\_\_\_ is/are objected to.
- 9)  Claim(s) \_\_\_\_\_ are subject to restriction and/or election requirement.

\* If any claims have been determined allowable, you may be eligible to benefit from the **Patent Prosecution Highway** program at a participating intellectual property office for the corresponding application. For more information, please see [http://www.uspto.gov/patents/init\\_events/pph/index.jsp](http://www.uspto.gov/patents/init_events/pph/index.jsp) or send an inquiry to [PPHfeedback@uspto.gov](mailto:PPHfeedback@uspto.gov).

#### Application Papers

- 10)  The specification is objected to by the Examiner.
- 11)  The drawing(s) filed on \_\_\_\_\_ is/are: a)  accepted or b)  objected to by the Examiner.  
Applicant may not request that any objection to the drawing(s) be held in abeyance. See 37 CFR 1.85(a).  
Replacement drawing sheet(s) including the correction is required if the drawing(s) is objected to. See 37 CFR 1.121(d).

#### Priority under 35 U.S.C. § 119

- 12)  Acknowledgment is made of a claim for foreign priority under 35 U.S.C. § 119(a)-(d) or (f).

#### Certified copies:

- a)  All    b)  Some\*\*    c)  None of the:
- Certified copies of the priority documents have been received.
  - Certified copies of the priority documents have been received in Application No. \_\_\_\_\_.
  - Copies of the certified copies of the priority documents have been received in this National Stage application from the International Bureau (PCT Rule 17.2(a)).

\*\* See the attached detailed Office action for a list of the certified copies not received.

#### Attachment(s)

- 1)  Notice of References Cited (PTO-892)
- 2)  Information Disclosure Statement(s) (PTO/SB/08a and/or PTO/SB/08b)  
Paper No(s)/Mail Date 5/23/13, 10/24/13, 12/5/13
- 3)  Interview Summary (PTO-413)  
Paper No(s)/Mail Date. \_\_\_\_\_.
- 4)  Other: \_\_\_\_\_.

Art Unit: 2431

1. The present application is being examined under the pre-AIA first to invent provisions.

### **DETAILED ACTION**

2. A request for continued examination under 37 CFR 1.114, including the fee set forth in 37 CFR 1.17(e), was filed in this application after allowance or after an Office action under *Ex Parte Quayle*, 25 USPQ 74, 453 O.G. 213 (Comm'r Pat. 1935). Since this application is eligible for continued examination under 37 CFR 1.114, and the fee set forth in 37 CFR 1.17(e) has been timely paid, prosecution in this application has been reopened pursuant to 37 CFR 1.114. Applicant's submission filed on May 23, 2013 has been entered.

3. Claims 1-15 and 19-20 are pending. Claims 16-18 have been cancelled. Claims 1, 10, and 19-20 have been amended.

### ***Information Disclosure Statements***

4. The Information Disclosure Statements filed on May 23, 2013, October 24, 2013, and December 5, 2013 have been entered and considered.

5. The Non-Patent Literature Documents submitted in the May 23, 2013 Information Disclosure Statement (IDS) appear to have an incorrect date of publication. Document 1 does not include a date of publication. Document 2 was published in 2012. The date of publication has been changed on the IDS.

Art Unit: 2431

***Claim Rejections - 35 USC § 102***

6. The following is a quotation of the appropriate paragraphs of pre-AIA 35 U.S.C. 102 that form the basis for the rejections under this section made in this Office action:

A person shall be entitled to a patent unless –

(e) the invention was described in (1) an application for patent, published under section 122(b), by another filed in the United States before the invention by the applicant for patent or (2) a patent granted on an application for patent by another filed in the United States before the invention by the applicant for patent, except that an international application filed under the treaty defined in section 351(a) shall have the effects for purposes of this subsection of an application filed in the United States only if the international application designated the United States and was published under Article 21(2) of such treaty in the English language.

7. Claims 1-15 and 19-20 are rejected under pre-AIA 35 U.S.C. 102(e) as being anticipated by Grecia (U.S. Patent No. 8,402,555).

(A) As per claim 1, Grecia discloses a method for authorizing a second user to access content stored on a local cloud (A method of providing unlimited interoperability of digital media between unlimited machines with management of end-user access to the digital media; a method for monitoring access to an encrypted digital media, the method facilitating interoperability between a plurality of data processing devices) (col. 3 lines 10-13; col. 14 lines 36-38), comprising:

receiving, at a librarian service operating on a master device (system/ apparatus shown in FIGS. 1-2; cloud system; cloud storage systems such as Amazon's Web Services Simple Storage Solution or also known as S3) (FIGS. 1-2; col. 5 lines 40-45; col. 6 lines 12-17; col. 9 lines 8-15; col. 15 line 49), a request from a first device of a first user to provide a second user with access to content stored on a second device in a local cloud of the first user (receiving an encrypted digital media access branding

Art Unit: 2431

request from a communications console of the plurality of data processing devices, wherein the branding request being a request from one or more secondary users connected to the first user, the one or more secondary users comprising one or more of human beings or programmed computerized mechanisms in network of the first user, wherein the one or more secondary users are validated by a membership web service) (FIG. 6: 602; col. 9 lines 20-23; col. 13 line 65 to col. 14 line 22; col. 14 lines 39-45; col. 15 lines 8-15), the local cloud comprising the first and second devices selected by the first user for inclusion in the local cloud (managing access rights across a plurality of devices; providing unlimited interoperability of digital media between unlimited machines with management of end-user access to the digital media; give users freedom to use products outside of the device in which the product was acquired and extend unlimited interoperability with other compatible devices; Another example is a content provider can allow shared access to friends of the excelsior enabler after a time period, like for example, 90 days. After the 90 day period, when media access is requested using the authentication element by a plurality of secondary enablers, which are usually friends and family of the excelsior enabler, the FBID of the excelsior enabler is cross-referenced with the FBID of the requesting secondary enabler by way of the apparatus ability to execute the Facebook "Friends.areFriends" API command.; receiving an encrypted digital media access branding request from a communications console of the plurality of data processing devices, wherein the branding request being a request from one or more secondary users connected to the first user, the one or more secondary users comprising one or more of human beings or programmed computerized

Art Unit: 2431

mechanisms in network of the first user, wherein the one or more secondary users are validated by a membership web service) (col. 1 lines 24-26; col. 3 lines 10-13; col. 4 lines 6-10; col. 12 lines 10-18; col. 15 lines 8-15);

receiving, at the librarian service from the second device, an indication that the second user is authorized to access the content stored on the second device (The apparatus can ask the potential secondary enabler to participate in communication with the authentication element. The apparatus requires the potential secondary enabler to participate in communication with the authentication element to provide credentials to establish a cross-reference comparison with the FBID retrieved from the metadata and the FBID retrieved from the Facebook "Friends.areFriends" API command to determine if the potential secondary enabler identity is true or false;) (col. 13 line 66 to col. 14 line 10; col. 15 lines 3-18);

determining, at the librarian service, whether the second user is known to the librarian service (determining if the potential secondary enabler identity is true or false, wherein the one or more secondary users are validated by a membership web service, wherein a membership verification token represents verification from content provider to grant access rights to the first user and the one or more secondary users) (col. 14 lines 9-10; col. 15 lines 8-18);

in response to determining that the second user is known, identifying credentials associated with the second user (e.g., MAC address and FBID) (If the comparison action proves to be true, then access rights is granted to the secondary enabler. The current MAC address of the networking card as part of The App and the FBID retrieved

Art Unit: 2431

are appended to the established metadata information the encrypted digital media asset and access rights can be granted to a plurality of secondary enablers.) (col. 14 lines 12-18);

associating the credentials of the second user with the content (If the comparison action proves to be true, then access rights is granted to the secondary enabler. The current MAC address of the networking card as part of The App and the FBID retrieved are appended to the established metadata information the encrypted digital media asset and access rights can be granted to a plurality of secondary enablers.) (col. 14 lines 12-18); and

sending, from the librarian service, an indication to the second user to connect to the local cloud to view the content (FIG. 7 shows a flowchart showing authoring an encrypted digital media. The one or more media items are encrypted to create the encrypted digital media at the step 710.; accessing the digital media as shown in FIG. 5; access rights are granted to a plurality of secondary enablers by the system; unlimited interoperability between devices and “fair use” sharing partners for an infinite time frame; wherein the encrypted digital media is shared with one or more users according to a membership) (col. 8 lines 5-6, lines 31-33, lines 41-42; col. 14 lines 12-22; col. 15 lines 19-21).

(B) As per claim 2, Grecia discloses further comprising:

identifying the first user providing the request (Once an enabler executes an action for access request, the apparatus will obtain the decryption key to first seek the MAC address record. If the MAC address is found, then a cross-reference process is



Art Unit: 2431

executed by comparing the MAC address retrieved from the metadata of the digital media file with the MAC address retrieved from the networking card connected to the apparatus or the App. If the comparison action proves to be true, then access right are granted to the enabler.) (col. 13 lines 45-53); and

determining whether the first user is authorized to grant access to the content (Cross-referencing is used to verify access rights of an enabler or secondary enabler. If the MAC address is found, then a cross-reference process is executed by comparing the MAC address retrieved from the metadata of the digital media file with the MAC address retrieved from the networking card connected to the apparatus or the App. If the comparison action proves to be true, then access rights are granted to the enabler.) (col. 13 lines 45-53; col. 13 line 65 to col. 14 line 18).

(C) As per claim 3, Grecia discloses wherein:

the request comprises identifying information for the second user (secondary enabler provides credentials to establish a cross-reference comparison with the FBID retrieved from the metadata and the FBID retrieved from the Facebook “Friends.areFriends” API command) (col. 14 lines 3-10).

(D) As per claim 4, Grecia discloses wherein the identifying information comprises at least one of:

Art Unit: 2431

an email address (see the login ID in FIG. 3: 307, FIG. 4: 407, and FIG. 5: 509); ;  
and

a telephone number.

(E) As per claim 5, Grecia discloses further comprising:

determining that the second user is a new user; and generating new credentials for the second user (The token represents permission from the content provider to grant access rights to the excelsior enabler and thereafter the plurality of secondary enablers. To set up the verification the content provider can manually or automatically generate a single or a plurality of structured or random password in which will represent the token.) (col. 9 lines 20-25).

(F) As per claim 6, Grecia discloses further comprising:

determining that the second user is known; and retrieving previously generated credentials associated with the second user (If the FBID cross-reference fails, then the apparatus can either ask the potential secondary enabler to participate in communication with the authentication element of the invention, or could deny further interactivity with the potential secondary enabler. In this discussion, the apparatus requires the potential secondary enabler to participate in communication with the authentication element to provide credentials to establish a cross-reference comparison with the FBID retrieved from the metadata and the FBID retrieved from the Facebook "Friends.areFriends" API command to determine if the potential secondary enabler identity is true or false. The determination is in accordance to any possible access

Art Unit: 2431

grace periods set by the content provider of the encrypted digital media asset. If the comparison action proves to be true, then access rights is granted to the secondary enabler and the current MAC address of the networking card as part of The App and the FBID retrieved are appended to the established metadata information of the encrypted digital media asset and access rights can be granted to a plurality of secondary enablers) (col. 13 line 66 to col. 14 line 18).

(G) As per claim 7, Grecia discloses wherein authorizing further comprises:

adding the credentials to an access control list associated with the content (storing a complete list of a plurality of FBIDs to the key file or the metadata thereof; writing information to the digital media metadata, the information including the MAC address, CRC checksum, etc.) (col. 11 line 60 to col. 12 line 9; col. 12 lines 44-55).

(H) As per claim 8, Grecia discloses wherein providing accessing information further comprises:

providing a network address for at least one node of the local cloud (MAC address from a networking card; retrieving the MAC address) (col. 12 lines 44-58; col. 13 line 43 to col. 14 line 22 discusses the process of using MAC addresses).

(I) As per claim 9, Grecia discloses wherein:

Art Unit: 2431

the at least one node operates a service indicating how to access the content (membership service validates secondary users using a membership verification token representing verification from content provider to grant access rights to the first user and one or more secondary users) (col. 15 lines 8-18).

(J) Claims 10-15 and 19-20 repeat the limitations of claims 1-9, and are therefore rejected for the same reasons as those claims, and incorporated herein.

### ***Interview***

8. It is suggested that Applicant's representative contact the Examiner to set up an interview regarding this application.

### ***Conclusion***

9. Any inquiry concerning this communication or earlier communications from the examiner should be directed to CAROLYN B. KOSOWSKI whose telephone number is (571)272-7688. The examiner can normally be reached on Monday through Friday 8:30am-5pm.

If attempts to reach the examiner by telephone are unsuccessful, the examiner's supervisor, Cordelia Zecher can be reached on 571-272-7771. The fax phone number for the organization where this application or proceeding is assigned is 571-273-8300.

Art Unit: 2431

Information regarding the status of an application may be obtained from the Patent Application Information Retrieval (PAIR) system. Status information for published applications may be obtained from either Private PAIR or Public PAIR. Status information for unpublished applications is available through Private PAIR only. For more information about the PAIR system, see <http://pair-direct.uspto.gov>. Should you have questions on access to the Private PAIR system, contact the Electronic Business Center (EBC) at 866-217-9197 (toll-free). If you would like assistance from a USPTO Customer Service Representative or access to the automated information system, call 800-786-9199 (IN USA OR CANADA) or 571-272-1000.

/CAROLYN B KOSOWSKI/  
Primary Examiner, Art Unit 2431

## Electronic Acknowledgement Receipt

<b>EFS ID:</b>	18645357
<b>Application Number:</b>	13740086
<b>International Application Number:</b>	
<b>Confirmation Number:</b>	7081
<b>Title of Invention:</b>	PERSONALIZED DIGITAL MEDIA ACCESS SYSTEM - PDMAS PART II
<b>First Named Inventor/Applicant Name:</b>	William Grecia
<b>Customer Number:</b>	70984
<b>Filer:</b>	William Grecia
<b>Filer Authorized By:</b>	
<b>Attorney Docket Number:</b>	
<b>Receipt Date:</b>	01-APR-2014
<b>Filing Date:</b>	11-JAN-2013
<b>Time Stamp:</b>	19:20:09
<b>Application Type:</b>	Utility under 35 USC 111(a)

### Payment information:

Submitted with Payment	no
------------------------	----

### File Listing:

Document Number	Document Description	File Name	File Size(Bytes)/ Message Digest	Multi Part /.zip	Pages (if appl.)
1	Miscellaneous Incoming Letter	12766337_nfoa.pdf	420834 <small>788864cd0c8cbe42426bfb6b6f4fdca53f77776</small>	no	12

### Warnings:

### Information:

EWS-003684

**This Acknowledgement Receipt evidences receipt on the noted date by the USPTO of the indicated documents, characterized by the applicant, and including page counts, where applicable. It serves as evidence of receipt similar to a Post Card, as described in MPEP 503.**

**New Applications Under 35 U.S.C. 111**

**If a new application is being filed and the application includes the necessary components for a filing date (see 37 CFR 1.53(b)-(d) and MPEP 506), a Filing Receipt (37 CFR 1.54) will be issued in due course and the date shown on this Acknowledgement Receipt will establish the filing date of the application.**

**National Stage of an International Application under 35 U.S.C. 371**

**If a timely submission to enter the national stage of an international application is compliant with the conditions of 35 U.S.C. 371 and other applicable requirements a Form PCT/DO/EO/903 indicating acceptance of the application as a national stage submission under 35 U.S.C. 371 will be issued in addition to the Filing Receipt, in due course.**

**New International Application Filed with the USPTO as a Receiving Office**

**If a new international application is being filed and the international application includes the necessary components for an international filing date (see PCT Article 11 and MPEP 1810), a Notification of the International Application Number and of the International Filing Date (Form PCT/RO/105) will be issued in due course, subject to prescriptions concerning national security, and the date shown on this Acknowledgement Receipt will establish the international filing date of the application.**

<b>TO:</b>  COMMISSIONER OF PATENTS AND TRADEMARKS (USPTO) P.O. Box 1450 Alexandria, VA 22313-1450	<b>REPORT ON THE                  FILING OF DETERMINATION OF AN                  ACTION REGARDING A PATENT OR                  TRADEMARK</b>
---	--

In compliance with 35 U.S.C. 290 and/or 15 U.S.C. 1116 you are hereby advised that a court action has been filed on the following patent(s)/trademark(s) in the U.S. District Court:

DOCKET NO. 1:13-cv-08734	DATE FILED: 12/06/2013	UNITED STATES DISTRICT COURT, NORTHERN DISTRICT OF ILLINOIS, EASTERN DIVISION
Plaintiff(s): William Grecia		Defendant(s): Microsoft Corp.
PATENT NUMBER	DATE OF PATENT	HOLDER OF PATENT
8,533,860 B1	9/10/2013	William Grecia

In the above-entitled case, the following trademarks(s) have been included:

DATE INCLUDED	INCLUDED BY <input type="checkbox"/> Amendment <input type="checkbox"/> Answer <input type="checkbox"/> Cross Bill <input type="checkbox"/> Other Pleading		
TRADEMARK NUMBER	DATE OF TRADEMARK	HOLDER OF PATENT OR TRADEMARK	

In the above-entitled case, the following decision has been rendered or judgment issued:

DECISION/JUDGMENT		
CLERK - Thomas G. Bruton	DEPUTY CLERK: /s/ Esperanza Arnold	DATE: 12/09/2013



AO 121 (6/90)

<b>TO:</b>	
COMMISSIONER OF PATENTS AND TRADEMARKS (USPTO) P.O. Box 1450 Alexandria, VA 22313-1450	<b>REPORT ON THE                  FILING OF DETERMINATION OF AN ACTION OR APPEAL                  REGARDING A COPYRIGHT</b>

In compliance with the Act of July 19, 1952 (66 Stat. 814; 35 U.S.C. 290) you are hereby advised that a court action has been filed on the following patent(s) in the U.S. District Court:

<b>DOCKET</b> 13cv8731	<b>DATE FILED</b> 12/6/13	<b>UNITED STATES DISTRICT COURT, NORTHERN DISTRICT OF ILLINOIS, EASTERN DIVISION</b>
<b>PLAINTIFF</b> William Grecia		<b>DEFENDANT</b> Sony Network Entertainment LLC 12/6/13
<b>PATENT NO.</b>	<b>DATE OF PATENT</b>	<b>PATENTEE</b>
US 8,533,860 B1	9/10/13	William Grecia

In the above-entitled case, the following patent(s) have been included:

<b>DATE INCLUDED</b>	<b>INCLUDED BY</b> <input type="checkbox"/> Amendment <input type="checkbox"/> Answer <input type="checkbox"/> Cross Bill <input type="checkbox"/> Other Pleading		
<b>PATENT NO.</b>	<b>DATE OF PATENT</b>	<b>PATENT</b>	

In the above-entitled case, the following decision has been rendered or judgment issued:

<b>DECISION/JUDGMENT</b>		
<b>CLERK</b> Thomas G. Bruton	<b>(BY) DEPUTY CLERK</b> G. Young	<b>DATE</b> 12/9/13

<b>TO:</b>  COMMISSIONER OF PATENTS AND TRADEMARKS (USPTO) P.O. Box 1450 Alexandria, VA 22313-1450	<b>REPORT ON THE                  FILING OF DETERMINATION OF AN                  ACTION REGARDING A PATENT OR                  TRADEMARK</b>
---	--

In compliance with 35 U.S.C. 290 and/or 15 U.S.C. 1116 you are hereby advised that a court action has been filed on the following patent(s)/trademark(s) in the U.S. District Court:

DOCKET NO. 1:13-cv-08734	DATE FILED: 12/06/2013	UNITED STATES DISTRICT COURT, NORTHERN DISTRICT OF ILLINOIS, EASTERN DIVISION
Plaintiff(s): William Grecia		Defendant(s): Microsoft Corp.
PATENT NUMBER	DATE OF PATENT	HOLDER OF PATENT
8,533,860 B1	9/10/2013	William Grecia

In the above-entitled case, the following trademarks(s) have been included:

DATE INCLUDED	INCLUDED BY <input type="checkbox"/> Amendment <input type="checkbox"/> Answer <input type="checkbox"/> Cross Bill <input type="checkbox"/> Other Pleading		
TRADEMARK NUMBER	DATE OF TRADEMARK	HOLDER OF PATENT OR TRADEMARK	

In the above-entitled case, the following decision has been rendered or judgment issued:

DECISION/JUDGMENT		
CLERK - Thomas G. Bruton	DEPUTY CLERK: /s/ Esperanza Arnold	DATE: 12/09/2013

AO 121 (6/90)

<b>TO:</b>	
COMMISSIONER OF PATENTS AND TRADEMARKS (USPTO) P.O. Box 1450 Alexandria, VA 22313-1450	<b>REPORT ON THE                  FILING OF DETERMINATION OF AN                  ACTION REGARDING A PATENT OR                  TRADEMARK</b>

In compliance with 35 U.S.C. 290 and/or 15 U.S.C. 1116 you are hereby advised that a court action has been filed on the following patent(s)/trademark(s) in the U.S. District Court:

<b>DOCKET NO.</b> 13-cv-08727	<b>DATE FILED:</b> 12/6/2013	<b>UNITED STATES DISTRICT COURT, NORTHERN DISTRICT OF ILLINOIS, EASTERN DIVISION</b>
<b>Plaintiff(s):</b> William Grecia	<b>Defendant(s):</b> Apple Inc.	
<b>PATENT NUMBER</b>	<b>DATE OF PATENT</b>	<b>HOLDER OF PATENT</b>
8,533,860 B1	9/10/13	William Grecia

In the above-entitled case, the following trademarks(s) have been included:

<b>DATE INCLUDED</b>	<b>INCLUDED BY</b> <input type="checkbox"/> Amendment <input type="checkbox"/> Answer <input type="checkbox"/> Cross Bill <input type="checkbox"/> Other Pleading		
<b>TRADEMARK NUMBER</b>	<b>DATE OF TRADEMARK</b>	<b>HOLDER OF PATENT OR TRADEMARK</b>	

In the above-entitled case, the following decision has been rendered or judgment issued:

<b>DECISION/JUDGMENT:</b>		
<b>CLERK - Thomas G. Bruton</b>	<b>DEPUTY CLERK:</b> M. Rivera	<b>DATE:</b> 12/9/13

AO 121 (6/90)

<b>TO:</b>  COMMISSIONER OF PATENTS AND TRADEMARKS (USPTO) P.O. Box 1450 Alexandria, VA 22313-1450	<b>REPORT ON THE                  FILING OF DETERMINATION OF AN ACTION OR APPEAL                  REGARDING A COPYRIGHT</b>
---	---

In compliance with the Act of July 19, 1952 (66 Stat. 814; 35 U.S.C. 290) you are hereby advised that a court action has been filed on the following patent(s) in the U.S. District Court:

<b>DOCKET</b> 13cv8733	<b>DATE FILED</b> 12/6/13	<b>UNITED STATES DISTRICT COURT, NORTHERN DISTRICT OF ILLINOIS, EASTERN DIVISION</b>
<b>PLAINTIFF</b> William Grecia		<b>DEFENDANT</b> Google Inc.
<b>PATENT NO.</b>	<b>DATE OF PATENT</b>	<b>PATENTEE</b>
8,533,860	9/10/13	William Grecia

In the above-entitled case, the following patent(s) have been included:

<b>DATE INCLUDED</b>	<b>INCLUDED BY</b> <input type="checkbox"/> Amendment <input type="checkbox"/> Answer <input type="checkbox"/> Cross Bill <input type="checkbox"/> Other Pleading		
<b>PATENT NO.</b>	<b>DATE OF PATENT</b>	<b>PATENT</b>	

In the above-entitled case, the following decision has been rendered or judgment issued:

DECISION/JUDGMENT		
<b>CLERK</b> Thomas G. Bruton	<b>(BY) DEPUTY CLERK</b> Maya Burke	<b>DATE</b> 12/12/13

AO 121 (6/90)

<b>TO:</b>	
COMMISSIONER OF PATENTS AND TRADEMARKS (USPTO) P.O. Box 1450 Alexandria, VA 22313-1450	<b>REPORT ON THE                  FILING OF DETERMINATION OF AN ACTION OR APPEAL                  REGARDING A COPYRIGHT</b>

In compliance with the Act of July 19, 1952 (66 Stat. 814; 35 U.S.C. 290) you are hereby advised that a court action has been filed on the following patent(s) in the U.S. District Court:

<b>DOCKET</b> 13cv8731	<b>DATE FILED</b> 12/6/13	<b>UNITED STATES DISTRICT COURT, NORTHERN DISTRICT OF ILLINOIS, EASTERN DIVISION</b>
<b>PLAINTIFF</b> William Grecia		<b>DEFENDANT</b> Sony Network Entertainment LLC 12/6/13
<b>PATENT NO.</b> US 8,533,860 B1	<b>DATE OF PATENT</b> 9/10/13	<b>PATENTEE</b> William Grecia

In the above-entitled case, the following patent(s) have been included:

<b>DATE INCLUDED</b>	<b>INCLUDED BY</b> <input type="checkbox"/> Amendment <input type="checkbox"/> Answer <input type="checkbox"/> Cross Bill <input type="checkbox"/> Other Pleading		
<b>PATENT NO.</b>	<b>DATE OF PATENT</b>	<b>PATENT</b>	

In the above-entitled case, the following decision has been rendered or judgment issued:

<b>DECISION/JUDGMENT</b>		
<b>CLERK</b> Thomas G. Bruton	<b>(BY) DEPUTY CLERK</b> G. Young	<b>DATE</b> 12/9/13

UNITED STATES PATENT AND TRADEMARK OFFICE  
**CERTIFICATE OF CORRECTION**

PATENT NO. : 8,533,860 B1  
APPLICATION NO. : 13/740086  
DATED : September 10, 2013  
INVENTOR(S) : William Grecia

Page 1 of 1

It is certified that error appears in the above-identified patent and that said Letters Patent is hereby corrected as shown below:

In the Claims:

In claim 22, column 18, line 37:

“or” should be changed to and read as --and--

Signed and Sealed this  
Seventeenth Day of December, 2013

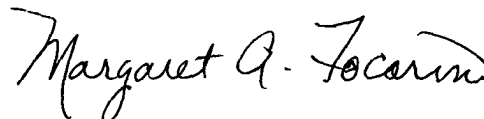

Margaret A. Focarino  
*Commissioner for Patents of the United States Patent and Trademark Office*

EWS-003692

**SPE RESPONSE FOR CERTIFICATE OF CORRECTION**

**DATE** : 11-18-13

**TO SPE OF** : ART UNIT 2494

**SUBJECT** : Request for Certificate of Correction for Appl. No.: 13740086 Patent No.: 8533860

**CofC mailroom date:** 10-13-13

Please respond to this request for a certificate of correction within 7 days.

**FOR IFW FILES:**

Please review the requested changes/corrections as shown in the **COCIN** document(s) in the IFW application image. No new matter should be introduced, nor should the scope or meaning of the claims be changed.

Please complete the response (see below) and forward the completed response to scanning using document code **COCX**.

**FOR PAPER FILES:**

Please review the requested changes/corrections as shown in the attached certificate of correction. Please complete this form (see below) and forward it with the file to:

**Certificates of Correction Branch (CofC)  
Randolph Square – 9D40-E  
Palm Location 7580**

**Note:** \_\_\_\_\_

**Omega Lewis**

**703-756-1575**

**Thank You For Your Assistance**

**The request for issuing the above-identified correction(s) is hereby:**

Note your decision on the appropriate box.

**Approved**

**All changes apply.**

**Approved in Part**

**Specify below which changes **do not** apply.**

**Denied**

**State the reasons for denial below.**

**Comments:** \_\_\_\_\_

\_\_\_\_\_

\_\_\_\_\_

\_\_\_\_\_

/Jung Kim/

2494

**SPE**

**Art Unit**

## **Priority Strings™** *This list was updated on 11/25/2013*

Priority Strings is a system that narrows a USPTO advanced patent application search query down (using only specification keywords) to the associated parent applications of this case, and the earliest patent application filed subsequently by other applicants with similar specification disclosure. This is possible because the specification disclosure of this case precedes in scope to these later filed applications:

**Apple: 12/766,337; 12/846,373; 12/846,363 – USPTO advanced search result shortcut: <http://goo.gl/pFAMik>**  
spec/internet and spec/communications and spec/personal and spec/user and spec/"cloud storage" and spec/component and spec/electronic and spec/network and spec/remote and spec/services and spec/devices and spec/audio and spec/video and spec/"digital media" and spec/bluetooth and spec/first and spec/second and spec/metadata and spec/authentication and spec/automatically and spec/encryption and spec/write and spec/access and spec/authorization and spec/credentials and spec/interface and spec/define and spec/administration

**Google: 13/111,877; 13/248,804 – USPTO shortcut: <http://goo.gl/Y2z0QC>**  
spec/"media products" and spec/api and spec/identity and spec/software and spec/unlicensed

**Microsoft: 13/187,767 - USPTO shortcut: <http://1.usa.gov/1dvsKdx>**  
spec/"operating system" and spec/cloud and spec/unauthorized and spec/content and spec/application and spec/authorization and spec/authentication and spec/id and spec/token and spec/provider and spec/video and spec/"login id" and spec/credentials and spec/"Network Interface" and spec/combination and spec/"providing access" and spec/hosting and spec/identification and spec/decryption and spec/create

**Sony Network Entertainment: 13/312,184 - USPTO shortcut: <http://goo.gl/HziQVg>**  
spec/digital and spec/rights and spec/device and spec/server and spec/identifier and spec/established and spec/protocol and spec/management and spec/relationship and spec/service and spec/provider and spec/user and spec/database and spec/HTTPS and spec/token and spec/encryption and spec/key and spec/associated and spec/private and spec/access and spec/cloud and spec/storage and spec/Windows and spec/AES and spec/image and spec/audio and spec/video and spec/worldwide and spec/interface and spec/client and spec/software and spec/memory and spec/data and spec/communication and spec/valid and spec/authenticated and spec/network and spec/decrypt and spec/"copy protection"

**Sony Pictures: 13/436,567 - USPTO shortcut: <http://goo.gl/LFuMvr>**  
spec/"grant access" and spec/improve and spec/consumer and spec/optical and spec/media and spec/formats and spec/requested and spec/audio and spec/shared and spec/different and spec/levels and spec/personal and spec/cloud and spec/user and spec/entered and spec/relevant and spec/information and spec/building and spec/manage and spec/rights and spec/control and spec/advantages and spec/features and spec/ability and spec/rely and spec/business and spec/entities and spec/content and spec/providers and spec/valid and spec/authorization and spec/agent and spec/granted and spec/"credit card" and spec/hosting and spec/services and spec/phone and spec/number and spec/computer and spec/applications and spec/embedded and spec/"flash memory" and spec/receives and spec/minimum and spec/requests and spec/hardware and spec/electronic and spec/identifier and spec/built and spec/"operating system" and spec/permanent and spec/ROM and spec/length and spec/time and spec/long-term and spec/scenario and spec/disc

**Amazon: 12/889,888; 12/890,314 - USPTO shortcut: <http://goo.gl/Y6g7bl>**  
spec/"cloud computing" and spec/communication and spec/established and spec/connection and spec/console and spec/format and spec/authorization and spec/first and spec/second and spec/user and spec/authenticated and spec/device and spec/proprietary and spec/XML and spec/"media files"



## Electronic Acknowledgement Receipt

<b>EFS ID:</b>	17488210
<b>Application Number:</b>	13740086
<b>International Application Number:</b>	
<b>Confirmation Number:</b>	7081
<b>Title of Invention:</b>	PERSONALIZED DIGITAL MEDIA ACCESS SYSTEM - PDMAS PART II
<b>First Named Inventor/Applicant Name:</b>	William Grecia
<b>Customer Number:</b>	70984
<b>Filer:</b>	William Grecia
<b>Filer Authorized By:</b>	
<b>Attorney Docket Number:</b>	
<b>Receipt Date:</b>	25-NOV-2013
<b>Filing Date:</b>	11-JAN-2013
<b>Time Stamp:</b>	08:01:12
<b>Application Type:</b>	Utility under 35 USC 111(a)

### Payment information:

Submitted with Payment	no
------------------------	----

### File Listing:

Document Number	Document Description	File Name	File Size(Bytes)/ Message Digest	Multi Part /.zip	Pages (if appl.)
1	Miscellaneous Incoming Letter	Priority_StringsII.pdf	377727 <small>1064f4ba38e1ca4fc5crlab78c5e7101ffdd4344a</small>	no	1

### Warnings:

### Information:

EWS-003695

**This Acknowledgement Receipt evidences receipt on the noted date by the USPTO of the indicated documents, characterized by the applicant, and including page counts, where applicable. It serves as evidence of receipt similar to a Post Card, as described in MPEP 503.**

**New Applications Under 35 U.S.C. 111**

**If a new application is being filed and the application includes the necessary components for a filing date (see 37 CFR 1.53(b)-(d) and MPEP 506), a Filing Receipt (37 CFR 1.54) will be issued in due course and the date shown on this Acknowledgement Receipt will establish the filing date of the application.**

**National Stage of an International Application under 35 U.S.C. 371**

**If a timely submission to enter the national stage of an international application is compliant with the conditions of 35 U.S.C. 371 and other applicable requirements a Form PCT/DO/EO/903 indicating acceptance of the application as a national stage submission under 35 U.S.C. 371 will be issued in addition to the Filing Receipt, in due course.**

**New International Application Filed with the USPTO as a Receiving Office**

**If a new international application is being filed and the international application includes the necessary components for an international filing date (see PCT Article 11 and MPEP 1810), a Notification of the International Application Number and of the International Filing Date (Form PCT/RO/105) will be issued in due course, subject to prescriptions concerning national security, and the date shown on this Acknowledgement Receipt will establish the international filing date of the application.**

**SPE RESPONSE FOR CERTIFICATE OF CORRECTION**

**DATE** : 11-18-13

**TO SPE OF** : ART UNIT 2494

**SUBJECT** : Request for Certificate of Correction for Appl. No.: 13740086 Patent No.: 8533860

**CofC mailroom date:** 10-13-13

Please respond to this request for a certificate of correction within 7 days.

**FOR IFW FILES:**

Please review the requested changes/corrections as shown in the **COCIN** document(s) in the IFW application image. No new matter should be introduced, nor should the scope or meaning of the claims be changed.

Please complete the response (see below) and forward the completed response to scanning using document code **COCX**.

**FOR PAPER FILES:**

Please review the requested changes/corrections as shown in the attached certificate of correction. Please complete this form (see below) and forward it with the file to:

**Certificates of Correction Branch (CofC)  
Randolph Square – 9D40-E  
Palm Location 7580**

**Note:** \_\_\_\_\_

**Omega Lewis**

**703-756-1575**

**Thank You For Your Assistance**

**The request for issuing the above-identified correction(s) is hereby:**

Note your decision on the appropriate box.

- |  |   |
|--|---|
| <input type="checkbox"/> <b>Approved</b>         | <b>All changes apply.</b>                               |
| <input type="checkbox"/> <b>Approved in Part</b> | <b>Specify below which changes <b>do not</b> apply.</b> |
| <input type="checkbox"/> <b>Denied</b>           | <b>State the reasons for denial below.</b>              |

**Comments:** \_\_\_\_\_  
\_\_\_\_\_  
\_\_\_\_\_  
\_\_\_\_\_

SPE

EWS-00607

UNITED STATES PATENT AND TRADEMARK OFFICE  
**CERTIFICATE OF CORRECTION**

PATENT NO. : 8,533,860 B1  
APPLICATION NO. : 13/740086  
DATED : September 10, 2013  
INVENTOR(S) : William Grecia

Page 1 of 2

It is certified that error appears in the above-identified patent and that said Letters Patent is hereby corrected as shown below:

On Title page, INSERT:

--(63) Continuation of application No. 13/397,517, filed on Feb. 15, 2012, which is a continuation of application No. 12/985,351, filed on Jan. 6, 2011, which is a continuation of application No. 12/728,218, filed on Mar. 21, 2010, now abandoned.--

In the Claims:

In claim 1, column 15, line 3:

“reference” should be changed to read as --identification reference--

In claim 8, column 15, line 35; and claim 10, column 16, line 31:

“or a membership permission; wherein the at least one of purchase permission, rental permission, or membership permission”,

in each occurrence, should be changed to read as

--and a membership permission; wherein the at least one of purchase permission, rental permission, and membership permission--

In claim 1, column 14, line 56; claim 9, column 16, line 12; claim 11, column 16, line 67; and claim 21, column 18, line 19:

“two way data exchange”, in each occurrence, should be changed to read as --two way data exchange session--

Signed and Sealed this  
Twelfth Day of November, 2013



Teresa Stanek Rea  
Deputy Director of the United States Patent and Trademark Office

EWS-003698

**CERTIFICATE OF CORRECTION (continued)**

**U.S. Pat. No. 8,533,860 B1**

In claim 11, column 16, line 65; and claim 21, column 18, line 16 and 17:

“Applications”, in each occurrence, should be changed to --Application--

In claim 1, column 14, line 55; claim 9, column 16, line 11; claim 11, column 16, line 66; and claim 21, column 18, line 18:

“obtained from”, in each occurrence, should be changed to --related to--

In claim 21, column 17, line 62:

“receiving the digital content access request” should be changed to --receiving a digital content access request--

In claim 21, column 18, line 2:

“handled by the user” should be changed to --handled by a user--

## **Priority Strings™** *This list was compiled on 10/19/2013*

Priority Strings is a system that narrows a USPTO advanced patent application search query down (using only specification keywords) to the associated patent applications of this case, and the earliest patent application filed subsequently by other applicants with similar specification disclosure. This is possible because the specification disclosure of this case precedes in scope to these later filed applications:

### **20110265157 – USPTO advanced search result shortcut: <http://goo.gl/Y9PzqB>**

spec/personal and spec/cloud storage and spec/share and spec/content and spec/stored and spec/network and spec/storage and spec/system and spec/device and spec/associated and spec/first and spec/second and spec/user and spec/determine and spec/identification and spec/protocol and spec/encryption and spec/interface and spec/credentials and spec/grant access and spec/authorization and spec/Bluetooth and spec/software and spec/list and spec/video and spec/audio and spec/e-mail and spec/address and spec/providing and spec/automatically and spec/generated and spec/executed and spec/button

### **20130024919 – USPTO shortcut: <http://goo.gl/rtThG1>**

spec/operating system and spec/cloud and spec/unauthorized and spec/content and spec/application and spec/authorization and spec/authentication and spec/id and spec/token and spec/provider and spec/video and spec/login id and spec/credentials and spec/Network Interface and spec/combo and spec/providing access and spec/hosting and spec/identification and spec/create

### **20130145161 - USPTO shortcut: <http://goo.gl/fXWwXC>**

spec/digital and spec/rights and spec/device and spec/server and spec/identifier and spec/established and spec/protocol and spec/management and spec/relationship and spec/service and spec/provider and spec/user and spec/database and spec/HTTPS and spec/token and spec/encryption and spec/key and spec/associated and spec/private and spec/access and spec/cloud and spec/storage and spec/Windows and spec/AES and spec/image and spec/audio and spec/video and spec/worldwide and spec/interface and spec/client and spec/software and spec/memory and spec/data and spec/communication and spec/valid and spec/authenticated and spec/network and spec/decrypt and spec/copy protection

### **20130262515 - USPTO shortcut: <http://goo.gl/1GZn3l>**

spec/grant access and spec/improve and spec/consumer and spec/optical and spec/media and spec/formats and spec/requested and spec/audio and spec/shared and spec/different and spec/levels and spec/personal and spec/cloud and spec/user and spec/entered and spec/relevant and spec/information and spec/building and spec/manage and spec/rights and spec/control and spec/advantages and spec/features and spec/ability and spec/rely and spec/business and spec/entities and spec/content and spec/providers and spec/valid and spec/authorization and spec/agent and spec/granted and spec/credit card and spec/hosting and spec/services and spec/phone and spec/number and spec/computer and spec/applications and spec/embedded and spec/flash memory and spec/receives and spec/minimum and spec/requests and spec/hardware and spec/electronic and spec/identifier and spec/built and spec/operating system and spec/permanent and spec/ROM and spec/length and spec/time and spec/long-term and spec/scenario

## Validity Strings™ *This list was compiled on 10/19/2013*

Validity Strings are formulas to use with the USPTO advanced patent search engine to isolate this patent using only keywords contained within the patented claims.

aclm/first and aclm/secondary and aclm/identifier and aclm/shared and aclm/connection and aclm/access and aclm/membership

aclm/first and aclm/secondary and aclm/account and aclm/shared and aclm/content and aclm/connection and aclm/membership

aclm/first and aclm/secondary and aclm/account and aclm/shared and aclm/connection and aclm/access and aclm/membership

aclm/device and aclm/cloud and aclm/cpu and aclm/api and aclm/requesting and aclm/receiving and aclm/metadata

aclm/device and aclm/cloud and aclm/access and aclm/cpu and aclm/content and aclm/user and aclm/database

aclm/device and aclm/cloud and aclm/cpu and aclm/api and aclm/content and aclm/access and aclm/metadata

aclm/device and aclm/cloud and aclm/access and aclm/api and aclm/content and aclm/gui and aclm/metadata

aclm/device and aclm/cloud and aclm/access and aclm/api and aclm/content and aclm/cpu and aclm/memory

aclm/cpu and aclm/access and aclm/shared and aclm/membership and aclm/service and aclm/account

aclm/device and aclm/cloud and aclm/access and aclm/cpu and aclm/content and aclm/royalty

aclm/device and aclm/cloud and aclm/connection and aclm/establishing and aclm/rights

aclm/"operating system" and aclm/cloud and aclm/cpu and aclm/memory and aclm/api

aclm/device and aclm/cloud and aclm/connection and aclm/content and aclm/rights

aclm/game and aclm/console and aclm/shared and aclm/cloud and aclm/rights

aclm/device and aclm/cloud and aclm/connection and aclm/cpu and aclm/api

aclm/device and aclm/cloud and aclm/cpu and aclm/memory and aclm/api

aclm/device and aclm/cloud and aclm/content and aclm/cpu and aclm/api

aclm/cloud and aclm/authorization and aclm/device and aclm/automated

aclm/cloud and aclm/shared and aclm/"video game" and aclm/metadata

aclm/game and aclm/console and aclm/shared and aclm/membership

aclm/cloud and aclm/console and aclm/shared and aclm/membership

aclm/cloud and aclm/shared and aclm/"video game" and aclm/product

aclm/establishing and aclm/combination and aclm/api and aclm/gui

aclm/cloud and aclm/access and aclm/membership and aclm/api

aclm/cloud and aclm/connection and aclm/api and aclm/gui

aclm/cloud and aclm/api and aclm/gui and aclm/console

aclm/cloud and aclm/content and aclm/api and aclm/gui  
aclm/"video game" and aclm/cloud and aclm/rights

aclm/shared and aclm/cloud and aclm/permission

aclm/cloud and aclm/rights and aclm/console

aclm/api and aclm/cloud and aclm/rights

aclm/cloud and aclm/rights and aclm/gui

spec/str3em



## Electronic Acknowledgement Receipt

<b>EFS ID:</b>	17174604
<b>Application Number:</b>	13740086
<b>International Application Number:</b>	
<b>Confirmation Number:</b>	7081
<b>Title of Invention:</b>	PERSONALIZED DIGITAL MEDIA ACCESS SYSTEM - PDMAS PART II
<b>First Named Inventor/Applicant Name:</b>	William Grecia
<b>Customer Number:</b>	70984
<b>Filer:</b>	William Grecia
<b>Filer Authorized By:</b>	
<b>Attorney Docket Number:</b>	
<b>Receipt Date:</b>	19-OCT-2013
<b>Filing Date:</b>	11-JAN-2013
<b>Time Stamp:</b>	15:12:25
<b>Application Type:</b>	Utility under 35 USC 111(a)

### Payment information:

Submitted with Payment	no
------------------------	----

### File Listing:

Document Number	Document Description	File Name	File Size(Bytes)/ Message Digest	Multi Part /.zip	Pages (if appl.)
1	Miscellaneous Incoming Letter	Priority_Strings.pdf	497039 <small>e9211be11f972dedca1160d7ed454124d087ee43</small>	no	3

### Warnings:

### Information:

EWS-003703

**This Acknowledgement Receipt evidences receipt on the noted date by the USPTO of the indicated documents, characterized by the applicant, and including page counts, where applicable. It serves as evidence of receipt similar to a Post Card, as described in MPEP 503.**

**New Applications Under 35 U.S.C. 111**

**If a new application is being filed and the application includes the necessary components for a filing date (see 37 CFR 1.53(b)-(d) and MPEP 506), a Filing Receipt (37 CFR 1.54) will be issued in due course and the date shown on this Acknowledgement Receipt will establish the filing date of the application.**

**National Stage of an International Application under 35 U.S.C. 371**

**If a timely submission to enter the national stage of an international application is compliant with the conditions of 35 U.S.C. 371 and other applicable requirements a Form PCT/DO/EO/903 indicating acceptance of the application as a national stage submission under 35 U.S.C. 371 will be issued in addition to the Filing Receipt, in due course.**

**New International Application Filed with the USPTO as a Receiving Office**

**If a new international application is being filed and the international application includes the necessary components for an international filing date (see PCT Article 11 and MPEP 1810), a Notification of the International Application Number and of the International Filing Date (Form PCT/RO/105) will be issued in due course, subject to prescriptions concerning national security, and the date shown on this Acknowledgement Receipt will establish the international filing date of the application.**

**SPE RESPONSE FOR CERTIFICATE OF CORRECTION**

**DATE** : 9-19-13

**TO SPE OF** : ART UNIT 2494

**SUBJECT** : Request for Certificate of Correction for Appl. No.: 13740086 Patent No.: 8533860

**CofC mailroom date:** 9-10-13

Please respond to this request for a certificate of correction within 7 days.

**FOR IFW FILES:**

Please review the requested changes/corrections as shown in the **COCIN** document(s) in the IFW application image. No new matter should be introduced, nor should the scope or meaning of the claims be changed.

Please complete the response (see below) and forward the completed response to scanning using document code **COCX**.

**FOR PAPER FILES:**

Please review the requested changes/corrections as shown in the attached certificate of correction. Please complete this form (see below) and forward it with the file to:

**Certificates of Correction Branch (CofC)  
Randolph Square – 9D40-E  
Palm Location 7580**

**Note:** \_\_\_\_\_

**Omega Lewis**  
**703-756-1575**

**Thank You For Your Assistance**

**The request for issuing the above-identified correction(s) is hereby:**

Note your decision on the appropriate box.

**Approved**

**All changes apply.**

**Approved in Part**

**Specify below which changes do not apply.**

**Denied**

**State the reasons for denial below.**

**Comments:** \_\_\_\_\_ Regarding the request to change the limitation "obtained from" to "related to" in the

Request filed on 9/10/13, this change reflects a mistake of a typographical nature.

\_\_\_\_\_ This change reflects the intended meaning of the claimed invention by both the Office and the Applicant.

\_\_\_\_\_  
/Jung Kim/

\_\_\_\_\_  
AU 2494

**SPE**

**Art Unit**  
EWS-003705

**UNITED STATES PATENT AND TRADEMARK OFFICE  
CERTIFICATE OF CORRECTION**Page 1 of 1

PATENT NO. : 8,533,860  
APPLICATION NO.: 13/740,086  
ISSUE DATE : 09-10-2013  
INVENTOR(S) : William Grecia

It is certified that an error appears or errors appear in the above-identified patent and that said Letters Patent is hereby corrected as shown below:

In claim 22, column 18, line 37:

"or" should be changed to and read as --and--

**MAILING ADDRESS OF SENDER (Please do not use customer number below):**

William Grecia  
2885 Sanford Ave SW #13208  
Grandville, MI 49418

This collection of information is required by 37 CFR 1.322, 1.323, and 1.324. The information is required to obtain or retain a benefit by the public which is to file (and by the USPTO to process) an application. Confidentiality is governed by 35 U.S.C. 122 and 37 CFR 1.14. This collection is estimated to take 1.0 hour to complete, including gathering, preparing, and submitting the completed application form to the USPTO. Time will vary depending upon the individual case. Any comments on the amount of time you require to complete this form and/or suggestions for reducing this burden, should be sent to the Chief Information Officer, U.S. Patent and Trademark Office, U.S. Department of Commerce, P.O. Box 1450, Alexandria, VA 22313-1450. DO NOT SEND FEES OR COMPLETED FORMS TO THIS ADDRESS. **SEND TO: Attention Certificate of Corrections Branch, Commissioner for Patents, P.O. Box 1450, Alexandria, VA 22313-1450.**

*If you need assistance in completing the form, call 1-800-PTO-9199 and select option 2.*

EWS-003706

## Privacy Act Statement

The **Privacy Act of 1974 (P.L. 93-579)** requires that you be given certain information in connection with your submission of the attached form related to a patent application or patent. Accordingly, pursuant to the requirements of the Act, please be advised that: (1) the general authority for the collection of this information is 35 U.S.C. 2(b)(2); (2) furnishing of the information solicited is voluntary; and (3) the principal purpose for which the information is used by the U.S. Patent and Trademark Office is to process and/or examine your submission related to a patent application or patent. If you do not furnish the requested information, the U.S. Patent and Trademark Office may not be able to process and/or examine your submission, which may result in termination of proceedings or abandonment of the application or expiration of the patent.

The information provided by you in this form will be subject to the following routine uses:

1. The information on this form will be treated confidentially to the extent allowed under the Freedom of Information Act (5 U.S.C. 552) and the Privacy Act (5 U.S.C. 552a). Records from this system of records may be disclosed to the Department of Justice to determine whether disclosure of these records is required by the Freedom of Information Act.
2. A record from this system of records may be disclosed, as a routine use, in the course of presenting evidence to a court, magistrate, or administrative tribunal, including disclosures to opposing counsel in the course of settlement negotiations.
3. A record in this system of records may be disclosed, as a routine use, to a Member of Congress submitting a request involving an individual, to whom the record pertains, when the individual has requested assistance from the Member with respect to the subject matter of the record.
4. A record in this system of records may be disclosed, as a routine use, to a contractor of the Agency having need for the information in order to perform a contract. Recipients of information shall be required to comply with the requirements of the Privacy Act of 1974, as amended, pursuant to 5 U.S.C. 552a(m).
5. A record related to an International Application filed under the Patent Cooperation Treaty in this system of records may be disclosed, as a routine use, to the International Bureau of the World Intellectual Property Organization, pursuant to the Patent Cooperation Treaty.
6. A record in this system of records may be disclosed, as a routine use, to another federal agency for purposes of National Security review (35 U.S.C. 181) and for review pursuant to the Atomic Energy Act (42 U.S.C. 218(c)).
7. A record from this system of records may be disclosed, as a routine use, to the Administrator, General Services, or his/her designee, during an inspection of records conducted by GSA as part of that agency's responsibility to recommend improvements in records management practices and programs, under authority of 44 U.S.C. 2904 and 2906. Such disclosure shall be made in accordance with the GSA regulations governing inspection of records for this purpose, and any other relevant (*i.e.*, GSA or Commerce) directive. Such disclosure shall not be used to make determinations about individuals.
8. A record from this system of records may be disclosed, as a routine use, to the public after either publication of the application pursuant to 35 U.S.C. 122(b) or issuance of a patent pursuant to 35 U.S.C. 151. Further, a record may be disclosed, subject to the limitations of 37 CFR 1.14, as a routine use, to the public if the record was filed in an application which became abandoned or in which the proceedings were terminated and which application is referenced by either a published application, an application open to public inspection or an issued patent.
9. A record from this system of records may be disclosed, as a routine use, to a Federal, State, or local law enforcement agency, if the USPTO becomes aware of a violation or potential violation of law or regulation.

## Electronic Patent Application Fee Transmittal

<b>Application Number:</b>	13740086
<b>Filing Date:</b>	11-Jan-2013
<b>Title of Invention:</b>	PERSONALIZED DIGITAL MEDIA ACCESS SYSTEM - PDMAS PART II
<b>First Named Inventor/Applicant Name:</b>	William Grecia
<b>Filer:</b>	William Grecia
<b>Attorney Docket Number:</b>	

Filed as Large Entity

### Utility under 35 USC 111(a) Filing Fees

Description	Fee Code	Quantity	Amount	Sub-Total in USD(\$)
<b>Basic Filing:</b>				
<b>Pages:</b>				
<b>Claims:</b>				
<b>Miscellaneous-Filing:</b>				
<b>Petition:</b>				
<b>Patent-Appeals-and-Interference:</b>				
<b>Post-Allowance-and-Post-Issuance:</b>				
Certificate of Correction	1811	1	100	100

**Extension-of-Time:**

EWS-003708

Description	Fee Code	Quantity	Amount	Sub-Total in USD(\$)
<b>Miscellaneous:</b>				
<b>Total in USD (\$)</b>				<b>100</b>

## Electronic Acknowledgement Receipt

<b>EFS ID:</b>	17113776
<b>Application Number:</b>	13740086
<b>International Application Number:</b>	
<b>Confirmation Number:</b>	7081
<b>Title of Invention:</b>	PERSONALIZED DIGITAL MEDIA ACCESS SYSTEM - PDMAS PART II
<b>First Named Inventor/Applicant Name:</b>	William Grecia
<b>Customer Number:</b>	70984
<b>Filer:</b>	William Grecia
<b>Filer Authorized By:</b>	
<b>Attorney Docket Number:</b>	
<b>Receipt Date:</b>	13-OCT-2013
<b>Filing Date:</b>	11-JAN-2013
<b>Time Stamp:</b>	13:12:04
<b>Application Type:</b>	Utility under 35 USC 111(a)

### Payment information:

Submitted with Payment	yes
Payment Type	Credit Card
Payment was successfully received in RAM	\$100
RAM confirmation Number	8223
Deposit Account	
Authorized User	

### File Listing:

Document Number	Document Description	File Name	File Size(Bytes)/ Message Digest	Multi Part Zip	Pages (if appl.)



1	Request for Certificate of Correction	sb0044-860-and.pdf	164204	no	2
			7d5b34102878d5d6dfa000fcb15d88c2608be95a		

**Warnings:**

**Information:**

2	Fee Worksheet (SB06)	fee-info.pdf	29678	no	2
			b377ac701266a083af4c854b9afdedb1bc7b2e2a		

**Warnings:**

**Information:**

<b>Total Files Size (in bytes):</b>			193882		
-------------------------------------	--	--	--------	--	--

**This Acknowledgement Receipt evidences receipt on the noted date by the USPTO of the indicated documents, characterized by the applicant, and including page counts, where applicable. It serves as evidence of receipt similar to a Post Card, as described in MPEP 503.**

**New Applications Under 35 U.S.C. 111**

**If a new application is being filed and the application includes the necessary components for a filing date (see 37 CFR 1.53(b)-(d) and MPEP 506), a Filing Receipt (37 CFR 1.54) will be issued in due course and the date shown on this Acknowledgement Receipt will establish the filing date of the application.**

**National Stage of an International Application under 35 U.S.C. 371**

**If a timely submission to enter the national stage of an international application is compliant with the conditions of 35 U.S.C. 371 and other applicable requirements a Form PCT/DO/EO/903 indicating acceptance of the application as a national stage submission under 35 U.S.C. 371 will be issued in addition to the Filing Receipt, in due course.**

**New International Application Filed with the USPTO as a Receiving Office**

**If a new international application is being filed and the international application includes the necessary components for an international filing date (see PCT Article 11 and MPEP 1810), a Notification of the International Application Number and of the International Filing Date (Form PCT/RO/105) will be issued in due course, subject to prescriptions concerning national security, and the date shown on this Acknowledgement Receipt will establish the international filing date of the application.**

**SPE RESPONSE FOR CERTIFICATE OF CORRECTION**

**DATE** : 9-19-13

**TO SPE OF** : ART UNIT 2494

**SUBJECT** : Request for Certificate of Correction for Appl. No.: 13740086 Patent No.: 8533860

**CofC mailroom date:** 9-10-13

Please respond to this request for a certificate of correction within 7 days.

**FOR IFW FILES:**

Please review the requested changes/corrections as shown in the **COCIN** document(s) in the IFW application image. No new matter should be introduced, nor should the scope or meaning of the claims be changed.

Please complete the response (see below) and forward the completed response to scanning using document code **COCX**.

**FOR PAPER FILES:**

Please review the requested changes/corrections as shown in the attached certificate of correction. Please complete this form (see below) and forward it with the file to:

**Certificates of Correction Branch (CofC)  
Randolph Square – 9D40-E  
Palm Location 7580**

**Note:** \_\_\_\_\_

**Omega Lewis**

**703-756-1575**

**Thank You For Your Assistance**

**The request for issuing the above-identified correction(s) is hereby:**

Note your decision on the appropriate box.

**Approved**

**All changes apply.**

**Approved in Part**

**Specify below which changes **do not** apply.**

**Denied**

**State the reasons for denial below.**

**Comments:** \_\_\_\_\_

\_\_\_\_\_

\_\_\_\_\_

\_\_\_\_\_

**SPE**

**SH00712**

**UNITED STATES PATENT AND TRADEMARK OFFICE  
CERTIFICATE OF CORRECTION**Page 1 of 1

PATENT NO. : 8,533,860  
APPLICATION NO.: 13/740,086  
ISSUE DATE : 09-10-2013  
INVENTOR(S) : William Grecia

It is certified that an error appears or errors appear in the above-identified patent and that said Letters Patent is hereby corrected as shown below:

In claim 8, column 15, line 35; and claim 10, column 16, line 31:

"or a membership permission; wherein the at least one of purchase permission, rental permission, or membership permission",

in each occurrence, should be changed to and read as

--and a membership permission; wherein the at least one of purchase permission, rental permission, and membership permission--

In claim 1, column 14, line 56; claim 9, column 16, line 12; claim 11, column 16, line 67; and claim 21, column 18, line 19:

"two way data exchange", in each occurrence, should be changed to and read as --two way data exchange session--

**MAILING ADDRESS OF SENDER (Please do not use customer number below):**

William Grecia  
2885 Sanford Ave SW #13208  
Grandville, MI 49418

This collection of information is required by 37 CFR 1.322, 1.323, and 1.324. The information is required to obtain or retain a benefit by the public which is to file (and by the USPTO to process) an application. Confidentiality is governed by 35 U.S.C. 122 and 37 CFR 1.14. This collection is estimated to take 1.0 hour to complete, including gathering, preparing, and submitting the completed application form to the USPTO. Time will vary depending upon the individual case. Any comments on the amount of time you require to complete this form and/or suggestions for reducing this burden, should be sent to the Chief Information Officer, U.S. Patent and Trademark Office, U.S. Department of Commerce, P.O. Box 1450, Alexandria, VA 22313-1450. DO NOT SEND FEES OR COMPLETED FORMS TO THIS ADDRESS. **SEND TO: Attention Certificate of Corrections Branch, Commissioner for Patents, P.O. Box 1450, Alexandria, VA 22313-1450.**

*If you need assistance in completing the form, call 1-800-PTO-9199 and select option 2.*

EWS-003713

## Privacy Act Statement

The **Privacy Act of 1974 (P.L. 93-579)** requires that you be given certain information in connection with your submission of the attached form related to a patent application or patent. Accordingly, pursuant to the requirements of the Act, please be advised that: (1) the general authority for the collection of this information is 35 U.S.C. 2(b)(2); (2) furnishing of the information solicited is voluntary; and (3) the principal purpose for which the information is used by the U.S. Patent and Trademark Office is to process and/or examine your submission related to a patent application or patent. If you do not furnish the requested information, the U.S. Patent and Trademark Office may not be able to process and/or examine your submission, which may result in termination of proceedings or abandonment of the application or expiration of the patent.

The information provided by you in this form will be subject to the following routine uses:

1. The information on this form will be treated confidentially to the extent allowed under the Freedom of Information Act (5 U.S.C. 552) and the Privacy Act (5 U.S.C. 552a). Records from this system of records may be disclosed to the Department of Justice to determine whether disclosure of these records is required by the Freedom of Information Act.
2. A record from this system of records may be disclosed, as a routine use, in the course of presenting evidence to a court, magistrate, or administrative tribunal, including disclosures to opposing counsel in the course of settlement negotiations.
3. A record in this system of records may be disclosed, as a routine use, to a Member of Congress submitting a request involving an individual, to whom the record pertains, when the individual has requested assistance from the Member with respect to the subject matter of the record.
4. A record in this system of records may be disclosed, as a routine use, to a contractor of the Agency having need for the information in order to perform a contract. Recipients of information shall be required to comply with the requirements of the Privacy Act of 1974, as amended, pursuant to 5 U.S.C. 552a(m).
5. A record related to an International Application filed under the Patent Cooperation Treaty in this system of records may be disclosed, as a routine use, to the International Bureau of the World Intellectual Property Organization, pursuant to the Patent Cooperation Treaty.
6. A record in this system of records may be disclosed, as a routine use, to another federal agency for purposes of National Security review (35 U.S.C. 181) and for review pursuant to the Atomic Energy Act (42 U.S.C. 218(c)).
7. A record from this system of records may be disclosed, as a routine use, to the Administrator, General Services, or his/her designee, during an inspection of records conducted by GSA as part of that agency's responsibility to recommend improvements in records management practices and programs, under authority of 44 U.S.C. 2904 and 2906. Such disclosure shall be made in accordance with the GSA regulations governing inspection of records for this purpose, and any other relevant (*i.e.*, GSA or Commerce) directive. Such disclosure shall not be used to make determinations about individuals.
8. A record from this system of records may be disclosed, as a routine use, to the public after either publication of the application pursuant to 35 U.S.C. 122(b) or issuance of a patent pursuant to 35 U.S.C. 151. Further, a record may be disclosed, subject to the limitations of 37 CFR 1.14, as a routine use, to the public if the record was filed in an application which became abandoned or in which the proceedings were terminated and which application is referenced by either a published application, an application open to public inspection or an issued patent.
9. A record from this system of records may be disclosed, as a routine use, to a Federal, State, or local law enforcement agency, if the USPTO becomes aware of a violation or potential violation of law or regulation.

IN THE UNITED STATES PATENT AND TRADEMARK OFFICE

William Grecia  
Patent No.: 8,533,860  
Issued: September 10, 2013

Examiner: Tran, Tri

Art Unit: 2494

**COCR**

Assistant Commissioner for Patents  
P. O. Box 1450  
Alexandria VA, 22313-1450

**Request for Certificate of Correction under 37 C.F.R. § 1.323**

This paper requests a third Certificate of Correction, the second under 37 C.F.R. § 1.323 for the United States patent identified above. Accompanying this request is a Certificate of Correction form PTO/SB/44 containing the text of this correction. Applicant submits the fee due to corrections being:

- (1) of a clerical nature,
- (2) of a typographical nature, or
- (3) a mistake of minor character.

This request does not involve changes that would:

- (1) constitute new matter or
- (2) require reexamination

Respectfully,  
/william grecia/  
William Grecia  
Applicant Pro Se

## Electronic Patent Application Fee Transmittal

<b>Application Number:</b>	13740086
<b>Filing Date:</b>	11-Jan-2013
<b>Title of Invention:</b>	PERSONALIZED DIGITAL MEDIA ACCESS SYSTEM - PDMAS PART II
<b>First Named Inventor/Applicant Name:</b>	William Grecia
<b>Filer:</b>	William Grecia
<b>Attorney Docket Number:</b>	

Filed as Large Entity

### Utility under 35 USC 111(a) Filing Fees

Description	Fee Code	Quantity	Amount	Sub-Total in USD(\$)
<b>Basic Filing:</b>				
<b>Pages:</b>				
<b>Claims:</b>				
<b>Miscellaneous-Filing:</b>				
<b>Petition:</b>				
<b>Patent-Appeals-and-Interference:</b>				
<b>Post-Allowance-and-Post-Issuance:</b>				
Certificate of Correction	1811	1	100	100

**Extension-of-Time:**

EWS-003716

Description	Fee Code	Quantity	Amount	Sub-Total in USD(\$)
<b>Miscellaneous:</b>				
<b>Total in USD (\$)</b>				<b>100</b>

## Electronic Acknowledgement Receipt

<b>EFS ID:</b>	16858073
<b>Application Number:</b>	13740086
<b>International Application Number:</b>	
<b>Confirmation Number:</b>	7081
<b>Title of Invention:</b>	PERSONALIZED DIGITAL MEDIA ACCESS SYSTEM - PDMAS PART II
<b>First Named Inventor/Applicant Name:</b>	William Grecia
<b>Customer Number:</b>	70984
<b>Filer:</b>	William Grecia
<b>Filer Authorized By:</b>	
<b>Attorney Docket Number:</b>	
<b>Receipt Date:</b>	16-SEP-2013
<b>Filing Date:</b>	11-JAN-2013
<b>Time Stamp:</b>	10:57:26
<b>Application Type:</b>	Utility under 35 USC 111(a)

### Payment information:

Submitted with Payment	yes
Payment Type	Credit Card
Payment was successfully received in RAM	\$100
RAM confirmation Number	9792
Deposit Account	
Authorized User	

### File Listing:

Document Number	Document Description	File Name	File Size(Bytes)/ Message Digest	Multi Part Zip	Pages (if appl.)
-----------------	----------------------	-----------	-------------------------------------	-------------------	---------------------



1	Request for Certificate of Correction	sb0044-860patent-c2.pdf	164684 4fdb31d792c319f8819f5b4bac7e61ad903a ec5f	no	2
<b>Warnings:</b>					
<b>Information:</b>					
2	Request for Certificate of Correction	860COC3.pdf	106963 9d6137b1f39a2529c2b60d98708dfdc3ec1f 2011	no	1
<b>Warnings:</b>					
<b>Information:</b>					
3	Fee Worksheet (SB06)	fee-info.pdf	29678 a7b1b74c000fc03b663caac8465c56006333 7d1f	no	2
<b>Warnings:</b>					
<b>Information:</b>					
<b>Total Files Size (in bytes):</b>			301325		

**This Acknowledgement Receipt evidences receipt on the noted date by the USPTO of the indicated documents, characterized by the applicant, and including page counts, where applicable. It serves as evidence of receipt similar to a Post Card, as described in MPEP 503.**

**New Applications Under 35 U.S.C. 111**

**If a new application is being filed and the application includes the necessary components for a filing date (see 37 CFR 1.53(b)-(d) and MPEP 506), a Filing Receipt (37 CFR 1.54) will be issued in due course and the date shown on this Acknowledgement Receipt will establish the filing date of the application.**

**National Stage of an International Application under 35 U.S.C. 371**

**If a timely submission to enter the national stage of an international application is compliant with the conditions of 35 U.S.C. 371 and other applicable requirements a Form PCT/DO/EO/903 indicating acceptance of the application as a national stage submission under 35 U.S.C. 371 will be issued in addition to the Filing Receipt, in due course.**

**New International Application Filed with the USPTO as a Receiving Office**

**If a new international application is being filed and the international application includes the necessary components for an international filing date (see PCT Article 11 and MPEP 1810), a Notification of the International Application Number and of the International Filing Date (Form PCT/RO/105) will be issued in due course, subject to prescriptions concerning national security, and the date shown on this Acknowledgement Receipt will establish the international filing date of the application.**

**UNITED STATES PATENT AND TRADEMARK OFFICE  
CERTIFICATE OF CORRECTION**Page 1 of 1

PATENT NO. : 8,533,860  
APPLICATION NO.: 13/740,086  
ISSUE DATE : 09-10-2013  
INVENTOR(S) : William Grecia

It is certified that an error appears or errors appear in the above-identified patent and that said Letters Patent is hereby corrected as shown below:

In claim 1, column 15, line 3:

"reference" should be changed to and read as --identification reference--

In cover page, INSERT:

-- (63) Continuation of application No. 13/397,517, filed on Feb. 15, 2012, which is a continuation of application No. 12/985,351, filed on Jan. 6, 2011, which is a continuation of application No. 12/728,218, filed on Mar. 21, 2010, now abandoned. --

**MAILING ADDRESS OF SENDER (Please do not use customer number below):**

William Grecia  
2885 Sanford Ave SW #13208  
Grandville, MI 49418

This collection of information is required by 37 CFR 1.322, 1.323, and 1.324. The information is required to obtain or retain a benefit by the public which is to file (and by the USPTO to process) an application. Confidentiality is governed by 35 U.S.C. 122 and 37 CFR 1.14. This collection is estimated to take 1.0 hour to complete, including gathering, preparing, and submitting the completed application form to the USPTO. Time will vary depending upon the individual case. Any comments on the amount of time you require to complete this form and/or suggestions for reducing this burden, should be sent to the Chief Information Officer, U.S. Patent and Trademark Office, U.S. Department of Commerce, P.O. Box 1450, Alexandria, VA 22313-1450. DO NOT SEND FEES OR COMPLETED FORMS TO THIS ADDRESS. **SEND TO: Attention Certificate of Corrections Branch, Commissioner for Patents, P.O. Box 1450, Alexandria, VA 22313-1450.**

*If you need assistance in completing the form, call 1-800-PTO-9199 and select option 2.*

EWS-003720

## Privacy Act Statement

The **Privacy Act of 1974 (P.L. 93-579)** requires that you be given certain information in connection with your submission of the attached form related to a patent application or patent. Accordingly, pursuant to the requirements of the Act, please be advised that: (1) the general authority for the collection of this information is 35 U.S.C. 2(b)(2); (2) furnishing of the information solicited is voluntary; and (3) the principal purpose for which the information is used by the U.S. Patent and Trademark Office is to process and/or examine your submission related to a patent application or patent. If you do not furnish the requested information, the U.S. Patent and Trademark Office may not be able to process and/or examine your submission, which may result in termination of proceedings or abandonment of the application or expiration of the patent.

The information provided by you in this form will be subject to the following routine uses:

1. The information on this form will be treated confidentially to the extent allowed under the Freedom of Information Act (5 U.S.C. 552) and the Privacy Act (5 U.S.C. 552a). Records from this system of records may be disclosed to the Department of Justice to determine whether disclosure of these records is required by the Freedom of Information Act.
2. A record from this system of records may be disclosed, as a routine use, in the course of presenting evidence to a court, magistrate, or administrative tribunal, including disclosures to opposing counsel in the course of settlement negotiations.
3. A record in this system of records may be disclosed, as a routine use, to a Member of Congress submitting a request involving an individual, to whom the record pertains, when the individual has requested assistance from the Member with respect to the subject matter of the record.
4. A record in this system of records may be disclosed, as a routine use, to a contractor of the Agency having need for the information in order to perform a contract. Recipients of information shall be required to comply with the requirements of the Privacy Act of 1974, as amended, pursuant to 5 U.S.C. 552a(m).
5. A record related to an International Application filed under the Patent Cooperation Treaty in this system of records may be disclosed, as a routine use, to the International Bureau of the World Intellectual Property Organization, pursuant to the Patent Cooperation Treaty.
6. A record in this system of records may be disclosed, as a routine use, to another federal agency for purposes of National Security review (35 U.S.C. 181) and for review pursuant to the Atomic Energy Act (42 U.S.C. 218(c)).
7. A record from this system of records may be disclosed, as a routine use, to the Administrator, General Services, or his/her designee, during an inspection of records conducted by GSA as part of that agency's responsibility to recommend improvements in records management practices and programs, under authority of 44 U.S.C. 2904 and 2906. Such disclosure shall be made in accordance with the GSA regulations governing inspection of records for this purpose, and any other relevant (*i.e.*, GSA or Commerce) directive. Such disclosure shall not be used to make determinations about individuals.
8. A record from this system of records may be disclosed, as a routine use, to the public after either publication of the application pursuant to 35 U.S.C. 122(b) or issuance of a patent pursuant to 35 U.S.C. 151. Further, a record may be disclosed, subject to the limitations of 37 CFR 1.14, as a routine use, to the public if the record was filed in an application which became abandoned or in which the proceedings were terminated and which application is referenced by either a published application, an application open to public inspection or an issued patent.
9. A record from this system of records may be disclosed, as a routine use, to a Federal, State, or local law enforcement agency, if the USPTO becomes aware of a violation or potential violation of law or regulation.

IN THE UNITED STATES PATENT AND TRADEMARK OFFICE

William Grecia  
Patent No.: 8,533,860  
Issued: September 10, 2013

Examiner: Tran, Tri  
Art Unit: 2494  
CNF# 7081  
**COCR**

Assistant Commissioner for Patents  
P. O. Box 1450  
Alexandria VA, 22313-1450

**Request for Certificate of Correction under 37 C.F.R. § 1.322**

This paper requests a second Certificate of Correction, the first under 37 C.F.R. § 1.322 for the United States patent identified above. This correction request is due to USPTO mistakes made during publication of the patent. Evidence to support this request:

- 1) Copy of claim 1 as entered in an Examiner's amendment made in document code N271 Response to Amendment under Rule 312, Mail Room Date 08-05-2013.
- 2) Copy of column 1 between lines 1 and 15 of the above identified patent publication containing Cross Reference To Related Applications information.

Accompanying this request is a Certificate of Correction form PTO/SB/44 containing the text of this correction. No fee is rendered for this request due to the mistakes not originating from the Applicant.

Respectfully,  
/william grecia/  
William Grecia  
Applicant Pro Se

NOTE

Below are the corrected Amendments that are based on the claims amended by the Examiner in the Notice of Allowance mailed on May 31, 2013. Note that the proposed amendments submitted by the Applicant under Rule 312 also filed on the same day of May 31 2013 include changes already addressed in the examiner's amendment in the aforementioned Notice of Allowance.

Claim Amendments

1. (Currently amended) *A method for authorizing access to digital content using a cloud system, the cloud system comprising connected modules in operation as one or more of a cloud computing or a cloud storage in connection with devices and users, wherein the digital content ~~being~~is at least one of encrypted or not encrypted, the method facilitating access rights between a plurality of data processing devices, the method comprising:*

*receiving ~~[[the]]~~a digital content access request from at least one communications console of the plurality of data processing devices, the access request being a read or write request of metadata of the digital content, wherein the read or write request of metadata is performed in connection with a combination of at least one device and the cloud system, the request comprising a verification token provided by a first user corresponding to the digital content, wherein the verification token is one or more of a password, e-mail address, payment system, credit card, authorize ready device, rights token, or one or more redeemable instruments of trade;*

*authenticating the verification token;*

Art Unit: 2494

*establishing a connection with the at least one communications console, wherein the communications console is a combination of a graphic user interface (GUI) and an Application[[s]] Programmable Interface (API) wherein the API is obtained from a verified web service, the web service capable of facilitating a two way data exchange to complete a verification process wherein the data exchange session comprises at least one identification reference;*

*requesting the at least one identification reference from the at least one communications console, wherein the identification reference comprises one or more of a verified web service account identifier, letter, number, rights token, e-mail, password, access time, serial number, address, manufacturer identification, checksum, operating system version, browser version, credential, cookie, or key;*

*receiving the at least one identification reference from the at least one communications console; and*

*writing at least one of the verification token or the identification reference into the metadata.*

*2. (Currently amended) The method according to claim 1, wherein the access request being a request from the first user through a data processing device of the plurality of data processing devices; or*

*wherein the access request being a request from one or more secondary users in network to the first user;*

*wherein [[said]]the secondary users are validated by a membership web service.*

**PERSONALIZED DIGITAL MEDIA ACCESS  
SYSTEM—PDMAS PART II**

CROSS-REFERENCE TO RELATED  
APPLICATIONS

This application is a continuation of and claims the priority benefit of U.S. patent application Ser. No. 13/397,517 filed Feb. 15, 2012, now pending, which is a continuation of Ser. No. 12/985,351 filed Jan. 6, 2011, now abandoned, which is a continuation of Ser. No. 12/728,218 filed Mar. 21, 2010, now abandoned. Each patent application identified above is incorporated here by reference in its entirety to provide continuity of disclosure.

BACKGROUND OF THE INVENTION

1. Field of the Invention

The present invention relates to the field of digital rights management schemes used by creators of electronic products to protect commercial intellectual property copyrights privy to illegal copying using computerized devices. More specifically, the present invention teaches a more personal system of digital rights management which employs electronic ID, as part of a web service membership, to manage access rights across a plurality of devices.

2. Description of the Prior Art

Digital rights management (DRM) is a generic term for access control technologies used by hardware manufacturers, publishers, copyright holders and individuals to impose limitations on the usage of digital content across devices. DRM refers to any technology that inhibits undesirable or illegal uses of the digital content. The term generally doesn't refer to forms of copy protection that can be circumvented without modifying the file or device, such as serial numbers or key files. It can also refer to restrictions associated with specific instances of digital works or devices.

Traditional DRM schemes are defined as authentication components added to digital files that have been encrypted from public access. Encryption schemes are not DRM methods but DRM systems are implemented to use an additional layer of authentication in which permission is granted for access to the cipher key required to decrypt files for access. A computer server is established to host decryption keys and to accept authentication keys from Internet connected client computers running client software in which handles the encrypted files. The server can administer different authorization keys back to the client computer that can grant different sets of rules and a time frame granted before the client is required to connect with the server to reauthorize access permissions. In some cases content can terminate access after a set amount of time, or the process can break if the provider of the DRM server ever ceases to offer services.

In the present scenario, consumer entertainment industries are in the transition of delivering products on physical media such as CD and DVD to Internet delivered systems. The Compact Disc, introduced to the public in 1982, was initially designed as a proprietary system offering strict media to player compatibility. As the popularity of home computers and CD-ROM drives rose, so did the availability of CD ripping applications to make local copies of music to be enjoyed without the use of the disc. After a while, users found ways to share digital versions of music in the form of MP3 files that could be easily shared with family and friends over the Internet. The DVD format introduced in 1997 included a new apparatus for optical discs technology with embedded copy protection schemes also recognized as an early form of DRM.

With internet delivered music and video files, DRM schemes has been developed to lock acquired media to specific machines and most times limiting playback rights to a single machine or among a limited number of multiple machines regardless of the model number. This was achieved by writing the machine device ID to the metadata of the media file, then cross referencing with a trusted clearinghouse according to pre-set rules. DRM systems employed by DVD and CD technologies consisted of scrambling (also known as encryption) disc sectors in a pattern to which hardware developed to unscramble (also known as decryption) the disc sectors are required for playback. DRM systems built into operating systems such as Microsoft Windows Vista block viewing of media when an unsigned software application is running to prevent unauthorized copying of a media asset during playback. DRM used in computer games such as SecuROM and Steam are used to limit the amount of times a user can install a game on a machine. DRM schemes for e-books include embedding credit card information and other personal information inside the metadata area of a delivered file format and restricting the compatibility of the file with a limited number of reader devices and computer applications.

In a typical DRM system, a product is encrypted using Symmetric block ciphers such as DES and AES to provide high levels of security. Ciphers known as asymmetric or public key/private key systems are used to manage access to encrypted products. In asymmetric systems the key used to encrypt a product is not the same as that used to decrypt it. If a product has been encrypted using one key of a pair it cannot be decrypted even by someone else who has that key. Only the matching key of the pair can be used for decryption. After receiving an authorization token from a first-use action are usually triggers to decrypt block ciphers in most DRM systems. User rights and restrictions are established during this first-use action with the corresponding hosting device of a DRM protected product.

Examples of such prior DRM art include Hurtado (U.S. Pat. No. 6,611,812) who described a digital rights management system, where upon request to access digital content, encryption and decryption keys are exchanged and managed via an authenticity clearing house. Other examples include Alve (U.S. Pat. No. 7,568,111) who teaches a DRM and Tuoriniemi (U.S. Pat. No. 20090164776) who described a management scheme to control access to electronic content by recording use across a plurality of trustworthy devices that has been granted permission to work within the scheme.

Recently, DRM schemes have proven unpopular with consumers and rights organizations that oppose the complications with compatibility across machines manufactured by different companies. Reasons given to DRM opposition range from limited device playback restrictions to the loss of fair-use which defines the freedom to share media products will family members.

Prior art DRM methods rely on content providers to maintain computer servers to receive and send session authorization keys to client computers with an Internet connection. Usually rights are given from the server for an amount of time or amount of access actions before a requirement to reconnect with the server is required for reauthorization. At times, content providers will discontinue servers or even go out of business some years after DRM encrypted content was sold to consumers causing the ability to access files to terminate.

In the light of the foregoing discussion, the current states of DRM measures are not satisfactory because unavoidable issues can arise such as hardware failure or property theft that could lead to a paying customer loosing the right to recover purchased products. The current metadata writable DRM

## Electronic Acknowledgement Receipt

<b>EFS ID:</b>	16844971
<b>Application Number:</b>	13740086
<b>International Application Number:</b>	
<b>Confirmation Number:</b>	7081
<b>Title of Invention:</b>	PERSONALIZED DIGITAL MEDIA ACCESS SYSTEM - PDMAS PART II
<b>First Named Inventor/Applicant Name:</b>	William Grecia
<b>Customer Number:</b>	70984
<b>Filer:</b>	William Grecia
<b>Filer Authorized By:</b>	
<b>Attorney Docket Number:</b>	
<b>Receipt Date:</b>	13-SEP-2013
<b>Filing Date:</b>	11-JAN-2013
<b>Time Stamp:</b>	11:05:14
<b>Application Type:</b>	Utility under 35 USC 111(a)

### Payment information:

Submitted with Payment	no
------------------------	----

### File Listing:

Document Number	Document Description	File Name	File Size(Bytes)/ Message Digest	Multi Part /.zip	Pages (if appl.)
1	Request for Certificate of Correction	sb0044-860-om.pdf	164637 <small>d882415dc4870d9b9dddf3c44e7f9df12fbf92db3</small>	no	2

### Warnings:

### Information:

EWS-003726



2	Request for Certificate of Correction	COC3a.pdf	430380 6cd3445aff0d2740aba6b97c35f11a55a9b9bae	no	4
---	---------------------------------------	-----------	---	----	---

**Warnings:**

**Information:**

<b>Total Files Size (in bytes):</b>	595017
-------------------------------------	--------

**This Acknowledgement Receipt evidences receipt on the noted date by the USPTO of the indicated documents, characterized by the applicant, and including page counts, where applicable. It serves as evidence of receipt similar to a Post Card, as described in MPEP 503.**

**New Applications Under 35 U.S.C. 111**

**If a new application is being filed and the application includes the necessary components for a filing date (see 37 CFR 1.53(b)-(d) and MPEP 506), a Filing Receipt (37 CFR 1.54) will be issued in due course and the date shown on this Acknowledgement Receipt will establish the filing date of the application.**

**National Stage of an International Application under 35 U.S.C. 371**

**If a timely submission to enter the national stage of an international application is compliant with the conditions of 35 U.S.C. 371 and other applicable requirements a Form PCT/DO/EO/903 indicating acceptance of the application as a national stage submission under 35 U.S.C. 371 will be issued in addition to the Filing Receipt, in due course.**

**New International Application Filed with the USPTO as a Receiving Office**

**If a new international application is being filed and the international application includes the necessary components for an international filing date (see PCT Article 11 and MPEP 1810), a Notification of the International Application Number and of the International Filing Date (Form PCT/RO/105) will be issued in due course, subject to prescriptions concerning national security, and the date shown on this Acknowledgement Receipt will establish the international filing date of the application.**

**UNITED STATES PATENT AND TRADEMARK OFFICE  
CERTIFICATE OF CORRECTION**Page 1 of 1

PATENT NO. : 8,533,860  
APPLICATION NO.: 13/740,086  
ISSUE DATE : 09-10-2013  
INVENTOR(S) : William Grecia

It is certified that an error appears or errors appear in the above-identified patent and that said Letters Patent is hereby corrected as shown below:

In claim 11, column 16, line 65; and claim 21, column 18, line 16 and 17:

"Applications", in each occurrence, should be changed to --Application--

In claim 1, column 14, line 55; claim 9, column 16, line 11; claim 11, column 16, line 66; and claim 21, column 18, line 18:

"obtained from", in each occurrence, should be changed to --related to--

In claim 21, column 17, line 62:

"receiving the digital content access request" should be changed to --receiving a digital content access request--

In claim 21, column 18, line 2:

"handled by the user" should be changed to --handled by a user--

**MAILING ADDRESS OF SENDER (Please do not use customer number below):**

William Grecia  
2885 Sanford Ave SW #13208  
Grandville, MI 49418

This collection of information is required by 37 CFR 1.322, 1.323, and 1.324. The information is required to obtain or retain a benefit by the public which is to file (and by the USPTO to process) an application. Confidentiality is governed by 35 U.S.C. 122 and 37 CFR 1.14. This collection is estimated to take 1.0 hour to complete, including gathering, preparing, and submitting the completed application form to the USPTO. Time will vary depending upon the individual case. Any comments on the amount of time you require to complete this form and/or suggestions for reducing this burden, should be sent to the Chief Information Officer, U.S. Patent and Trademark Office, U.S. Department of Commerce, P.O. Box 1450, Alexandria, VA 22313-1450. DO NOT SEND FEES OR COMPLETED FORMS TO THIS ADDRESS. **SEND TO: Attention Certificate of Corrections Branch, Commissioner for Patents, P.O. Box 1450, Alexandria, VA 22313-1450.**

*If you need assistance in completing the form, call 1-800-PTO-9199 and select option 2.*

EWS-003728

## Privacy Act Statement

The **Privacy Act of 1974 (P.L. 93-579)** requires that you be given certain information in connection with your submission of the attached form related to a patent application or patent. Accordingly, pursuant to the requirements of the Act, please be advised that: (1) the general authority for the collection of this information is 35 U.S.C. 2(b)(2); (2) furnishing of the information solicited is voluntary; and (3) the principal purpose for which the information is used by the U.S. Patent and Trademark Office is to process and/or examine your submission related to a patent application or patent. If you do not furnish the requested information, the U.S. Patent and Trademark Office may not be able to process and/or examine your submission, which may result in termination of proceedings or abandonment of the application or expiration of the patent.

The information provided by you in this form will be subject to the following routine uses:

1. The information on this form will be treated confidentially to the extent allowed under the Freedom of Information Act (5 U.S.C. 552) and the Privacy Act (5 U.S.C. 552a). Records from this system of records may be disclosed to the Department of Justice to determine whether disclosure of these records is required by the Freedom of Information Act.
2. A record from this system of records may be disclosed, as a routine use, in the course of presenting evidence to a court, magistrate, or administrative tribunal, including disclosures to opposing counsel in the course of settlement negotiations.
3. A record in this system of records may be disclosed, as a routine use, to a Member of Congress submitting a request involving an individual, to whom the record pertains, when the individual has requested assistance from the Member with respect to the subject matter of the record.
4. A record in this system of records may be disclosed, as a routine use, to a contractor of the Agency having need for the information in order to perform a contract. Recipients of information shall be required to comply with the requirements of the Privacy Act of 1974, as amended, pursuant to 5 U.S.C. 552a(m).
5. A record related to an International Application filed under the Patent Cooperation Treaty in this system of records may be disclosed, as a routine use, to the International Bureau of the World Intellectual Property Organization, pursuant to the Patent Cooperation Treaty.
6. A record in this system of records may be disclosed, as a routine use, to another federal agency for purposes of National Security review (35 U.S.C. 181) and for review pursuant to the Atomic Energy Act (42 U.S.C. 218(c)).
7. A record from this system of records may be disclosed, as a routine use, to the Administrator, General Services, or his/her designee, during an inspection of records conducted by GSA as part of that agency's responsibility to recommend improvements in records management practices and programs, under authority of 44 U.S.C. 2904 and 2906. Such disclosure shall be made in accordance with the GSA regulations governing inspection of records for this purpose, and any other relevant (*i.e.*, GSA or Commerce) directive. Such disclosure shall not be used to make determinations about individuals.
8. A record from this system of records may be disclosed, as a routine use, to the public after either publication of the application pursuant to 35 U.S.C. 122(b) or issuance of a patent pursuant to 35 U.S.C. 151. Further, a record may be disclosed, subject to the limitations of 37 CFR 1.14, as a routine use, to the public if the record was filed in an application which became abandoned or in which the proceedings were terminated and which application is referenced by either a published application, an application open to public inspection or an issued patent.
9. A record from this system of records may be disclosed, as a routine use, to a Federal, State, or local law enforcement agency, if the USPTO becomes aware of a violation or potential violation of law or regulation.

IN THE UNITED STATES PATENT AND TRADEMARK OFFICE

William Grecia  
Patent No.: 8,533,860  
Issued: September 10, 2013

Examiner: Tran, Tri  
Art Unit: 2494  
CNF# 7081  
**COCR**

Assistant Commissioner for Patents  
P. O. Box 1450  
Alexandria VA, 22313-1450

**Request for Certificate of Correction under 37 C.F.R. § 1.323**

This paper requests a Certificate of Correction under 37 C.F.R. § 1.323 for the United States patent identified above. Accompanying this request is a Certificate of Correction form PTO/SB/44 containing the text of this correction. Applicant submits the fee due to corrections being:

- (1) of a clerical nature,
- (2) of a typographical nature, or
- (3) a mistake of minor character.

This request does not involve changes that would:

- (1) constitute new matter or
- (2) require reexamination

Respectfully,  
/william grecia/  
William Grecia  
Applicant Pro Se

## Electronic Patent Application Fee Transmittal

<b>Application Number:</b>	13740086
<b>Filing Date:</b>	11-Jan-2013
<b>Title of Invention:</b>	PERSONALIZED DIGITAL MEDIA ACCESS SYSTEM - PDMAS PART II
<b>First Named Inventor/Applicant Name:</b>	William Grecia
<b>Filer:</b>	William Grecia
<b>Attorney Docket Number:</b>	

Filed as Small Entity

### Utility under 35 USC 111(a) Filing Fees

Description	Fee Code	Quantity	Amount	Sub-Total in USD(\$)
<b>Basic Filing:</b>				
<b>Pages:</b>				
<b>Claims:</b>				
<b>Miscellaneous-Filing:</b>				
<b>Petition:</b>				
<b>Patent-Appeals-and-Interference:</b>				
<b>Post-Allowance-and-Post-Issuance:</b>				
Certificate of Correction	1811	1	100	100

**Extension-of-Time:**

EWS-003731

Description	Fee Code	Quantity	Amount	Sub-Total in USD(\$)
<b>Miscellaneous:</b>				
<b>Total in USD (\$)</b>				<b>100</b>

## Electronic Acknowledgement Receipt

<b>EFS ID:</b>	16806213
<b>Application Number:</b>	13740086
<b>International Application Number:</b>	
<b>Confirmation Number:</b>	7081
<b>Title of Invention:</b>	PERSONALIZED DIGITAL MEDIA ACCESS SYSTEM - PDMAS PART II
<b>First Named Inventor/Applicant Name:</b>	William Grecia
<b>Customer Number:</b>	70984
<b>Filer:</b>	William Grecia
<b>Filer Authorized By:</b>	
<b>Attorney Docket Number:</b>	
<b>Receipt Date:</b>	10-SEP-2013
<b>Filing Date:</b>	11-JAN-2013
<b>Time Stamp:</b>	08:46:07
<b>Application Type:</b>	Utility under 35 USC 111(a)

### Payment information:

Submitted with Payment	yes
Payment Type	Credit Card
Payment was successfully received in RAM	\$100
RAM confirmation Number	9595
Deposit Account	
Authorized User	

### File Listing:

Document Number	Document Description	File Name	File Size(Bytes)/ Message Digest	Multi Part Zip	Pages (if appl.)
					3

1	Request for Certificate of Correction	sb0044-860patent-c.pdf	164520 824f701a973de3a1139f2c9ca74e9fec6b179bd8	no	2
<b>Warnings:</b>					
<b>Information:</b>					
2	Request for Certificate of Correction	COC2.pdf	129577 08e771732e803f2b8c9dfca8b0930bfe3efced61	no	1
<b>Warnings:</b>					
<b>Information:</b>					
3	Fee Worksheet (SB06)	fee-info.pdf	29542 f114b0ea71952d470c1bbfbf353382f731639edc	no	2
<b>Warnings:</b>					
<b>Information:</b>					
<b>Total Files Size (in bytes):</b>				323639	

**This Acknowledgement Receipt evidences receipt on the noted date by the USPTO of the indicated documents, characterized by the applicant, and including page counts, where applicable. It serves as evidence of receipt similar to a Post Card, as described in MPEP 503.**

**New Applications Under 35 U.S.C. 111**

**If a new application is being filed and the application includes the necessary components for a filing date (see 37 CFR 1.53(b)-(d) and MPEP 506), a Filing Receipt (37 CFR 1.54) will be issued in due course and the date shown on this Acknowledgement Receipt will establish the filing date of the application.**

**National Stage of an International Application under 35 U.S.C. 371**

**If a timely submission to enter the national stage of an international application is compliant with the conditions of 35 U.S.C. 371 and other applicable requirements a Form PCT/DO/EO/903 indicating acceptance of the application as a national stage submission under 35 U.S.C. 371 will be issued in addition to the Filing Receipt, in due course.**

**New International Application Filed with the USPTO as a Receiving Office**

**If a new international application is being filed and the international application includes the necessary components for an international filing date (see PCT Article 11 and MPEP 1810), a Notification of the International Application Number and of the International Filing Date (Form PCT/RO/105) will be issued in due course, subject to prescriptions concerning national security, and the date shown on this Acknowledgement Receipt will establish the international filing date of the application.**





UNITED STATES PATENT AND TRADEMARK OFFICE

UNITED STATES DEPARTMENT OF COMMERCE  
United States Patent and Trademark Office  
Address: COMMISSIONER FOR PATENTS  
P.O. Box 1450  
Alexandria, Virginia 22313-1450  
www.uspto.gov

APPLICATION NO.	ISSUE DATE	PATENT NO.	ATTORNEY DOCKET NO.	CONFIRMATION NO.
13/740,086	09/10/2013	8533860		7081

70984 7590 08/21/2013  
The STR3EM Team  
2885 Sanford Ave SW #13208  
Grandville, MI 49418

**ISSUE NOTIFICATION**

The projected patent number and issue date are specified above.

**Determination of Patent Term Adjustment under 35 U.S.C. 154 (b)**  
(application filed on or after May 29, 2000)

The Patent Term Adjustment is 0 day(s). Any patent to issue from the above-identified application will include an indication of the adjustment on the front page.

If a Continued Prosecution Application (CPA) was filed in the above-identified application, the filing date that determines Patent Term Adjustment is the filing date of the most recent CPA.

Applicant will be able to obtain more detailed information by accessing the Patent Application Information Retrieval (PAIR) WEB site (<http://pair.uspto.gov>).

Any questions regarding the Patent Term Extension or Adjustment determination should be directed to the Office of Patent Legal Administration at (571)-272-7702. Questions relating to issue and publication fee payments should be directed to the Application Assistance Unit (AAU) of the Office of Data Management (ODM) at (571)-272-4200.

APPLICANT(s) (Please see PAIR WEB site <http://pair.uspto.gov> for additional applicants):

William Grecia, Brooklyn, NY;

The United States represents the largest, most dynamic marketplace in the world and is an unparalleled location for business investment, innovation, and commercialization of new technologies. The USA offers tremendous resources and advantages for those who invest and manufacture goods here. Through SelectUSA, our nation works to encourage and facilitate business investment. To learn more about why the USA is the best country in the world to develop technology, manufacture products, and grow your business, visit [SelectUSA.gov](http://SelectUSA.gov).



UNITED STATES PATENT AND TRADEMARK OFFICE

UNITED STATES DEPARTMENT OF COMMERCE  
United States Patent and Trademark Office  
Address: COMMISSIONER FOR PATENTS  
P.O. Box 1450  
Alexandria, Virginia 22313-1450  
www.uspto.gov

APPLICATION NO.	FILING DATE	FIRST NAMED INVENTOR	ATTORNEY DOCKET NO.	CONFIRMATION NO.
13/740,086	01/11/2013	William Grecia		7081

70984 7590 08/05/2013  
The STR3EM Team  
2885 Sanford Ave SW #13208  
Grandville, MI 49418

EXAMINER
----------

TRAN, TRI MINH

ART UNIT	PAPER NUMBER
2494	

NOTIFICATION DATE	DELIVERY MODE
08/05/2013	ELECTRONIC

**Please find below and/or attached an Office communication concerning this application or proceeding.**

The time period for reply, if any, is set in the attached communication.

Notice of the Office communication was sent electronically on above-indicated "Notification Date" to the following e-mail address(es):

cs2cd@yahoo.com  
sa.cs2cd@gmail.com  
bally5@aol.com

NOTE

Below are the corrected Amendments that are based on the claims amended by the Examiner in the Notice of Allowance mailed on May 31, 2013. Note that the proposed amendments submitted by the Applicant under Rule 312 also filed on the same day of May 31 2013 include changes already addressed in the examiner's amendment in the aforementioned Notice of Allowance.

Claim Amendments

1. (Currently amended) *A method for authorizing access to digital content using a cloud system, the cloud system comprising connected modules in operation as one or more of a cloud computing or a cloud storage in connection with devices and users, wherein the digital content ~~being~~is at least one of encrypted or not encrypted, the method facilitating access rights between a plurality of data processing devices, the method comprising:*

*receiving ~~[[the]]~~a digital content access request from at least one communications console of the plurality of data processing devices, the access request being a read or write request of metadata of the digital content, wherein the read or write request of metadata is performed in connection with a combination of at least one device and the cloud system, the request comprising a verification token provided by a first user corresponding to the digital content, wherein the verification token is one or more of a password, e-mail address, payment system, credit card, authorize ready device, rights token, or one or more redeemable instruments of trade;*

*authenticating the verification token;*

Art Unit: 2494

*establishing a connection with the at least one communications console, wherein the communications console is a combination of a graphic user interface (GUI) and an Application[[s]] Programmable Interface (API) wherein the API is obtained from a verified web service, the web service capable of facilitating a two way data exchange to complete a verification process wherein the data exchange session comprises at least one identification reference;*

*requesting the at least one identification reference from the at least one communications console, wherein the identification reference comprises one or more of a verified web service account identifier, letter, number, rights token, e-mail, password, access time, serial number, address, manufacturer identification, checksum, operating system version, browser version, credential, cookie, or key;*

*receiving the at least one identification reference from the at least one communications console; and*

*writing at least one of the verification token or the identification reference into the metadata.*

*2. (Currently amended) The method according to claim 1, wherein the access request being a request from the first user through a data processing device of the plurality of data processing devices; or*

*wherein the access request being a request from one or more secondary users in network to the first user;*

*wherein [[said]]the secondary users are validated by a membership web service.*

Art Unit: 2494

3. *(Original) The method according to claim 2, wherein the metadata comprises one or more of a software or contents of a web page.*

4. *(Previously amended) The method according to claim 3, wherein the verification token represents verification from a provider of the token to grant access rights to the first user.*

5. *(Previously amended) The method according to claim 3, wherein the digital content is shared among one or more users according to a membership status.*

6. *(Currently amended) The method according to claim 5, wherein the one or more users are a network of recognized human beings using machines or recognized automated computerized mechanisms programmed by human beings, the recognition of *[[said ]]*the one or more users being validated by the membership status of the membership web service.*

7. *(Currently amended) The method according to claim 6, wherein the digital content access request is from a user using at least one of a computer or a phone hosting an operating system running an application.*

Art Unit: 2494

8. (Previously amended) The method of claim 7, wherein the verification token comprises at least one token selected from the group consisting of a purchase permission, a rental permission, or a membership permission;

wherein the at least one of purchase permission, rental permission, or membership permission is represented by one or more of a letter, number, combination of letters and numbers, rights token, successful payment reference, phrase, name, membership credentials, image, logo, tag, service name, authorization, list, interface button, downloadable program, or an instrument of trade.

9. (Currently amended) A system for authorizing access to digital content using a worldwide cloud system infrastructure, the worldwide cloud system infrastructure comprising connected modules in operation as computing and storage, the computing and storage comprising a server, a database, devices and users, wherein the digital content ~~being~~ is at least one of encrypted or not encrypted, the system facilitating access rights between a plurality of data processing devices, the system working as a front-end agent for access rights authentication between the plurality of data processing devices, the system further comprising:

a first receipt module, the first receipt module receiving ~~[[the]]~~ a digital content access request from at least one communications console of the plurality of data processing devices, the access request being a read or write request of metadata of the digital content, wherein the read or write request of metadata is performed in connection with a combination of a device, the server, the database and the cloud

Art Unit: 2494

*system, the metadata further comprises one or more of a software or contents of a web page, the request comprising a verification token provided by a user corresponding to the digital content, wherein the verification token is one or more of a password, e-mail address, payment system, credit card, authorize ready device, rights token, or one or more redeemable instruments of trade;*

*an authentication module, the authentication module authenticating the verification token;*

*a connection module, the connection module establishing a connection with the at least one communications console, wherein the communications console is a combination of a graphic user interface (GUI) and an Application[[s]] Programmable Interface (API) wherein the API is obtained from a verified web service, the web service capable of facilitating a two way data exchange to complete a verification process wherein the data exchange session comprises at least one identification reference;*

*a request module, the request module requesting the at least one identification reference from the at least one communications console, wherein the identification reference comprises one or more of a verified web service account identifier, letter, number, rights token, e-mail, password, access time, serial number, address, manufacturer identification, checksum, operating system version, browser version, credential, cookie, or key;*

*a secondary receipt module, the secondary receipt module receiving the at least one identification reference from the at least one communications console; and*

Art Unit: 2494

*a branding module, the branding module writing at least one of the verification token or the identification reference into the metadata.*

*10. (original) The system of claim 9, wherein the verification token comprises at least one token selected from the group consisting of a purchase permission, a rental permission, or a membership permission;*

*wherein the at least one of purchase permission, rental permission, or membership permission is represented by one or more of a tag, letter, number, combination of letters and numbers, rights token, successful payment reference, phrase, name, membership credentials, image, logo, service name, authorization, list, interface button, downloadable program, or an instrument of trade.*

*11. (Currently amended) A non-transitory computer medium comprising a program code, the program code being a part of an operating system software or downloaded in sections from a web server, the operating system software program coupled with a user executing a method for authorizing access to digital content wherein the program code, when executed in a processor for facilitating access rights between a plurality of data processing devices, performs the following steps of:*

*receiving ~~[[the]]~~ a digital content access request from at least one communications console of the plurality of data processing devices, the access request being a read or write request of metadata of the digital content, wherein the read or write request of metadata is performed in connection with a combination of the*



Art Unit: 2494

*operating system software program and [[the]]a cloud system, the request comprising a verification token provided by the user corresponding to the digital content, wherein the verification token is one or more of a password, e-mail address, payment system, credit card, authorize ready device, rights token, key, file, or one or more redeemable instruments of trade;*

*authenticating the verification token;*

*establishing a connection with the at least one communications console, wherein the communications console is a combination of a graphic user interface (GUI) and an Applications Programmable Interface (API) wherein the API is obtained from a verified web service, the web service capable of facilitating a two way data exchange to complete a verification process wherein the data exchange session comprises at least one identification reference;*

*requesting the at least one identification reference from the at least one communications console, wherein the identification reference is one or more of a verified web service account identifier, letter, number, rights token, e-mail, password, access time, serial number, address, manufacturer identification, checksum, operating system version, browser version, credential, cookie, or key;*

*receiving the at least one identification reference from the at least one communications console; and*

*writing at least one of the verification token or the identification reference into the metadata.*

Art Unit: 2494

*12. (Previously amended) The non-transitory computer medium according to claim 11, wherein the access request is a request from the user providing a credential to a membership web service through a data processing device of the plurality of data processing devices, the user being a human user establishing a permission to the digital content.*

*13. (Previously amended) The non-transitory computer medium of claim 12, wherein the verification token comprises at least one of a purchase permission, a rental permission, or a membership permission;*

*wherein the at least one of purchase permission, rental permission, or membership permission is represented by one or more of a tag, letter, number, combination of letters and numbers, successful payment reference, phrase, name, membership credential, image, logo, service name, authorization, list, key, file, interface button, downloadable program, or an instrument of trade.*

*14. (Previously amended) The non-transitory computer medium according to claim 13, wherein the verification token represents verification from a provider that a product was acquired.*

Art Unit: 2494

15. (Currently amended) *The non-transitory computer medium according to claim 13, wherein the digital content ~~internet connected~~ asset is accessed according to a membership status.*

16. (Previously amended) *The non-transitory computer medium according to claim 15, wherein the membership status is connected to an application programmable interface.*

17. (Previously amended) *The non-transitory computer medium according to claim 15, wherein a remote control operation exist.*

18. (Previously amended) *The non-transitory computer medium according to claim 16, wherein the application programmable interface is connected to a graphic user interface.*

19. (Previously amended) *The non-transitory computer medium according to claim 17, wherein the digital content is shared with one or more secondary users.*

20. (Previously amended) *The non-transitory computer medium according to claim 19, wherein the digital content is shared with the secondary user according to a period of time.*

Art Unit: 2494

21. (Currently amended) A[[n]] computer product comprising a memory, a CPU, a communications console and a non-transitory computer usable medium, the computer usable medium having an operating system stored therein, the computer product further comprising a customization module, the computer product authorizing access to digital content ~~a data source~~, wherein the digital content ~~data source~~ is at least one of an application, a video, or a video game, wherein the digital content is at least one of encrypted or not encrypted, the computer product configured to perform the steps of:

receiving the digital content access request from the communications console, the access request being a read or write request of metadata of the digital content, the metadata of the digital content being one or more of a database or storage in connection to the computer product, the request comprising a verification token corresponding to the digital content, the verification token is handled by the user as a redeemable instrument, wherein the verification token comprises at least one of a purchase permission, a rental permission, or a membership permission, wherein the at least one of purchase permission, rental permission, or membership permission being represented by one or more of a tag, a letter, a number, a combination of letters and numbers, a successful payment, a rights token, a phrase, a name, a membership credential, an image, a logo, a service name, an authorization, a list, an interface button, a downloadable program, or the redeemable instrument;

authenticating the verification token;

Art Unit: 2494

*establishing a connection with the communications console, wherein the communications console is a combination of a graphic user interface (GUI) and an Applications Programmable Interface (API) wherein the API is obtained from a verified web service, the web service capable of facilitating a two way data exchange to complete a verification process wherein the data exchange session comprises at least one identification reference;*

*requesting the at least one identification reference from the at least one communications console, wherein the identification reference comprises one or more of a verified web service account identifier, letter, number, rights token, e-mail, password, access time, serial number, address, manufacturer identification, checksum, operating system version, browser version, credential, cookie, or key;*

*receiving the at least one identification reference from the communications console; and*

*writing at least one of the verification token or the identification reference into the said metadata.*

*22. (Previously amended) The computer product according to claim 21, wherein the access request is a request from a first user, the first user is a human user in operation of the computer product and establishes first access to the digital content; or*

*wherein the access request is a request from a secondary user, the secondary user is a human user in operation of the computer product and establishes secondary access to the same digital content as first established for access by the first user.*

Art Unit: 2494

23. *(Original) The computer product according to claim 21, wherein the customization module customizes the tag.*

24. *(Original) The computer product according to claim 21, wherein the customization module customizes a user access panel.*

25. *(Previously amended) The computer product according to claim 22, wherein the digital content is monitored for access using a worldwide cloud system infrastructure, the worldwide cloud system infrastructure comprising internet connected modules in operation as computing and storage services in connection to the computer product.*

26. *(Original) The computer product according to claim 22, wherein the verification token is connected to a royalty scheme.*

27. *(Original) The computer product according to claim 25, wherein the access is allowed according to a permission facilitated by a web service working as a front-end agent to the worldwide cloud system infrastructure.*

28. *(Original) The computer product according to claim 25, wherein the computer product is a device of a plurality of devices in a network of the user.*

Art Unit: 2494

*29. (Original) The computer product according to claim 28, wherein the device is a computer or a phone.*

*30. (Original) The computer product according to claim 29, wherein a remote control operation exist.*

IN THE UNITED STATES PATENT AND TRADEMARK OFFICE

In re application of:

William Grecia

Application No.: 13/740,086

Filed: January 11, 2013

For: PERSONALIZED DIGITAL MEDIA  
ACCESS SYSTEM – PDMAS PART II

Examiner: Tran, Tri Minh

Art Unit: 2494

CNF# 6106

**AMENDMENT UNDER 37 C.F.R. 1.312**

Assistant Commissioner for Patents

P. O. Box 1450

Alexandria VA, 22313-1450

Sir:

To correct formalities, please amend the above-identified application as follows:

IN THE CLAIMS

Please amend all claims labeled as (Currently Amended). All claims are reproduced starting on page 2 of this document for convenient reference. No new matter has been added by way of this amendment and requires no substantial amount of additional work on the part of the office.

Respectfully Submitted,

/william grecia/

William Grecia

Applicant Pro Se



<b>Response to Rule 312 Communication</b>	<b>Application No.</b> 13/740,086	<b>Applicant(s)</b> GRECIA, WILLIAM
	<b>Examiner</b> TRI TRAN	<b>Art Unit</b> 2494

*-- The MAILING DATE of this communication appears on the cover sheet with the correspondence address --*

1.  The amendment filed on 31 May 2013 under 37 CFR 1.312 has been considered, and has been:
- a)  entered.
  - b)  entered as directed to matters of form not affecting the scope of the invention.
  - c)  disapproved because the amendment was filed after the payment of the issue fee.  
Any amendment filed after the date the issue fee is paid must be accompanied by a petition under 37 CFR 1.313(c)(1) and the required fee to withdraw the application from issue.
  - d)  disapproved. See explanation below.
  - e)  entered in part. See explanation below.

see attached Response to Amendment under Rule 312 sheet

/Jung Kim/ Supervisory Patent Examiner, Art Unit 2494	/TRI TRAN/ Examiner, Art Unit 2494
--	---------------------------------------



UNITED STATES PATENT AND TRADEMARK OFFICE

UNITED STATES DEPARTMENT OF COMMERCE
United States Patent and Trademark Office
Address: COMMISSIONER FOR PATENTS
P.O. Box 1450
Alexandria, Virginia 22313-1450
www.uspto.gov

Table with 5 columns: APPLICATION NO., FILING DATE, FIRST NAMED INVENTOR, ATTORNEY DOCKET NO., CONFIRMATION NO.
Row 1: 13/740,086, 01/11/2013, William Gracia, (blank), 7081
Row 2: 70984, 7590, 08/01/2013, (blank), (blank)
Row 3: The STR3EM Team, 2885 Sanford Ave SW #13208, Grandville, MI 49418, (blank), (blank)
Row 4: (blank), (blank), (blank), EXAMINER, (blank)
Row 5: (blank), (blank), (blank), TRAN, TRI MINH, (blank)
Row 6: (blank), (blank), (blank), ART UNIT, PAPER NUMBER
Row 7: (blank), (blank), (blank), 2494, (blank)
Row 8: (blank), (blank), (blank), NOTIFICATION DATE, DELIVERY MODE
Row 9: (blank), (blank), (blank), 08/01/2013, ELECTRONIC

Please find below and/or attached an Office communication concerning this application or proceeding.

The time period for reply, if any, is set in the attached communication.

Notice of the Office communication was sent electronically on above-indicated "Notification Date" to the following e-mail address(es):

- cs2cd@yahoo.com
sa.cs2cd@gmail.com
bally5@aol.com



UNITED STATES PATENT AND TRADEMARK OFFICE

Commissioner for Patents  
United States Patent and Trademark Office  
P.O. Box 1450  
Alexandria, VA 22313-1450  
www.uspto.gov

Application No. : 13740086  
Applicant : Grecia  
Filing Date : 01/11/2013  
Date Mailed : 08/01/2013

## NOTICE TO FILE CORRECTED APPLICATION PAPERS

### *Notice of Allowance Mailed*

This application has been accorded an Allowance Date and is being prepared for issuance. The application, however, is incomplete for the reasons below.

**Applicant is given 1 month from the mail date of this Notice, or the time remaining from the Notice of Allowance and Fee(s) Due, whichever is longer, within which to respond.**

The application is not in compliance with 37 CFR 1.78, as indicated in the attachment. The consequences of failure to respond within the above-identified time period are set forth in the attachment.

Even if the Office has recognized a benefit claim and has entered it into the Office's database and included it on applicant's filing receipt, the benefit claim is not a proper benefit claim unless the reference in compliance with 37 CFR 1.78 is included, depending upon the application's filing date and as indicated in the attachment, in an application data sheet or in the first sentence(s) of the specification and all other requirements are met.

**This period for reply is NOT extendable under 37 CFR 1.136(a).**

See attachment.

*A copy of this notice **MUST** be returned with the reply. Please address response to "Mail Stop Issue Fee, Commissioner for Patents, P.O. Box 1450, Alexandria, VA 22313-1450".*

/Jonathan Robbins/  
Publication Branch  
Office of Data Management  
(571) 272-4200

EWS-003753

**Application No. 13740086**

**APPLICATION FILED ON OR AFTER SEPTEMBER 16, 2012 AND BEFORE MARCH 16, 2013,  
NOT IN COMPLIANCE WITH 37 CFR 1.78**

- The 37 CFR 1.78(a)(2) reference on the application data sheet does not indicate the relationship (continuation, division, continuation-in-part) to the prior U.S. nonprovisional application or international application designating the U.S. See document coded dated , listing application number(s) .
- The 37 CFR 1.78(a)(2) reference on the application data sheet does not provide the U.S. nonprovisional application number (series code and serial number) or, with respect to an international PCT application designating the U.S., it provides the international application number or international filing date but not both. See document coded dated , in which the following is missing: .
- The 37 CFR 1.78(a)(2) reference on the application data sheet shows an incorrect, incomplete, or illegible U.S. nonprovisional application number, international PCT application number, or international PCT filing date. See document coded dated , in which the following error was made: .
- The 37 CFR 1.78(a)(2) reference to the prior U.S. nonprovisional application or international application designating the U.S. is not present on an application data sheet, thus removing the validating link under 35 U.S.C. 119(a)-(d) to a prior foreign application or under 35 U.S.C. 119(e) to a prior U.S. provisional application.
- The 37 CFR 1.78(a)(2) reference to the prior U.S. nonprovisional application or international application designating the U.S. is not present on an application data sheet.
- The 37 CFR 1.78(a)(5) reference to the prior U.S. provisional application is not present on an application data sheet.
- The 37 CFR 1.78(a)(5) reference to the prior U.S. provisional application on an application data sheet does not provide the provisional application number (series code and serial number). See document coded dated , in which the following is missing: .
- The 37 CFR 1.78(a)(5) reference to the prior U.S. provisional application on an application data sheet shows an incorrect, incomplete, or illegible U.S. provisional application number. See document coded dated , in which the following error was made: .
- Other: .

**HOW TO RESPOND**

A proper response to this notice would include any one of: (1) a corrected Application Data Sheet (ADS) pursuant to 37 CFR 1.76(c) which provides benefit information that complies with 37 CFR 1.78(a)(2) or 37 CFR 1.78(a)(5) or (2) a petition filed pursuant to the provisions of 37 CFR 1.78(a)(3) or 37 CFR 1.78(a)(6) if the benefit information from the document identified above by code and date does not accurately reflect the benefits under 35 U.S.C. 119(e), 120, 121 or 365(c) as claimed by applicant (a grantable petition would include a corrected ADS as required by 37 CFR 1.78(a)(3)(i) or 37 CFR 1.78(a)(6)(i)). Such amendments to the specification or supplemental ADS submission may be filed after payment of the issue fee if limited to informalities noted herein. See Waiver of 37 CFR 1.312 for Document Required by Office of Patent Publication, 1280 Off. Gaz. Patent Office 918 (March 23, 2004).

**WARNING:** If Applicant fails to timely submit a proper response, the benefit information will be deleted and the patent will be printed without the benefit information present.

IN THE UNITED STATES PATENT AND TRADEMARK OFFICE

In re application of:

William Grecia

Application No.: 13/740,086

Filed: January 11, 2013

For: PERSONALIZED DIGITAL MEDIA

ACCESS SYSTEM - PDMAS PART II

Examiner: Tran, Tri

Art Unit: 2494

CNF# 7081

**ADS Submission**

Assistant Commissioner for Patents

P. O. Box 1450

Alexandria VA, 22313-1450

Sir:

In response to office mailing 8/1/2013: **Mail PUB other miscellaneous communication to applicant**

Applicant submits a PTO/SB/14 Application Data Sheet 37 CFR 1.76

Respectfully,



William Grecia

Applicant Pro Se

## Electronic Acknowledgement Receipt

<b>EFS ID:</b>	16473262
<b>Application Number:</b>	13740086
<b>International Application Number:</b>	
<b>Confirmation Number:</b>	7081
<b>Title of Invention:</b>	PERSONALIZED DIGITAL MEDIA ACCESS SYSTEM - PDMAS PART II
<b>First Named Inventor/Applicant Name:</b>	William Grecia
<b>Customer Number:</b>	70984
<b>Filer:</b>	William Grecia
<b>Filer Authorized By:</b>	
<b>Attorney Docket Number:</b>	
<b>Receipt Date:</b>	01-AUG-2013
<b>Filing Date:</b>	11-JAN-2013
<b>Time Stamp:</b>	10:08:09
<b>Application Type:</b>	Utility under 35 USC 111(a)

### Payment information:

Submitted with Payment	no
------------------------	----

### File Listing:

Document Number	Document Description	File Name	File Size(Bytes)/ Message Digest	Multi Part /.zip	Pages (if appl.)
1	Application Data Sheet	SB0014-pdmasII.pdf	1483217 <small>98ea9ee00d179c57324b7da9e13b3c82f934db8d</small>	no	4

### Warnings:

### Information:

EWS-003756

2	Transmittal Letter	PDMASIII-adsletterm.pdf	80488 2cc68bf76a0dc53dad0469dc67c9c5e9fa0d beff	no	1
---	--------------------	-------------------------	---	----	---

**Warnings:**

**Information:**

<b>Total Files Size (in bytes):</b>	1563705
-------------------------------------	---------

**This Acknowledgement Receipt evidences receipt on the noted date by the USPTO of the indicated documents, characterized by the applicant, and including page counts, where applicable. It serves as evidence of receipt similar to a Post Card, as described in MPEP 503.**

**New Applications Under 35 U.S.C. 111**

**If a new application is being filed and the application includes the necessary components for a filing date (see 37 CFR 1.53(b)-(d) and MPEP 506), a Filing Receipt (37 CFR 1.54) will be issued in due course and the date shown on this Acknowledgement Receipt will establish the filing date of the application.**

**National Stage of an International Application under 35 U.S.C. 371**

**If a timely submission to enter the national stage of an international application is compliant with the conditions of 35 U.S.C. 371 and other applicable requirements a Form PCT/DO/EO/903 indicating acceptance of the application as a national stage submission under 35 U.S.C. 371 will be issued in addition to the Filing Receipt, in due course.**

**New International Application Filed with the USPTO as a Receiving Office**

**If a new international application is being filed and the international application includes the necessary components for an international filing date (see PCT Article 11 and MPEP 1810), a Notification of the International Application Number and of the International Filing Date (Form PCT/RO/105) will be issued in due course, subject to prescriptions concerning national security, and the date shown on this Acknowledgement Receipt will establish the international filing date of the application.**

Under the Paperwork Reduction Act of 1995, no persons are required to respond to a collection of information unless it contains a valid OMB control number.

<b>Application Data Sheet 37 CFR 1.76</b>		Attorney Docket Number	
		Application Number	
Title of Invention	PERSONALIZED DIGITAL MEDIA ACCESS SYSTEM - PDMAS PART II		
The application data sheet is part of the provisional or nonprovisional application for which it is being submitted. The following form contains the bibliographic data arranged in a format specified by the United States Patent and Trademark Office as outlined in 37 CFR 1.76. This document may be completed electronically and submitted to the Office in electronic format using the Electronic Filing System (EFS) or the document may be printed and included in a paper filed application.			

**Secrecy Order 37 CFR 5.2**

<input type="checkbox"/>	Portions or all of the application associated with this Application Data Sheet may fall under a Secrecy Order pursuant to 37 CFR 5.2 (Paper filers only. Applications that fall under Secrecy Order may not be filed electronically.)
--------------------------	---

**Applicant Information:**

<b>Applicant 1</b>					<input type="button" value="Remove"/>
<b>Applicant Authority</b> <input checked="" type="radio"/> Inventor		<input type="radio"/> Legal Representative under 35 U.S.C. 117		<input type="radio"/> Party of Interest under 35 U.S.C. 118	
<b>Prefix</b>	<b>Given Name</b>	<b>Middle Name</b>	<b>Family Name</b>	<b>Suffix</b>	
Mr.	William		Grecia		
<b>Residence Information (Select One)</b> <input checked="" type="radio"/> US Residency <input type="radio"/> Non US Residency <input type="radio"/> Active US Military Service					
<b>City</b>	Brooklyn	<b>State/Province</b>	NY	<b>Country of Residence i</b>	US
<b>Citizenship under 37 CFR 1.41(b) i</b>		US			
<b>Mailing Address of Applicant:</b>					
<b>Address 1</b>	2885 Sanford Ave SW				
<b>Address 2</b>	#13208				
<b>City</b>	Grandville	<b>State/Province</b>	MI		
<b>Postal Code</b>	49418	<b>Country<sup>i</sup></b>	US		
All Inventors Must Be Listed - Additional Inventor Information blocks may be generated within this form by selecting the <b>Add</b> button.					<input type="button" value="Add"/>

**Correspondence Information:**

Enter either Customer Number or complete the Correspondence Information section below. For further information see 37 CFR 1.33(a).			
<input type="checkbox"/> An Address is being provided for the correspondence Information of this application.			
<b>Customer Number</b>	70984		
<b>Email Address</b>	sa.cs2cd@gmail.com	<input type="button" value="Add Email"/>	<input type="button" value="Remove Email"/>

**Application Information:**

<b>Title of the Invention</b>	PERSONALIZED DIGITAL MEDIA ACCESS SYSTEM - PDMAS PART II		
<b>Attorney Docket Number</b>		<b>Small Entity Status Claimed</b>	<input checked="" type="checkbox"/>
<b>Application Type</b>	Nonprovisional		
<b>Subject Matter</b>	Utility		
<b>Suggested Class (if any)</b>		<b>Sub Class (if any)</b>	
<b>Suggested Technology Center (if any)</b>			
<b>Total Number of Drawing Sheets (if any)</b>	7	<b>Suggested Figure for Publication (if any)</b>	

EWS-003758



<b>Application Data Sheet 37 CFR 1.76</b>	Attorney Docket Number	
	Application Number	
Title of Invention	PERSONALIZED DIGITAL MEDIA ACCESS SYSTEM - PDMAS PART II	

**Publication Information:**

<input type="checkbox"/>	Request Early Publication (Fee required at time of Request 37 CFR 1.219)
<input type="checkbox"/>	<b>Request Not to Publish.</b> I hereby request that the attached application not be published under 35 U.S. C. 122(b) and certify that the invention disclosed in the attached application <b>has not and will not</b> be the subject of an application filed in another country, or under a multilateral international agreement, that requires publication at eighteen months after filing.

**Representative Information:**

Representative information should be provided for all practitioners having a power of attorney in the application. Providing this information in the Application Data Sheet does not constitute a power of attorney in the application (see 37 CFR 1.32). Enter either Customer Number or complete the Representative Name section below. If both sections are completed the Customer Number will be used for the Representative Information during processing.			
Please Select One:	<input checked="" type="radio"/> Customer Number	<input type="radio"/> US Patent Practitioner	<input type="radio"/> Limited Recognition (37 CFR 11.9)
Customer Number	70984		

**Domestic Benefit/National Stage Information:**

This section allows for the applicant to either claim benefit under 35 U.S.C. 119(e), 120, 121, or 365(c) or indicate National Stage entry from a PCT application. Providing this information in the application data sheet constitutes the specific reference required by 35 U.S.C. 119(e) or 120, and 37 CFR 1.78(a)(2) or CFR 1.78(a)(4), and need not otherwise be made part of the specification.					
Prior Application Status	Patented		<a href="#">Remove</a>		
Application Number	Continuity Type	Prior Application Number	Filing Date (YYYY-MM-DD)	Patent Number	Issue Date (YYYY-MM-DD)
13397517	Continuation of	12985351	2012-02-15	8402555	2013-03-19
Prior Application Status	Abandoned		<a href="#">Remove</a>		
Application Number	Continuity Type	Prior Application Number	Filing Date (YYYY-MM-DD)		
12985351	Continuation of	12728218	2011-01-06		
Prior Application Status	Abandoned		<a href="#">Remove</a>		
Application Number	Continuity Type	Prior Application Number	Filing Date (YYYY-MM-DD)		
12728218			2010-03-21		
Additional Domestic Benefit/National Stage Data may be generated within this form by selecting the <b>Add</b> button.					<a href="#">Add</a>

**Foreign Priority Information:**

This section allows for the applicant to claim benefit of foreign priority and to identify any prior foreign application for which priority is not claimed. Providing this information in the application data sheet constitutes the claim for priority as required by 35 U.S.C. 119(b) and 37 CFR 1.55(a).
---

Under the Paperwork Reduction Act of 1995, no persons are required to respond to a collection of information unless it contains a valid OMB control number.

<b>Application Data Sheet 37 CFR 1.76</b>	Attorney Docket Number	
	Application Number	
Title of Invention	PERSONALIZED DIGITAL MEDIA ACCESS SYSTEM - PDMAS PART II	

			<input type="button" value="Remove"/>
Application Number	Country <sup>i</sup>	Parent Filing Date (YYYY-MM-DD)	Priority Claimed
			<input checked="" type="radio"/> Yes <input type="radio"/> No
Additional Foreign Priority Data may be generated within this form by selecting the <b>Add</b> button.			<input type="button" value="Add"/>

**Assignee Information:**

Providing this information in the application data sheet does not substitute for compliance with any requirement of part 3 of Title 37 of the CFR to have an assignment recorded in the Office.				
<b>Assignee 1</b>				<input type="button" value="Remove"/>
If the Assignee is an Organization check here. <input type="checkbox"/>				
Prefix	Given Name	Middle Name	Family Name	Suffix
<b>Mailing Address Information:</b>				
Address 1				
Address 2				
City		State/Province		
Country <sup>i</sup>		Postal Code		
Phone Number		Fax Number		
Email Address				
Additional Assignee Data may be generated within this form by selecting the <b>Add</b> button.				<input type="button" value="Add"/>

**Signature:**

A signature of the applicant or representative is required in accordance with 37 CFR 1.33 and 10.18. Please see 37 CFR 1.4(d) for the form of the signature.					
<b>Signature</b>	/william grecia/		Date (YYYY-MM-DD)	2013-08-01	
<b>First Name</b>	William	<b>Last Name</b>	Grecia	<b>Registration Number</b>	70984

This collection of information is required by 37 CFR 1.76. The information is required to obtain or retain a benefit by the public which is to file (and by the USPTO to process) an application. Confidentiality is governed by 35 U.S.C. 122 and 37 CFR 1.14. This collection is estimated to take 23 minutes to complete, including gathering, preparing, and submitting the completed application data sheet form to the USPTO. Time will vary depending upon the individual case. Any comments on the amount of time you require to complete this form and/or suggestions for reducing this burden, should be sent to the Chief Information Officer, U.S. Patent and Trademark Office, U.S. Department of Commerce, P.O. Box 1450, Alexandria, VA 22313-1450. DO NOT SEND FEES OR COMPLETED FORMS TO THIS ADDRESS. **SEND TO: Commissioner for Patents, P.O. Box 1450, Alexandria, VA 22313-1450.**

EWS-003760

# Privacy Act Statement

The Privacy Act of 1974 (P.L. 93-579) requires that you be given certain information in connection with your submission of the attached form related to a patent application or patent. Accordingly, pursuant to the requirements of the Act, please be advised that: (1) the general authority for the collection of this information is 35 U.S.C. 2(b)(2); (2) furnishing of the information solicited is voluntary; and (3) the principal purpose for which the information is used by the U.S. Patent and Trademark Office is to process and/or examine your submission related to a patent application or patent. If you do not furnish the requested information, the U.S. Patent and Trademark Office may not be able to process and/or examine your submission, which may result in termination of proceedings or abandonment of the application or expiration of the patent.

The information provided by you in this form will be subject to the following routine uses:

1. The information on this form will be treated confidentially to the extent allowed under the Freedom of Information Act (5 U.S.C. 552) and the Privacy Act (5 U.S.C. 552a). Records from this system of records may be disclosed to the Department of Justice to determine whether the Freedom of Information Act requires disclosure of these records.
2. A record from this system of records may be disclosed, as a routine use, in the course of presenting evidence to a court, magistrate, or administrative tribunal, including disclosures to opposing counsel in the course of settlement negotiations.
3. A record in this system of records may be disclosed, as a routine use, to a Member of Congress submitting a request involving an individual, to whom the record pertains, when the individual has requested assistance from the Member with respect to the subject matter of the record.
4. A record in this system of records may be disclosed, as a routine use, to a contractor of the Agency having need for the information in order to perform a contract. Recipients of information shall be required to comply with the requirements of the Privacy Act of 1974, as amended, pursuant to 5 U.S.C. 552a(m).
5. A record related to an International Application filed under the Patent Cooperation Treaty in this system of records may be disclosed, as a routine use, to the International Bureau of the World Intellectual Property Organization, pursuant to the Patent Cooperation Treaty.
6. A record in this system of records may be disclosed, as a routine use, to another federal agency for purposes of National Security review (35 U.S.C. 181) and for review pursuant to the Atomic Energy Act (42 U.S.C. 218(c)).
7. A record from this system of records may be disclosed, as a routine use, to the Administrator, General Services, or his/her designee, during an inspection of records conducted by GSA as part of that agency's responsibility to recommend improvements in records management practices and programs, under authority of 44 U.S.C. 2904 and 2906. Such disclosure shall be made in accordance with the GSA regulations governing inspection of records for this purpose, and any other relevant (i.e., GSA or Commerce) directive. Such disclosure shall not be used to make determinations about individuals.
8. A record from this system of records may be disclosed, as a routine use, to the public after either publication of the application pursuant to 35 U.S.C. 122(b) or issuance of a patent pursuant to 35 U.S.C. 151. Further, a record may be disclosed, subject to the limitations of 37 CFR 1.14, as a routine use, to the public if the record was filed in an application which became abandoned or in which the proceedings were terminated and which application is referenced by either a published application, an application open to public inspections or an issued patent.
9. A record from this system of records may be disclosed, as a routine use, to a Federal, State, or local law enforcement agency, if the USPTO becomes aware of a violation or potential violation of law or regulation.

EWS-003761



NOTICE OF ALLOWANCE AND FEE(S) DUE

70984 7590 05/31/2013
The STR3EM Team
2885 Sanford Ave SW #13208
Grandville, MI 49418

Table with 2 columns: EXAMINER (TRAN, TRI MINH), ART UNIT (2494), PAPER NUMBER (7081)

DATE MAILED: 05/31/2013

Table with 5 columns: APPLICATION NO. (13/740,086), FILING DATE (01/11/2013), FIRST NAMED INVENTOR (William Grecia), ATTORNEY DOCKET NO., CONFIRMATION NO. (7081)

TITLE OF INVENTION: PERSONALIZED DIGITAL MEDIA ACCESS SYSTEM - PDMAS PART II

Table with 7 columns: APPLN. TYPE (nonprovisional), ENTITY STATUS (SMALL), ISSUE FEE DUE (\$890), PUBLICATION FEE DUE (\$0), PREV. PAID ISSUE FEE (\$0), TOTAL FEE(S) DUE (\$890), DATE DUE (09/03/2013)

THE APPLICATION IDENTIFIED ABOVE HAS BEEN EXAMINED AND IS ALLOWED FOR ISSUANCE AS A PATENT. PROSECUTION ON THE MERITS IS CLOSED. THIS NOTICE OF ALLOWANCE IS NOT A GRANT OF PATENT RIGHTS. THIS APPLICATION IS SUBJECT TO WITHDRAWAL FROM ISSUE AT THE INITIATIVE OF THE OFFICE OR UPON PETITION BY THE APPLICANT. SEE 37 CFR 1.313 AND MPEP 1308.

THE ISSUE FEE AND PUBLICATION FEE (IF REQUIRED) MUST BE PAID WITHIN THREE MONTHS FROM THE MAILING DATE OF THIS NOTICE OR THIS APPLICATION SHALL BE REGARDED AS ABANDONED. THIS STATUTORY PERIOD CANNOT BE EXTENDED. SEE 35 U.S.C. 151. THE ISSUE FEE DUE INDICATED ABOVE DOES NOT REFLECT A CREDIT FOR ANY PREVIOUSLY PAID ISSUE FEE IN THIS APPLICATION. IF AN ISSUE FEE HAS PREVIOUSLY BEEN PAID IN THIS APPLICATION (AS SHOWN ABOVE), THE RETURN OF PART B OF THIS FORM WILL BE CONSIDERED A REQUEST TO REAPPLY THE PREVIOUSLY PAID ISSUE FEE TOWARD THE ISSUE FEE NOW DUE.

HOW TO REPLY TO THIS NOTICE:

I. Review the ENTITY STATUS shown above. If the ENTITY STATUS is shown as SMALL or MICRO, verify whether entitlement to that entity status still applies. If the ENTITY STATUS is the same as shown above, pay the TOTAL FEE(S) DUE shown above. If the ENTITY STATUS is changed from that shown above, on PART B - FEE(S) TRANSMITTAL, complete section number 5 titled "Change in Entity Status (from status indicated above)". For purposes of this notice, small entity fees are 1/2 the amount of undiscounted fees, and micro entity fees are 1/2 the amount of small entity fees.

II. PART B - FEE(S) TRANSMITTAL, or its equivalent, must be completed and returned to the United States Patent and Trademark Office (USPTO) with your ISSUE FEE and PUBLICATION FEE (if required). If you are charging the fee(s) to your deposit account, section "4b" of Part B - Fee(s) Transmittal should be completed and an extra copy of the form should be submitted. If an equivalent of Part B is filed, a request to reapply a previously paid issue fee must be clearly made, and delays in processing may occur due to the difficulty in recognizing the paper as an equivalent of Part B.

III. All communications regarding this application must give the application number. Please direct all communications prior to issuance to Mail Stop ISSUE FEE unless advised to the contrary.

IMPORTANT REMINDER: Utility patents issuing on applications filed on or after Dec. 12, 1980 may require payment of maintenance fees. It is patentee's responsibility to ensure timely payment of maintenance fees when due.

**PART B - FEE(S) TRANSMITTAL**

**Complete and send this form, together with applicable fee(s), to: Mail Mail Stop ISSUE FEE  
 Commissioner for Patents  
 P.O. Box 1450  
 Alexandria, Virginia 22313-1450  
 or Fax (571)-273-2885**

**INSTRUCTIONS:** This form should be used for transmitting the ISSUE FEE and PUBLICATION FEE (if required). Blocks 1 through 5 should be completed where appropriate. All further correspondence including the Patent, advance orders and notification of maintenance fees will be mailed to the current correspondence address as indicated unless corrected below or directed otherwise in Block 1, by (a) specifying a new correspondence address; and/or (b) indicating a separate "FEE ADDRESS" for maintenance fee notifications.

CURRENT CORRESPONDENCE ADDRESS (Note: Use Block 1 for any change of address)

Note: A certificate of mailing can only be used for domestic mailings of the Fee(s) Transmittal. This certificate cannot be used for any other accompanying papers. Each additional paper, such as an assignment or formal drawing, must have its own certificate of mailing or transmission.

70984                      7590                      05/31/2013  
**The STR3EM Team**  
 2885 Sanford Ave SW #13208  
 Grandville, MI 49418

**Certificate of Mailing or Transmission**

I hereby certify that this Fee(s) Transmittal is being deposited with the United States Postal Service with sufficient postage for first class mail in an envelope addressed to the Mail Stop ISSUE FEE address above, or being facsimile transmitted to the USPTO (571) 273-2885, on the date indicated below.

(Depositor's name)
(Signature)
(Date)

APPLICATION NO.	FILING DATE	FIRST NAMED INVENTOR	ATTORNEY DOCKET NO.	CONFIRMATION NO.
13/740,086	01/11/2013	William Grecia		7081

TITLE OF INVENTION: PERSONALIZED DIGITAL MEDIA ACCESS SYSTEM - PDMAS PART II

APPLN. TYPE	ENTITY STATUS	ISSUE FEE DUE	PUBLICATION FEE DUE	PREV. PAID ISSUE FEE	TOTAL FEE(S) DUE	DATE DUE
nonprovisional	SMALL	\$890	\$0	\$0	\$890	09/03/2013

EXAMINER	ART UNIT	CLASS-SUBCLASS
TRAN, TRI MINH	2494	726-010000

<p>1. Change of correspondence address or indication of "Fee Address" (37 CFR 1.363).</p> <p><input type="checkbox"/> Change of correspondence address (or Change of Correspondence Address form PTO/SB/122) attached.</p> <p><input type="checkbox"/> "Fee Address" indication (or "Fee Address" Indication form PTO/SB/47; Rev 03-02 or more recent) attached. <b>Use of a Customer Number is required.</b></p>	<p>2. For printing on the patent front page, list</p> <p>(1) the names of up to 3 registered patent attorneys or agents OR, alternatively, 1 _____</p> <p>(2) the name of a single firm (having as a member a registered attorney or agent) and the names of up to 2 registered patent attorneys or agents. If no name is listed, no name will be printed. 2 _____</p> <p>3 _____</p>
---	---

3. ASSIGNEE NAME AND RESIDENCE DATA TO BE PRINTED ON THE PATENT (print or type)

PLEASE NOTE: Unless an assignee is identified below, no assignee data will appear on the patent. If an assignee is identified below, the document has been filed for recordation as set forth in 37 CFR 3.11. Completion of this form is NOT a substitute for filing an assignment.

(A) NAME OF ASSIGNEE \_\_\_\_\_ (B) RESIDENCE: (CITY and STATE OR COUNTRY) \_\_\_\_\_

Please check the appropriate assignee category or categories (will not be printed on the patent) :  Individual  Corporation or other private group entity  Government

<p>4a. The following fee(s) are submitted:</p> <p><input type="checkbox"/> Issue Fee</p> <p><input type="checkbox"/> Publication Fee (No small entity discount permitted)</p> <p><input type="checkbox"/> Advance Order - # of Copies _____</p>	<p>4b. Payment of Fee(s): (Please first reapply any previously paid issue fee shown above)</p> <p><input type="checkbox"/> A check is enclosed.</p> <p><input type="checkbox"/> Payment by credit card. Form PTO-2038 is attached.</p> <p><input type="checkbox"/> The Director is hereby authorized to charge the required fee(s), any deficiency, or credit any overpayment, to Deposit Account Number _____ (enclose an extra copy of this form).</p>
---	--

5. **Change in Entity Status** (from status indicated above)

- Applicant certifying micro entity status. See 37 CFR 1.29
- Applicant asserting small entity status. See 37 CFR 1.27
- Applicant changing to regular undiscounted fee status.

NOTE: Absent a valid certification of Micro Entity Status (see form PTO/SB/15A and 15B), issue fee payment in the micro entity amount will not be accepted at the risk of application abandonment.

NOTE: If the application was previously under micro entity status, checking this box will be taken to be a notification of loss of entitlement to micro entity status.

NOTE: Checking this box will be taken to be a notification of loss of entitlement to small or micro entity status, as applicable.

---

NOTE: The Issue Fee and Publication Fee (if required) will not be accepted from anyone other than the applicant; a registered attorney or agent; or the assignee or other party in interest as shown by the records of the United States Patent and Trademark Office.

---

Authorized Signature \_\_\_\_\_

Date \_\_\_\_\_

Typed or printed name \_\_\_\_\_

Registration No. \_\_\_\_\_

---

This collection of information is required by 37 CFR 1.311. The information is required to obtain or retain a benefit by the public which is to file (and by the USPTO to process) an application. Confidentiality is governed by 35 U.S.C. 122 and 37 CFR 1.14. This collection is estimated to take 12 minutes to complete, including gathering, preparing, and submitting the completed application form to the USPTO. Time will vary depending upon the individual case. Any comments on the amount of time you require to complete this form and/or suggestions for reducing this burden, should be sent to the Chief Information Officer, U.S. Patent and Trademark Office, U.S. Department of Commerce, P.O. Box 1450, Alexandria, Virginia 22313-1450. DO NOT SEND FEES OR COMPLETED FORMS TO THIS ADDRESS. SEND TO: Commissioner for Patents, P.O. Box 1450, Alexandria, Virginia 22313-1450.

Under the Paperwork Reduction Act of 1995, no persons are required to respond to a collection of information unless it displays a valid OMB control number.

---



UNITED STATES PATENT AND TRADEMARK OFFICE

UNITED STATES DEPARTMENT OF COMMERCE
United States Patent and Trademark Office
Address: COMMISSIONER FOR PATENTS
P.O. Box 1450
Alexandria, Virginia 22313-1450
www.uspto.gov

Table with 5 columns: APPLICATION NO., FILING DATE, FIRST NAMED INVENTOR, ATTORNEY DOCKET NO., CONFIRMATION NO.
13/740,086 01/11/2013 William Grecia 7081

70984 7590 05/31/2013
The STR3EM Team
2885 Sanford Ave SW #13208
Grandville, MI 49418

EXAMINER

TRAN, TRI MINH

ART UNIT PAPER NUMBER

2494

DATE MAILED: 05/31/2013

Determination of Patent Term Adjustment under 35 U.S.C. 154 (b)
(application filed on or after May 29, 2000)

The Patent Term Adjustment to date is 0 day(s). If the issue fee is paid on the date that is three months after the mailing date of this notice and the patent issues on the Tuesday before the date that is 28 weeks (six and a half months) after the mailing date of this notice, the Patent Term Adjustment will be 0 day(s).

If a Continued Prosecution Application (CPA) was filed in the above-identified application, the filing date that determines Patent Term Adjustment is the filing date of the most recent CPA.

Applicant will be able to obtain more detailed information by accessing the Patent Application Information Retrieval (PAIR) WEB site (http://pair.uspto.gov).

Any questions regarding the Patent Term Extension or Adjustment determination should be directed to the Office of Patent Legal Administration at (571)-272-7702. Questions relating to issue and publication fee payments should be directed to the Customer Service Center of the Office of Patent Publication at 1-(888)-786-0101 or (571)-272-4200.

## Privacy Act Statement

**The Privacy Act of 1974 (P.L. 93-579)** requires that you be given certain information in connection with your submission of the attached form related to a patent application or patent. Accordingly, pursuant to the requirements of the Act, please be advised that: (1) the general authority for the collection of this information is 35 U.S.C. 2(b)(2); (2) furnishing of the information solicited is voluntary; and (3) the principal purpose for which the information is used by the U.S. Patent and Trademark Office is to process and/or examine your submission related to a patent application or patent. If you do not furnish the requested information, the U.S. Patent and Trademark Office may not be able to process and/or examine your submission, which may result in termination of proceedings or abandonment of the application or expiration of the patent.

The information provided by you in this form will be subject to the following routine uses:

1. The information on this form will be treated confidentially to the extent allowed under the Freedom of Information Act (5 U.S.C. 552) and the Privacy Act (5 U.S.C. 552a). Records from this system of records may be disclosed to the Department of Justice to determine whether disclosure of these records is required by the Freedom of Information Act.
2. A record from this system of records may be disclosed, as a routine use, in the course of presenting evidence to a court, magistrate, or administrative tribunal, including disclosures to opposing counsel in the course of settlement negotiations.
3. A record in this system of records may be disclosed, as a routine use, to a Member of Congress submitting a request involving an individual, to whom the record pertains, when the individual has requested assistance from the Member with respect to the subject matter of the record.
4. A record in this system of records may be disclosed, as a routine use, to a contractor of the Agency having need for the information in order to perform a contract. Recipients of information shall be required to comply with the requirements of the Privacy Act of 1974, as amended, pursuant to 5 U.S.C. 552a(m).
5. A record related to an International Application filed under the Patent Cooperation Treaty in this system of records may be disclosed, as a routine use, to the International Bureau of the World Intellectual Property Organization, pursuant to the Patent Cooperation Treaty.
6. A record in this system of records may be disclosed, as a routine use, to another federal agency for purposes of National Security review (35 U.S.C. 181) and for review pursuant to the Atomic Energy Act (42 U.S.C. 218(c)).
7. A record from this system of records may be disclosed, as a routine use, to the Administrator, General Services, or his/her designee, during an inspection of records conducted by GSA as part of that agency's responsibility to recommend improvements in records management practices and programs, under authority of 44 U.S.C. 2904 and 2906. Such disclosure shall be made in accordance with the GSA regulations governing inspection of records for this purpose, and any other relevant (i.e., GSA or Commerce) directive. Such disclosure shall not be used to make determinations about individuals.
8. A record from this system of records may be disclosed, as a routine use, to the public after either publication of the application pursuant to 35 U.S.C. 122(b) or issuance of a patent pursuant to 35 U.S.C. 151. Further, a record may be disclosed, subject to the limitations of 37 CFR 1.14, as a routine use, to the public if the record was filed in an application which became abandoned or in which the proceedings were terminated and which application is referenced by either a published application, an application open to public inspection or an issued patent.
9. A record from this system of records may be disclosed, as a routine use, to a Federal, State, or local law enforcement agency, if the USPTO becomes aware of a violation or potential violation of law or regulation.



<b>Notice of Allowability</b>	<b>Application No.</b> 13/740,086	<b>Applicant(s)</b> GRECIA, WILLIAM	
	<b>Examiner</b> TRI TRAN	<b>Art Unit</b> 2494	<b>AIA (First Inventor to File) Status</b> No

**-- The MAILING DATE of this communication appears on the cover sheet with the correspondence address--**

All claims being allowable, PROSECUTION ON THE MERITS IS (OR REMAINS) CLOSED in this application. If not included herewith (or previously mailed), a Notice of Allowance (PTOL-85) or other appropriate communication will be mailed in due course. **THIS NOTICE OF ALLOWABILITY IS NOT A GRANT OF PATENT RIGHTS.** This application is subject to withdrawal from issue at the initiative of the Office or upon petition by the applicant. See 37 CFR 1.313 and MPEP 1308.

1.  This communication is responsive to 16 February 2013.  
 A declaration(s)/affidavit(s) under **37 CFR 1.130(b)** was/were filed on \_\_\_\_\_.
2.  An election was made by the applicant in response to a restriction requirement set forth during the interview on \_\_\_\_\_; the restriction requirement and election have been incorporated into this action.
3.  The allowed claim(s) is/are 1-30. As a result of the allowed claim(s), you may be eligible to benefit from the **Patent Prosecution Highway** program at a participating intellectual property office for the corresponding application. For more information, please see [http://www.uspto.gov/patents/init\\_events/oph/index.jsp](http://www.uspto.gov/patents/init_events/oph/index.jsp) or send an inquiry to [PPHfeedback@uspto.gov](mailto:PPHfeedback@uspto.gov).
4.  Acknowledgment is made of a claim for foreign priority under 35 U.S.C. § 119(a)-(d) or (f).

**Certified copies:**

- a)  All    b)  Some    \*c)  None of the:
1.  Certified copies of the priority documents have been received.
  2.  Certified copies of the priority documents have been received in Application No. \_\_\_\_\_.
  3.  Copies of the certified copies of the priority documents have been received in this national stage application from the International Bureau (PCT Rule 17.2(a)).

\* Certified copies not received: \_\_\_\_\_.

**Interim copies:**

- a)  All    b)  Some    c)  None of the: Interim copies of the priority documents have been received.

Applicant has THREE MONTHS FROM THE "MAILING DATE" of this communication to file a reply complying with the requirements noted below. Failure to timely comply will result in ABANDONMENT of this application.

**THIS THREE-MONTH PERIOD IS NOT EXTENDABLE.**

5.  CORRECTED DRAWINGS ( as "replacement sheets") must be submitted.  
 including changes required by the attached Examiner's Amendment / Comment or in the Office action of Paper No./Mail Date \_\_\_\_\_.  
**Identifying indicia such as the application number (see 37 CFR 1.84(c)) should be written on the drawings in the front (not the back) of each sheet. Replacement sheet(s) should be labeled as such in the header according to 37 CFR 1.121(d).**
6.  DEPOSIT OF and/or INFORMATION about the deposit of BIOLOGICAL MATERIAL must be submitted. Note the attached Examiner's comment regarding REQUIREMENT FOR THE DEPOSIT OF BIOLOGICAL MATERIAL.

**Attachment(s)**

- |  |  |
|--|--|
| 1. <input checked="" type="checkbox"/> Notice of References Cited (PTO-892)  | 5. <input checked="" type="checkbox"/> Examiner's Amendment/Comment                  |
| 2. <input checked="" type="checkbox"/> Information Disclosure Statements (PTO/SB/08),<br>Paper No./Mail Date _____ | 6. <input checked="" type="checkbox"/> Examiner's Statement of Reasons for Allowance |
| 3. <input type="checkbox"/> Examiner's Comment Regarding Requirement for Deposit<br>of Biological Material         | 7. <input type="checkbox"/> Other _____.   |
| 4. <input type="checkbox"/> Interview Summary (PTO-413),<br>Paper No./Mail Date _____.                             |  |

/TRI TRAN/  
Examiner, Art Unit 2494

/Jung Kim/  
Supervisory Patent Examiner, Art Unit 2494

### DETAILED ACTION

Claims 1-30 are allowed.

This communications is in response to the application filed on February 16 2013.

### EXAMINER'S AMENDMENT

1. An examiner's amendment to the record appears below. Should the changes and/or additions be unacceptable to applicant, an amendment may be filed as provided by 37 CFR 1.312. To ensure consideration of such an amendment, it MUST be submitted no later than the payment of the issue fee.

Authorization for this examiner's amendment was given in a telephone interviews and emails with the Applicant/Inventor William Grecia on May 13<sup>th</sup>, 20<sup>th</sup>, and 22<sup>th</sup> 2013.

### Amended Claims

1. *(Currently amended) A method for authorizing ~~monitoring~~ access to digital content ~~an internet-connected data source~~ using a cloud system, the cloud system comprising connected modules in operation as one or more of a cloud computing or a cloud storage in connection with devices and users, wherein the digital content ~~internet-connected data source~~ comprises one or more of a machine, video, audio, container, format, document, credit card information, personal information, textual information, image, advertisement, logo, tag, message, URL, video game, software, downloadable program, content provider, service provider, or other computer based apparatus in which ~~processed data is facilitated, the data being one of encrypted or not encrypted, the~~*

Art Unit: 2494

*method facilitating access rights between a plurality of data processing devices, the method comprising:*

*receiving the digital content ~~internet-connected data source~~ access request from at least one communications console of the plurality of data processing devices, the access request being a read or write request of metadata of the digital content ~~internet-connected data source~~, wherein the read or write request of metadata is performed in connection with a combination of at least one device and the cloud system, the request comprising a verification token provided by a first user corresponding to the digital content ~~internet-connected data source~~, wherein the verification token is one or more of a password, e-mail address, payment system, credit card, authorize ready device, rights token, or one or more redeemable instruments of trade;*

*authenticating the verification token;*

*establishing a connection with the at least one communications console, wherein the communications console is a combination of a graphic user interface (GUI) and an Applications Programmable Interface (API) wherein the API is obtained from a verified web service, the web service capable of facilitating a two way data exchange to complete a verification process wherein the data exchange session comprises at least one reference;*

*requesting at least one identification reference from the at least one communications console, wherein the identification reference comprises one or more of a verified web service account identifier, letter, number, rights token, e-mail, password, access time, serial number, address, manufacturer identification, checksum, ~~file, circuit,~~ operating system version, browser version, credential, cookie, or key, ~~or ID;~~*

*receiving the at least one reference from the at least one communications console; and*

*writing at least one of the verification token or the reference into the metadata.*

*2. (Currently amended) The method according to claim 1, wherein the access request being a request from the first user through a data processing device of the plurality of data processing devices; or wherein the access request being a request from one or more secondary users in network to the first user; wherein said secondary users are validated by a membership web service.*

*3. (Original) The method according to claim 2, wherein the metadata comprises one or more of a software or contents of a web page.*

*4. (Currently amended) The method according to claim 3, wherein the verification token represents verification from a provider of the token to grant access rights to the first user.*

*5. (Currently amended) The method according to claim ~~3~~[4], wherein the digital content ~~internet connected data source~~ is shared among one or more users according to a membership status.*

*6. (Currently amended) The method according to claim 5, wherein the one or more users are a network of recognized human beings using machines or recognized automated computerized mechanisms programmed by human beings, the recognition of said the one or more users being validated by the membership status of the membership web service.*

*7. (Currently amended) The method according to claim 6, wherein the digital content ~~internet connected data source~~ access request is from a user using a computer or a phone hosting an operating system running an application.*

Art Unit: 2494

8. (Currently amended) The method of claim 7, wherein ~~said~~ the verification token comprises at least one token selected from the group consisting of a purchase permission, a rental permission, or a membership permission;

~~wherein said~~ the at least one of purchase permission, rental permission, or membership permission is represented by one or more of a letter, number, combination of letters and numbers, rights token, successful payment reference, phrase, name, membership credentials, image, logo, tag, service name, authorization, list, interface button, downloadable program, or an instrument of trade.

9. (Currently amended) A system for authorizing ~~monitoring~~ access to digital content ~~an internet-connected data source~~ using a worldwide cloud system infrastructure, the worldwide cloud system infrastructure comprising connected modules in operation as computing and storage, the computing and storage comprising a server, a database, devices and users, wherein the digital content ~~internet-connected data source~~ comprises ~~one or more of a machine, video, audio, container, format, document, credit card information, personal information, textual information, image, advertisement, logo, tag, message, URL, video game, software, downloadable program, content provider, service provider, or other computer based apparatus in which processed data is facilitated, the data being one of encrypted or not encrypted, the system facilitating access rights between a plurality of data processing devices, the system working as a front-end agent for access rights authentication between the plurality of data processing devices, the system further comprising:~~

~~a first receipt module, the first receipt module receiving the~~ digital content ~~internet-connected data source~~ access request from at least one communications console of the plurality of data processing devices, the access request being a read or write request of metadata of the digital content ~~internet-connected data source~~, wherein the read or write request of metadata is performed in connection with a combination of a device, the server, the database and the cloud system, the metadata further comprises

Art Unit: 2494

*one or more of a software or contents of a web page, the request comprising a verification token provided by a user corresponding to the digital content internet ~~connected data source~~, wherein the verification token is one or more of a password, e-mail address, payment system, credit card, authorize ready device, rights token, or one or more redeemable instruments of trade;*

*an authentication module, the authentication module authenticating the verification token;*

*a connection module, the connection module establishing a connection with the at least one communications console, wherein the communications console is a combination of a graphic user interface (GUI) and an Applications Programmable Interface (API) wherein the API is obtained from a verified web service, the web service capable of facilitating a two way data exchange to complete a verification process wherein the data exchange session comprises at least one reference;*

*a request module, the request module requesting at least one identification reference from the at least one communications console, wherein the identification reference comprises one or more of a verified web service account identifier, letter, number, rights token, e-mail, password, access time, serial number, address, manufacturer identification, checksum, ~~file, circuit,~~ operating system version, browser version, credential, cookie, or key, ~~or ID;~~*

*a secondary receipt module, the secondary receipt module receiving the at least one reference from the at least one communications console; and*

*a branding module, the branding module writing at least one of the verification token or the reference into the metadata.*

Art Unit: 2494

10. (original) The system of claim 9, wherein the verification token comprises at least one token selected from the group consisting of a purchase permission, a rental permission, or a membership permission;

wherein the at least one of purchase permission, rental permission, or membership permission is represented by one or more of a tag, letter, number, combination of letters and numbers, rights token, successful payment reference, phrase, name, membership credentials, image, logo, service name, authorization, list, interface button, downloadable program, or an instrument of trade.

11. (Currently amended) ~~An operating system software program for use with at least one data processing device of a plurality of data processing devices, the data processing device hosting at least one operating system software version of a plurality of operating system software versions, the data processing device comprising a non-transitory usable medium storing the operating system software~~ A non-transitory computer medium comprising a program code, the program code being a part of ~~the an~~ operating system software or downloaded in sections from a web server, the operating system software program coupled with a user executing a method for authorizing access to digital content ~~monitoring access to a non-public internet connected asset using a cloud system, the cloud system comprising internet connected modules comprising storage and computing, the method facilitating a data exchange session between a combination of the a user in operation of the data processing device and the cloud system, the data exchange session establishing an access permission for the internet connected asset, wherein the internet connected asset comprises one or more of a machine, video, audio, container, format, document, credit card information, personal information, textual information, image, advertisement, logo, tag, message, URL, video game, software, downloadable program, content provider, service provider, or other computer based apparatus in which processed data is facilitated, the operating system software program coupled with the user performing~~ wherein the

Art Unit: 2494

method-program code, when executed in a processor for facilitating access rights between a plurality of data processing devices, performs the following steps of:

receiving the digital content internet-connected-asset access request from at least one communications console of the plurality of data processing devices, the access request being a read or write request of metadata of the digital content internet-connected-asset, wherein the read or write request of metadata is performed in connection with a combination of the operating system software program and the cloud system, the request comprising a verification token provided by the user corresponding to the digital content internet-connected-asset, wherein the verification token is one or more of a password, e-mail address, payment system, credit card, authorize ready device, rights token, key, file, or one or more redeemable instruments of trade;

authenticating the verification token;

establishing a connection with the at least one communications console, wherein the communications console is a combination of a graphic user interface (GUI) and an Applications Programmable Interface (API) wherein the API is obtained from a verified web service, the web service capable of facilitating a two way data exchange to complete a verification process wherein the data exchange session comprises at least one reference;

requesting at least one identification reference from the at least one communications console, wherein the identification reference is one or more of a verified web service account identifier, letter, number, rights token, e-mail, password, access time, serial number, address, manufacturer identification, checksum, ~~file, circuit,~~ operating system version, browser version, credential, cookie, or key, or ID;

receiving the at least one reference from the at least one communications console; and



Art Unit: 2494

*writing at least one of the verification token or the reference into the metadata.*

12. (Currently amended) *The ~~operating system software program~~ non-transitory computer medium according to claim 11, wherein the access request is a request from the user providing a credential to a membership web service through a data processing device of the plurality of data processing devices, the user being a human user establishing a permission to the digital content ~~internet connected asset~~.*

13. (Currently amended) *The ~~operating system software program~~ non-transitory computer medium of claim 12, wherein the verification token comprises at least one of a purchase permission, a rental permission, or a membership permission;*

*wherein the at least one of purchase permission, rental permission, or membership permission is represented by one or more of a tag, letter, number, combination of letters and numbers, successful payment reference, phrase, name, membership credential, image, logo, service name, authorization, list, key, file, interface button, downloadable program, or an instrument of trade.*

14. (Currently amended) *The ~~operating system software program~~ non-transitory computer medium according to claim 13, wherein the verification token represents verification from a provider that a product was acquired.*

15. (Currently amended) *The ~~operating system software program~~ non-transitory computer medium according to claim 13, wherein the digital content ~~internet connected asset~~ is accessed according to a membership status.*

16. (Currently amended) *The ~~operating system software program~~ non-transitory computer medium according to claim 15, wherein the membership status is connected to an application programmable interface.*

Art Unit: 2494

17. (Currently amended) ~~The operating system software program~~ non-transitory computer medium according to claim 15, wherein a remote control operation exist.

18. (Currently amended) ~~The operating system software program~~ non-transitory computer medium according to claim 16, wherein the application programmable interface is connected to a graphic user interface.

19. (Currently amended) ~~The operating system software program~~ non-transitory computer medium according to claim 17, wherein the digital content ~~internet connected asset~~ is shared with one or more secondary users.

20. (Currently amended) ~~The operating system software program~~ non-transitory computer medium according to claim 19, wherein the digital content ~~internet connected asset~~ is shared with the secondary user according to a period of time.

21. (Currently amended) An computer product comprising a memory, a CPU, a communications console and a non-transitory computer usable medium, the computer usable medium having an operating system stored therein, the computer product further comprising a customization module, the computer product authorizing ~~coupled with a user executing a method for monitoring access to digital content~~ a data source, wherein the digital content data source is one of an application, a video, or a video game, ~~or a software, wherein the data source is one of a local or an internet connected~~, wherein the digital content data source is one of encrypted or not encrypted, the computer product ~~coupled with the user performing~~ configured to perform the ~~method~~ steps of:

receiving the digital content ~~data source~~ access request from the communications console, the access request being a read or write request of metadata of the digital content ~~data source~~, the metadata of the digital content ~~data source~~ being

Art Unit: 2494

*one or more of a database or storage in connection to the computer product, the request comprising a verification token corresponding to the digital content data source, the verification token is handled by the user as a redeemable instrument, wherein the verification token comprises at least one of a purchase permission, a rental permission, or a membership permission, wherein the at least one of purchase permission, rental permission, or membership permission being represented by one or more of a tag, a letter, a number, a combination of letters and numbers, a successful payment, a rights token, a phrase, a name, a membership credential, an image, a logo, a service name, an authorization, a list, an interface button, a downloadable program, or the redeemable instrument;*

*authenticating the verification token;*

*establishing a connection with the communications console, wherein the communications console ~~comprises a data exchange session, wherein the data exchange session comprises at least one reference~~ is a combination of a graphic user interface (GUI) and an Applications Programmable Interface (API) wherein the API is obtained from a verified web service, the web service capable of facilitating a two way data exchange to complete a verification process wherein the data exchange session comprises at least one reference;*

*requesting at least one identification reference from the at least one communications console, wherein the identification reference comprises one or more of a verified web service account identifier, letter, number, rights token, e-mail, password, access time, serial number, address, manufacturer identification, checksum, ~~file, circuit,~~ operating system version, browser version, credential, cookie, or key, or ID;*

*receiving the at least one reference from the communications console; and*

*writing at least one of the verification token or the reference into the said metadata.*

Art Unit: 2494

22. (Currently amended) The computer product according to claim 21, wherein the access request is a request from a first user, the first user is a human user in operation of the computer product and establishes first access to the digital content ~~data source~~;  
or

wherein the access request is a request from a secondary user, the secondary user is a human user in operation of the computer product and establishes secondary access to the same digital content ~~data source~~ as first established for access by the first user.

23. (Original) The computer product according to claim 21, wherein the customization module customizes the tag.

24. (Original) The computer product according to claim 21, wherein the customization module customizes a user access panel.

25. (Currently amended) The computer product according to claim 22, wherein the digital content ~~a data source~~ is monitored for access using a worldwide cloud system infrastructure, the worldwide cloud system infrastructure comprising internet connected modules in operation as computing and storage services in connection to the computer product.

26. (Original) The computer product according to claim 22, wherein the verification token is connected to a royalty scheme.

27. (Original) The computer product according to claim 25, wherein the access is allowed according to a permission facilitated by a web service working as a front-end agent to the worldwide cloud system infrastructure.

Art Unit: 2494

*28. (Original) The computer product according to claim 25, wherein the computer product is a device of a plurality of devices in a network of the user.*

*29. (Original) The computer product according to claim 28, wherein the device is a computer or a phone.*

*30. (Original) The computer product according to claim 29, wherein a remote control operation exist.*

### **Allowable Subject Matter**

1. Claims 1-30 are allowed.
2. The following is an examiner's statement of reasons for allowance:

The following prior art are the closest materials to the subject matter of claim 1 and similarly claimed in claims 9, 11, and 21:

Baiya et al. PG Pub 20110288946 - Method and System of Managing Digital Multimedia Content (herein after Baiya). Baiya discloses a process of "the management of digital multimedia content comprises a computer-implemented digital multimedia content management system comprising the following computer executable components: an upload component that uploads digital media content ...a catalog component that allows a first user to tag the digital media content with one or more attributes... a grouping component that groups the digital media content according to the one or more attributes; a licensing component that attaches one or more keys to the digital media content; a security component that encrypts the digital media content; and a sharing component that allows one or more second users to access the digital media

Art Unit: 2494

content (Fig. 3-4 and paragraphs [0008]). The user can access the copyrighted digital media for access by using an interface called Content Manager (paragraph [0022]) wherein the Content Manager is using Application Program Interface protocol for access control authentication and authorization information (paragraph [0064]).

Chris Wimmer US Patent 7526650 - Personal Identifiers for Protecting Video Content (herein after Wimmer), Wimmer discloses "techniques for branding video content with an end user's personal identity information ("personal identifier," "mark," or "brand") as a deterrent against unauthorized redistribution of the video content by the user. A "user" is a person or personal entity that receives the video content to be protected or the owner of a client device that receives the video content to be protected" (column 2, lines 9-15). The method aims "to prevent redistribution of content before it happens rather than provide a tool for tracking down a user after an unauthorized redistribution of video content has already been made" (Fig. 1-5, 7 and column 2, line 25-29).

However, neither Baiya nor Wimmer in singly or in combination implicitly or explicitly suggests *the method facilitating access rights between a plurality of data processing devices* with the steps of:

*establishing a connection with the at least one communications console, wherein the communications console is a combination of a graphic user interface (GUI) and an Applications Programmable Interface (API) wherein the API is obtained from a verified web service, the web service capable of facilitating a two way data exchange to*

Art Unit: 2494

complete a verification process wherein the data exchange session comprises at least one reference;

*requesting at least one identification reference from the at least one communications console, wherein the identification reference comprises one or more of a verified web service account identifier, letter, number, rights token, e-mail, password, access time, serial number, address, manufacturer identification, checksum, ~~file, circuit,~~ operating system version, browser version, credential, cookie, or key, ~~or ID~~;*

Since no prior art teaches or suggests any system with the above allowable limitations, claim 1 and its dependent claims are allowed. Similarly, claims 9, 11, and 21, which claim substantially similar limitations, are allowed for the same reasons.

Any comments considered necessary by applicant must be submitted no later than the payment of the issue fee and, to avoid processing delays, should preferably accompany the issue fee. Such submissions should be clearly labeled "Comments on Statement of Reasons for Allowance."

### **INQUIRY COMMUNICATION**

Any inquiry concerning this communication or earlier communications from the examiner should be directed to TRI TRAN whose telephone number is (571)270-1994. The examiner can normally be reached on Monday-Friday 9:00 - 5:00 EST.

Art Unit: 2494

If attempts to reach the examiner by telephone are unsuccessful, the examiner's supervisor, Jung (Jay) Kim can be reached on 571-272-3804. The fax phone number for the organization where this application or proceeding is assigned is 571-273-8300.

Information regarding the status of an application may be obtained from the Patent Application Information Retrieval (PAIR) system. Status information for published applications may be obtained from either Private PAIR or Public PAIR. Status information for unpublished applications is available through Private PAIR only. For more information about the PAIR system, see <http://pair-direct.uspto.gov>. Should you have questions on access to the Private PAIR system, contact the Electronic Business Center (EBC) at 866-217-9197 (toll-free). If you would like assistance from a USPTO Customer Service Representative or access to the automated information system, call 800-786-9199 (IN USA OR CANADA) or 571-272-1000.

/TRI TRAN/

Examiner, Art Unit 2494

/Jung Kim/

Supervisory Patent Examiner, Art Unit 2494



<b>Notice of References Cited</b>	Application/Control No. 13/740,086	Applicant(s)/Patent Under Reexamination GRECIA, WILLIAM	
	Examiner TRI TRAN	Art Unit 2494	Page 1 of 1

**U.S. PATENT DOCUMENTS**

*	Document Number Country Code-Number-Kind Code	Date MM-YYYY	Name	Classification
*	A US-2011/0288946	11-2011	Baiya et al.	705/26.1
*	B US-7,526,650	04-2009	Wimmer, Chris	713/176
	C US-			
	D US-			
	E US-			
	F US-			
	G US-			
	H US-			
	I US-			
	J US-			
	K US-			
	L US-			
	M US-			

**FOREIGN PATENT DOCUMENTS**

*	Document Number Country Code-Number-Kind Code	Date MM-YYYY	Country	Name	Classification
	N				
	O				
	P				
	Q				
	R				
	S				
	T				

**NON-PATENT DOCUMENTS**

*	Document Number Country Code-Number-Kind Code	Date MM-YYYY	Country	Name	Classification
	Include as applicable: Author, Title Date, Publisher, Edition or Volume, Pertinent Pages)				
	U				
	V				
	W				
	X				

\*A copy of this reference is not being furnished with this Office action. (See MPEP § 707.05(a).)  
Dates in MM-YYYY format are publication dates. Classifications may be US or foreign.

Receipt date: 01/13/2013

13740086 - GAI: 2494

Doc code: IDS

Pat. Sec. 101-10

Doc description: Information Disclosure Statement (IDS) Filed

Approved for use through 07/31/2012. OMB 0651-0031

U.S. Patent and Trademark Office; U.S. DEPARTMENT OF COMMERCE

Under the Paperwork Reduction Act of 1995, no persons are required to respond to a collection of information unless it contains a valid OMB control number.

<b>INFORMATION DISCLOSURE STATEMENT BY APPLICANT</b> ( Not for submission under 37 CFR 1.99)	Application Number		13740086
	Filing Date		2013-01-11
	First Named Inventor	William Grecia	
	Art Unit	2431x 2494	
	Examiner Name	Not Applicable Tri Tran	
	Attorney Docket Number		

U.S.PATENTS						Remove
Examiner Initial*	Cite No	Patent Number	Kind Code <sup>1</sup>	Issue Date	Name of Patentee or Applicant of cited Document	Pages,Columns,Lines where Relevant Passages or Relevant Figures Appear
/T.T./	1	7254235		2007-08-07	Boudreault et al.	
/T.T./	2	7343014		2008-03-11	Sovio et al.	
/T.T./	3	7526650		2009-04-28	Wimmer, Chris	

If you wish to add additional U.S. Patent citation information please click the Add button.

Add

U.S.PATENT APPLICATION PUBLICATIONS						Remove
Examiner Initial*	Cite No	Publication Number	Kind Code <sup>1</sup>	Publication Date	Name of Patentee or Applicant of cited Document	Pages,Columns,Lines where Relevant Passages or Relevant Figures Appear
/T.T./	1	20110288946		2011-11-24	Baiya et al.	
/T.T./	2	20100100899		2010-04-22	Bradbury et al.	
/T.T./	3	20050065891		2005-03-24	Lee et al.	

<b>INFORMATION DISCLOSURE STATEMENT BY APPLICANT</b> ( Not for submission under 37 CFR 1.99)	Receipt date: 01/13/2013	Application Number	13740086	13740086 - GAU: 2494
	Filing Date	2013-01-11		
	First Named Inventor	William Grecia		
	Art Unit	243kx		
	Examiner Name	Not Applicable		
	Attorney Docket Number			

/T.T./	4	20080010685		2008-01-10	Holtzman et al.	
/T.T./	5	20090083541		2009-03-26	Levine, Scott	

If you wish to add additional U.S. Published Application citation information please click the Add button. **Add**

**FOREIGN PATENT DOCUMENTS**

Remove

Examiner Initial*	Cite No	Foreign Document Number <sup>3</sup>	Country Code <sup>2</sup>	Kind Code <sup>4</sup>	Publication Date	Name of Patentee or Applicant of cited Document	Pages, Columns, Lines where Relevant Passages or Relevant Figures Appear	T <sup>5</sup>
	1							<input type="checkbox"/>

If you wish to add additional Foreign Patent Document citation information please click the Add button. **Add**

**NON-PATENT LITERATURE DOCUMENTS**

Remove

Examiner Initials*	Cite No	Include name of the author (in CAPITAL LETTERS), title of the article (when appropriate), title of the item (book, magazine, journal, serial, symposium, catalog, etc), date, pages(s), volume-issue number(s), publisher, city and/or country where published.	T <sup>5</sup>
/T.T./	1	Copy of co-pending U.S. patent application #13/397,517 document reference: 2013-01-07 Examiner initiated interview summary (PTOL-413B)	<input type="checkbox"/>
/T.T./	2	Copy of co-pending U.S. patent application #13/397,517 document reference: 2012-12-26 Advisory Action (PTOL-303)	<input type="checkbox"/>
/T.T./	3	Copy of co-pending U.S. patent application #13/397,517 document reference: 22012-11-26 Final Rejection	<input type="checkbox"/>
/T.T./	4	Copy of co-pending U.S. patent application #13/397,517 document reference: 2012-11-26 List of references cited by examiner	<input type="checkbox"/>

<b>INFORMATION DISCLOSURE STATEMENT BY APPLICANT</b> ( Not for submission under 37 CFR 1.99)	Receipt date: 01/13/2013	Application Number	13740086	13740086 - GAU: 2494
	Filing Date	2013-01-11		
	First Named Inventor	William Grecia		
	Art Unit	2431		
	Examiner Name	Not Applicable		
	Attorney Docket Number			

/T.T./	5	Copy of co-pending U.S. patent application #13/397,517 document reference: 2012-11-26 List of References cited by applicant and considered by examiner	<input type="checkbox"/>
/T.T./	6	Liu et al. 2004 NPL - A license-sharing scheme in Digital Rights Management	<input type="checkbox"/>
/T.T./	7	Copy of co-pending U.S. patent application #13/397,517 document reference: 2012-11-26 Index of Claims	<input type="checkbox"/>
/T.T./	8	Copy of co-pending U.S. patent application #13/397,517 document reference: 2012-11-26 Examiner's search strategy and results	<input type="checkbox"/>
/T.T./	9	Copy of co-pending U.S. patent application #13/397,517 document reference: 2012-11-26 Non Patent Literature - Baiya et al. Provisional Application 61/307196	<input type="checkbox"/>
/T.T./	10	Copy of co-pending U.S. patent application #13/397,517 document reference: 2012-11-26 Search information including classification, databases and other search related notes	<input type="checkbox"/>
/T.T./	11	Copy of co-pending U.S. patent application #13/397,517 document reference: 2012-05-31 Non-Final Rejection	<input type="checkbox"/>
/T.T./	12	Copy of co-pending U.S. patent application #13/397,517 document reference: 2012-05-31 List of references cited by examiner	<input type="checkbox"/>
/T.T./	13	Copy of co-pending U.S. patent application #13/397,517 document reference: 2012-05-31 Index of Claims	<input type="checkbox"/>
/T.T./	14	Copy of co-pending U.S. patent application #13/397,517 document reference: 2012-05-31 Examiner's search strategy and results	<input type="checkbox"/>
/T.T./	15	Copy of co-pending U.S. patent application #13/397,517 document reference: 2012-05-31 Bibliographic Data Sheet	<input type="checkbox"/>

<b>INFORMATION DISCLOSURE STATEMENT BY APPLICANT</b> ( Not for submission under 37 CFR 1.99)	Application Number		13740086	13740086 - GAU: 2494
	Filing Date		2013-01-11	
	First Named Inventor	William Grecia		
	Art Unit	2431X		
	Examiner Name	Not Applicable		
	Attorney Docket Number			

/T.T./	16	Copy of co-pending U.S. patent application #13/397,517 document reference: 2012-05-31 Search information including classification, databases and other search related notes	<input type="checkbox"/>
/T.T./	17	Copy of co-pending U.S. patent application #13/397,517 document reference: 2012-05-31 List of References cited by applicant and considered by examiner	<input type="checkbox"/>

If you wish to add additional non-patent literature document citation information please click the Add button **Add**

**EXAMINER SIGNATURE**

Examiner Signature	/Tri Tran/ (05/14/2013)	Date Considered	05/14/2013
--------------------	-------------------------	-----------------	------------

\*EXAMINER: Initial if reference considered, whether or not citation is in conformance with MPEP 609. Draw line through a citation if not in conformance and not considered. Include copy of this form with next communication to applicant.

<sup>1</sup> See Kind Codes of USPTO Patent Documents at [www.USPTO.GOV](http://www.USPTO.GOV) or MPEP 901.04. <sup>2</sup> Enter office that issued the document, by the two-letter code (WIPO Standard ST.3). <sup>3</sup> For Japanese patent documents, the indication of the year of the reign of the Emperor must precede the serial number of the patent document. <sup>4</sup> Kind of document by the appropriate symbols as indicated on the document under WIPO Standard ST.16 if possible. <sup>5</sup> Applicant is to place a check mark here if English language translation is attached.

<b>INFORMATION DISCLOSURE STATEMENT BY APPLICANT</b> ( Not for submission under 37 CFR 1.99)	Application Number	13740086	13740086 - GAU: 2494
	Filing Date	2013-01-11	
	First Named Inventor	William Grecia	
	Art Unit	243kx	
	Examiner Name	Not Applicable	
	Attorney Docket Number		

**CERTIFICATION STATEMENT**

Please see 37 CFR 1.97 and 1.98 to make the appropriate selection(s):

That each item of information contained in the information disclosure statement was first cited in any communication from a foreign patent office in a counterpart foreign application not more than three months prior to the filing of the information disclosure statement. See 37 CFR 1.97(e)(1).

**OR**

That no item of information contained in the information disclosure statement was cited in a communication from a foreign patent office in a counterpart foreign application, and, to the knowledge of the person signing the certification after making reasonable inquiry, no item of information contained in the information disclosure statement was known to any individual designated in 37 CFR 1.56(c) more than three months prior to the filing of the information disclosure statement. See 37 CFR 1.97(e)(2).

- See attached certification statement.
- The fee set forth in 37 CFR 1.17 (p) has been submitted herewith.
- A certification statement is not submitted herewith.

**SIGNATURE**

A signature of the applicant or representative is required in accordance with CFR 1.33, 10.18. Please see CFR 1.4(d) for the form of the signature.

Signature	/william grecia/	Date (YYYY-MM-DD)	2013-01-12
Name/Print	William Grecia	Registration Number	70984

This collection of information is required by 37 CFR 1.97 and 1.98. The information is required to obtain or retain a benefit by the public which is to file (and by the USPTO to process) an application. Confidentiality is governed by 35 U.S.C. 122 and 37 CFR 1.14. This collection is estimated to take 1 hour to complete, including gathering, preparing and submitting the completed application form to the USPTO. Time will vary depending upon the individual case. Any comments on the amount of time you require to complete this form and/or suggestions for reducing this burden, should be sent to the Chief Information Officer, U.S. Patent and Trademark Office, U.S. Department of Commerce, P.O. Box 1450, Alexandria, VA 22313-1450. **DO NOT SEND FEES OR COMPLETED FORMS TO THIS ADDRESS. SEND TO: Commissioner for Patents, P.O. Box 1450, Alexandria, VA 22313-1450.**

**Privacy Act Statement**

The Privacy Act of 1974 (P.L. 93-579) requires that you be given certain information in connection with your submission of the attached form related to a patent application or patent. Accordingly, pursuant to the requirements of the Act, please be advised that: (1) the general authority for the collection of this information is 35 U.S.C. 2(b)(2); (2) furnishing of the information solicited is voluntary; and (3) the principal purpose for which the information is used by the U.S. Patent and Trademark Office is to process and/or examine your submission related to a patent application or patent. If you do not furnish the requested information, the U.S. Patent and Trademark Office may not be able to process and/or examine your submission, which may result in termination of proceedings or abandonment of the application or expiration of the patent.

The information provided by you in this form will be subject to the following routine uses:

1. The information on this form will be treated confidentially to the extent allowed under the Freedom of Information Act (5 U.S.C. 552) and the Privacy Act (5 U.S.C. 552a). Records from this system of records may be disclosed to the Department of Justice to determine whether the Freedom of Information Act requires disclosure of these records.
2. A record from this system of records may be disclosed, as a routine use, in the course of presenting evidence to a court, magistrate, or administrative tribunal, including disclosures to opposing counsel in the course of settlement negotiations.
3. A record in this system of records may be disclosed, as a routine use, to a Member of Congress submitting a request involving an individual, to whom the record pertains, when the individual has requested assistance from the Member with respect to the subject matter of the record.
4. A record in this system of records may be disclosed, as a routine use, to a contractor of the Agency having need for the information in order to perform a contract. Recipients of information shall be required to comply with the requirements of the Privacy Act of 1974, as amended, pursuant to 5 U.S.C. 552a(m).
5. A record related to an International Application filed under the Patent Cooperation Treaty in this system of records may be disclosed, as a routine use, to the International Bureau of the World Intellectual Property Organization, pursuant to the Patent Cooperation Treaty.
6. A record in this system of records may be disclosed, as a routine use, to another federal agency for purposes of National Security review (35 U.S.C. 181) and for review pursuant to the Atomic Energy Act (42 U.S.C. 218(c)).
7. A record from this system of records may be disclosed, as a routine use, to the Administrator, General Services, or his/her designee, during an inspection of records conducted by GSA as part of that agency's responsibility to recommend improvements in records management practices and programs, under authority of 44 U.S.C. 2904 and 2906. Such disclosure shall be made in accordance with the GSA regulations governing inspection of records for this purpose, and any other relevant (i.e., GSA or Commerce) directive. Such disclosure shall not be used to make determinations about individuals.
8. A record from this system of records may be disclosed, as a routine use, to the public after either publication of the application pursuant to 35 U.S.C. 122(b) or issuance of a patent pursuant to 35 U.S.C. 151. Further, a record may be disclosed, subject to the limitations of 37 CFR 1.14, as a routine use, to the public if the record was filed in an application which became abandoned or in which the proceedings were terminated and which application is referenced by either a published application, an application open to public inspections or an issued patent.
9. A record from this system of records may be disclosed, as a routine use, to a Federal, State, or local law enforcement agency, if the USPTO becomes aware of a violation or potential violation of law or regulation.



UNITED STATES PATENT AND TRADEMARK OFFICE

UNITED STATES DEPARTMENT OF COMMERCE  
 United States Patent and Trademark Office  
 Address: COMMISSIONER FOR PATENTS  
 P.O. Box 1450  
 Alexandria, Virginia 22313-1450  
 www.uspto.gov

BIB DATA SHEET

CONFIRMATION NO. 7081

<b>SERIAL NUMBER</b> 13/740,086	<b>FILING or 371(c) DATE</b> 01/11/2013 <b>RULE</b>	<b>CLASS</b> 726	<b>GROUP ART UNIT</b> 2494	<b>ATTORNEY DOCKET NO.</b>	
<b>APPLICANTS</b> William Grecia, Brooklyn, NY;					
This is a continuation of 13/397517 which is a continuation of 12/985351 which is a continuation of 12/728218. TT					
<b>** CONTINUING DATA *****</b>					
<b>** FOREIGN APPLICATIONS *****</b>					
<b>** IF REQUIRED, FOREIGN FILING LICENSE GRANTED ** ** SMALL ENTITY **</b> 02/05/2013					
Foreign Priority claimed <input type="checkbox"/> Yes <input checked="" type="checkbox"/> No 35 USC 119(a-d) conditions met <input type="checkbox"/> Yes <input checked="" type="checkbox"/> No Verified and Acknowledged <u>/TRI MINH TRAN/</u> Examiner's Signature	<input type="checkbox"/> Met after Allowance TT Initials	<b>STATE OR COUNTRY</b> NY	<b>SHEETS DRAWINGS</b> 7	<b>TOTAL CLAIMS</b> 30	<b>INDEPENDENT CLAIMS</b> 4
<b>ADDRESS</b> The STR3EM Team 2885 Sanford Ave SW #13208 Grandville, MI 49418 UNITED STATES					
<b>TITLE</b> PERSONALIZED DIGITAL MEDIA ACCESS SYSTEM - PDMAS PART II					
<b>FILING FEE RECEIVED</b> 1268	FEES: Authority has been given in Paper No. _____ to charge/credit DEPOSIT ACCOUNT No. _____ for following:			<input type="checkbox"/> All Fees <input type="checkbox"/> 1.16 Fees (Filing) <input type="checkbox"/> 1.17 Fees (Processing Ext. of time) <input type="checkbox"/> 1.18 Fees (Issue) <input type="checkbox"/> Other _____ <input type="checkbox"/> Credit	



Receipt date: 01/11/2013

13740086 - GAI: 2494

Doc code: IDS

Pat. Sec. 101-10

Doc description: Information Disclosure Statement (IDS) Filed

Approved for use through 07/31/2012. OMB 0651-0031

U.S. Patent and Trademark Office; U.S. DEPARTMENT OF COMMERCE

Under the Paperwork Reduction Act of 1995, no persons are required to respond to a collection of information unless it contains a valid OMB control number.

<b>INFORMATION DISCLOSURE STATEMENT BY APPLICANT</b> ( Not for submission under 37 CFR 1.99)	Application Number		
	Filing Date		2013-01-11
	First Named Inventor	William Grecia	
	Art Unit	2494	
	Examiner Name	Tri Tran	
	Attorney Docket Number		

U.S.PATENTS						Remove
Examiner Initial*	Cite No	Patent Number	Kind Code <sup>1</sup>	Issue Date	Name of Patentee or Applicant of cited Document	Pages,Columns,Lines where Relevant Passages or Relevant Figures Appear
/T.T./	1	8250145		2012-08-21	Zuckerberg; Mark	
/T.T./	2	8280959		2012-10-02	Zuckerberg; Mark	

If you wish to add additional U.S. Patent citation information please click the Add button. Add

U.S.PATENT APPLICATION PUBLICATIONS						Remove
Examiner Initial*	Cite No	Publication Number	Kind Code <sup>1</sup>	Publication Date	Name of Patentee or Applicant of cited Document	Pages,Columns,Lines where Relevant Passages or Relevant Figures Appear
/T.T./	1	20110208695		2011-08-25	Anand; Siddharth	
/T.T./	2	20110265157		2011-10-27	Ryder; Scott	
/T.T./	3	20110313898		2011-12-22	Singhal; Nitesh	
/T.T./	4	20110320345		2011-12-29	Taveau; Sebastien	

<b>Receipt date: 01/11/2013</b>  <b>INFORMATION DISCLOSURE STATEMENT BY APPLICANT</b> ( Not for submission under 37 CFR 1.99)	Application Number		13740086 - GAU: 2494	
	Filing Date		2013-01-11	
	First Named Inventor	William Grecia		
	Art Unit			
	Examiner Name			
	Attorney Docket Number			

/T.T./	5	20120041829		2012-02-16	Rothschild; Keith Alan	
/T.T./	6	20120130903		2012-03-24	Dorsey; Jack	
/T.T./	7	20120079095		2012-03-29	Evans; Ethan	
/T.T./	8	20120079126		2012-03-29	Evans; Ethan	
/T.T./	9	20120079276		2012-03-29	Evans; Ethan	
/T.T./	10	20120079606		2012-03-29	Evans; Ethan	
/T.T./	11	20120095916		2012-04-19	Dorsey; Jack	
/T.T./	12	20120095906		2012-04-19	Dorsey; Jack	
/T.T./	13	20120095871		2012-04-19	Dorsey; Jack	
/T.T./	14	20120150727		2012-06-14	Nuzzi; Frank Anthony	
/T.T./	15	20120166333		2012-06-28	von Behren; Rob	

<b>INFORMATION DISCLOSURE STATEMENT BY APPLICANT</b> ( Not for submission under 37 CFR 1.99)	Application Number		13740086 - GAU: 2494	
	Filing Date		2013-01-11	
	First Named Inventor	William Grecia		
	Art Unit			
	Examiner Name			
	Attorney Docket Number			
	Receipt date: 01/11/2013			

/T.T./	16	20120173333		2012-07-05	Berger; Richard	
/T.T./	17	20120173625		2012-07-05	Berger; Richard	
/T.T./	18	20120173431		2012-07-05	Ritchie; Ben	
/T.T./	19	20120191553		2012-07-26	Sathe; Nikhil S	
/T.T./	20	20110208695		2011-08-25	Anand; Siddharth	
/T.T./	21	20120254340		2012-10-04	Velummylum; Piragash	
/T.T./	22	20120255033		2012-10-04	Dwivedi; Sanjeev	
/T.T./	23	20120290376		2012-11-15	Dryer; Trevor D.	
/T.T./	24	20120296741		2012-11-22	Dykes; Robert	
/T.T./	25	20120310828		2012-12-06	Hu; Qilin	
/T.T./	26	20110313898		2011-12-22	Singhal; Nitesh	

<b>INFORMATION DISCLOSURE STATEMENT BY APPLICANT</b> ( Not for submission under 37 CFR 1.99)	Application Number		13740086 - GAU: 2494	
	Filing Date		2013-01-11	
	First Named Inventor	William Grecia		
	Art Unit			
	Examiner Name			
	Attorney Docket Number			

/T.T./	27	20110320345		2011-12-29	Taveau; Sebastien	
/T.T./	28	20130007892		2013-01-03	Inooka, Hidehiro	

If you wish to add additional U.S. Published Application citation information please click the Add button. **Add**

**FOREIGN PATENT DOCUMENTS**

Remove

Examiner Initial*	Cite No	Foreign Document Number <sup>3</sup>	Country Code <sup>2</sup>	Kind Code <sup>4</sup>	Publication Date	Name of Patentee or Applicant of cited Document	Pages, Columns, Lines where Relevant Passages or Relevant Figures Appear	T <sup>5</sup>
	1							<input type="checkbox"/>

If you wish to add additional Foreign Patent Document citation information please click the Add button **Add**

**NON-PATENT LITERATURE DOCUMENTS**

Remove

Examiner Initials*	Cite No	Include name of the author (in CAPITAL LETTERS), title of the article (when appropriate), title of the item (book, magazine, journal, serial, symposium, catalog, etc), date, pages(s), volume-issue number(s), publisher, city and/or country where published.	T <sup>5</sup>
	1		<input type="checkbox"/>

If you wish to add additional non-patent literature document citation information please click the Add button **Add**

**EXAMINER SIGNATURE**

Examiner Signature	/Tri Tran/ (05/14/2013)	Date Considered	05/14/2013
--------------------	-------------------------	-----------------	------------

\*EXAMINER: Initial if reference considered, whether or not citation is in conformance with MPEP 609. Draw line through a citation if not in conformance and not considered. Include copy of this form with next communication to applicant.

<sup>1</sup> See Kind Codes of USPTO Patent Documents at [www.USPTO.GOV](http://www.USPTO.GOV) or MPEP 901.04. <sup>2</sup> Enter office that issued the document, by the two-letter code (WIPO Standard ST.3). <sup>3</sup> For Japanese patent documents, the indication of the year of the reign of the Emperor must precede the serial number of the patent document. <sup>4</sup> Kind of document by the appropriate symbols as indicated on the document under WIPO Standard ST.16 if possible. <sup>5</sup> Applicant is to place a check mark here if English language translation is attached.

<b>INFORMATION DISCLOSURE STATEMENT BY APPLICANT</b> ( Not for submission under 37 CFR 1.99)	Application Number		13740086 - GAU: 2494
	Filing Date		2013-01-11
	First Named Inventor	William Grecia	
	Art Unit		
	Examiner Name		
	Attorney Docket Number		

**CERTIFICATION STATEMENT**

Please see 37 CFR 1.97 and 1.98 to make the appropriate selection(s):

That each item of information contained in the information disclosure statement was first cited in any communication from a foreign patent office in a counterpart foreign application not more than three months prior to the filing of the information disclosure statement. See 37 CFR 1.97(e)(1).

**OR**

That no item of information contained in the information disclosure statement was cited in a communication from a foreign patent office in a counterpart foreign application, and, to the knowledge of the person signing the certification after making reasonable inquiry, no item of information contained in the information disclosure statement was known to any individual designated in 37 CFR 1.56(c) more than three months prior to the filing of the information disclosure statement. See 37 CFR 1.97(e)(2).

- See attached certification statement.
- The fee set forth in 37 CFR 1.17 (p) has been submitted herewith.
- A certification statement is not submitted herewith.

**SIGNATURE**

A signature of the applicant or representative is required in accordance with CFR 1.33, 10.18. Please see CFR 1.4(d) for the form of the signature.

Signature	/william grecia/	Date (YYYY-MM-DD)	2013-01-11
Name/Print	William Grecia	Registration Number	70984

This collection of information is required by 37 CFR 1.97 and 1.98. The information is required to obtain or retain a benefit by the public which is to file (and by the USPTO to process) an application. Confidentiality is governed by 35 U.S.C. 122 and 37 CFR 1.14. This collection is estimated to take 1 hour to complete, including gathering, preparing and submitting the completed application form to the USPTO. Time will vary depending upon the individual case. Any comments on the amount of time you require to complete this form and/or suggestions for reducing this burden, should be sent to the Chief Information Officer, U.S. Patent and Trademark Office, U.S. Department of Commerce, P.O. Box 1450, Alexandria, VA 22313-1450. **DO NOT SEND FEES OR COMPLETED FORMS TO THIS ADDRESS. SEND TO: Commissioner for Patents, P.O. Box 1450, Alexandria, VA 22313-1450.**

**Privacy Act Statement**

The Privacy Act of 1974 (P.L. 93-579) requires that you be given certain information in connection with your submission of the attached form related to a patent application or patent. Accordingly, pursuant to the requirements of the Act, please be advised that: (1) the general authority for the collection of this information is 35 U.S.C. 2(b)(2); (2) furnishing of the information solicited is voluntary; and (3) the principal purpose for which the information is used by the U.S. Patent and Trademark Office is to process and/or examine your submission related to a patent application or patent. If you do not furnish the requested information, the U.S. Patent and Trademark Office may not be able to process and/or examine your submission, which may result in termination of proceedings or abandonment of the application or expiration of the patent.

The information provided by you in this form will be subject to the following routine uses:

1. The information on this form will be treated confidentially to the extent allowed under the Freedom of Information Act (5 U.S.C. 552) and the Privacy Act (5 U.S.C. 552a). Records from this system of records may be disclosed to the Department of Justice to determine whether the Freedom of Information Act requires disclosure of these records.
2. A record from this system of records may be disclosed, as a routine use, in the course of presenting evidence to a court, magistrate, or administrative tribunal, including disclosures to opposing counsel in the course of settlement negotiations.
3. A record in this system of records may be disclosed, as a routine use, to a Member of Congress submitting a request involving an individual, to whom the record pertains, when the individual has requested assistance from the Member with respect to the subject matter of the record.
4. A record in this system of records may be disclosed, as a routine use, to a contractor of the Agency having need for the information in order to perform a contract. Recipients of information shall be required to comply with the requirements of the Privacy Act of 1974, as amended, pursuant to 5 U.S.C. 552a(m).
5. A record related to an International Application filed under the Patent Cooperation Treaty in this system of records may be disclosed, as a routine use, to the International Bureau of the World Intellectual Property Organization, pursuant to the Patent Cooperation Treaty.
6. A record in this system of records may be disclosed, as a routine use, to another federal agency for purposes of National Security review (35 U.S.C. 181) and for review pursuant to the Atomic Energy Act (42 U.S.C. 218(c)).
7. A record from this system of records may be disclosed, as a routine use, to the Administrator, General Services, or his/her designee, during an inspection of records conducted by GSA as part of that agency's responsibility to recommend improvements in records management practices and programs, under authority of 44 U.S.C. 2904 and 2906. Such disclosure shall be made in accordance with the GSA regulations governing inspection of records for this purpose, and any other relevant (i.e., GSA or Commerce) directive. Such disclosure shall not be used to make determinations about individuals.
8. A record from this system of records may be disclosed, as a routine use, to the public after either publication of the application pursuant to 35 U.S.C. 122(b) or issuance of a patent pursuant to 35 U.S.C. 151. Further, a record may be disclosed, subject to the limitations of 37 CFR 1.14, as a routine use, to the public if the record was filed in an application which became abandoned or in which the proceedings were terminated and which application is referenced by either a published application, an application open to public inspections or an issued patent.
9. A record from this system of records may be disclosed, as a routine use, to a Federal, State, or local law enforcement agency, if the USPTO becomes aware of a violation or potential violation of law or regulation.

Receipt date: 01/13/2013

13740086 - GAI: 2494

Doc code: IDS

Pat. Class. (01-10)

Doc description: Information Disclosure Statement (IDS) Filed

Approved for use through 07/31/2012. OMB 0651-0031

U.S. Patent and Trademark Office; U.S. DEPARTMENT OF COMMERCE

Under the Paperwork Reduction Act of 1995, no persons are required to respond to a collection of information unless it contains a valid OMB control number.

<b>INFORMATION DISCLOSURE STATEMENT BY APPLICANT</b> ( Not for submission under 37 CFR 1.99)	Application Number		13740086	
	Filing Date		2013-01-11	
	First Named Inventor	William Grecia		
	Art Unit	243xx 2494		
	Examiner Name	Tri Tran		
	Attorney Docket Number			

U.S.PATENTS						Remove
Examiner Initial*	Cite No	Patent Number	Kind Code <sup>1</sup>	Issue Date	Name of Patentee or Applicant of cited Document	Pages,Columns,Lines where Relevant Passages or Relevant Figures Appear
/T.T./	1	8250145		2012-08-21	Zuckerberg; Mark	
/T.T./	2	8280959		2012-10-02	Zuckerberg; Mark	

If you wish to add additional U.S. Patent citation information please click the Add button.

Add

U.S.PATENT APPLICATION PUBLICATIONS						Remove
Examiner Initial*	Cite No	Publication Number	Kind Code <sup>1</sup>	Publication Date	Name of Patentee or Applicant of cited Document	Pages,Columns,Lines where Relevant Passages or Relevant Figures Appear
/T.T./	1	20110208695		2011-08-25	Anand; Siddharth	
/T.T./	2	20110265157		2011-10-27	Ryder; Scott	
/T.T./	3	20110313898		2011-12-22	Singhal; Nitesh	
/T.T./	4	20110320345		2011-12-29	Taveau; Sebastien	

<b>INFORMATION DISCLOSURE STATEMENT BY APPLICANT</b> ( Not for submission under 37 CFR 1.99)	Receipt date: 01/13/2013		Application Number	13740086	13740086 - GAU: 2494	
			Filing Date	2013-01-11		
			First Named Inventor	William Grecia		
			Art Unit	<del>2431</del> 2494		
			Examiner Name	Tri Tran		
			Attorney Docket Number			

/T.T./	5	20120041829		2012-02-16	Rothschild; Keith Alan	
/T.T./	6	20120130903		2012-03-24	Dorsey; Jack	
/T.T./	7	20120079095		2012-03-29	Evans; Ethan	
/T.T./	8	20120079126		2012-03-29	Evans; Ethan	
/T.T./	9	20120079276		2012-03-29	Evans; Ethan	
/T.T./	10	20120079606		2012-03-29	Evans; Ethan	
/T.T./	11	20120095916		2012-04-19	Dorsey; Jack	
/T.T./	12	20120095906		2012-04-19	Dorsey; Jack	
/T.T./	13	20120095871		2012-04-19	Dorsey; Jack	
/T.T./	14	20120150727		2012-06-14	Nuzzi; Frank Anthony	
/T.T./	15	20120166333		2012-06-28	von Behren; Rob	



<b>INFORMATION DISCLOSURE STATEMENT BY APPLICANT</b> ( Not for submission under 37 CFR 1.99)	Receipt date: 01/13/2013		Application Number	13740086	13740086 - GAU: 2494	
			Filing Date	2013-01-11		
			First Named Inventor	William Grecia		
			Art Unit	<del>2431</del> x	2494	
			Examiner Name	Tri Tran		
			Attorney Docket Number			

/T.T./	16	20120173333		2012-07-05	Berger; Richard	
/T.T./	17	20120173625		2012-07-05	Berger; Richard	
/T.T./	18	20120173431		2012-07-05	Ritchie; Ben	
/T.T./	19	20120191553		2012-07-26	Sathe; Nikhil S	
/T.T./	20	20110208695		2011-08-25	Anand; Siddharth	
/T.T./	21	20120254340		2012-10-04	Velummylum; Piragash	
/T.T./	22	20120255033		2012-10-04	Dwivedi; Sanjeev	
/T.T./	23	20120290376		2012-11-15	Dryer; Trevor D.	
/T.T./	24	20120296741		2012-11-22	Dykes; Robert	
/T.T./	25	20120310828		2012-12-06	Hu; Qilin	
/T.T./	26	20110313898		2011-12-22	Singhal; Nitesh	

<b>INFORMATION DISCLOSURE STATEMENT BY APPLICANT</b> ( Not for submission under 37 CFR 1.99)	Receipt date: 01/13/2013	Application Number	13740086	13740086 - GAU: 2494
	Filing Date	2013-01-11		
	First Named Inventor	William Grecia		
	Art Unit	243* 2494		
	Examiner Name	Tri Tran		
	Attorney Docket Number			

/T.T./	27	20110320345		2011-12-29	Taveau; Sebastien	
/T.T./	28	20130007892		2013-01-03	Inooka, Hidehiro	

If you wish to add additional U.S. Published Application citation information please click the Add button. **Add**

**FOREIGN PATENT DOCUMENTS**

Remove

Examiner Initial*	Cite No	Foreign Document Number <sup>3</sup>	Country Code <sup>2</sup>	Kind Code <sup>4</sup>	Publication Date	Name of Patentee or Applicant of cited Document	Pages, Columns, Lines where Relevant Passages or Relevant Figures Appear	T <sup>5</sup>
	1							<input type="checkbox"/>

If you wish to add additional Foreign Patent Document citation information please click the Add button **Add**

**NON-PATENT LITERATURE DOCUMENTS**

Remove

Examiner Initials*	Cite No	Include name of the author (in CAPITAL LETTERS), title of the article (when appropriate), title of the item (book, magazine, journal, serial, symposium, catalog, etc), date, pages(s), volume-issue number(s), publisher, city and/or country where published.	T <sup>5</sup>
	1		<input type="checkbox"/>

If you wish to add additional non-patent literature document citation information please click the Add button **Add**

**EXAMINER SIGNATURE**

Examiner Signature	/Tri Tran/ (05/14/2013)	Date Considered	05/14/2013
--------------------	-------------------------	-----------------	------------

\*EXAMINER: Initial if reference considered, whether or not citation is in conformance with MPEP 609. Draw line through a citation if not in conformance and not considered. Include copy of this form with next communication to applicant.

<sup>1</sup> See Kind Codes of USPTO Patent Documents at [www.USPTO.GOV](http://www.USPTO.GOV) or MPEP 901.04. <sup>2</sup> Enter office that issued the document, by the two-letter code (WIPO Standard ST.3). <sup>3</sup> For Japanese patent documents, the indication of the year of the reign of the Emperor must precede the serial number of the patent document. <sup>4</sup> Kind of document by the appropriate symbols as indicated on the document under WIPO Standard ST.16 if possible. <sup>5</sup> Applicant is to place a check mark here if English language translation is attached.

<b>INFORMATION DISCLOSURE STATEMENT BY APPLICANT</b> ( Not for submission under 37 CFR 1.99)	Application Number	13740086	13740086 - GAU: 2494
	Filing Date	2013-01-11	
	First Named Inventor	William Grecia	
	Art Unit	243xx 2494	
	Examiner Name	Tri Tran	
	Attorney Docket Number		

**CERTIFICATION STATEMENT**

Please see 37 CFR 1.97 and 1.98 to make the appropriate selection(s):

That each item of information contained in the information disclosure statement was first cited in any communication from a foreign patent office in a counterpart foreign application not more than three months prior to the filing of the information disclosure statement. See 37 CFR 1.97(e)(1).

**OR**

That no item of information contained in the information disclosure statement was cited in a communication from a foreign patent office in a counterpart foreign application, and, to the knowledge of the person signing the certification after making reasonable inquiry, no item of information contained in the information disclosure statement was known to any individual designated in 37 CFR 1.56(c) more than three months prior to the filing of the information disclosure statement. See 37 CFR 1.97(e)(2).

- See attached certification statement.
- The fee set forth in 37 CFR 1.17 (p) has been submitted herewith.
- A certification statement is not submitted herewith.

**SIGNATURE**

A signature of the applicant or representative is required in accordance with CFR 1.33, 10.18. Please see CFR 1.4(d) for the form of the signature.

Signature	/william grecia/	Date (YYYY-MM-DD)	2013-01-11
Name/Print	William Grecia	Registration Number	70984

This collection of information is required by 37 CFR 1.97 and 1.98. The information is required to obtain or retain a benefit by the public which is to file (and by the USPTO to process) an application. Confidentiality is governed by 35 U.S.C. 122 and 37 CFR 1.14. This collection is estimated to take 1 hour to complete, including gathering, preparing and submitting the completed application form to the USPTO. Time will vary depending upon the individual case. Any comments on the amount of time you require to complete this form and/or suggestions for reducing this burden, should be sent to the Chief Information Officer, U.S. Patent and Trademark Office, U.S. Department of Commerce, P.O. Box 1450, Alexandria, VA 22313-1450. **DO NOT SEND FEES OR COMPLETED FORMS TO THIS ADDRESS. SEND TO: Commissioner for Patents, P.O. Box 1450, Alexandria, VA 22313-1450.**

**Privacy Act Statement**

The Privacy Act of 1974 (P.L. 93-579) requires that you be given certain information in connection with your submission of the attached form related to a patent application or patent. Accordingly, pursuant to the requirements of the Act, please be advised that: (1) the general authority for the collection of this information is 35 U.S.C. 2(b)(2); (2) furnishing of the information solicited is voluntary; and (3) the principal purpose for which the information is used by the U.S. Patent and Trademark Office is to process and/or examine your submission related to a patent application or patent. If you do not furnish the requested information, the U.S. Patent and Trademark Office may not be able to process and/or examine your submission, which may result in termination of proceedings or abandonment of the application or expiration of the patent.

The information provided by you in this form will be subject to the following routine uses:

1. The information on this form will be treated confidentially to the extent allowed under the Freedom of Information Act (5 U.S.C. 552) and the Privacy Act (5 U.S.C. 552a). Records from this system of records may be disclosed to the Department of Justice to determine whether the Freedom of Information Act requires disclosure of these records.
2. A record from this system of records may be disclosed, as a routine use, in the course of presenting evidence to a court, magistrate, or administrative tribunal, including disclosures to opposing counsel in the course of settlement negotiations.
3. A record in this system of records may be disclosed, as a routine use, to a Member of Congress submitting a request involving an individual, to whom the record pertains, when the individual has requested assistance from the Member with respect to the subject matter of the record.
4. A record in this system of records may be disclosed, as a routine use, to a contractor of the Agency having need for the information in order to perform a contract. Recipients of information shall be required to comply with the requirements of the Privacy Act of 1974, as amended, pursuant to 5 U.S.C. 552a(m).
5. A record related to an International Application filed under the Patent Cooperation Treaty in this system of records may be disclosed, as a routine use, to the International Bureau of the World Intellectual Property Organization, pursuant to the Patent Cooperation Treaty.
6. A record in this system of records may be disclosed, as a routine use, to another federal agency for purposes of National Security review (35 U.S.C. 181) and for review pursuant to the Atomic Energy Act (42 U.S.C. 218(c)).
7. A record from this system of records may be disclosed, as a routine use, to the Administrator, General Services, or his/her designee, during an inspection of records conducted by GSA as part of that agency's responsibility to recommend improvements in records management practices and programs, under authority of 44 U.S.C. 2904 and 2906. Such disclosure shall be made in accordance with the GSA regulations governing inspection of records for this purpose, and any other relevant (i.e., GSA or Commerce) directive. Such disclosure shall not be used to make determinations about individuals.
8. A record from this system of records may be disclosed, as a routine use, to the public after either publication of the application pursuant to 35 U.S.C. 122(b) or issuance of a patent pursuant to 35 U.S.C. 151. Further, a record may be disclosed, subject to the limitations of 37 CFR 1.14, as a routine use, to the public if the record was filed in an application which became abandoned or in which the proceedings were terminated and which application is referenced by either a published application, an application open to public inspections or an issued patent.
9. A record from this system of records may be disclosed, as a routine use, to a Federal, State, or local law enforcement agency, if the USPTO becomes aware of a violation or potential violation of law or regulation.

Receipt date: 02/04/2013

13740086 - GAI: 2494

Doc code: IDS

Doc description: Information Disclosure Statement (IDS) Filed

Approved for use through 07/31/2012. OMB 0651-0031  
U.S. Patent and Trademark Office; U.S. DEPARTMENT OF COMMERCE

Under the Paperwork Reduction Act of 1995, no persons are required to respond to a collection of information unless it contains a valid OMB control number.

<b>INFORMATION DISCLOSURE STATEMENT BY APPLICANT</b> ( Not for submission under 37 CFR 1.99)	Application Number	13740086
	Filing Date	2013-01-11
	First Named Inventor	William Grecia
	Art Unit	2421xx 2494
	Examiner Name	Not Applicable Tri Tran
	Attorney Docket Number	

U.S.PATENTS						Remove
Examiner Initial*	Cite No	Patent Number	Kind Code <sup>1</sup>	Issue Date	Name of Patentee or Applicant of cited Document	Pages,Columns,Lines where Relevant Passages or Relevant Figures Appear
	1					

If you wish to add additional U.S. Patent citation information please click the Add button. Add

U.S.PATENT APPLICATION PUBLICATIONS						Remove
Examiner Initial*	Cite No	Publication Number	Kind Code <sup>1</sup>	Publication Date	Name of Patentee or Applicant of cited Document	Pages,Columns,Lines where Relevant Passages or Relevant Figures Appear
	1					

If you wish to add additional U.S. Published Application citation information please click the Add button. Add

FOREIGN PATENT DOCUMENTS								Remove
Examiner Initial*	Cite No	Foreign Document Number <sup>3</sup>	Country Code <sup>2</sup> j	Kind Code <sup>4</sup>	Publication Date	Name of Patentee or Applicant of cited Document	Pages,Columns,Lines where Relevant Passages or Relevant Figures Appear	T <sup>5</sup>
	1							<input type="checkbox"/>

If you wish to add additional Foreign Patent Document citation information please click the Add button Add

NON-PATENT LITERATURE DOCUMENTS				Remove
Examiner Initials*	Cite No	Include name of the author (in CAPITAL LETTERS), title of the article (when appropriate), title of the item (book, magazine, journal, serial, symposium, catalog, etc), date, pages(s), volume-issue number(s), publisher, city and/or country where published.		T <sup>5</sup>

<b>INFORMATION DISCLOSURE STATEMENT BY APPLICANT</b> ( Not for submission under 37 CFR 1.99)	Receipt date: 02/04/2013	Application Number	13740086	13740086 - GAU: 2494
	Filing Date	2013-01-11		
	First Named Inventor	William Grecia		
	Art Unit	<del>2494</del> x 2494		
	Examiner Name	Not Applicable Tri Tran		
	Attorney Docket Number			

/T.T./	1	Copy of co-pending U.S. patent application #13/397,517 document reference: 2013-02-04 Notice of Allowance and Fees Due (PTOL-85)	<input type="checkbox"/>
/T.T./	2	Copy of co-pending U.S. patent application #13/397,517 document reference: 2013-02-04 Examiner initiated interview summary (PTOL-413B)	<input type="checkbox"/>
/T.T./	3	Copy of co-pending U.S. patent application #13/397,517 document reference: 2013-02-04 Examiner's Amendment and Detailed Action	<input type="checkbox"/>
/T.T./	4	Copy of co-pending U.S. patent application #13/397,517 document reference: 2013-02-04 Issue Information including classification, examiner, name, claim, renumbering, etc.	<input type="checkbox"/>
/T.T./	5	Copy of co-pending U.S. patent application #13/397,517 document reference: 2013-02-04 List of References cited by applicant and considered by examiner	<input type="checkbox"/>
/T.T./	6	Copy of co-pending U.S. patent application #13/397,517 document reference: 2013-02-04 Index of Claims	<input type="checkbox"/>
/T.T./	7	Copy of co-pending U.S. patent application #13/397,517 document reference: 2013-02-04 Search information including classification, databases and other search related notes	<input type="checkbox"/>
/T.T./	8	Copy of co-pending U.S. patent application #13/397,517 document reference: 2013-02-04 Examiner's search strategy and results	<input type="checkbox"/>

If you wish to add additional non-patent literature document citation information please click the Add button **Add**

**EXAMINER SIGNATURE**

Examiner Signature	/Tri Tran/ (05/14/2013)	Date Considered	05/14/2013
--------------------	-------------------------	-----------------	------------

\*EXAMINER: Initial if reference considered, whether or not citation is in conformance with MPEP 609. Draw line through a citation if not in conformance and not considered. Include copy of this form with next communication to applicant.

<sup>1</sup> See Kind Codes of USPTO Patent Documents at [www.USPTO.GOV](http://www.USPTO.GOV) or MPEP 901.04. <sup>2</sup> Enter office that issued the document, by the two-letter code (WIPO Standard ST.3). <sup>3</sup> For Japanese patent documents, the indication of the year of the reign of the Emperor must precede the serial number of the patent document. <sup>4</sup> Kind of document by the appropriate symbols as indicated on the document under WIPO Standard ST.16 if possible. <sup>5</sup> Applicant is to place a check mark here if English language translation is attached.

<b>INFORMATION DISCLOSURE STATEMENT BY APPLICANT</b> ( Not for submission under 37 CFR 1.99)	Application Number	13740086	13740086 - GAU: 2494
	Filing Date	2013-01-11	
	First Named Inventor	William Grecia	
	Art Unit	<del>243</del> ×	2494
	Examiner Name	Not Applicable	Tri Tran
	Attorney Docket Number		

**CERTIFICATION STATEMENT**

Please see 37 CFR 1.97 and 1.98 to make the appropriate selection(s):

That each item of information contained in the information disclosure statement was first cited in any communication from a foreign patent office in a counterpart foreign application not more than three months prior to the filing of the information disclosure statement. See 37 CFR 1.97(e)(1).

**OR**

That no item of information contained in the information disclosure statement was cited in a communication from a foreign patent office in a counterpart foreign application, and, to the knowledge of the person signing the certification after making reasonable inquiry, no item of information contained in the information disclosure statement was known to any individual designated in 37 CFR 1.56(c) more than three months prior to the filing of the information disclosure statement. See 37 CFR 1.97(e)(2).

- See attached certification statement.
- The fee set forth in 37 CFR 1.17 (p) has been submitted herewith.
- A certification statement is not submitted herewith.

**SIGNATURE**

A signature of the applicant or representative is required in accordance with CFR 1.33, 10.18. Please see CFR 1.4(d) for the form of the signature.

Signature	/william grecia/	Date (YYYY-MM-DD)	2013-02-04
Name/Print	William Grecia	Registration Number	70984

This collection of information is required by 37 CFR 1.97 and 1.98. The information is required to obtain or retain a benefit by the public which is to file (and by the USPTO to process) an application. Confidentiality is governed by 35 U.S.C. 122 and 37 CFR 1.14. This collection is estimated to take 1 hour to complete, including gathering, preparing and submitting the completed application form to the USPTO. Time will vary depending upon the individual case. Any comments on the amount of time you require to complete this form and/or suggestions for reducing this burden, should be sent to the Chief Information Officer, U.S. Patent and Trademark Office, U.S. Department of Commerce, P.O. Box 1450, Alexandria, VA 22313-1450. **DO NOT SEND FEES OR COMPLETED FORMS TO THIS ADDRESS. SEND TO: Commissioner for Patents, P.O. Box 1450, Alexandria, VA 22313-1450.**

**Privacy Act Statement**

The Privacy Act of 1974 (P.L. 93-579) requires that you be given certain information in connection with your submission of the attached form related to a patent application or patent. Accordingly, pursuant to the requirements of the Act, please be advised that: (1) the general authority for the collection of this information is 35 U.S.C. 2(b)(2); (2) furnishing of the information solicited is voluntary; and (3) the principal purpose for which the information is used by the U.S. Patent and Trademark Office is to process and/or examine your submission related to a patent application or patent. If you do not furnish the requested information, the U.S. Patent and Trademark Office may not be able to process and/or examine your submission, which may result in termination of proceedings or abandonment of the application or expiration of the patent.

The information provided by you in this form will be subject to the following routine uses:

1. The information on this form will be treated confidentially to the extent allowed under the Freedom of Information Act (5 U.S.C. 552) and the Privacy Act (5 U.S.C. 552a). Records from this system of records may be disclosed to the Department of Justice to determine whether the Freedom of Information Act requires disclosure of these records.
2. A record from this system of records may be disclosed, as a routine use, in the course of presenting evidence to a court, magistrate, or administrative tribunal, including disclosures to opposing counsel in the course of settlement negotiations.
3. A record in this system of records may be disclosed, as a routine use, to a Member of Congress submitting a request involving an individual, to whom the record pertains, when the individual has requested assistance from the Member with respect to the subject matter of the record.
4. A record in this system of records may be disclosed, as a routine use, to a contractor of the Agency having need for the information in order to perform a contract. Recipients of information shall be required to comply with the requirements of the Privacy Act of 1974, as amended, pursuant to 5 U.S.C. 552a(m).
5. A record related to an International Application filed under the Patent Cooperation Treaty in this system of records may be disclosed, as a routine use, to the International Bureau of the World Intellectual Property Organization, pursuant to the Patent Cooperation Treaty.
6. A record in this system of records may be disclosed, as a routine use, to another federal agency for purposes of National Security review (35 U.S.C. 181) and for review pursuant to the Atomic Energy Act (42 U.S.C. 218(c)).
7. A record from this system of records may be disclosed, as a routine use, to the Administrator, General Services, or his/her designee, during an inspection of records conducted by GSA as part of that agency's responsibility to recommend improvements in records management practices and programs, under authority of 44 U.S.C. 2904 and 2906. Such disclosure shall be made in accordance with the GSA regulations governing inspection of records for this purpose, and any other relevant (i.e., GSA or Commerce) directive. Such disclosure shall not be used to make determinations about individuals.
8. A record from this system of records may be disclosed, as a routine use, to the public after either publication of the application pursuant to 35 U.S.C. 122(b) or issuance of a patent pursuant to 35 U.S.C. 151. Further, a record may be disclosed, subject to the limitations of 37 CFR 1.14, as a routine use, to the public if the record was filed in an application which became abandoned or in which the proceedings were terminated and which application is referenced by either a published application, an application open to public inspections or an issued patent.
9. A record from this system of records may be disclosed, as a routine use, to a Federal, State, or local law enforcement agency, if the USPTO becomes aware of a violation or potential violation of law or regulation.



<b>Search Notes</b>  	<b>Application/Control No.</b>  13740086	<b>Applicant(s)/Patent Under Reexamination</b>  GRECIA, WILLIAM
	<b>Examiner</b>  TRI TRAN	<b>Art Unit</b>  2494

CPC- SEARCHED		
Symbol	Date	Examiner

CPC COMBINATION SETS - SEARCHED		
Symbol	Date	Examiner

US CLASSIFICATION SEARCHED			
Class	Subclass	Date	Examiner

SEARCH NOTES		
Search Notes	Date	Examiner
Inventor Search	5/14/13	TT
Espacenet.com, EAST, and Google	5/14/13	TT
Consulted with Jung Kim (SPE)	5/13/13	TT
reviewed prior art of record from parent case 13/397517	5/13/13	TT
class 705/51 with text search	5/19/13	TT
class 713/155-159, 168, 172-176, 182, 185 with text search	5/13/13	TT
class 726/1-21, 26-33 with text search	5/13/13	TT

INTERFERENCE SEARCH			
US Class/ CPC Symbol	US Subclass / CPC Group	Date	Examiner
726	1-7, 9, 16-21, 26-32	5/14/13	TT
713	168	5/14/13	TT
705	51	5/19/13	TT

--	--

<b>Issue Classification</b> 	<b>Application/Control No.</b> 13740086	<b>Applicant(s)/Patent Under Reexamination</b> GRECIA, WILLIAM
	<b>Examiner</b> TRI TRAN	<b>Art Unit</b> 2494

CPC		
Symbol	Type	Version

CPC Combination Sets				
Symbol	Type	Set	Ranking	Version

US ORIGINAL CLASSIFICATION				INTERNATIONAL CLASSIFICATION							
CLASS		SUBCLASS		CLAIMED				NON-CLAIMED			
726		29		H	0	4	L	29 / 06 (2006.01.01)			
<b>CROSS REFERENCE(S)</b>											
CLASS	SUBCLASS (ONE SUBCLASS PER BLOCK)										
725	28										
713	185										

/TRI TRAN/ Examiner, Art Unit 2494	05/14/2013	<b>Total Claims Allowed:</b>	
(Assistant Examiner)	(Date)	30	
/Jung Kim/ Supervisory Patent Examiner, Art Unit 2494	5/28/13	O.G. Print Claim(s)	O.G. Print Figure
(Primary Examiner)	(Date)	1	6

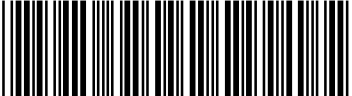
<b>Issue Classification</b> 	<b>Application/Control No.</b> 13740086	<b>Applicant(s)/Patent Under Reexamination</b> GRECIA, WILLIAM
	<b>Examiner</b> TRI TRAN	<b>Art Unit</b> 2494

705	51																	

/TRI TRAN/ Examiner, Art Unit 2494  (Assistant Examiner)	05/14/2013  (Date)	<b>Total Claims Allowed:</b>  30	
/Jung Kim/ Supervisory Patent Examiner, Art Unit 2494  (Primary Examiner)	5/28/13  (Date)	O.G. Print Claim(s)  1	O.G. Print Figure  6

<b>Issue Classification</b> 	<b>Application/Control No.</b> 13740086	<b>Applicant(s)/Patent Under Reexamination</b> GRECIA, WILLIAM
	<b>Examiner</b> TRI TRAN	<b>Art Unit</b> 2494

<input checked="" type="checkbox"/> <b>Claims renumbered in the same order as presented by applicant</b> <input type="checkbox"/> <b>CPA</b> <input checked="" type="checkbox"/> <b>T.D.</b> <input type="checkbox"/> <b>R.1.47</b>															
Final	Original	Final	Original	Final	Original	Final	Original	Final	Original	Final	Original	Final	Original	Final	Original
	1		17												
	2		18												
	3		19												
	4		20												
	5		21												
	6		22												
	7		23												
	8		24												
	9		25												
	10		26												
	11		27												
	12		28												
	13		29												
	14		30												
	15														
	16														

/TRI TRAN/ Examiner, Art Unit 2494  (Assistant Examiner)	05/14/2013  (Date)	<b>Total Claims Allowed:</b>  30	
/Jung Kim/ Supervisory Patent Examiner, Art Unit 2494  (Primary Examiner)	5/28/13  (Date)	O.G. Print Claim(s)  1	O.G. Print Figure  6

## EAST Search History

## EAST Search History (Prior Art)

Ref #	Hits	Search Query	DBs	Default Operator	Plurals	Time Stamp
L1	3191	705/51.ccls.	US-PGPUB; USPAT; USOCR; FPRS; EPO; JPO; DERWENT; IBM_TDB	OR	OFF	2013/05/19 21:04
L2	62	705/51.ccls. and ((writ\$3 request modif\$3) with (metadata meta-data meta adj data) same (digital adj media data object))	US-PGPUB; USPAT; USOCR; FPRS; EPO; JPO; DERWENT; IBM_TDB	OR	OFF	2013/05/19 21:06
L5	43	2 and shar\$3	US-PGPUB; USPAT; USOCR; FPRS; EPO; JPO; DERWENT; IBM_TDB	OR	OFF	2013/05/19 21:09
L6	6	705/51.ccls. and ((writ\$3 request modif\$3) with (metadata meta-data meta adj data) same (digital adj media data object) same3 shar\$3)	US-PGPUB; USPAT; USOCR; FPRS; EPO; JPO; DERWENT; IBM_TDB	OR	OFF	2013/05/19 21:09
S1	0	"13397517"	US-PGPUB; USPAT; USOCR; FPRS; EPO; JPO; DERWENT; IBM_TDB	OR	OFF	2012/05/06 22:07
S3	124	((("7266839") or ("7567987") or ("20070266095") or ("20090100060") or ("20070010334") or ("20060036554") or ("7634734") or ("20080111052") or ("20030018491") or ("7610630") or ("7689823") or ("7702592") or ("7515710") or ("6799165") or ("6385596") or ("5907617") or ("5903647") or ("5887060") or ("5883955") or ("5870543") or ("5883954") or ("7290699") or ("7340769") or ("7343014") or ("7386513") or ("7571328") or ("7624417") or ("20020010759") or	US-PGPUB; USPAT; USOCR; EPO; JPO; DERWENT; IBM_TDB	OR	OFF	2012/05/07 13:55

EWS-003811

		( ("20020157002") or ("20040024670") or ("20040062400") or ("20040162786") or ("20040220878") or ("20050066353") or ("20050182727") or ("20060173787") or ("20060173789") or ("20060259652") or ("20060259982") or ("20070055887") or ("20070156719") or ("20070179854") or ("20070180485") or ("20070250445") or ("20080027869") or ("20080091606") or ("20080109911") or ("20080165956") or ("20090012805") or ("20090049556") or ("20090083541") or ("20090183010") or ("20090217036") or ("20090254930") or ("20090257591") or ("20090265278") or ("20090299963") or ("20090307078") or ("20090327702") or ("20090328228")) .PN.				
S4	60	( ("7266839") or ("7567987") or ("20070266095") or ("20090100060") or ("20070010334") or ("20060036554") or ("7634734") or ("20080111052") or ("20030018491") or ("7610630") or ("7689823") or ("7702592") or ("7515710") or ("6799165") or ("6385596") or ("5907617") or ("5903647") or ("5887060") or ("5883955") or ("5870543") or ("5883954") or ("7290699") or ("7340769") or ("7343014") or ("7386513") or ("7571328") or ("7624417") or ("20020010759") or ("20020157002") or ("20040024670") or ("20040062400") or ("20040162786") or ("20040220878") or ("20050066353") or ("20050182727") or ("20060173787") or ("20060173789") or ("20060259652") or ("20060259982") or ("20070055887") or ("20070156719") or ("20070179854") or ("20070180485") or ("20070250445") or	US-PGPUB; USPAT	OR	OFF	2012/05/07 13:55

EWS-003812

		("20080027869") or ("20080091606") or ("20080109911") or ("20080165956") or ("20090012805") or ("20090049556") or ("20090083541") or ("20090183010") or ("20090217036") or ("20090254930") or ("20090257591") or ("20090265278") or ("20090299963") or ("20090307078") or ("20090327702") or ("20090328228")).PN.				
S5	0	(("1505530A1") or ("1564621A1")).PN.	EPO; JPO; DERWENT; IBM_TDB	OR	OFF	2012/05/07 13:56
S6	11	(("1505530") or ("1564621")).PN.	EPO; JPO; DERWENT; IBM_TDB	OR	OFF	2012/05/07 13:56
S7	60	(("7266839") or ("7567987") or ("20070266095") or ("20090100060") or ("20070010334") or ("20060036554") or ("7634734") or ("20080111052") or ("20030018491") or ("7610630") or ("7689823") or ("7702592") or ("7515710") or ("6799165") or ("6385596") or ("5907617") or ("5903647") or ("5887060") or ("5883955") or ("5870543") or ("5883954") or ("7290699") or ("7340769") or ("7343014") or ("7386513") or ("7571328") or ("7624417") or ("20020010759") or ("20020157002") or ("20040024670") or ("20040062400") or ("20040162786") or ("20040220878") or ("20050066353") or ("20050182727") or ("20060173787") or ("20060173789") or ("20060259652") or ("20060259982") or ("20070055887") or ("20070156719") or ("20070179854") or ("20070180485") or ("20070250445") or ("20080027869") or ("20080091606") or ("20080109911") or ("20080165956") or ("20090012805") or ("20090049556") or ("20090083541") or ("20090183010") or ("20090217036") or	US-PGPUB; USPAT	OR	OFF	2012/05/07 15:06

EWS-003813

		("20090254930") or ("20090257591") or ("20090265278") or ("20090299963") or ("20090307078") or ("20090327702") or ("20090328228").PN.				
S8	0	S7 and ((DRM same ((many multi) near4 devices)) same (email\$3 with authenticat\$3 ))	US-PGPUB; USPAT; USOCR; FPRS; EPO; JPO; DERWENT; IBM_TDB	OR	OFF	2012/05/07 15:06
S9	0	S7 and ((DRM same ((many multi) near4 devices)) same (token ))	US-PGPUB; USPAT; USOCR; FPRS; EPO; JPO; DERWENT; IBM_TDB	OR	OFF	2012/05/07 15:07
S10	3	S7 and ((DRM same ((many multi) near4 devices)))	US-PGPUB; USPAT; USOCR; FPRS; EPO; JPO; DERWENT; IBM_TDB	OR	OFF	2012/05/07 15:07
S11	2	"20090210346"	US-PGPUB; USPAT; USOCR; FPRS; EPO; JPO; DERWENT; IBM_TDB	OR	OFF	2012/05/07 16:01
S12	8	(brand\$3 near2 request ) with (token meta ajd data) same encrypted	US-PGPUB; USPAT; USOCR; FPRS; EPO; JPO; DERWENT; IBM_TDB	OR	OFF	2012/05/07 16:44
S13	243	media with (interoperability inter-operability inter adj operability) and ((devices networks friends famil\$3) with ( sharing share\$1))	US-PGPUB; USPAT; USOCR; FPRS; EPO; JPO; DERWENT; IBM_TDB	OR	OFF	2012/05/07 16:49
S14	35	S13 and ("713" "726").clas.	US-PGPUB; USPAT; USOCR; FPRS; EPO; JPO; DERWENT; IBM_TDB	OR	OFF	2012/05/07 16:50
S15	0	((drm digital adj right) with ((different various many multi\$3) near3 (users clients pc hardware devices)) same (authenticat\$3 with (mac device adj (identification id)))	US-PGPUB; USPAT; USOCR; FPRS; EPO; JPO;	OR	OFF	2012/05/07 21:52

EWS-003814



		)	DERWENT; IBM_TDB			
S16	0	((drm digital adj right encrypted adj (media content)) with ((different various many multi\$3 near3 (users clients pc hardware devices)) same (authenticat\$3 with (mac device adj (identification id))) )	US-PGPUB; USPAT; USOCR; FPRS; EPO; JPO; DERWENT; IBM_TDB	OR	OFF	2012/05/07 21:53
S17	0	((drm digital adj right encrypted adj (media content)) same ((different various many multi\$3 near3 (users clients pc hardware devices)) same (authenticat\$3 with (mac device adj (identification id))) )	US-PGPUB; USPAT; USOCR; FPRS; EPO; JPO; DERWENT; IBM_TDB	OR	OFF	2012/05/07 21:53
S18	1	((drm digital adj right encrypted adj (media content)) same ((different various many multi\$3 shar\$3) with (users clients pc hardware devices)) same (authenticat\$3 with (mac device adj (identification id))) )	US-PGPUB; USPAT; USOCR; FPRS; EPO; JPO; DERWENT; IBM_TDB	OR	OFF	2012/05/07 21:54
S19	11	((drm digital adj right encrypted adj (media content)) and (brand\$3 near3 request\$3) )	US-PGPUB; USPAT; USOCR; FPRS; EPO; JPO; DERWENT; IBM_TDB	OR	OFF	2012/05/08 10:05
S20	0	((control\$4 access\$3 monitor\$3 ) with (encrypted adj (media content))) same ((different various many multi\$3 shar\$3) with (users clients pc hardware devices)) same (authenticat\$3 with (mac device adj (identification id))) ) .ab,bsum.	US-PGPUB; USPAT; USOCR; FPRS; EPO; JPO; DERWENT; IBM_TDB	OR	OFF	2012/05/08 10:52
S21	80	((control\$4 access\$3 monitor\$3 ) with (encrypted adj (media content))) same ((different various many multi\$3 shar\$3) with (users clients pc hardware devices)) ) .ab,bsum.	US-PGPUB; USPAT; USOCR; FPRS; EPO; JPO; DERWENT; IBM_TDB	OR	OFF	2012/05/08 10:53
S22	3	S21 and (authenticat\$3 with (mac device adj (identification id)))	US-PGPUB; USPAT; USOCR; FPRS; EPO; JPO; DERWENT; IBM_TDB	OR	OFF	2012/05/08 10:53
S23	5	S21 and (authenticat\$3 with (token mac device adj (identification id)))	US-PGPUB; USPAT; USOCR; FPRS; EPO; JPO; DERWENT; IBM_TDB	OR	OFF	2012/05/08 10:53
S24	33	S21 and (authenticat\$3 same (token mac device adj (identification id)))	US-PGPUB; USPAT; USOCR;	OR	OFF	2012/05/08 10:54

EWS-003815

			FPRS; EPO; JPO; DERWENT; IBM_TDB			
S25	11	(( (control\$4 access\$3 monitor\$3 ) with (encrypted adj (media content))) same ((different various many multi\$3 shar\$3) with (users clients pc hardware devices)) ).clm.	US-PGPUB; USPAT; USOCR; FPRS; EPO; JPO; DERWENT; IBM_TDB	OR	OFF	2012/05/08 10:54
S26	5622	(( (control\$4 access\$3 monitor\$3 ) with ((media content)) ) same ((different various many multi\$3 shar\$3) with (users clients pc hardware devices)) ) and (smart adj card smartcard token)	US-PGPUB; USPAT; USOCR; FPRS; EPO; JPO; DERWENT; IBM_TDB	OR	OFF	2012/05/08 12:11
S27	2	(request\$3 submit\$4 receiv\$3) same ((read\$3 writ\$3) with (meta\$4) with encrypt\$3 near3 (media content)) and ((digital adj right drm) same (shar\$3 interoperable interoperability inter adj operable inter adj operability))	US-PGPUB; USPAT; USOCR; FPRS; EPO; JPO; DERWENT; IBM_TDB	OR	OFF	2012/05/08 13:24
S28	14	(request\$3 submit\$4 receiv\$3) same ((read\$3 writ\$3) with (meta\$4) with (media content)) and ((digital adj right drm) same (shar\$3 interoperable interoperability inter adj operable inter adj operability))	US-PGPUB; USPAT; USOCR; FPRS; EPO; JPO; DERWENT; IBM_TDB	OR	OFF	2012/05/08 13:25
S29	2	S28 and (token smartcard smart adj card)	US-PGPUB; USPAT; USOCR; FPRS; EPO; JPO; DERWENT; IBM_TDB	OR	OFF	2012/05/08 13:25
S30	60	((("7266839") or ("7567987") or ("20070266095") or ("20090100060") or ("20070010334") or ("20060036554") or ("7634734") or ("20080111052") or ("20030018491") or ("7610630") or ("7689823") or ("7702592") or ("7515710") or ("6799165") or ("6385596") or ("5907617") or ("5903647") or ("5887060") or ("5883955") or ("5870543") or ("5883954") or ("7290699") or ("7340769") or ("7343014") or ("7386513") or ("7571328") or ("7624417") or ("20020010759") or ("20020157002") or ("20040024670") or ("20040062400") or ("20040162786") or ("20040220878") or ("20050066353") or ("20050182727") or	US-PGPUB; USPAT	OR	OFF	2012/05/08 15:27

EWS-003816

		("20060173787") or ("20060173789") or ("20060259652") or ("20060259982") or ("20070055887") or ("20070156719") or ("20070179854") or ("20070180485") or ("20070250445") or ("20080027869") or ("20080091606") or ("20080109911") or ("20080165956") or ("20090012805") or ("20090049556") or ("20090083541") or ("20090183010") or ("20090217036") or ("20090254930") or ("20090257591") or ("20090265278") or ("20090299963") or ("20090307078") or ("20090327702") or ("20090328228").PN.				
S31	41	S30 and (token smartcard smart adj card sim subscriber adj identity adj module )	US-PGPUB; USPAT; USOCR; FPRS; EPO; JPO; DERWENT; IBM_TDB	OR	OFF	2012/05/08 15:27
S32	15	S31 and meta\$4	US-PGPUB; USPAT; USOCR; FPRS; EPO; JPO; DERWENT; IBM_TDB	OR	OFF	2012/05/08 15:28
S33	0	S32 and (writ\$3 overwrit\$3 wrote) with meta\$4	US-PGPUB; USPAT; USOCR; FPRS; EPO; JPO; DERWENT; IBM_TDB	OR	OFF	2012/05/08 15:51
S34	1488	(drm rights management digital adj (media content)) same (writ\$3 overwrit\$3 wrote) with meta\$4	US-PGPUB; USPAT; USOCR; FPRS; EPO; JPO; DERWENT; IBM_TDB	OR	OFF	2012/05/08 15:52
S35	127	S34 and ("713" "726").clas.	US-PGPUB; USPAT; USOCR; FPRS; EPO; JPO; DERWENT; IBM_TDB	OR	OFF	2012/05/08 15:53
S36	41	S35 and (token smartcard smart adj card sim subscriber adj identity adj	US-PGPUB; USPAT;	OR	OFF	2012/05/08 15:53

EWS-003817

		module )	USOCR; FPRS; EPO; JPO; DERWENT; IBM_TDB			
S37	2	"20100131346"	US-PGPUB; USPAT; USOCR; FPRS; EPO; JPO; DERWENT; IBM_TDB	OR	OFF	2012/05/08 16:46
S38	5	"2005065891"	US-PGPUB; USPAT; USOCR; FPRS; EPO; JPO; DERWENT; IBM_TDB	OR	OFF	2012/05/09 10:13
S39	2	"20050065891"	US-PGPUB; USPAT; USOCR; FPRS; EPO; JPO; DERWENT; IBM_TDB	OR	OFF	2012/05/09 10:13
S40	3	"20060277598"	US-PGPUB; USPAT; USOCR; FPRS; EPO; JPO; DERWENT; IBM_TDB	OR	OFF	2012/05/09 10:25
S41	60	(("7266839") or ("7567987") or ("20070266095") or ("20090100060") or ("20070010334") or ("20060036554") or ("7634734") or ("20080111052") or ("20030018491") or ("7610630") or ("7689823") or ("7702592") or ("7515710") or ("6799165") or ("6385596") or ("5907617") or ("5903647") or ("5887060") or ("5883955") or ("5870543") or ("5883954") or ("7290699") or ("7340769") or ("7343014") or ("7386513") or ("7571328") or ("7624417") or ("20020010759") or ("20020157002") or ("20040024670") or ("20040062400") or ("20040162786") or ("20040220878") or ("20050066353") or ("20050182727") or ("20060173787") or ("20060173789") or ("20060259652") or ("20060259982") or ("20070055887") or ("20070156719") or	US-PGPUB; USPAT	OR	OFF	2012/05/09 10:53

EWS-003818

		("20070179854") or ("20070180485") or ("20070250445") or ("20080027869") or ("20080091606") or ("20080109911") or ("20080165956") or ("20090012805") or ("20090049556") or ("20090083541") or ("20090183010") or ("20090217036") or ("20090254930") or ("20090257591") or ("20090265278") or ("20090299963") or ("20090307078") or ("20090327702") or ("20090328228").PN.				
S42	41	S41 and (key adj fob token smartcard smart adj card sim subscriber adj identity adj module )	US-PGPUB; USPAT; USOCR; FPRS; EPO; JPO; DERWENT; IBM_TDB	OR	OFF	2012/05/09 10:53
S43	1491	(drm rights management (encrypt\$3 digital) adj (media content)) same (writ\$3 overwrit\$3 wrote) with meta\$4	US-PGPUB; USPAT; USOCR; FPRS; EPO; JPO; DERWENT; IBM_TDB	OR	OFF	2012/05/09 10:54
S44	282	S43 and (request\$3 log\$4) with (key fob token smart adj card)	US-PGPUB; USPAT; USOCR; FPRS; EPO; JPO; DERWENT; IBM_TDB	OR	OFF	2012/05/09 10:54
S45	57	S44 and ("713" "726").clas.	US-PGPUB; USPAT; USOCR; FPRS; EPO; JPO; DERWENT; IBM_TDB	OR	OFF	2012/05/09 10:55
S46	1713	(drm digital adj right\$1 rights adj management (encrypt\$3 digital) adj (media content)) same (writ\$3 overwrit\$3 wrote) with meta\$4	US-PGPUB; USPAT; USOCR; FPRS; EPO; JPO; DERWENT; IBM_TDB	OR	OFF	2012/05/09 10:58
S47	186	S46 and (request\$3 log\$4) with (key fob token smart adj card)	US-PGPUB; USPAT; USOCR; FPRS; EPO; JPO; DERWENT; IBM_TDB	OR	OFF	2012/05/09 10:58
S48	44	S47 and ("713" "726").clas.	US-PGPUB;	OR	OFF	2012/05/09

EWS-003819

			USPAT; USOCR; FPRS; EPO; JPO; DERWENT; IBM_TDB			10:58
S49	178	(drm digital adj right\$1 rights adj management (encrypt\$3 digital) adj (media content)) same (writ\$3 overwrit\$3 wrote) with meta\$4	US-PGPUB; USPAT; USOCR; FPRS; EPO; JPO; DERWENT; IBM_TDB	OR	OFF	2012/05/09 10:59
S50	91	S49 and (request\$3 log\$4) with (key fob token smart adj card)	US-PGPUB; USPAT; USOCR; FPRS; EPO; JPO; DERWENT; IBM_TDB	OR	OFF	2012/05/09 10:59
S51	28	S50 and ("713" "726").clas.	US-PGPUB; USPAT; USOCR; FPRS; EPO; JPO; DERWENT; IBM_TDB	OR	OFF	2012/05/09 10:59
S52	14884	(drm digital adj right\$1 rights adj management (encrypt\$3 digital) adj (media content)) same (key fob token smart adj card)	US-PGPUB; USPAT; USOCR; FPRS; EPO; JPO; DERWENT; IBM_TDB	OR	OFF	2012/05/09 11:08
S53	4816	S52 and ("713" "726").clas.	US-PGPUB; USPAT; USOCR; FPRS; EPO; JPO; DERWENT; IBM_TDB	OR	OFF	2012/05/09 11:08
S54	1872	S52 and 713/155-159,168,172-176,182,189.ccls.	US-PGPUB; USPAT; USOCR; FPRS; EPO; JPO; DERWENT; IBM_TDB	OR	OFF	2012/05/09 11:10
S55	424	S54 and ((all various every plural\$4 many multi\$3 different ) adj2 devices)	US-PGPUB; USPAT; USOCR; FPRS; EPO; JPO; DERWENT; IBM_TDB	OR	OFF	2012/05/09 11:11
S56	74	S55 and (application adj interface api)	US-PGPUB; USPAT; USOCR; FPRS; EPO; JPO; DERWENT;	OR	OFF	2012/05/09 11:11

EWS-003820

			IBM_TDB			
S57	1198	S53 and ((all various every plural\$4 many multi\$3 different ) adj2 devices)	US-PGPUB; USPAT; USOCR; FPRS; EPO; JPO; DERWENT; IBM_TDB	OR	OFF	2012/05/09 11:41
S58	66	S57 and ((read\$3 writ\$3 updat\$) with meta\$4)	US-PGPUB; USPAT; USOCR; FPRS; EPO; JPO; DERWENT; IBM_TDB	OR	OFF	2012/05/09 11:42
S59	43	((request\$3 permission ask\$3 query\$3) with (read writ\$3 updat\$3 modif\$3) with meta\$4) same (drm digital adj right\$1 media adj content encrypted adj media)	US-PGPUB; USPAT; USOCR; FPRS; EPO; JPO; DERWENT; IBM_TDB	OR	OFF	2012/05/09 12:42
S60	0	S59 and (authentikat\$3 verif\$3 verification) with (token smart adj card fob)	US-PGPUB; USPAT; USOCR; FPRS; EPO; JPO; DERWENT; IBM_TDB	OR	OFF	2012/05/09 12:43
S61	2	S59 and (token smart adj card fob)	US-PGPUB; USPAT; USOCR; FPRS; EPO; JPO; DERWENT; IBM_TDB	OR	OFF	2012/05/09 12:44
S62	2	S59 and 713/155-159,168,172-176,182,189.ccls.	US-PGPUB; USPAT; USOCR; FPRS; EPO; JPO; DERWENT; IBM_TDB	OR	OFF	2012/05/09 12:46
S63	92781	26and ("713" "726").clas.	US-PGPUB; USPAT; USOCR; FPRS; EPO; JPO; DERWENT; IBM_TDB	OR	OFF	2012/05/09 12:49
S64	5	S59 and ("713" "726").clas.	US-PGPUB; USPAT; USOCR; FPRS; EPO; JPO; DERWENT; IBM_TDB	OR	OFF	2012/05/09 12:49
S65	2	S59 and (user adj key token smart adj card fob)	US-PGPUB; USPAT; USOCR; FPRS;	OR	OFF	2012/05/09 13:01

EWS-003821

			EPO; JPO; DERWENT; IBM_TDB			
S66	66	((request\$3 permission ask\$3 query\$3 permit\$4 allow\$3) with (read writ\$3 updat\$3 modif\$3) with meta\$4) same (drm digital adj right\$1 media adj content encrypted adj media)	US-PGPUB; USPAT; USOCR; FPRS; EPO; JPO; DERWENT; IBM_TDB	OR	OFF	2012/05/09 13:02
S67	70235	"36" and (user adj key token smart adj card fob)	US-PGPUB; USPAT; USOCR; FPRS; EPO; JPO; DERWENT; IBM_TDB	OR	OFF	2012/05/09 13:03
S68	4	S66 and (user adj key token smart adj card fob)	US-PGPUB; USPAT; USOCR; FPRS; EPO; JPO; DERWENT; IBM_TDB	OR	OFF	2012/05/09 13:03
S69	0	((web near3 account) same ((two adj way) exchange) with authenticat\$3) same (drm digital adj right\$1 media adj content encrypted adj media)	US-PGPUB; USPAT; USOCR; FPRS; EPO; JPO; DERWENT; IBM_TDB	OR	OFF	2012/05/09 17:11
S70	8731	((web near3 account) same (((two adj way) exchange) with authenticat\$3) key ajd exchange ake ) same (drm digital adj right\$1 media adj content encrypted adj media)	US-PGPUB; USPAT; USOCR; FPRS; EPO; JPO; DERWENT; IBM_TDB	OR	OFF	2012/05/09 17:15
S71	185	((web near3 account) same (((two adj way) exchange) with authenticat\$3) key adj exchange ake ) same (drm digital adj right\$1 media adj content encrypted adj media)	US-PGPUB; USPAT; USOCR; FPRS; EPO; JPO; DERWENT; IBM_TDB	OR	OFF	2012/05/09 17:15
S72	62	S71 and ("713" "726").clas.	US-PGPUB; USPAT; USOCR; FPRS; EPO; JPO; DERWENT; IBM_TDB	OR	OFF	2012/05/09 17:16
S73	5	S72 and (api application adj interface)	US-PGPUB; USPAT; USOCR; FPRS; EPO; JPO; DERWENT; IBM_TDB	OR	OFF	2012/05/09 17:17
S74	12	(web adj (service account) with (key data) near2 exchange) and (DRm	US-PGPUB; USPAT;	OR	OFF	2012/05/09 17:34

EWS-003822



		digital adj right\$1 encrypted adj (media content)	USOCR; FPRS; EPO; JPO; DERWENT; IBM_TDB			
S75	2	(web adj (service account) with (key data) near2 exchange) same (verifi\$3 verification) and (DRm digital adj right\$1 encrypted adj (media content))	US-PGPUB; USPAT; USOCR; FPRS; EPO; JPO; DERWENT; IBM_TDB	OR	OFF	2012/05/09 18:26
S76	2	(web adj (service account) same (key data) near2 exchange) same (verifi\$3 verification) and (DRm digital adj right\$1 encrypted adj (media content))	US-PGPUB; USPAT; USOCR; FPRS; EPO; JPO; DERWENT; IBM_TDB	OR	OFF	2012/05/09 18:26
S77	44	(web adj (service account) same (key data) near2 exchange) same (verifi\$3 verification authenticat\$3 authentication)	US-PGPUB; USPAT; USOCR; FPRS; EPO; JPO; DERWENT; IBM_TDB	OR	OFF	2012/05/09 22:27
S78	14	S77 and ("713" "726").clas.	US-PGPUB; USPAT; USOCR; FPRS; EPO; JPO; DERWENT; IBM_TDB	OR	OFF	2012/05/09 22:27
S79	2139	(id identificaTION identif\$3) with (account\$1) and (drm digital adj right\$1)	US-PGPUB; USPAT; USOCR; FPRS; EPO; JPO; DERWENT; IBM_TDB	OR	OFF	2012/05/13 20:15
S80	479	S79 and ("713" "726").clas.	US-PGPUB; USPAT; USOCR; FPRS; EPO; JPO; DERWENT; IBM_TDB	OR	OFF	2012/05/13 20:15
S81	134	S80 and (ike ake key adj exchang\$3 data adj exchang\$3)	US-PGPUB; USPAT; USOCR; FPRS; EPO; JPO; DERWENT; IBM_TDB	OR	OFF	2012/05/13 20:16
S82	58	S80 and (ike ake key adj exchang\$3)	US-PGPUB; USPAT; USOCR; FPRS; EPO; JPO; DERWENT; IBM_TDB	OR	OFF	2012/05/13 20:16

EWS-003823

S83	3285241	(user client) near4 customiz\$3 modif\$3 (display screen panel) same (encrypted adj2 (digital media))	US-PGPUB; USPAT; USOCR; FPRS; EPO; JPO; DERWENT; IBM_TDB	OR	OFF	2012/05/13 20:18
S84	2	(user client) near4 (customiz\$3 modif\$3) with (display screen panel) same (encrypted adj2 (digital media))	US-PGPUB; USPAT; USOCR; FPRS; EPO; JPO; DERWENT; IBM_TDB	OR	OFF	2012/05/13 20:19
S85	36294	(user client) near4 (customiz\$3 modif\$3) same (display screen panel)	US-PGPUB; USPAT; USOCR; FPRS; EPO; JPO; DERWENT; IBM_TDB	OR	OFF	2012/05/13 20:20
S86	17102	(user client) near4 (customiz\$3 modif\$3) with (display screen panel)	US-PGPUB; USPAT; USOCR; FPRS; EPO; JPO; DERWENT; IBM_TDB	OR	OFF	2012/05/13 20:20
S87	622	S86 and ("713" "726").clas.	US-PGPUB; USPAT; USOCR; FPRS; EPO; JPO; DERWENT; IBM_TDB	OR	OFF	2012/05/13 20:21
S88	16	S87 and (drm digital adj right)	US-PGPUB; USPAT; USOCR; FPRS; EPO; JPO; DERWENT; IBM_TDB	OR	OFF	2012/05/13 20:21
S89	114	S87 and 713/155-159,168,172- 176,182,189.ccls.	US-PGPUB; USPAT; USOCR; FPRS; EPO; JPO; DERWENT; IBM_TDB	OR	OFF	2012/05/13 20:56
S90	11	S89 and (encrypted adj2 (digital media))	US-PGPUB; USPAT; USOCR; FPRS; EPO; JPO; DERWENT; IBM_TDB	OR	OFF	2012/05/13 20:57
S91	140	S87 and 726/22-32.ccls.	US-PGPUB; USPAT; USOCR; FPRS; EPO; JPO;	OR	OFF	2012/05/13 21:19

EWS-003824

			DERWENT; IBM_TDB			
S92	12	S91 and (encrypted adj2 (digital media))	US-PGPUB; USPAT; USOCR; FPRS; EPO; JPO; DERWENT; IBM_TDB	OR	OFF	2012/05/13 21:19
S93	250	S87 and 726/7-32.ccls.	US-PGPUB; USPAT; USOCR; FPRS; EPO; JPO; DERWENT; IBM_TDB	OR	OFF	2012/05/13 21:22
S94	15	S93 and (encrypted adj2 (digital media))	US-PGPUB; USPAT; USOCR; FPRS; EPO; JPO; DERWENT; IBM_TDB	OR	OFF	2012/05/13 21:23
S95	3	S94 not S92	US-PGPUB; USPAT; USOCR; FPRS; EPO; JPO; DERWENT; IBM_TDB	OR	OFF	2012/05/13 21:23
S96	2	"20100100899"	US-PGPUB; USPAT; USOCR; FPRS; EPO; JPO; DERWENT; IBM_TDB	OR	OFF	2012/05/13 21:46
S97	17102	(user client) near4 (customiz\$3 modif\$3) with (display screen panel)	US-PGPUB; USPAT; USOCR; FPRS; EPO; JPO; DERWENT; IBM_TDB	OR	OFF	2012/05/14 11:29
S98	622	S97 and ("713" "726").clas.	US-PGPUB; USPAT; USOCR; FPRS; EPO; JPO; DERWENT; IBM_TDB	OR	OFF	2012/05/14 11:29
S99	250	S98 and 726/7-32.ccls.	US-PGPUB; USPAT; USOCR; FPRS; EPO; JPO; DERWENT; IBM_TDB	OR	OFF	2012/05/14 11:29
S100	30	S99 and (encrypted adj2 (digital media) digital adj (media content))	US-PGPUB; USPAT; USOCR;	OR	OFF	2012/05/14 11:29

EWS-003825

			FPRS; EPO; JPO; DERWENT; IBM_TDB			
S101	53	S98 and (encrypted adj2 (digital media) digital adj (media content))	US-PGPUB; USPAT; USOCR; FPRS; EPO; JPO; DERWENT; IBM_TDB	OR	OFF	2012/05/14 11:35
S102	8	(updat\$3 read\$3 writ\$3 modif\$3) with brand\$3 with (meta metadata meta-data).ab,clm,ti.	US-PGPUB; USPAT; USOCR; FPRS; EPO; JPO; DERWENT; IBM_TDB	OR	OFF	2012/05/17 10:54
S103	2	"7526650"	US-PGPUB; USPAT; USOCR; FPRS; EPO; JPO; DERWENT; IBM_TDB	OR	OFF	2012/05/21 13:47
S104	15144386	"20120030291" "20120124612" "20120124613" "20120124611" "20120124614" "20120124610" "7" "20120124678"	US-PGPUB; USPAT; USOCR; FPRS; EPO; JPO; DERWENT; IBM_TDB	OR	OFF	2012/10/01 12:55
S105	14	"20120030291" "20120124612" "20120124613" "20120124611" "20120124614" "20120124610" "20120124678"	US-PGPUB; USPAT; USOCR; FPRS; EPO; JPO; DERWENT; IBM_TDB	OR	OFF	2012/10/01 12:56
S106	17	(digital adj media with (sharing interoperability)) same (cloud vendors universal)	US-PGPUB; USPAT; USOCR; FPRS; EPO; JPO; DERWENT; IBM_TDB	OR	OFF	2012/10/01 15:21
S107	43	(digital adj media with (sharing interoperability)) same (metadata meta-data meta adj data)	US-PGPUB; USPAT; USOCR; FPRS; EPO; JPO; DERWENT; IBM_TDB	OR	OFF	2012/10/01 15:25
S108	154	(writ\$3 request modif\$3) with (metadata meta-data meta adj data) same (digital adj media)	US-PGPUB; USPAT; USOCR; FPRS; EPO; JPO; DERWENT; IBM_TDB	OR	OFF	2012/10/01 15:45
S109	2	S108 and ((digital adj media	US-PGPUB;	OR	OFF	2012/10/01

EWS-003826

		same(sharing interoperability)) same (cloud vendors universal))	USPAT; USOCR; FPRS; EPO; JPO; DERWENT; IBM_TDB			15:46
S110	8	((writ\$3 request modif\$3 add\$3 attach\$3) near4 (membership identity right authorization authorized ID)) with (metadata meta-data meta adj data) ) same (digital adj media)	US-PGPUB; USPAT; USOCR; FPRS; EPO; JPO; DERWENT; IBM_TDB	OR	OFF	2012/10/02 10:35
S111	79	((writ\$3 request modif\$3 add\$3 attach\$3 read\$3 includ\$3) with (verification verif\$4 membership identity right authorization authorized ID)) with (metadata metadata meta adj data) ) same (digital adj media)	US-PGPUB; USPAT; USOCR; FPRS; EPO; JPO; DERWENT; IBM_TDB	OR	OFF	2012/10/02 11:07
S112	71	S111 not S110	US-PGPUB; USPAT; USOCR; FPRS; EPO; JPO; DERWENT; IBM_TDB	OR	OFF	2012/10/02 11:07
S113	19	S112 and unlimit\$3	US-PGPUB; USPAT; USOCR; FPRS; EPO; JPO; DERWENT; IBM_TDB	OR	OFF	2012/10/02 11:31
S114	0	S112 and interoperabilty	US-PGPUB; USPAT; USOCR; FPRS; EPO; JPO; DERWENT; IBM_TDB	OR	OFF	2012/10/02 11:56
S115	10	((shar\$3 device adj (id identification) address mac password serial key) with (token verification verif\$4 membership identity right authorization authorized ID)) with (metadata metadata meta adj data) ) same (digital adj media)	US-PGPUB; USPAT; USOCR; FPRS; EPO; JPO; DERWENT; IBM_TDB	OR	OFF	2012/10/02 15:34
S116	1	"12982378"	US-PGPUB; USPAT; USOCR; FPRS; EPO; JPO; DERWENT; IBM_TDB	OR	OFF	2012/10/03 17:05
S117	0	"20100100899" and (right\$1 with meta)	US-PGPUB; USPAT; USOCR; FPRS; EPO; JPO; DERWENT;	OR	ON	2012/10/30 21:42

EWS-003827

			IBM_TDB			
S118	1	"20100100899" and (right\$1 with metadata)	US-PGPUB; USPAT; USOCR; FPRS; EPO; JPO; DERWENT; IBM_TDB	OR	ON	2012/10/30 21:43
S120	1	"20110288946" and (key\$1 with metadata)	US-PGPUB; USPAT; USOCR; FPRS; EPO; JPO; DERWENT; IBM_TDB	OR	ON	2012/10/31 15:29
S121	1	"61307196"	US-PGPUB; USPAT; USOCR; FPRS; EPO; JPO; DERWENT; IBM_TDB	OR	ON	2012/11/05 10:26
S122	154	((writ\$3 request modif\$3) with (metadata meta-data meta adj data) same (digital adj media)	US-PGPUB; USPAT; USOCR; FPRS; EPO; JPO; DERWENT; IBM_TDB	OR	OFF	2012/11/14 17:55
S123	82	(( ((writ\$3 request modif\$3 add\$3 attach\$3 read\$3 includ\$3) with (verification verif\$4 membership identity right authorization authorized ID)) with (metadata metadata meta adj data) ) same (digital adj media)	US-PGPUB; USPAT; USOCR; FPRS; EPO; JPO; DERWENT; IBM_TDB	OR	OFF	2012/11/14 17:57
S124	3	((identifier with (cross-referenc\$3 cross) with token ) and ( digital adj (media content) DRM)	US-PGPUB; USPAT; USOCR; FPRS; EPO; JPO; DERWENT; IBM_TDB	OR	OFF	2012/11/15 15:56
S125	19452	((device\$1 right\$1 near object\$1) with (identification identif\$4)) same shar\$3	US-PGPUB; USPAT; USOCR; FPRS; EPO; JPO; DERWENT; IBM_TDB	OR	OFF	2013/01/16 12:33
S126	8704	((device\$1 right\$1 near object\$1) with (identification identif\$4)) with shar\$3	US-PGPUB; USPAT; USOCR; FPRS; EPO; JPO; DERWENT; IBM_TDB	OR	OFF	2013/01/16 12:34
S127	5292	((device\$1 right\$1 near object\$1) near5 (identification identif\$4)) with shar\$3	US-PGPUB; USPAT; USOCR; FPRS;	OR	OFF	2013/01/16 12:34

EWS-003828

			EPO; JPO; DERWENT; IBM_TDB			
S128	3921	((device\$1 right\$1 near object\$1) near3 (identification identif\$4)) with shar\$3	US-PGPUB; USPAT; USOCR; FPRS; EPO; JPO; DERWENT; IBM_TDB	OR	OFF	2013/01/16 12:34
S129	292	S128 and "726".clas.	US-PGPUB; USPAT; USOCR; FPRS; EPO; JPO; DERWENT; IBM_TDB	OR	OFF	2013/01/16 12:34
S130	174	S128 and 726/7-32.ccls.	US-PGPUB; USPAT; USOCR; FPRS; EPO; JPO; DERWENT; IBM_TDB	OR	OFF	2013/01/16 12:35
S131	19	((shar\$3 device adj (id identification) address mac password serial key) with (token verification verif\$4 membership identity right authorization authorized ID)) with (metadata metadata meta adj data) ) same (digital adj media)	US-PGPUB; USPAT; USOCR; FPRS; EPO; JPO; DERWENT; IBM_TDB	OR	ON	2013/01/16 12:40
S132	10	((shar\$3 device adj (id identification) address mac password serial key) with (token verification verif\$4 membership identity right authorization authorized ID)) with (metadata metadata meta adj data) ) same (digital adj media)	US-PGPUB; USPAT; USOCR; FPRS; EPO; JPO; DERWENT; IBM_TDB	OR	OFF	2013/01/16 12:52
S133	9	S131 not S132	US-PGPUB; USPAT; USOCR; FPRS; EPO; JPO; DERWENT; IBM_TDB	OR	ON	2013/01/16 12:52
S134	3	"7526650"	US-PGPUB; USPAT; USOCR; FPRS; EPO; JPO; DERWENT; IBM_TDB	OR	OFF	2013/01/16 14:49
S135	31	((shar\$3 device adj (id identification) address mac password serial key) with (token verification verif\$4 membership identity right authorization authorized ID)) with (metadata metadata meta adj data) ) same (digital adj media right adj object)	US-PGPUB; USPAT; USOCR; FPRS; EPO; JPO; DERWENT; IBM_TDB	OR	ON	2013/01/17 14:42
S136	3	"20060161635"	US-PGPUB;	OR	ON	2013/01/17

EWS-003829

			USPAT; USOCR; FPRS; EPO; JPO; DERWENT; IBM_TDB			14:43
S137	3	"20020107803"	US-PGPUB; USPAT; USOCR; FPRS; EPO; JPO; DERWENT; IBM_TDB	OR	ON	2013/01/17 14:43

5/19/2013 9:14:49 PM

C:\Users\ttran14\Documents\EAST\Workspaces\13740086.wsp



<b>Index of Claims</b>  	<b>Application/Control No.</b>  13740086	<b>Applicant(s)/Patent Under Reexamination</b>  GRECIA, WILLIAM
	<b>Examiner</b>  TRI TRAN	<b>Art Unit</b>  2494

✓	<b>Rejected</b>
=	<b>Allowed</b>

-	<b>Cancelled</b>
÷	<b>Restricted</b>

N	<b>Non-Elected</b>
I	<b>Interference</b>

A	<b>Appeal</b>
O	<b>Objected</b>

Claims renumbered in the same order as presented by applicant
  CPA
  T.D.
  R.1.47

CLAIM		DATE							
Final	Original	05/14/2013							
	1	=							
	2	=							
	3	=							
	4	=							
	5	=							
	6	=							
	7	=							
	8	=							
	9	=							
	10	=							
	11	=							
	12	=							
	13	=							
	14	=							
	15	=							
	16	=							
	17	=							
	18	=							
	19	=							
	20	=							
	21	=							
	22	=							
	23	=							
	24	=							
	25	=							
	26	=							
	27	=							
	28	=							
	29	=							
	30	=							

**PART B - FEE(S) TRANSMITTAL**

**Complete and send this form, together with applicable fee(s), to: Mail Mail Stop ISSUE FEE  
 Commissioner for Patents  
 P.O. Box 1450  
 Alexandria, Virginia 22313-1450  
 or Fax (571)-273-2885**

**INSTRUCTIONS:** This form should be used for transmitting the ISSUE FEE and PUBLICATION FEE (if required). Blocks 1 through 5 should be completed where appropriate. All further correspondence including the Patent, advance orders and notification of maintenance fees will be mailed to the current correspondence address as indicated unless corrected below or directed otherwise in Block 1, by (a) specifying a new correspondence address; and/or (b) indicating a separate "FEE ADDRESS" for maintenance fee notifications.

CURRENT CORRESPONDENCE ADDRESS (Note: Use Block 1 for any change of address)

Note: A certificate of mailing can only be used for domestic mailings of the Fee(s) Transmittal. This certificate cannot be used for any other accompanying papers. Each additional paper, such as an assignment or formal drawing, must have its own certificate of mailing or transmission.

70984 7590 05/31/2013  
**The STR3EM Team**  
 2885 Sanford Ave SW #13208  
 Grandville, MI 49418

**Certificate of Mailing or Transmission**

I hereby certify that this Fee(s) Transmittal is being deposited with the United States Postal Service with sufficient postage for first class mail in an envelope addressed to the Mail Stop ISSUE FEE address above, or being facsimile transmitted to the USPTO (571) 273-2885, on the date indicated below.

(Depositor's name)
(Signature)
(Date)

APPLICATION NO.	FILING DATE	FIRST NAMED INVENTOR	ATTORNEY DOCKET NO.	CONFIRMATION NO.
13/740,086	01/11/2013	William Grecia		7081

TITLE OF INVENTION: PERSONALIZED DIGITAL MEDIA ACCESS SYSTEM - PDMAS PART II

APPLN. TYPE	ENTITY STATUS	ISSUE FEE DUE	PUBLICATION FEE DUE	PREV. PAID ISSUE FEE	TOTAL FEE(S) DUE	DATE DUE
nonprovisional	SMALL	\$890	\$0	\$0	\$890	09/03/2013

EXAMINER	ART UNIT	CLASS-SUBCLASS
TRAN, TRI MINH	2494	726-010000

<p>1. Change of correspondence address or indication of "Fee Address" (37 CFR 1.363).</p> <p><input type="checkbox"/> Change of correspondence address (or Change of Correspondence Address form PTO/SB/122) attached.</p> <p><input type="checkbox"/> "Fee Address" indication (or "Fee Address" Indication form PTO/SB/47; Rev 03-02 or more recent) attached. <b>Use of a Customer Number is required.</b></p>	<p>2. For printing on the patent front page, list</p> <p>(1) the names of up to 3 registered patent attorneys or agents OR, alternatively, 1 _____</p> <p>(2) the name of a single firm (having as a member a registered attorney or agent) and the names of up to 2 registered patent attorneys or agents. If no name is listed, no name will be printed. 2 _____</p> <p>3 _____</p>
---	---

3. ASSIGNEE NAME AND RESIDENCE DATA TO BE PRINTED ON THE PATENT (print or type)

PLEASE NOTE: Unless an assignee is identified below, no assignee data will appear on the patent. If an assignee is identified below, the document has been filed for recordation as set forth in 37 CFR 3.11. Completion of this form is NOT a substitute for filing an assignment.

(A) NAME OF ASSIGNEE \_\_\_\_\_ (B) RESIDENCE: (CITY and STATE OR COUNTRY) \_\_\_\_\_

Please check the appropriate assignee category or categories (will not be printed on the patent) :  Individual  Corporation or other private group entity  Government

<p>4a. The following fee(s) are submitted:</p> <p><input checked="" type="checkbox"/> Issue Fee</p> <p><input type="checkbox"/> Publication Fee (No small entity discount permitted)</p> <p><input type="checkbox"/> Advance Order - # of Copies _____</p>	<p>4b. Payment of Fee(s): (<b>Please first reapply any previously paid issue fee shown above</b>)</p> <p><input type="checkbox"/> A check is enclosed.</p> <p><input type="checkbox"/> Payment by credit card. Form PTO-2038 is attached.</p> <p><input type="checkbox"/> The Director is hereby authorized to charge the required fee(s), any deficiency, or credit any overpayment, to Deposit Account Number _____ (enclose an extra copy of this form).</p>
--	---

5. **Change in Entity Status** (from status indicated above)

Applicant certifying micro entity status. See 37 CFR 1.29

NOTE: Absent a valid certification of Micro Entity Status (see form PTO/SB/15A and 15B), issue fee payment in the micro entity amount will not be accepted at the risk of application abandonment.

Applicant asserting small entity status. See 37 CFR 1.27

NOTE: If the application was previously under micro entity status, checking this box will be taken to be a notification of loss of entitlement to micro entity status.

Applicant changing to regular undiscounted fee status.

NOTE: Checking this box will be taken to be a notification of loss of entitlement to small or micro entity status, as applicable.

---

NOTE: The Issue Fee and Publication Fee (if required) will not be accepted from anyone other than the applicant; a registered attorney or agent; or the assignee or other party in interest as shown by the records of the United States Patent and Trademark Office.

---

Authorized Signature /william grecia/

Date 5/31/2013

Typed or printed name William Grecia

Registration No. 70984

---

This collection of information is required by 37 CFR 1.311. The information is required to obtain or retain a benefit by the public which is to file (and by the USPTO to process) an application. Confidentiality is governed by 35 U.S.C. 122 and 37 CFR 1.14. This collection is estimated to take 12 minutes to complete, including gathering, preparing, and submitting the completed application form to the USPTO. Time will vary depending upon the individual case. Any comments on the amount of time you require to complete this form and/or suggestions for reducing this burden, should be sent to the Chief Information Officer, U.S. Patent and Trademark Office, U.S. Department of Commerce, P.O. Box 1450, Alexandria, Virginia 22313-1450. DO NOT SEND FEES OR COMPLETED FORMS TO THIS ADDRESS. SEND TO: Commissioner for Patents, P.O. Box 1450, Alexandria, Virginia 22313-1450.

Under the Paperwork Reduction Act of 1995, no persons are required to respond to a collection of information unless it displays a valid OMB control number.

---

IN THE UNITED STATES PATENT AND TRADEMARK OFFICE

In re application of:

William Grecia

Application No.: 13/740,086

Filed: January 11, 2013

For: PERSONALIZED DIGITAL MEDIA

ACCESS SYSTEM – PDMAS PART II

Examiner: Tran, Tri Minh

Art Unit: 2494

CNF# 6106

**AMENDMENT UNDER 37 C.F.R. 1.312**

Assistant Commissioner for Patents

P. O. Box 1450

Alexandria VA, 22313-1450

Sir:

To correct formalities, please amend the above-identified application as follows:

IN THE CLAIMS

Please amend all claims labeled as (Currently Amended). All claims are reproduced starting on page 2 of this document for convenient reference. No new matter has been added by way of this amendment and requires no substantial amount of additional work on the part of the office.

Respectfully Submitted,

/william grecia/

William Grecia

Applicant Pro Se

Claims:

1. (Currently amended) A method for authorizing ~~monitoring access to~~ digital content ~~an internet-connected data source~~ using a cloud system, the cloud system comprising connected modules in operation as one or more of a cloud computing or a cloud storage in connection with devices and users, wherein the digital content ~~internet-connected data source~~ comprises one or more of a machine, video, audio, container, format, document, credit card information, personal information, textual information, image, advertisement, logo, tag, message, URL, video game, software, downloadable program, content provider, service provider, or other computer-based apparatus in which ~~processed data is facilitated, the data being~~ is at least one of encrypted or not encrypted, the method facilitating access rights between a plurality of data processing devices, the method comprising:

receiving ~~[[the]]~~ a digital content ~~internet-connected data source~~ access request from at least one communications console of the plurality of data processing devices, the access request being a read or write request of metadata of the digital content ~~internet-connected data source~~, wherein the read or write request of metadata is performed in connection with a combination of at least one device and the cloud system, the request comprising a verification token provided by a first user corresponding to the digital content ~~internet-connected data source~~, wherein the verification token is one or more of a password, e-mail address, payment system, credit card, authorize ready device, rights token, or one or more redeemable instruments of trade;

authenticating the verification token;

establishing a connection with the at least one communications console, wherein the communications console is a combination of a graphic user interface (GUI) and an Application[[s]] Programmable Interface (API) wherein the API is obtained from a verified web service, the web service capable of facilitating a two way data exchange to complete a verification process wherein the data exchange session comprises at least one reference;

requesting at least one identification reference from the at least one communications console, wherein the identification reference comprises one or more of a verified web service account identifier, letter, number, rights token, e-mail, password, access time, serial number, address, manufacturer identification, checksum, ~~file, circuit,~~ operating system version, browser version, credential, cookie, or key, or ID;

receiving the at least one reference from the at least one communications console; and

writing at least one of the verification token or the reference into the metadata.

2. (Currently amended) The method according to claim 1, wherein the access request being a request from the first user through a data processing device of the plurality of data processing devices; or

wherein the access request being a request from one or more secondary users in network to the first user;

wherein ~~[[said]]~~the secondary users are validated by a membership web service.

3. (Original) The method according to claim 2, wherein the metadata comprises one or more of a software or contents of a web page.

4. (Currently amended) The method according to claim 3, wherein the verification token represents verification from a provider of the token to grant access rights to the first user.

5. (Currently amended) The method according to claim ~~3~~[[4]], wherein the digital content ~~internet-connected data source~~ is shared among one or more users according to a membership status.

6. (Currently amended) The method according to claim 5, wherein the one or more users are a network of recognized human beings using machines or recognized automated computerized mechanisms programmed by human beings, the recognition

of ~~[[said]]~~the one or more users being validated by the membership status of the membership web service.

7. (Currently amended) The method according to claim 6, wherein the digital content internet-connected-data-source access request is from a user using at least one of a computer or a phone hosting an operating system running an application.

8. (Currently amended) The method of claim 7, wherein-said the verification token comprises at least one token selected from the group consisting of a purchase permission, a rental permission, or a membership permission;

wherein-said the at least one of a purchase permission, a rental permission, or a membership permission is represented by one or more of a letter, number, combination of letters and numbers, rights token, successful payment reference, phrase, name, membership credentials, image, logo, tag, service name, authorization, list, interface button, downloadable program, or an instrument of trade.

9. (Currently amended) A system for authorizing ~~monitoring access to digital content-an~~ internet-connected-data-source using a worldwide cloud system infrastructure, the worldwide cloud system infrastructure comprising connected modules in operation as computing and storage, the computing and storage comprising a server, a database, devices and users, wherein the digital content ~~internet-connected-data-source~~ comprises ~~one or more of a machine, video, audio, container, format, document, credit~~



~~card information, personal information, textual information, image, advertisement, logo, tag, message, URL, video game, software, downloadable program, content provider, service provider, or other computer based apparatus in which processed data is facilitated, the data being is at least~~ one of encrypted or not encrypted, the system facilitating access rights between a plurality of data processing devices, the system working as a front-end agent for access rights authentication between the plurality of data processing devices, the system further comprising:

a first receipt module, the first receipt module receiving ~~[[the]]a digital content internet-connected data source~~ access request from at least one communications console of the plurality of data processing devices, the access request being a read or write request of metadata of the ~~digital content internet-connected data source~~, wherein the read or write request of metadata is performed in connection with a combination of a device, the server, the database and the cloud system, the metadata further comprises one or more of a software or contents of a web page, the request comprising a verification token provided by a user corresponding to the ~~digital content internet-connected data source~~, wherein the verification token is one or more of a password, e-mail address, payment system, credit card, authorize ready device, rights token, or one or more redeemable instruments of trade;

an authentication module, the authentication module authenticating the verification token;

a connection module, the connection module establishing a connection with the at least one communications console, wherein the communications console is a combination of a graphic user interface (GUI) and an Application[[s]] Programmable Interface (API) wherein the API is obtained from a verified web service, the web service capable of facilitating a two way data exchange to complete a verification process wherein the data exchange session comprises at least one reference;

a request module, the request module requesting at least one identification reference from the at least one communications console, wherein the identification reference comprises one or more of a verified web service account identifier, letter, number, rights token, e-mail, password, access time, serial number, address, manufacturer identification, checksum, ~~file, circuit,~~ operating system version, browser version, credential, cookie, or key, ~~or~~ ID;

a secondary receipt module, the secondary receipt module receiving the at least one reference from the at least one communications console; and

a branding module, the branding module writing at least one of the verification token or the reference into the metadata.

10. (Currently amended) The system of claim 9, wherein the verification token comprises at least one token selected from the group consisting of a purchase permission, a rental permission, or a membership permission;

wherein the at least one of a purchase permission, a rental permission, or a membership permission is represented by one or more of a tag, letter, number, combination of letters and numbers, rights token, successful payment reference, phrase, name, membership credentials, image, logo, service name, authorization, list, interface button, downloadable program, or an instrument of trade.

11. (Currently amended) ~~An operating system software program for use with at least one data processing device of a plurality of data processing devices, the data processing device hosting at least one operating system software version of a plurality of operating system software versions, the data processing device comprising a non-transitory usable medium storing the operating system software~~ A non-transitory computer medium comprising a program code, the program code being a part of the an operating system software or downloaded in sections from a web server, the operating system software program coupled with a user executing a method for authorizing access to digital content ~~monitoring access to a non-public internet-connected asset using a cloud system, the cloud system comprising internet-connected modules comprising storage and computing, the method facilitating a data exchange session between a combination of the a user in operation of the data processing device and the cloud system, the data exchange session establishing an access permission for the internet-connected asset, wherein the internet-connected asset comprises one or more of a machine, video, audio, container, format, document, credit card information, personal information, textual information, image, advertisement, logo, tag,~~

~~message, URL, video game, software, downloadable program, content provider, service provider, or other computer-based apparatus in which processed data is facilitated, the operating system software program coupled with the user performing wherein the method program code, when executed in a processor for facilitating access rights between a plurality of data processing devices, performs the following steps of:~~

receiving ~~[[the]]~~a digital content ~~internet-connected-asset~~ access request from at least one communications console of the plurality of data processing devices, the access request being a read or write request of metadata of the digital content-~~internet connected-asset~~, wherein the read or write request of metadata is performed in connection with a combination of the operating system software program and the cloud system, the request comprising a verification token provided by the user corresponding to the digital content-~~internet-connected-asset~~, wherein the verification token is one or more of a password, e-mail address, payment system, credit card, authorize ready device, rights token, key, file, or one or more redeemable instruments of trade;

authenticating the verification token;

establishing a connection with the at least one communications console, wherein the communications console is a combination of a graphic user interface (GUI) and an Application[[s]] Programmable Interface (API) wherein the API is obtained from a verified web service, the web service capable of facilitating a two way data exchange to

complete a verification process wherein the data exchange session comprises at least one reference;

requesting at least one identification reference from the at least one communications console, wherein the identification reference is one or more of a verified web service account identifier, letter, number, rights token, e-mail, password, access time, serial number, address, manufacturer identification, checksum, ~~file, circuit,~~ operating system version, browser version, credential, cookie, or key, or ID;

receiving the at least one reference from the at least one communications console; and

writing at least one of the verification token or the reference into the metadata.

12. (Currently amended) The ~~operating system software program~~ non-transitory computer medium according to claim 11, wherein the access request is a request from the user providing a credential to a membership web service through a data processing device of the plurality of data processing devices, the user being a human user establishing a permission to the digital content ~~internet-connected asset~~.

13. (Currently amended) The ~~operating system software program~~ non-transitory computer medium of claim 12, wherein the verification token comprises at least one of a purchase permission, a rental permission, or a membership permission;

wherein the at least one of a purchase permission, a rental permission, or a membership permission is represented by one or more of a tag, letter, number, combination of letters and numbers, successful payment reference, phrase, name, membership credential, image, logo, service name, authorization, list, key, file, interface button, downloadable program, or an instrument of trade.

14. (Currently amended) The ~~operating-system-software-program~~ non-transitory computer medium according to claim 13, wherein the verification token represents verification from a provider that a product was acquired.

15. (Currently amended) The ~~operating-system-software-program~~ non-transitory computer medium according to claim 13, wherein the digital content-internet-connected asset is accessed according to a membership status.

16. (Currently amended) The ~~operating-system-software-program~~ non-transitory computer medium according to claim 15, wherein the membership status is connected to an application programmable interface.

17. (Currently amended) The ~~operating-system-software-program~~ non-transitory computer medium according to claim 15, wherein a remote control operation exist.

18. (Currently amended) The ~~operating system software program~~ non-transitory computer medium according to claim 16, wherein the application programmable interface is connected to a graphic user interface.

19. (Currently amended) The ~~operating system software program~~ non-transitory computer medium according to claim 17, wherein the digital content ~~internet-connected asset~~ is shared with one or more secondary users.

20. (Currently amended) The ~~operating system software program~~ non-transitory computer medium according to claim 19, wherein the digital content ~~internet-connected asset~~ is shared with the secondary user according to a period of time.

21. (Currently amended) A[[n]] computer product comprising a memory, a CPU, a communications console and a non-transitory computer usable medium, the computer usable medium having an operating system stored therein, the computer product further comprising a customization module, the computer product authorizing ~~coupled with a user executing a method for monitoring access to~~ digital content ~~a data source~~, wherein the digital content ~~data source~~ is at least one of an application, a video, or a video game, ~~or a software~~, wherein the ~~data source~~ is one of a local or an internet connected, wherein the digital content ~~data source~~ is at least one of encrypted or not encrypted, the computer product ~~coupled with the user performing~~ configured to perform the method steps of:

receiving ~~[[the]]a digital content-data-source~~ access request from the communications console, the access request being a read or write request of metadata of the ~~digital content-data-source~~, the metadata of the ~~digital content-data-source~~ being one or more of a database or storage in connection to the computer product, the request comprising a verification token corresponding to the ~~digital content-data-source~~, the verification token is handled by ~~[[the]]a~~ user as a redeemable instrument, wherein the verification token comprises at least one of a purchase permission, a rental permission, or a membership permission, wherein the at least one of a purchase permission, a rental permission, or a membership permission being-is represented by one or more of a tag, a letter, a number, a combination of letters and numbers, a successful payment, a rights token, a phrase, a name, a membership credential, an image, a logo, a service name, an authorization, a list, an interface button, a downloadable program, or the redeemable instrument;

authenticating the verification token;

establishing a connection with the communications console, wherein the communications console ~~comprises a data-exchange-session, wherein the data-exchange-session comprises at least one reference~~ is a combination of a graphic user interface (GUI) and an Application[[s]] Programmable Interface (API) wherein the API is obtained from a verified web service, the web service capable of facilitating a two way data exchange to complete a verification process wherein the data exchange session comprises at least one reference;



requesting at least one identification reference from the at least one communications console, wherein the identification reference comprises one or more of a verified web service account identifier, letter, number, rights token, e-mail, password, access time, serial number, address, manufacturer identification, checksum, file, circuit, operating system version, browser version, credential, cookie, or key, or ID;

receiving the at least one reference from the communications console; and

writing at least one of the verification token or the reference into the said metadata.

22. (Currently amended) The computer product according to claim 21, wherein the access request is a request from a first user, the first user is a human user in operation of the computer product and establishes first access to the digital content-data-source; or

wherein the access request is a request from a secondary user, the secondary user is a human user in operation of the computer product and establishes secondary access to the same digital content-data-source as first established for access by the first user.

23. (Original) The computer product according to claim 21, wherein the customization module customizes the tag.

24. (Original) The computer product according to claim 21, wherein the customization module customizes a user access panel.

25. (Currently amended) The computer product according to claim 22, wherein the digital content-a-data-source is monitored for access using a worldwide cloud system infrastructure, the worldwide cloud system infrastructure comprising internet connected modules in operation as computing and storage services in connection to the computer product.

26. (Original) The computer product according to claim 22, wherein the verification token is connected to a royalty scheme.

27. (Original) The computer product according to claim 25, wherein the access is allowed according to a permission facilitated by a web service working as a front-end agent to the worldwide cloud system infrastructure.

28. (Original) The computer product according to claim 25, wherein the computer product is a device of a plurality of devices in a network of the user.

29. (Original) The computer product according to claim 28, wherein the device is a computer or a phone.

30. (Original) The computer product according to claim 29, wherein a remote control operation exist.

## Electronic Patent Application Fee Transmittal

<b>Application Number:</b>	13740086
<b>Filing Date:</b>	11-Jan-2013
<b>Title of Invention:</b>	PERSONALIZED DIGITAL MEDIA ACCESS SYSTEM - PDMAS PART II
<b>First Named Inventor/Applicant Name:</b>	William Grecia
<b>Filer:</b>	William Grecia
<b>Attorney Docket Number:</b>	

Filed as Small Entity

### Utility under 35 USC 111(a) Filing Fees

Description	Fee Code	Quantity	Amount	Sub-Total in USD(\$)
<b>Basic Filing:</b>				
<b>Pages:</b>				
<b>Claims:</b>				
<b>Miscellaneous-Filing:</b>				
<b>Petition:</b>				
<b>Patent-Appeals-and-Interference:</b>				
<b>Post-Allowance-and-Post-Issuance:</b>				
Utility Appl Issue Fee	2501	1	890	890

**Extension-of-Time:**

EWS-003850

Description	Fee Code	Quantity	Amount	Sub-Total in USD(\$)
<b>Miscellaneous:</b>				
<b>Total in USD (\$)</b>				<b>890</b>

## Electronic Acknowledgement Receipt

<b>EFS ID:</b>	15912879
<b>Application Number:</b>	13740086
<b>International Application Number:</b>	
<b>Confirmation Number:</b>	7081
<b>Title of Invention:</b>	PERSONALIZED DIGITAL MEDIA ACCESS SYSTEM - PDMAS PART II
<b>First Named Inventor/Applicant Name:</b>	William Grecia
<b>Customer Number:</b>	70984
<b>Filer:</b>	William Grecia
<b>Filer Authorized By:</b>	
<b>Attorney Docket Number:</b>	
<b>Receipt Date:</b>	31-MAY-2013
<b>Filing Date:</b>	11-JAN-2013
<b>Time Stamp:</b>	00:42:51
<b>Application Type:</b>	Utility under 35 USC 111(a)

### Payment information:

Submitted with Payment	yes
Payment Type	Credit Card
Payment was successfully received in RAM	\$890
RAM confirmation Number	7041
Deposit Account	
Authorized User	

### File Listing:

Document Number	Document Description	File Name	File Size(Bytes)/ Message Digest	Multi Part Zip	Pages (if appl.)
-----------------	----------------------	-----------	-------------------------------------	-------------------	---------------------

1	Issue Fee Payment (PTO-85B)	patentform.pdf	85153	no	2
			68648f66f8ff84cc91c17bbd25c74311a94653ed		
<b>Warnings:</b>					
<b>Information:</b>					
2	Amendment after Notice of Allowance (Rule 312)	PDMASIAA.pdf	216344	no	16
			1a7ce803ac1644073748d814ca351c73185cc7b2		
<b>Warnings:</b>					
<b>Information:</b>					
3	Fee Worksheet (SB06)	fee-info.pdf	30111	no	2
			c4731c46d2af55bb36fbb47acfa64b20a5d7819e		
<b>Warnings:</b>					
<b>Information:</b>					
<b>Total Files Size (in bytes):</b>			331608		

**This Acknowledgement Receipt evidences receipt on the noted date by the USPTO of the indicated documents, characterized by the applicant, and including page counts, where applicable. It serves as evidence of receipt similar to a Post Card, as described in MPEP 503.**

**New Applications Under 35 U.S.C. 111**

**If a new application is being filed and the application includes the necessary components for a filing date (see 37 CFR 1.53(b)-(d) and MPEP 506), a Filing Receipt (37 CFR 1.54) will be issued in due course and the date shown on this Acknowledgement Receipt will establish the filing date of the application.**

**National Stage of an International Application under 35 U.S.C. 371**

**If a timely submission to enter the national stage of an international application is compliant with the conditions of 35 U.S.C. 371 and other applicable requirements a Form PCT/DO/EO/903 indicating acceptance of the application as a national stage submission under 35 U.S.C. 371 will be issued in addition to the Filing Receipt, in due course.**

**New International Application Filed with the USPTO as a Receiving Office**

**If a new international application is being filed and the international application includes the necessary components for an international filing date (see PCT Article 11 and MPEP 1810), a Notification of the International Application Number and of the International Filing Date (Form PCT/RO/105) will be issued in due course, subject to prescriptions concerning national security, and the date shown on this Acknowledgement Receipt will establish the international filing date of the application.**



THE STR3EM TEAM  
2885 SANFORD AVE SW #13208  
GRANDVILLE MI 49418

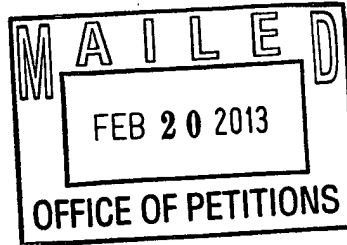

Doc Code: TRACK1.GRANT

<b>Decision Granting Request for Prioritized Examination (Track I or After RCE)</b>	Application No.: 13/740,086
<p>1. THE REQUEST FILED <u>January 11, 2013</u> IS <b>GRANTED</b>.</p> <p>The above-identified application has met the requirements for prioritized examination</p> <p>A. <input checked="" type="checkbox"/> for an original nonprovisional application (Track I).</p> <p>B. <input type="checkbox"/> for an application undergoing continued examination (RCE).</p> <p>2. <b>The above-identified application will undergo prioritized examination.</b> The application will be accorded special status throughout its entire course of prosecution until one of the following occurs:</p> <p>A. filing a <b><u>petition for extension of time</u></b> to extend the time period for filing a reply;</p> <p>B. filing an <b><u>amendment to amend the application to contain more than four independent claims, more than thirty total claims,</u></b> or a multiple dependent claim;</p> <p>C. filing a <b><u>request for continued examination</u></b>;</p> <p>D. filing a notice of appeal;</p> <p>E. filing a request for suspension of action;</p> <p>F. mailing of a notice of allowance;</p> <p>G. mailing of a final Office action;</p> <p>H. completion of examination as defined in 37 CFR 41.102; or</p> <p>I. abandonment of the application.</p>	
<p>Telephone inquiries with regard to this decision should be directed to Irvin Dingle at (571)272-3210, Office of Petitions.</p>	
<p>Irvin Dingle <u>/Irvin Dingle/</u> [Signature]</p>	<p><u>Petitions Examiner</u> (Title)</p>



<b>Doc Code: DIST.E.FILE</b> <b>Document Description: Electronic Terminal Disclaimer - Filed</b>	PTO/SB/25 U.S. Patent and Trademark Office Department of Commerce
---	---

Electronic Petition Request	<b>TERMINAL DISCLAIMER TO OBIATE A PROVISIONAL DOUBLE PATENTING REJECTION OVER A PENDING "REFERENCE" APPLICATION</b>
-----------------------------	--

Application Number	13740086
--------------------	----------

Filing Date	11-Jan-2013
-------------	-------------

First Named Inventor	William Grecia
----------------------	----------------

Attorney Docket Number	
------------------------	--

Title of Invention	PERSONALIZED DIGITAL MEDIA ACCESS SYSTEM - PDMAS PART II
--------------------	--

<input checked="" type="checkbox"/> Filing of terminal disclaimer does not obviate requirement for response under 37 CFR 1.111 to outstanding Office Action  <input checked="" type="checkbox"/> This electronic Terminal Disclaimer is not being used for a Joint Research Agreement.
--

Owner	Percent Interest
William Grecia	100%

The owner(s) of percent interest listed above in the instant application hereby disclaims, except as provided below, the terminal part of the statutory term of any patent granted on the instant application which would extend beyond the expiration date of the full statutory term of any patent granted on pending reference Application Number(s)

13397517 filed on 02/15/2012

as the term of any patent granted on said reference application may be shortened by any terminal disclaimer filed prior to the grant of any patent on the pending reference application. The owner hereby agrees that any patent so granted on the instant application shall be enforceable only for and during such period that it and any patent granted on the reference application are commonly owned. This agreement runs with any patent granted on the instant application and is binding upon the grantee, its successors or assigns.

In making the above disclaimer, the owner does not disclaim the terminal part of any patent granted on the instant application that would extend to the expiration date of the full statutory term of any patent granted on said reference application, "as the term of any patent granted on said reference application may be shortened by any terminal disclaimer filed prior to the grant of any patent on the pending reference application," in the event that any such patent granted on the pending reference application: expires for failure to pay a maintenance fee, is held unenforceable, is found invalid by a court of competent jurisdiction, is statutorily disclaimed in whole or terminally disclaimed under 37 CFR 1.321, has all claims canceled by a reexamination certificate, is reissued, or is in any manner terminated prior to the expiration of its full statutory term as shortened by any terminal disclaimer filed prior to its grant.

<input checked="" type="radio"/> Terminal disclaimer fee under 37 CFR 1.20(d) is included with Electronic Terminal Disclaimer request.
--

I certify, in accordance with 37 CFR 1.4(d)(4), that the terminal disclaimer fee under 37 CFR 1.20(d) required for this terminal disclaimer has already been paid in the above-identified application.

Applicant claims SMALL ENTITY status. See 37 CFR 1.27.

Applicant is no longer claiming SMALL ENTITY status. See 37 CFR 1.27(g)(2).

Applicant(s) status remains as SMALL ENTITY.

Applicant(s) status remains as other than SMALL ENTITY.

I hereby declare that all statements made herein of my own knowledge are true and that all statements made on information and belief are believed to be true; and further that these statements were made with the knowledge that willful false statements and the like so made are punishable by fine or imprisonment, or both, under Section 1001 of Title 18 of the United States Code and that such willful false statements may jeopardize the validity of the application or any patent issued thereon.

THIS PORTION MUST BE COMPLETED BY THE SIGNATORY OR SIGNATORIES

I certify, in accordance with 37 CFR 1.4(d)(4) that I am:

An attorney or agent registered to practice before the Patent and Trademark Office who is of record in this application

Registration Number \_\_\_\_\_

A sole inventor

A joint inventor; I certify that I am authorized to sign this submission on behalf of all of the inventors

A joint inventor; all of whom are signing this request

The assignee of record of the entire interest that has properly made itself of record pursuant to 37 [CFR 3.71](#)

Signature	/william grecia/
Name	William Grecia

\*Statement under 37 CFR 3.73(b) is required if terminal disclaimer is signed by the assignee (owner).  
Form PTO/SB/96 may be used for making this certification. See MPEP § 324.

## Electronic Patent Application Fee Transmittal

<b>Application Number:</b>	13740086
<b>Filing Date:</b>	11-Jan-2013
<b>Title of Invention:</b>	PERSONALIZED DIGITAL MEDIA ACCESS SYSTEM - PDMAS PART II
<b>First Named Inventor/Applicant Name:</b>	William Grecia
<b>Filer:</b>	William Grecia
<b>Attorney Docket Number:</b>	

Filed as Small Entity

### Utility under 35 USC 111(a) Filing Fees

Description	Fee Code	Quantity	Amount	Sub-Total in USD(\$)
<b>Basic Filing:</b>				
Statutory or terminal disclaimer	2814	1	80	80

**Pages:**

**Claims:**

**Miscellaneous-Filing:**

**Petition:**

**Patent-Appeals-and-Interference:**

**Post-Allowance-and-Post-Issuance:**

**Extension-of-Time:**

EWS-003857

Description	Fee Code	Quantity	Amount	Sub-Total in USD(\$)
<b>Miscellaneous:</b>				
<b>Total in USD (\$)</b>				<b>80</b>

Doc Code: DISQ.E.FILE

Document Description: Electronic Terminal Disclaimer – Approved

Application No.: 13740086

Filing Date: 11-Jan-2013

Applicant/Patent under Reexamination: Grecia et al.

Electronic Terminal Disclaimer filed on February 16, 2013

APPROVED

**This patent is subject to a terminal disclaimer**

DISAPPROVED

Approved/Disapproved by: Electronic Terminal Disclaimer automatically approved by EFS-Web

U.S. Patent and Trademark Office

EWS-003859

## Electronic Acknowledgement Receipt

<b>EFS ID:</b>	14978416
<b>Application Number:</b>	13740086
<b>International Application Number:</b>	
<b>Confirmation Number:</b>	7081
<b>Title of Invention:</b>	PERSONALIZED DIGITAL MEDIA ACCESS SYSTEM - PDMAS PART II
<b>First Named Inventor/Applicant Name:</b>	William Grecia
<b>Customer Number:</b>	70984
<b>Filer:</b>	William Grecia
<b>Filer Authorized By:</b>	
<b>Attorney Docket Number:</b>	
<b>Receipt Date:</b>	16-FEB-2013
<b>Filing Date:</b>	11-JAN-2013
<b>Time Stamp:</b>	11:54:25
<b>Application Type:</b>	Utility under 35 USC 111(a)

### Payment information:

Submitted with Payment	yes
Payment Type	Credit Card
Payment was successfully received in RAM	\$80
RAM confirmation Number	7285
Deposit Account	
Authorized User	

### File Listing:

Document Number	Document Description	File Name	File Size(Bytes)/ Message Digest	Multi Part Zip	Pages (if appl.)
-----------------	----------------------	-----------	-------------------------------------	-------------------	---------------------

1	Electronic Terminal Disclaimer-Filed	eTerminal-Disclaimer.pdf	34071	no	2
			fbfb113a2973e347c869089f1db5672f4ca25cc1		
<b>Warnings:</b>					
<b>Information:</b>					
2	Fee Worksheet (SB06)	fee-info.pdf	29683	no	2
			067f38278cf0cd657e3a115812c3123e4798da3f		
<b>Warnings:</b>					
<b>Information:</b>					
<b>Total Files Size (in bytes):</b>			63754		

**This Acknowledgement Receipt evidences receipt on the noted date by the USPTO of the indicated documents, characterized by the applicant, and including page counts, where applicable. It serves as evidence of receipt similar to a Post Card, as described in MPEP 503.**

**New Applications Under 35 U.S.C. 111**

**If a new application is being filed and the application includes the necessary components for a filing date (see 37 CFR 1.53(b)-(d) and MPEP 506), a Filing Receipt (37 CFR 1.54) will be issued in due course and the date shown on this Acknowledgement Receipt will establish the filing date of the application.**

**National Stage of an International Application under 35 U.S.C. 371**

**If a timely submission to enter the national stage of an international application is compliant with the conditions of 35 U.S.C. 371 and other applicable requirements a Form PCT/DO/EO/903 indicating acceptance of the application as a national stage submission under 35 U.S.C. 371 will be issued in addition to the Filing Receipt, in due course.**

**New International Application Filed with the USPTO as a Receiving Office**

**If a new international application is being filed and the international application includes the necessary components for an international filing date (see PCT Article 11 and MPEP 1810), a Notification of the International Application Number and of the International Filing Date (Form PCT/RO/105) will be issued in due course, subject to prescriptions concerning national security, and the date shown on this Acknowledgement Receipt will establish the international filing date of the application.**

IN THE UNITED STATES PATENT AND TRADEMARK OFFICE

In re application of:

William Grecia

Application No.: 13/740,086

Filed: January 11, 2013

For: PERSONALIZED DIGITAL MEDIA

ACCESS SYSTEM – PDMAS PART II

Examiner: N/A

Art Unit: 2431

CNF# 7081

**PRELIMINARY AMENDMENT**

Assistant Commissioner for Patents

P. O. Box 1450

Alexandria VA, 22313-1450

Sir:

This is a corrected preliminary amendment replacement for markup informalities found in the previous replacement preliminary amendment filed on 01/31/2013, in particular in claims #2 and #11 missing the amendment markup of “enabler” to “user”. No new matter has been added to the claims by way of this amendment.

IN THE CLAIMS:

Please replace all of the previously amended submitted versions of claims 1-30 as found in documents submitted on 01/31/2013 and 01/30/2013 with this corrected amended version of claims 1-30 labeled as (Currently amended) and (Original).

Respectfully Submitted:

/william grecia/

William Grecia

Applicant Pro Se



Claims:

1. (Currently amended) A method for monitoring access to an internet connected data source using a cloud system, the cloud system comprising connected modules in operation as one or more of a cloud computing or a cloud storage in connection with devices and users ~~enablers~~, wherein the internet connected data source comprises one or more of a machine, video, audio, container, format, document, credit card information, personal information, textual information, image, advertisement, logo, tag, message, url, video game, software, downloadable program, content provider, service provider, or other computer based apparatus in which processed data is facilitated, the data being one of encrypted or not encrypted, the method facilitating access rights between a plurality of data processing devices, the method comprising:

receiving the internet connected data source access request from at least one communications console of the plurality of data processing devices, the access request being a read or write request of metadata of the internet connected data source, wherein the read or write request of metadata is performed in connection with a combination of at least one device and the cloud system, the request comprising a verification token provided by a first user, corresponding to the internet connected data source, wherein the verification token is one or more of a password, e-mail address, payment system, credit card, authorize ready device, rights token, or one or more redeemable instruments of trade;

authenticating the verification token;

establishing a connection with the at least one communications console, wherein the communications console is a combination of a graphic user interface (GUI) and an Applications Programmable Interface (API);

requesting at least one reference from the at least one communications console, wherein the reference comprises is one or more of a web service account identifier, letter, number, rights token, e-mail, password, access time, serial number, address, manufacturer identification, checksum, file, circuit, operating system version, browser version, credential, cookie, key, or ID;

receiving the at least one reference from the at least one communications console; and

writing at least one of the verification token or the reference into the metadata.

2. (Currently amended) The method according to claim 1, wherein the access request being a request from the first user ~~an excelsior enabler~~ through a data processing device of the plurality of data processing devices; or

wherein the access request being a request from one or more secondary users ~~enablers~~ in network to the first user ~~excelsior enabler~~;

wherein said users ~~enablers~~ are validated by a membership web service.

3. (Original) The method according to claim 2, wherein the metadata comprises one or more of a software or contents of a web page.

4. (Currently amended) The method according to claim 3, wherein the verification token represents verification from a provider of the token to grant access rights to the user ~~enabler~~.

5. (Currently amended) The method according to claim 4, wherein the internet connected data source is shared among one or more users ~~enablers~~ according to a membership status.

6. (Currently amended) The method according to claim 5, wherein the one or more users ~~enablers~~ are a network of recognized human beings using machines or recognized automated computerized mechanisms programmed by human beings, the recognition of said users ~~enablers~~ being validated by the membership status of the membership web service.

7. (Currently amended) The method according to claim 6, wherein the internet connected data source access request is from a user ~~an enabler~~ using a computer or a phone hosting an operating system running an application.

8. (Currently amended) The method of claim 7, wherein said verification token comprises at least one token selected from the group consisting of a purchase permission, a rental permission, or a membership permission;

wherein said permission is represented by one or more of a letter, number, combination of letters and numbers, rights token, successful payment reference, phrase, name, membership credentials, image, logo, tag, service name, authorization, list, interface button, downloadable program, or an instrument of trade.

9. (Currently amended) A system for monitoring access to an internet connected data source using a worldwide cloud system infrastructure, the worldwide cloud system infrastructure comprising connected modules in operation as computing and storage, the computing and storage comprising a server, a database, ~~a device~~ devices and users ~~an enabler~~, wherein the internet connected data source comprises one or more of a

machine, video, audio, container, format, document, credit card information, personal information, textual information, image, advertisement, logo, tag, message, url, video game, software, downloadable program, content provider, service provider, or other computer based apparatus in which processed data is facilitated, the data being one of encrypted or not encrypted, the system facilitating access rights between a plurality of data processing devices, the system working as a front-end agent for access rights authentication between the plurality of data processing devices, ~~said~~ the system further comprising:

a first receipt module, the first receipt module receiving the internet connected data source access request from at least one communications console of the plurality of data processing devices, the access request being a read or write request of metadata of the internet connected data source, wherein the read or write request of metadata is performed in connection with a combination of a device, the server, the database and the cloud system, the metadata further comprises one or more of a software or contents of a web page, the request comprising a verification token provided by a user, corresponding to the internet connected data source, wherein the verification token is one or more of a password, e-mail address, payment system, credit card, authorize ready device, rights token, or one or more redeemable instruments of trade;

an authentication module, the authentication module authenticating the verification token;

a connection module, the connection module establishing a connection with the at least one communications console, wherein the communications console is a

combination of a graphic user interface (GUI) and an Applications Programmable Interface (API);

a request module, the request module requesting at least one reference from the at least one communications console, wherein the reference comprises ~~is~~ one or more of a web service account identifier, letter, number, rights token, e-mail, password, access time, serial number, address, manufacturer identification, checksum, file, circuit, operating system version, browser version, credential, cookie, key, or ID;

a secondary receipt module, the secondary receipt module receiving the at least one reference from the at least one communications console; and

a branding module, the branding module writing at least one of the verification token or the reference into the metadata.

10. (Currently amended) The system of claim 9, wherein the ~~said~~-verification token comprises at least one token selected from the group consisting of a purchase permission, a rental permission, or a membership permission;

Wherein the ~~said~~-permission is represented by one or more of a tag, letter, number, combination of letters and numbers, rights token, successful payment reference, phrase, name, membership credentials, image, logo, service name, authorization, list, interface button, downloadable program, or an instrument of trade.

11. (Currently amended) An operating system software program for use with at least one data processing device of a plurality of data processing devices, the data processing device hosting at least one operating system software version of a plurality of operating system software versions, the data processing device comprising a non-transitory usable medium storing the operating system software comprising a program

code, the program code being a part of the operating system software or downloaded in sections from a web server, the operating system software program coupled with a user ~~an enabler~~ executing a method for monitoring access to a non-public internet connected asset using a cloud system, the cloud system comprising internet connected modules comprising storage and computing, the method facilitating a data exchange session between a combination of the user ~~enabler~~ in operation of the data processing device and the cloud system, the data exchange session establishing an access permission for the internet connected asset, wherein the internet connected asset comprises one or more of a machine, video, audio, container, format, document, credit card information, personal information, textual information, image, advertisement, logo, tag, message, url, video game, software, downloadable program, content provider, service provider, or other computer based apparatus in which processed data is facilitated, the operating system software program coupled with the user ~~enabler~~ performing the method steps of:

receiving the internet connected asset access request from at least one communications console of the plurality of data processing devices, the access request being a read or write request of metadata of the internet connected asset, wherein the read or write request of metadata is performed in connection with a combination of the operating system software program and the cloud system, the request comprising a verification token provided by the user, corresponding to the internet connected asset, wherein the verification token is one or more of a password, e-mail address, payment system, credit card, authorize ready device, rights token, key, file, or one or more redeemable instruments of trade;

authenticating the verification token;

establishing a connection with the at least one communications console, wherein the communications console is a combination of a graphic user interface (GUI) and an Applications Programmable Interface (API);

requesting at least one reference from the at least one communications console, wherein the reference is one or more of a web service account identifier, letter, number, rights token, e-mail, password, access time, serial number, address, manufacturer identification, checksum, file, circuit, operating system version, browser version, credential, cookie, key, or ID;

receiving the at least one reference from the at least one communications console; and

writing at least one of the verification token or the reference into the metadata.

12. (Currently amended) The operating system software program according to claim 11, wherein the access request is a request from the user enabler—providing a credential to a membership web service through a data processing device of the plurality of data processing devices, the user enabler—being a human user establishing a permission to the internet connected asset.

13. (Currently amended) The operating system software program of claim 12, wherein the verification token comprises at least one of a purchase permission, a rental permission, or a membership permission;

Wherein the said—permission is represented by one or more of a tag, letter, number, combination of letters and numbers, successful payment reference, phrase, name, membership credential, image, logo, service name, authorization, list, key, file, interface button, downloadable program, or an instrument of trade.

14. (Original) The operating system software program according to claim 13, wherein the verification token represents verification from a provider that a product was acquired.
15. (Original) The operating system software program according to claim 13, wherein the internet connected asset is accessed according to a membership status.
16. (Original) The operating system software program according to claim 15, wherein the membership status is connected to an application programmable interface.
17. (Original) The operating system software program according to claim 15, wherein a remote control operation exist.
18. (Original) The operating system software program according to claim 16, wherein the application programmable interface is connected to a graphic user interface.
19. (Original) The operating system software program according to claim 17, wherein the internet connected asset is shared with one or more secondary users.
20. (Original) The operating system software program according to claim 19, wherein the internet connected asset is shared with the secondary user according to a period of time.
21. (Currently amended) A computer product comprising a memory, a CPU, a communications console and a non-transitory computer usable medium, the computer usable medium having an operating system stored therein, the computer product further comprising a customization module, the computer product coupled with a user ~~an enabler~~ executing a method for monitoring access to a data source, wherein the data source is one of an application, a video, a video game, or a software, wherein the data source ~~is being~~ is one of a local or an internet connected, wherein the data source is one



of encrypted or not encrypted, the computer product coupled with the user ~~said enabler~~ performing the method steps of:

receiving the data source access request from the communications console, the access request being a read or write request of metadata of the data source, the metadata of the data source being one or more of a database or storage in connection to the computer product, the request comprising a verification token corresponding to the data source, the verification token is handled by the user ~~enabler~~ as a redeemable instrument, wherein the verification token comprises at least one of a purchase permission, a rental permission, or a membership permission, the permission being represented by one or more of a tag, a letter, a number, a combination of letters and numbers, a successful payment, a rights token, a phrase, a name, a membership credential, an image, a logo, a service name, an authorization, a list, an interface button, a downloadable program, or the redeemable instrument;

authenticating the verification token;

establishing a connection with the communications console, wherein the communications console comprises a data exchange session, wherein the data exchange session comprises at least one reference;

requesting the at least one reference from the communications console, wherein the reference is one or more of a web service account identifier, letter, number, rights token, e-mail, password, access time, serial number, address, manufacturer identification, checksum, file, circuit, operating system version, browser version, credential, cookie, key, or ID;

receiving the at least one reference from the communications console; and

writing at least one of the verification token or the reference into the said metadata.

22. (Currently amended) The computer product according to claim 21, wherein the access request is a request from a first user ~~an excelsior enabler~~, the first user ~~excelsior enabler~~ is a human user in operation of the computer product and establishes first access to the data source; or

wherein the access request is a request from a secondary user ~~enabler~~, the secondary user ~~enabler~~ is a human user in operation of the computer product and establishes secondary access to the same data source as first established for access by the first user ~~excelsior enabler~~.

23. (Original) The computer product according to claim 21, wherein the customization module customizes the tag.

24. (Original) The computer product according to claim 21, wherein the customization module customizes a user access panel.

25. (Currently amended) The computer product according to claim 22, wherein a data source is monitored for access using a worldwide cloud system infrastructure, the worldwide cloud system infrastructure comprising internet connected modules in operation as computing and storage services in connection to the computer product.

26. (Original) The computer product according to claim 22, wherein the verification token is connected to a royalty scheme.

27. (Currently amended) The computer product according to claim 25, wherein the access is allowed according to a permission facilitated by a web service ~~connected~~ working as a front-end agent to the worldwide cloud system infrastructure.

28. (Currently amended) The computer product according to claim 25, wherein the computer product is a device of a plurality of devices in a network of the user-enabler.

29. (Original) The computer product according to claim 28, wherein the device is a computer or a phone.

30. (Original) The computer product according to claim 29, wherein a remote control operation exist.

## Electronic Acknowledgement Receipt

<b>EFS ID:</b>	14978466
<b>Application Number:</b>	13740086
<b>International Application Number:</b>	
<b>Confirmation Number:</b>	7081
<b>Title of Invention:</b>	PERSONALIZED DIGITAL MEDIA ACCESS SYSTEM - PDMAS PART II
<b>First Named Inventor/Applicant Name:</b>	William Grecia
<b>Customer Number:</b>	70984
<b>Filer:</b>	William Grecia
<b>Filer Authorized By:</b>	
<b>Attorney Docket Number:</b>	
<b>Receipt Date:</b>	16-FEB-2013
<b>Filing Date:</b>	11-JAN-2013
<b>Time Stamp:</b>	13:36:26
<b>Application Type:</b>	Utility under 35 USC 111(a)

### Payment information:

Submitted with Payment	no
------------------------	----

### File Listing:

Document Number	Document Description	File Name	File Size(Bytes)/ Message Digest	Multi Part /.zip	Pages (if appl.)
1	Preliminary Amendment	PDMASII-claim-CORRECTEDo2.pdf	51013 <small>5b55c7136cf9885506cf27fe4d282c3f4a036283</small>	no	12

### Warnings:

### Information:

EWS-003874

**This Acknowledgement Receipt evidences receipt on the noted date by the USPTO of the indicated documents, characterized by the applicant, and including page counts, where applicable. It serves as evidence of receipt similar to a Post Card, as described in MPEP 503.**

**New Applications Under 35 U.S.C. 111**

**If a new application is being filed and the application includes the necessary components for a filing date (see 37 CFR 1.53(b)-(d) and MPEP 506), a Filing Receipt (37 CFR 1.54) will be issued in due course and the date shown on this Acknowledgement Receipt will establish the filing date of the application.**

**National Stage of an International Application under 35 U.S.C. 371**

**If a timely submission to enter the national stage of an international application is compliant with the conditions of 35 U.S.C. 371 and other applicable requirements a Form PCT/DO/EO/903 indicating acceptance of the application as a national stage submission under 35 U.S.C. 371 will be issued in addition to the Filing Receipt, in due course.**

**New International Application Filed with the USPTO as a Receiving Office**

**If a new international application is being filed and the international application includes the necessary components for an international filing date (see PCT Article 11 and MPEP 1810), a Notification of the International Application Number and of the International Filing Date (Form PCT/RO/105) will be issued in due course, subject to prescriptions concerning national security, and the date shown on this Acknowledgement Receipt will establish the international filing date of the application.**

Under the Paperwork Reduction Act of 1995, no persons are required to respond to a collection of information unless it displays a valid OMB control number.

<b>PATENT APPLICATION FEE DETERMINATION RECORD</b> Substitute for Form PTO-875	Application or Docket Number <b>13/740,086</b>	Filing Date <b>01/11/2013</b>	<input type="checkbox"/> To be Mailed
---	---	----------------------------------	---------------------------------------

ENTITY:  LARGE  SMALL  MICRO

**APPLICATION AS FILED – PART I**

FOR	NUMBER FILED	NUMBER EXTRA	RATE (\$)	FEE (\$)
<input type="checkbox"/> BASIC FEE (37 CFR 1.16(a), (b), or (c))	N/A	N/A	N/A	
<input type="checkbox"/> SEARCH FEE (37 CFR 1.16(k), (l), or (m))	N/A	N/A	N/A	
<input type="checkbox"/> EXAMINATION FEE (37 CFR 1.16(o), (p), or (q))	N/A	N/A	N/A	
TOTAL CLAIMS (37 CFR 1.16(i))	minus 20 =	*	X \$ =	
INDEPENDENT CLAIMS (37 CFR 1.16(h))	minus 3 =	*	X \$ =	
<input type="checkbox"/> APPLICATION SIZE FEE (37 CFR 1.16(s))	If the specification and drawings exceed 100 sheets of paper, the application size fee due is \$310 (\$155 for small entity) for each additional 50 sheets or fraction thereof. See 35 U.S.C. 41(a)(1)(G) and 37 CFR 1.16(s).			
<input type="checkbox"/> MULTIPLE DEPENDENT CLAIM PRESENT (37 CFR 1.16(j))				
* If the difference in column 1 is less than zero, enter "0" in column 2.			TOTAL	

**APPLICATION AS AMENDED – PART II**

	(Column 1)	(Column 2)	(Column 3)	PRESENT EXTRA	RATE (\$)	ADDITIONAL FEE (\$)
<b>AMENDMENT</b>	<b>02/16/2013</b>	CLAIMS REMAINING AFTER AMENDMENT	HIGHEST NUMBER PREVIOUSLY PAID FOR			
	Total (37 CFR 1.16(i))	* 30	Minus	** 30	= 0	X \$31 = 0
	Independent (37 CFR 1.16(h))	* 4	Minus	***4	= 0	X \$125 = 0
	<input type="checkbox"/> Application Size Fee (37 CFR 1.16(s))					
<input type="checkbox"/> FIRST PRESENTATION OF MULTIPLE DEPENDENT CLAIM (37 CFR 1.16(j))						
					TOTAL ADD'L FEE	<b>0</b>

	(Column 1)	(Column 2)	(Column 3)	PRESENT EXTRA	RATE (\$)	ADDITIONAL FEE (\$)
<b>AMENDMENT</b>		CLAIMS REMAINING AFTER AMENDMENT	HIGHEST NUMBER PREVIOUSLY PAID FOR			
	Total (37 CFR 1.16(i))	*	Minus	**	=	X \$ =
	Independent (37 CFR 1.16(h))	*	Minus	***	=	X \$ =
	<input type="checkbox"/> Application Size Fee (37 CFR 1.16(s))					
<input type="checkbox"/> FIRST PRESENTATION OF MULTIPLE DEPENDENT CLAIM (37 CFR 1.16(j))						
					TOTAL ADD'L FEE	

\* If the entry in column 1 is less than the entry in column 2, write "0" in column 3.  
 \*\* If the "Highest Number Previously Paid For" IN THIS SPACE is less than 20, enter "20".  
 \*\*\* If the "Highest Number Previously Paid For" IN THIS SPACE is less than 3, enter "3".  
 The "Highest Number Previously Paid For" (Total or Independent) is the highest number found in the appropriate box in column 1.

LIE  
/MINNIE JACKSON/

This collection of information is required by 37 CFR 1.16. The information is required to obtain or retain a benefit by the public which is to file (and by the USPTO to process) an application. Confidentiality is governed by 35 U.S.C. 122 and 37 CFR 1.14. This collection is estimated to take 12 minutes to complete, including gathering, preparing, and submitting the completed application form to the USPTO. Time will vary depending upon the individual case. Any comments on the amount of time you require to complete this form and/or suggestions for reducing this burden, should be sent to the Chief Information Officer, U.S. Patent and Trademark Office, U.S. Department of Commerce, P.O. Box 1450, Alexandria, VA 22313-1450. DO NOT SEND FEES OR COMPLETED FORMS TO THIS ADDRESS. **SEND TO: Commissioner for Patents, P.O. Box 1450, Alexandria, VA 22313-1450.**

If you need assistance in completing the form, call 1-800-PTO-9199 and select option 2.



UNITED STATES PATENT AND TRADEMARK OFFICE

UNITED STATES DEPARTMENT OF COMMERCE
United States Patent and Trademark Office
Address: COMMISSIONER FOR PATENTS
P.O. Box 1450
Alexandria, Virginia 22313-1450
www.uspto.gov

Table with 6 columns: APPLICATION NUMBER, FILING or 371(c) DATE, GRP ART UNIT, FIL FEE REC'D, ATTY. DOCKET NO, TOT CLAIMS, IND CLAIMS. Row 1: 13/740,086, 01/11/2013, 2431, 1268, , 30, 4

CONFIRMATION NO. 7081

FILING RECEIPT



70984
The STR3EM Team
2885 Sanford Ave SW #13208
Grandville, MI 49418

Date Mailed: 02/12/2013

Receipt is acknowledged of this non-provisional patent application. The application will be taken up for examination in due course. Applicant will be notified as to the results of the examination. Any correspondence concerning the application must include the following identification information: the U.S. APPLICATION NUMBER, FILING DATE, NAME OF APPLICANT, and TITLE OF INVENTION. Fees transmitted by check or draft are subject to collection. Please verify the accuracy of the data presented on this receipt. If an error is noted on this Filing Receipt, please submit a written request for a Filing Receipt Correction. Please provide a copy of this Filing Receipt with the changes noted thereon. If you received a "Notice to File Missing Parts" for this application, please submit any corrections to this Filing Receipt with your reply to the Notice. When the USPTO processes the reply to the Notice, the USPTO will generate another Filing Receipt incorporating the requested corrections

Inventor(s) William Grecia, Brooklyn, NY;

Applicant(s) William Grecia, Brooklyn, NY;

Power of Attorney: None

Domestic Applications for which benefit is claimed - None.

A proper domestic benefit claim must be provided in an Application Data Sheet in order to constitute a claim for domestic benefit. See 37 CFR 1.76 and 1.78.

Foreign Applications for which priority is claimed (You may be eligible to benefit from the Patent Prosecution Highway program at the USPTO. Please see http://www.uspto.gov for more information.) - None.

Foreign application information must be provided in an Application Data Sheet in order to constitute a claim to foreign priority. See 37 CFR 1.55 and 1.76.

If Required, Foreign Filing License Granted: 02/05/2013

The country code and number of your priority application, to be used for filing abroad under the Paris Convention, is US 13/740,086

Projected Publication Date: 07/17/2014

Non-Publication Request: No

Early Publication Request: No

\*\* SMALL ENTITY \*\*

**Title**

PERSONALIZED DIGITAL MEDIA ACCESS SYSTEM - PDMAS PART II

**Preliminary Class**

713

**PROTECTING YOUR INVENTION OUTSIDE THE UNITED STATES**

Since the rights granted by a U.S. patent extend only throughout the territory of the United States and have no effect in a foreign country, an inventor who wishes patent protection in another country must apply for a patent in a specific country or in regional patent offices. Applicants may wish to consider the filing of an international application under the Patent Cooperation Treaty (PCT). An international (PCT) application generally has the same effect as a regular national patent application in each PCT-member country. The PCT process **simplifies** the filing of patent applications on the same invention in member countries, but **does not result** in a grant of "an international patent" and does not eliminate the need of applicants to file additional documents and fees in countries where patent protection is desired.

Almost every country has its own patent law, and a person desiring a patent in a particular country must make an application for patent in that country in accordance with its particular laws. Since the laws of many countries differ in various respects from the patent law of the United States, applicants are advised to seek guidance from specific foreign countries to ensure that patent rights are not lost prematurely.

Applicants also are advised that in the case of inventions made in the United States, the Director of the USPTO must issue a license before applicants can apply for a patent in a foreign country. The filing of a U.S. patent application serves as a request for a foreign filing license. The application's filing receipt contains further information and guidance as to the status of applicant's license for foreign filing.

Applicants may wish to consult the USPTO booklet, "General Information Concerning Patents" (specifically, the section entitled "Treaties and Foreign Patents") for more information on timeframes and deadlines for filing foreign patent applications. The guide is available either by contacting the USPTO Contact Center at 800-786-9199, or it can be viewed on the USPTO website at <http://www.uspto.gov/web/offices/pac/doc/general/index.html>.

For information on preventing theft of your intellectual property (patents, trademarks and copyrights), you may wish to consult the U.S. Government website, <http://www.stopfakes.gov>. Part of a Department of Commerce initiative, this website includes self-help "toolkits" giving innovators guidance on how to protect intellectual property in specific countries such as China, Korea and Mexico. For questions regarding patent enforcement issues, applicants may call the U.S. Government hotline at 1-866-999-HALT (1-866-999-4158).

**LICENSE FOR FOREIGN FILING UNDER**

**Title 35, United States Code, Section 184**

**Title 37, Code of Federal Regulations, 5.11 & 5.15**

**GRANTED**

The applicant has been granted a license under 35 U.S.C. 184, if the phrase "IF REQUIRED, FOREIGN FILING LICENSE GRANTED" followed by a date appears on this form. Such licenses are issued in all applications where the conditions for issuance of a license have been met, regardless of whether or not a license may be required as



set forth in 37 CFR 5.15. The scope and limitations of this license are set forth in 37 CFR 5.15(a) unless an earlier license has been issued under 37 CFR 5.15(b). The license is subject to revocation upon written notification. The date indicated is the effective date of the license, unless an earlier license of similar scope has been granted under 37 CFR 5.13 or 5.14.

This license is to be retained by the licensee and may be used at any time on or after the effective date thereof unless it is revoked. This license is automatically transferred to any related applications(s) filed under 37 CFR 1.53(d). This license is not retroactive.

The grant of a license does not in any way lessen the responsibility of a licensee for the security of the subject matter as imposed by any Government contract or the provisions of existing laws relating to espionage and the national security or the export of technical data. Licensees should apprise themselves of current regulations especially with respect to certain countries, of other agencies, particularly the Office of Defense Trade Controls, Department of State (with respect to Arms, Munitions and Implements of War (22 CFR 121-128)); the Bureau of Industry and Security, Department of Commerce (15 CFR parts 730-774); the Office of Foreign Assets Control, Department of Treasury (31 CFR Parts 500+) and the Department of Energy.

#### **NOT GRANTED**

No license under 35 U.S.C. 184 has been granted at this time, if the phrase "IF REQUIRED, FOREIGN FILING LICENSE GRANTED" DOES NOT appear on this form. Applicant may still petition for a license under 37 CFR 5.12, if a license is desired before the expiration of 6 months from the filing date of the application. If 6 months has lapsed from the filing date of this application and the licensee has not received any indication of a secrecy order under 35 U.S.C. 181, the licensee may foreign file the application pursuant to 37 CFR 5.15(b).

---

### ***SelectUSA***

The United States represents the largest, most dynamic marketplace in the world and is an unparalleled location for business investment, innovation, and commercialization of new technologies. The U.S. offers tremendous resources and advantages for those who invest and manufacture goods here. Through SelectUSA, our nation works to promote and facilitate business investment. SelectUSA provides information assistance to the international investor community; serves as an ombudsman for existing and potential investors; advocates on behalf of U.S. cities, states, and regions competing for global investment; and counsels U.S. economic development organizations on investment attraction best practices. To learn more about why the United States is the best country in the world to develop technology, manufacture products, deliver services, and grow your business, visit <http://www.SelectUSA.gov> or call +1-202-482-6800.

**PATENT APPLICATION FEE DETERMINATION RECORD**

Substitute for Form PTO-875

Application or Docket Number  
13/740,086

**APPLICATION AS FILED - PART I**

(Column 1) (Column 2)

FOR	NUMBER FILED	NUMBER EXTRA
BASIC FEE (37 CFR 1.16(a), (b), or (c))	N/A	N/A
SEARCH FEE (37 CFR 1.16(k), (l), or (m))	N/A	N/A
EXAMINATION FEE (37 CFR 1.16(o), (p), or (q))	N/A	N/A
TOTAL CLAIMS (37 CFR 1.16(j))	30 minus 20 = *	10
INDEPENDENT CLAIMS (37 CFR 1.16(h))	4 minus 3 = *	1
APPLICATION SIZE FEE (37 CFR 1.16(s))	If the specification and drawings exceed 100 sheets of paper, the application size fee due is \$310 (\$155 for small entity) for each additional 50 sheets or fraction thereof. See 35 U.S.C. 41(a)(1)(G) and 37 CFR 1.16(s).	
MULTIPLE DEPENDENT CLAIM PRESENT (37 CFR 1.16(j))		

\* If the difference in column 1 is less than zero, enter "0" in column 2.

**SMALL ENTITY**

RATE(\$)	FEE(\$)
N/A	98
N/A	310
N/A	125
x 31 =	310
x 125 =	125
	0.00
	0.00
<b>TOTAL</b>	<b>968</b>

**OR OTHER THAN SMALL ENTITY**

RATE(\$)	FEE(\$)
N/A	
N/A	
N/A	
<b>TOTAL</b>	

**APPLICATION AS AMENDED - PART II**

(Column 1) (Column 2) (Column 3)

AMENDMENT A	CLAIMS REMAINING AFTER AMENDMENT	HIGHEST NUMBER PREVIOUSLY PAID FOR	PRESENT EXTRA
	Total (37 CFR 1.16(i))	Minus **	=
	Independent (37 CFR 1.16(h))	Minus ***	=
	Application Size Fee (37 CFR 1.16(s))		
FIRST PRESENTATION OF MULTIPLE DEPENDENT CLAIM (37 CFR 1.16(j))			

**SMALL ENTITY**

RATE(\$)	ADDITIONAL FEE(\$)
x =	
x =	
<b>TOTAL ADD'L FEE</b>	

**OR OTHER THAN SMALL ENTITY**

RATE(\$)	ADDITIONAL FEE(\$)
x =	
x =	
<b>TOTAL ADD'L FEE</b>	

(Column 1) (Column 2) (Column 3)

AMENDMENT B	CLAIMS REMAINING AFTER AMENDMENT	HIGHEST NUMBER PREVIOUSLY PAID FOR	PRESENT EXTRA
	Total (37 CFR 1.16(i))	Minus **	=
	Independent (37 CFR 1.16(h))	Minus ***	=
	Application Size Fee (37 CFR 1.16(s))		
FIRST PRESENTATION OF MULTIPLE DEPENDENT CLAIM (37 CFR 1.16(j))			

RATE(\$)	ADDITIONAL FEE(\$)
x =	
x =	
<b>TOTAL ADD'L FEE</b>	

**OR OTHER THAN SMALL ENTITY**

RATE(\$)	ADDITIONAL FEE(\$)
x =	
x =	
<b>TOTAL ADD'L FEE</b>	

\* If the entry in column 1 is less than the entry in column 2, write "0" in column 3.

\*\* If the "Highest Number Previously Paid For" IN THIS SPACE is less than 20, enter "20".

\*\*\* If the "Highest Number Previously Paid For" IN THIS SPACE is less than 3, enter "3".

The "Highest Number Previously Paid For" (Total or Independent) is the highest found in the appropriate box in column 1.

<b>INFORMATION DISCLOSURE STATEMENT BY APPLICANT</b> ( Not for submission under 37 CFR 1.99)	Application Number		13740086	
	Filing Date		2013-01-11	
	First Named Inventor	William Grecia		
	Art Unit		2431	
	Examiner Name	Not Applicable		
	Attorney Docket Number			

U.S.PATENTS						Remove
Examiner Initial*	Cite No	Patent Number	Kind Code <sup>1</sup>	Issue Date	Name of Patentee or Applicant of cited Document	Pages,Columns,Lines where Relevant Passages or Relevant Figures Appear
	1					

If you wish to add additional U.S. Patent citation information please click the Add button. Add

U.S.PATENT APPLICATION PUBLICATIONS						Remove
Examiner Initial*	Cite No	Publication Number	Kind Code <sup>1</sup>	Publication Date	Name of Patentee or Applicant of cited Document	Pages,Columns,Lines where Relevant Passages or Relevant Figures Appear
	1					

If you wish to add additional U.S. Published Application citation information please click the Add button. Add

FOREIGN PATENT DOCUMENTS								Remove
Examiner Initial*	Cite No	Foreign Document Number <sup>3</sup>	Country Code <sup>2</sup> j	Kind Code <sup>4</sup>	Publication Date	Name of Patentee or Applicant of cited Document	Pages,Columns,Lines where Relevant Passages or Relevant Figures Appear	T <sup>5</sup>
	1							<input type="checkbox"/>

If you wish to add additional Foreign Patent Document citation information please click the Add button Add

NON-PATENT LITERATURE DOCUMENTS				Remove
Examiner Initials*	Cite No	Include name of the author (in CAPITAL LETTERS), title of the article (when appropriate), title of the item (book, magazine, journal, serial, symposium, catalog, etc), date, pages(s), volume-issue number(s), publisher, city and/or country where published.		T <sup>5</sup>

<b>INFORMATION DISCLOSURE STATEMENT BY APPLICANT</b> ( Not for submission under 37 CFR 1.99)	Application Number		13740086
	Filing Date		2013-01-11
	First Named Inventor	William Grecia	
	Art Unit		2431
	Examiner Name	Not Applicable	
	Attorney Docket Number		

1	Copy of co-pending U.S. patent application #13/397,517 document reference: 2013-02-04 Notice of Allowance and Fees Due (PTOL-85)	<input type="checkbox"/>
2	Copy of co-pending U.S. patent application #13/397,517 document reference: 2013-02-04 Examiner initiated interview summary (PTOL-413B)	<input type="checkbox"/>
3	Copy of co-pending U.S. patent application #13/397,517 document reference: 2013-02-04 Examiner's Amendment and Detailed Action	<input type="checkbox"/>
4	Copy of co-pending U.S. patent application #13/397,517 document reference: 2013-02-04 Issue Information including classification, examiner, name, claim, renumbering, etc.	<input type="checkbox"/>
5	Copy of co-pending U.S. patent application #13/397,517 document reference: 2013-02-04 List of References cited by applicant and considered by examiner	<input type="checkbox"/>
6	Copy of co-pending U.S. patent application #13/397,517 document reference: 2013-02-04 Index of Claims	<input type="checkbox"/>
7	Copy of co-pending U.S. patent application #13/397,517 document reference: 2013-02-04 Search information including classification, databases and other search related notes	<input type="checkbox"/>
8	Copy of co-pending U.S. patent application #13/397,517 document reference: 2013-02-04 Examiner's search strategy and results	<input type="checkbox"/>

If you wish to add additional non-patent literature document citation information please click the Add button **Add**

**EXAMINER SIGNATURE**

Examiner Signature		Date Considered	
--------------------	--	-----------------	--

\*EXAMINER: Initial if reference considered, whether or not citation is in conformance with MPEP 609. Draw line through a citation if not in conformance and not considered. Include copy of this form with next communication to applicant.

<sup>1</sup> See Kind Codes of USPTO Patent Documents at [www.USPTO.GOV](http://www.USPTO.GOV) or MPEP 901.04. <sup>2</sup> Enter office that issued the document, by the two-letter code (WIPO Standard ST.3). <sup>3</sup> For Japanese patent documents, the indication of the year of the reign of the Emperor must precede the serial number of the patent document. <sup>4</sup> Kind of document by the appropriate symbols as indicated on the document under WIPO Standard ST.16 if possible. <sup>5</sup> Applicant is to place a check mark here if English language translation is attached.

**INFORMATION DISCLOSURE  
STATEMENT BY APPLICANT**  
( Not for submission under 37 CFR 1.99)

Application Number	13740086
Filing Date	2013-01-11
First Named Inventor	William Grecia
Art Unit	2431
Examiner Name	Not Applicable
Attorney Docket Number	

**CERTIFICATION STATEMENT**

Please see 37 CFR 1.97 and 1.98 to make the appropriate selection(s):

That each item of information contained in the information disclosure statement was first cited in any communication from a foreign patent office in a counterpart foreign application not more than three months prior to the filing of the information disclosure statement. See 37 CFR 1.97(e)(1).

**OR**

That no item of information contained in the information disclosure statement was cited in a communication from a foreign patent office in a counterpart foreign application, and, to the knowledge of the person signing the certification after making reasonable inquiry, no item of information contained in the information disclosure statement was known to any individual designated in 37 CFR 1.56(c) more than three months prior to the filing of the information disclosure statement. See 37 CFR 1.97(e)(2).

See attached certification statement.

The fee set forth in 37 CFR 1.17 (p) has been submitted herewith.

A certification statement is not submitted herewith.

**SIGNATURE**

A signature of the applicant or representative is required in accordance with CFR 1.33, 10.18. Please see CFR 1.4(d) for the form of the signature.

Signature	/william grecia/	Date (YYYY-MM-DD)	2013-02-04
Name/Print	William Grecia	Registration Number	70984

This collection of information is required by 37 CFR 1.97 and 1.98. The information is required to obtain or retain a benefit by the public which is to file (and by the USPTO to process) an application. Confidentiality is governed by 35 U.S.C. 122 and 37 CFR 1.14. This collection is estimated to take 1 hour to complete, including gathering, preparing and submitting the completed application form to the USPTO. Time will vary depending upon the individual case. Any comments on the amount of time you require to complete this form and/or suggestions for reducing this burden, should be sent to the Chief Information Officer, U.S. Patent and Trademark Office, U.S. Department of Commerce, P.O. Box 1450, Alexandria, VA 22313-1450. **DO NOT SEND FEES OR COMPLETED FORMS TO THIS ADDRESS. SEND TO: Commissioner for Patents, P.O. Box 1450, Alexandria, VA 22313-1450.**

## Privacy Act Statement

The Privacy Act of 1974 (P.L. 93-579) requires that you be given certain information in connection with your submission of the attached form related to a patent application or patent. Accordingly, pursuant to the requirements of the Act, please be advised that: (1) the general authority for the collection of this information is 35 U.S.C. 2(b)(2); (2) furnishing of the information solicited is voluntary; and (3) the principal purpose for which the information is used by the U.S. Patent and Trademark Office is to process and/or examine your submission related to a patent application or patent. If you do not furnish the requested information, the U.S. Patent and Trademark Office may not be able to process and/or examine your submission, which may result in termination of proceedings or abandonment of the application or expiration of the patent.

The information provided by you in this form will be subject to the following routine uses:

1. The information on this form will be treated confidentially to the extent allowed under the Freedom of Information Act (5 U.S.C. 552) and the Privacy Act (5 U.S.C. 552a). Records from this system of records may be disclosed to the Department of Justice to determine whether the Freedom of Information Act requires disclosure of these records.
2. A record from this system of records may be disclosed, as a routine use, in the course of presenting evidence to a court, magistrate, or administrative tribunal, including disclosures to opposing counsel in the course of settlement negotiations.
3. A record in this system of records may be disclosed, as a routine use, to a Member of Congress submitting a request involving an individual, to whom the record pertains, when the individual has requested assistance from the Member with respect to the subject matter of the record.
4. A record in this system of records may be disclosed, as a routine use, to a contractor of the Agency having need for the information in order to perform a contract. Recipients of information shall be required to comply with the requirements of the Privacy Act of 1974, as amended, pursuant to 5 U.S.C. 552a(m).
5. A record related to an International Application filed under the Patent Cooperation Treaty in this system of records may be disclosed, as a routine use, to the International Bureau of the World Intellectual Property Organization, pursuant to the Patent Cooperation Treaty.
6. A record in this system of records may be disclosed, as a routine use, to another federal agency for purposes of National Security review (35 U.S.C. 181) and for review pursuant to the Atomic Energy Act (42 U.S.C. 218(c)).
7. A record from this system of records may be disclosed, as a routine use, to the Administrator, General Services, or his/her designee, during an inspection of records conducted by GSA as part of that agency's responsibility to recommend improvements in records management practices and programs, under authority of 44 U.S.C. 2904 and 2906. Such disclosure shall be made in accordance with the GSA regulations governing inspection of records for this purpose, and any other relevant (i.e., GSA or Commerce) directive. Such disclosure shall not be used to make determinations about individuals.
8. A record from this system of records may be disclosed, as a routine use, to the public after either publication of the application pursuant to 35 U.S.C. 122(b) or issuance of a patent pursuant to 35 U.S.C. 151. Further, a record may be disclosed, subject to the limitations of 37 CFR 1.14, as a routine use, to the public if the record was filed in an application which became abandoned or in which the proceedings were terminated and which application is referenced by either a published application, an application open to public inspections or an issued patent.
9. A record from this system of records may be disclosed, as a routine use, to a Federal, State, or local law enforcement agency, if the USPTO becomes aware of a violation or potential violation of law or regulation.

## Electronic Acknowledgement Receipt

<b>EFS ID:</b>	14861175
<b>Application Number:</b>	13740086
<b>International Application Number:</b>	
<b>Confirmation Number:</b>	7081
<b>Title of Invention:</b>	PERSONALIZED DIGITAL MEDIA ACCESS SYSTEM - PDMA5 PART II
<b>First Named Inventor/Applicant Name:</b>	William Grecia
<b>Customer Number:</b>	70984
<b>Filer:</b>	William Grecia
<b>Filer Authorized By:</b>	
<b>Attorney Docket Number:</b>	
<b>Receipt Date:</b>	04-FEB-2013
<b>Filing Date:</b>	
<b>Time Stamp:</b>	01:09:09
<b>Application Type:</b>	Utility under 35 USC 111(a)

### Payment information:

Submitted with Payment	no
------------------------	----

### File Listing:

Document Number	Document Description	File Name	File Size(Bytes)/ Message Digest	Multi Part /.zip	Pages (if appl.)
1	Information Disclosure Statement (IDS) Form (SB08)	IDS-noa.pdf	612688 <small>7c3c33414debd96e9a31b8ea652ab1b20e85d7d3</small>	no	4

### Warnings:

### Information:

EWS-003885

A U.S. Patent Number Citation or a U.S. Publication Number Citation is required in the Information Disclosure Statement (IDS) form for autoloading of data into USPTO systems. You may remove the form to add the required data in order to correct the Informational Message if you are citing U.S. References. If you chose not to include U.S. References, the image of the form will be processed and be made available within the Image File Wrapper (IFW) system. However, no data will be extracted from this form. Any additional data such as Foreign Patent Documents or Non Patent Literature will be manually reviewed and keyed into USPTO systems.

2	Other Reference-Patent or Application Document	copy-noa.pdf	5914683 <small>36c1518cfc4a6427f303624279d85d29b010c08</small>	no	89
---	--	--------------	---	----	----

**Warnings:**

**Information:**

<b>Total Files Size (in bytes):</b>	6527371
-------------------------------------	---------

**This Acknowledgement Receipt evidences receipt on the noted date by the USPTO of the indicated documents, characterized by the applicant, and including page counts, where applicable. It serves as evidence of receipt similar to a Post Card, as described in MPEP 503.**

**New Applications Under 35 U.S.C. 111**

**If a new application is being filed and the application includes the necessary components for a filing date (see 37 CFR 1.53(b)-(d) and MPEP 506), a Filing Receipt (37 CFR 1.54) will be issued in due course and the date shown on this Acknowledgement Receipt will establish the filing date of the application.**

**National Stage of an International Application under 35 U.S.C. 371**

**If a timely submission to enter the national stage of an international application is compliant with the conditions of 35 U.S.C. 371 and other applicable requirements a Form PCT/DO/EO/903 indicating acceptance of the application as a national stage submission under 35 U.S.C. 371 will be issued in addition to the Filing Receipt, in due course.**

**New International Application Filed with the USPTO as a Receiving Office**

**If a new international application is being filed and the international application includes the necessary components for an international filing date (see PCT Article 11 and MPEP 1810), a Notification of the International Application Number and of the International Filing Date (Form PCT/RO/105) will be issued in due course, subject to prescriptions concerning national security, and the date shown on this Acknowledgement Receipt will establish the international filing date of the application.**



IN THE UNITED STATES PATENT AND TRADEMARK OFFICE

In re application of:

William Grecia

Application No.: 13/740,086

Filed: January 11, 2013

For: PERSONALIZED DIGITAL MEDIA

ACCESS SYSTEM – PDMAS PART II

Examiner: N/A

Art Unit: 2431

CNF# 7081

**PRELIMINARY AMENDMENT**

Assistant Commissioner for Patents

P. O. Box 1450

Alexandria VA, 22313-1450

Sir:

This is a corrected and replacement preliminary amendment to the previously submitted amended claims 1-30 submitted on 1-30-2013. No new matter has been added to the claims by way of this amendment within the review and best knowledge of the applicant.

IN THE CLAIMS:

Please replace all of the previously submitted versions of claims 1-30 with this amended version of claims 1-30 labeled as (Currently amended) and (Original).

Respectfully Submitted:

/william grecia/

William Grecia

Applicant Pro Se

Claims:

1. (Currently amended) A method for monitoring access to an internet connected data source using a cloud system, the cloud system comprising connected modules in operation as one or more of a cloud computing or a cloud storage in connection with devices and users enablers, wherein the internet connected data source comprises one or more of a machine, video, audio, container, format, document, credit card information, personal information, textual information, image, advertisement, logo, tag, message, url, video game, software, downloadable program, content provider, service provider, or other computer based apparatus in which processed data is facilitated, the data being one of encrypted or not encrypted, the method facilitating access rights between a plurality of data processing devices, the method comprising:

receiving the internet connected data source access request from at least one communications console of the plurality of data processing devices, the access request being a read or write request of metadata of the internet connected data source, wherein the read or write request of metadata is performed in connection with a combination of at least one device and the cloud system, the request comprising a verification token provided by a first user corresponding to the internet connected data source, wherein the verification token is one or more of a password, e-mail address, payment system, credit card, authorize ready device, rights token, or one or more redeemable instruments of trade;

authenticating the verification token;

establishing a connection with the at least one communications console, wherein the communications console is a combination of a graphic user interface (GUI) and an Applications Programmable Interface (API);

requesting at least one reference from the at least one communications console, wherein the reference comprises ~~is~~ one or more of a web service account identifier, letter, number, rights token, e-mail, password, access time, serial number, address, manufacturer identification, checksum, file, circuit, operating system version, browser version, credential, cookie, key, or ID;

receiving the at least one reference from the at least one communications console; and

writing at least one of the verification token or the reference into the metadata.

2. (Currently amended) The method according to claim 1, wherein the access request being a request from the first user ~~an excelsior enabler~~ through a data processing device of the plurality of data processing devices; or

wherein the access request being a request from one or more secondary users ~~enablers~~ in network to the first user ~~excelsior enabler~~;

wherein said enablers are validated by a membership web service.

3. (Original) The method according to claim 2, wherein the metadata comprises one or more of a software or contents of a web page.

4. (Currently amended) The method according to claim 3, wherein the verification token represents verification from a provider of the token to grant access rights to the user ~~enabler~~.

5. (Currently amended) The method according to claim 4, wherein the internet connected data source is shared among one or more users ~~enablers~~ according to a membership status.

6. (Currently amended) The method according to claim 5, wherein the one or more users ~~enablers~~ are a network of recognized human beings using machines or recognized automated computerized mechanisms programmed by human beings, the recognition of said users ~~enablers~~ being validated by the membership status of the membership web service.

7. (Currently amended) The method according to claim 6, wherein the internet connected data source access request is from a user ~~an enabler~~ using a computer or a phone hosting an operating system running an application.

8. (Currently amended) The method of claim 7, wherein said verification token comprises at least one token selected from the group consisting of a purchase permission, a rental permission, or a membership permission;

wherein said permission is represented by one or more of a letter, number, combination of letters and numbers, rights token, successful payment reference, phrase, name, membership credentials, image, logo, tag, service name, authorization, list, interface button, downloadable program, or an instrument of trade.

9. (Currently amended) A system for monitoring access to an internet connected data source using a worldwide cloud system infrastructure, the worldwide cloud system infrastructure comprising connected modules in operation as computing and storage, the computing and storage comprising a server, a database, ~~a device~~ devices and users ~~an enabler~~, wherein the internet connected data source comprises one or more of a

machine, video, audio, container, format, document, credit card information, personal information, textual information, image, advertisement, logo, tag, message, url, video game, software, downloadable program, content provider, service provider, or other computer based apparatus in which processed data is facilitated, the data being one of encrypted or not encrypted, the system facilitating access rights between a plurality of data processing devices, the system working as a front-end agent for access rights authentication between the plurality of data processing devices, ~~said~~ the system further comprising:

a first receipt module, the first receipt module receiving the internet connected data source access request from at least one communications console of the plurality of data processing devices, the access request being a read or write request of metadata of the internet connected data source, wherein the read or write request of metadata is performed in connection with a combination of a device, the server, the database and the cloud system, the metadata further comprises one or more of a software or contents of a web page, the request comprising a verification token provided by a user corresponding to the internet connected data source, wherein the verification token is one or more of a password, e-mail address, payment system, credit card, authorize ready device, rights token, or one or more redeemable instruments of trade;

an authentication module, the authentication module authenticating the verification token;

a connection module, the connection module establishing a connection with the at least one communications console, wherein the communications console is a

combination of a graphic user interface (GUI) and an Applications Programmable Interface (API);

a request module, the request module requesting at least one reference from the at least one communications console, wherein the reference comprises ~~is~~ one or more of a web service account identifier, letter, number, rights token, e-mail, password, access time, serial number, address, manufacturer identification, checksum, file, circuit, operating system version, browser version, credential, cookie, key, or ID;

a secondary receipt module, the secondary receipt module receiving the at least one reference from the at least one communications console; and

a branding module, the branding module writing at least one of the verification token or the reference into the metadata.

10. (Currently amended) The system of claim 9, wherein the ~~said~~-verification token comprises at least one token selected from the group consisting of a purchase permission, a rental permission, or a membership permission;

Wherein the ~~said~~-permission is represented by one or more of a tag, letter, number, combination of letters and numbers, rights token, successful payment reference, phrase, name, membership credentials, image, logo, service name, authorization, list, interface button, downloadable program, or an instrument of trade.

11. (Currently amended) An operating system software program for use with at least one data processing device of a plurality of data processing devices, the data processing device hosting at least one operating system software version of a plurality of operating system software versions, the data processing device comprising a non-transitory usable medium storing the operating system software comprising a program

code, the program code being a part of the operating system software or downloaded in sections from a web server, the operating system software program coupled with a user ~~an enabler~~ executing a method for monitoring access to a non-public internet connected asset using a cloud system, the cloud system comprising internet connected modules comprising storage and computing, the method facilitating a data exchange session between a combination of the user ~~enabler~~ in operation of the data processing device and the cloud system, the data exchange session establishing an access permission for the internet connected asset, wherein the internet connected asset comprises one or more of a machine, video, audio, container, format, document, credit card information, personal information, textual information, image, advertisement, logo, tag, message, url, video game, software, downloadable program, content provider, service provider, or other computer based apparatus in which processed data is facilitated, the operating system software program coupled with the enabler performing the method steps of:

receiving the internet connected asset access request from at least one communications console of the plurality of data processing devices, the access request being a read or write request of metadata of the internet connected asset, wherein the read or write request of metadata is performed in connection with a combination of the operating system software program and the cloud system, the request comprising a verification token provided by the user corresponding to the internet connected asset, wherein the verification token is one or more of a password, e-mail address, payment system, credit card, authorize ready device, rights token, key, file, or one or more redeemable instruments of trade;

authenticating the verification token;

establishing a connection with the at least one communications console, wherein the communications console is a combination of a graphic user interface (GUI) and an Applications Programmable Interface (API);

requesting at least one reference from the at least one communications console, wherein the reference is one or more of a web service account identifier, letter, number, rights token, e-mail, password, access time, serial number, address, manufacturer identification, checksum, file, circuit, operating system version, browser version, credential, cookie, key, or ID;

receiving the at least one reference from the at least one communications console; and

writing at least one of the verification token or the reference into the metadata.

12. (Currently amended) The operating system software program according to claim 11, wherein the access request is a request from the user enabler providing a credential to a membership web service through a data processing device of the plurality of data processing devices, the user enabler being a human user establishing a permission to the internet connected asset.

13. (Currently amended) The operating system software program of claim 12, wherein the verification token comprises at least one of a purchase permission, a rental permission, or a membership permission;

Wherein the said permission is represented by one or more of a tag, letter, number, combination of letters and numbers, successful payment reference, phrase, name, membership credential, image, logo, service name, authorization, list, key, file, interface button, downloadable program, or an instrument of trade.



14. (Original) The operating system software program according to claim 13, wherein the verification token represents verification from a provider that a product was acquired.
15. (Original) The operating system software program according to claim 13, wherein the internet connected asset is accessed according to a membership status.
16. (Original) The operating system software program according to claim 15, wherein the membership status is connected to an application programmable interface.
17. (Original) The operating system software program according to claim 15, wherein a remote control operation exist.
18. (Original) The operating system software program according to claim 16, wherein the application programmable interface is connected to a graphic user interface.
19. (Original) The operating system software program according to claim 17, wherein the internet connected asset is shared with one or more secondary users.
20. (Original) The operating system software program according to claim 19, wherein the internet connected asset is shared with the secondary user according to a period of time.
21. (Currently amended) A computer product comprising a memory, a CPU, a communications console and a non-transitory computer usable medium, the computer usable medium having an operating system stored therein, the computer product further comprising a customization module, the computer product coupled with a user ~~an enabler~~ executing a method for monitoring access to a data source, wherein the data source is one of an application, a video, a video game, or a software, wherein the data source ~~is being~~ one of a local or an internet connected, wherein the data source is one

of encrypted or not encrypted, the computer product coupled with the user ~~said enabler~~ performing the method steps of:

receiving the data source access request from the communications console, the access request being a read or write request of metadata of the data source, the metadata of the data source being one or more of a database or storage in connection to the computer product, the request comprising a verification token corresponding to the data source, the verification token is handled by the user ~~enabler~~ as a redeemable instrument, wherein the verification token comprises at least one of a purchase permission, a rental permission, or a membership permission, the permission being represented by one or more of a tag, a letter, a number, a combination of letters and numbers, a successful payment, a rights token, a phrase, a name, a membership credential, an image, a logo, a service name, an authorization, a list, an interface button, a downloadable program, or the redeemable instrument;

authenticating the verification token;

establishing a connection with the communications console, wherein the communications console comprises a data exchange session, wherein the data exchange session comprises at least one reference;

requesting the at least one reference from the communications console, wherein the reference is one or more of a web service account identifier, letter, number, rights token, e-mail, password, access time, serial number, address, manufacturer identification, checksum, file, circuit, operating system version, browser version, credential, cookie, key, or ID;

receiving the at least one reference from the communications console; and

writing at least one of the verification token or the reference into the said metadata.

22. (Currently amended) The computer product according to claim 21, wherein the access request is a request from a first user ~~an excelsior enabler~~, the first user ~~excelsior enabler~~ is a human user in operation of the computer product and establishes first access to the data source; or

wherein the access request is a request from a secondary user ~~enabler~~, the secondary user ~~enabler~~ is a human user in operation of the computer product and establishes secondary access to the same data source as first established for access by the first user ~~excelsior enabler~~.

23. (Original) The computer product according to claim 21, wherein the customization module customizes the tag.

24. (Original) The computer product according to claim 21, wherein the customization module customizes a user access panel.

25. (Currently amended) The computer product according to claim 22, wherein a data source is monitored for access using a worldwide cloud system infrastructure, the worldwide cloud system infrastructure comprising internet connected modules in operation as computing and storage services in connection to the computer product.

26. (Original) The computer product according to claim 22, wherein the verification token is connected to a royalty scheme.

27. (Currently amended) The computer product according to claim 25, wherein the access is allowed according to a permission facilitated by a web service ~~connected~~ working as a front-end agent to the worldwide cloud system infrastructure.

28. (Currently amended) The computer product according to claim 25, wherein the computer product is a device of a plurality of devices in a network of the user-enabler.

29. (Original) The computer product according to claim 28, wherein the device is a computer or a phone.

30. (Original) The computer product according to claim 29, wherein a remote control operation exist.

## Electronic Acknowledgement Receipt

<b>EFS ID:</b>	14842822
<b>Application Number:</b>	13740086
<b>International Application Number:</b>	
<b>Confirmation Number:</b>	7081
<b>Title of Invention:</b>	PERSONALIZED DIGITAL MEDIA ACCESS SYSTEM - PDMAS PART II
<b>First Named Inventor/Applicant Name:</b>	William Grecia
<b>Customer Number:</b>	70984
<b>Filer:</b>	William Grecia
<b>Filer Authorized By:</b>	
<b>Attorney Docket Number:</b>	
<b>Receipt Date:</b>	31-JAN-2013
<b>Filing Date:</b>	
<b>Time Stamp:</b>	14:41:45
<b>Application Type:</b>	Utility under 35 USC 111(a)

### Payment information:

Submitted with Payment	no
------------------------	----

### File Listing:

Document Number	Document Description	File Name	File Size(Bytes)/ Message Digest	Multi Part /.zip	Pages (if appl.)
1	Preliminary Amendment	PDMASII-claim-am-crrctm.pdf	195878 22c681e530a092593eb6358371bd36b124408c11	no	12

### Warnings:

### Information:

EWS-003899

This Acknowledgement Receipt evidences receipt on the noted date by the USPTO of the indicated documents, characterized by the applicant, and including page counts, where applicable. It serves as evidence of receipt similar to a Post Card, as described in MPEP 503.

**New Applications Under 35 U.S.C. 111**

If a new application is being filed and the application includes the necessary components for a filing date (see 37 CFR 1.53(b)-(d) and MPEP 506), a Filing Receipt (37 CFR 1.54) will be issued in due course and the date shown on this Acknowledgement Receipt will establish the filing date of the application.

**National Stage of an International Application under 35 U.S.C. 371**

If a timely submission to enter the national stage of an international application is compliant with the conditions of 35 U.S.C. 371 and other applicable requirements a Form PCT/DO/EO/903 indicating acceptance of the application as a national stage submission under 35 U.S.C. 371 will be issued in addition to the Filing Receipt, in due course.

**New International Application Filed with the USPTO as a Receiving Office**

If a new international application is being filed and the international application includes the necessary components for an international filing date (see PCT Article 11 and MPEP 1810), a Notification of the International Application Number and of the International Filing Date (Form PCT/RO/105) will be issued in due course, subject to prescriptions concerning national security, and the date shown on this Acknowledgement Receipt will establish the international filing date of the application.

IN THE UNITED STATES PATENT AND TRADEMARK OFFICE

In re application of:

William Grecia

Application No.: 13/740,086

Filed: January 11, 2013

For: PERSONALIZED DIGITAL MEDIA

ACCESS SYSTEM – PDMAS PART II

Examiner: N/A

Art Unit: 2431

CNF# 7081

**PRELIMINARY AMENDMENT**

Assistant Commissioner for Patents

P. O. Box 1450

Alexandria VA, 22313-1450

Sir:

This is a preliminary amendment to the previously submitted claims 1-30. No new matter has been added to the claims by way of this amendment within the review and best knowledge of the applicant.

IN THE CLAIMS:

Please replace all of the previously submitted versions of claims 1-30 with this amended version of claims 1-30 labeled as (Currently amended) and (Original).

Respectfully Submitted:

/william grecia/

William Grecia

Applicant Pro Se

Claims:

1. (Currently amended) A method for monitoring access to an internet connected data source using a cloud system, the cloud system comprising connected modules in operation as one or more of a cloud computing or a cloud storage in connection with devices and users enablers, wherein the internet connected data source comprises one or more of a machine, video, audio, container, format, document, credit card information, personal information, textual information, image, advertisement, logo, tag, message, url, video game, software, downloadable program, content provider, service provider, or other computer based apparatus in which processed data is facilitated, the data being one of encrypted or not encrypted, the method facilitating access rights between a plurality of data processing devices, the method comprising:

receiving the internet connected data source access request from at least one communications console of the plurality of data processing devices, the access request being a read or write request of metadata of the internet connected data source, wherein the read or write request of metadata is performed in connection with a combination of at least one device and the cloud system, the request comprising a verification token provided by a first user, corresponding to the internet connected data source, wherein the verification token is one or more of a password, e-mail address, payment system, credit card, authorize ready device, rights token, or one or more redeemable instruments of trade;

authenticating the verification token;



establishing a connection with the at least one communications console, wherein the communications console is a combination of a graphic user interface (GUI) and an Applications Programmable Interface (API);

requesting at least one reference from the at least one communications console, wherein the reference comprises ~~is~~ one or more of a web service account identifier, letter, number, rights token, e-mail, password, access time, serial number, address, manufacturer identification, checksum, file, circuit, operating system version, browser version, credential, cookie, key, or ID;

receiving the at least one reference from the at least one communications console; and

writing at least one of the verification token or the reference into the metadata.

2. (Currently amended) The method according to claim 1, wherein the access request being a request from the first user ~~an excelsior enabler~~ through a data processing device of the plurality of data processing devices; or

wherein the access request being a request from one or more secondary users ~~enablers~~ in network to the first user ~~excelsior enabler~~;

wherein said enablers are validated by a membership web service.

3. (Original) The method according to claim 2, wherein the metadata comprises one or more of a software or contents of a web page.

4. (Currently amended) The method according to claim 3, wherein the verification token represents verification from a provider of the token to grant access rights to the user ~~enabler~~.

5. (Currently amended) The method according to claim 4, wherein the internet connected data source is shared among one or more users ~~enablers~~ according to a membership status.

6. (Currently amended) The method according to claim 5, wherein the one or more users ~~enablers~~ are a network of recognized human beings using machines or recognized automated computerized mechanisms programmed by human beings, the recognition of said users ~~enablers~~ being validated by the membership status of the membership web service.

7. (Currently amended) The method according to claim 6, wherein the internet connected data source access request is from a user ~~an enabler~~ using a computer or a phone hosting an operating system running an application.

8. (Currently amended) The method of claim 7, wherein said verification token comprises at least one token selected from the group consisting of a purchase permission, a rental permission, or a membership permission;

wherein said permission is represented by one or more of a letter, number, combination of letters and numbers, rights token, successful payment reference, phrase, name, membership credentials, image, logo, tag, service name, authorization, list, interface button, downloadable program, or an instrument of trade.

9. (Currently amended) A system for monitoring access to an internet connected data source using a worldwide cloud system infrastructure, the worldwide cloud system infrastructure comprising connected modules in operation as computing and storage, the computing and storage comprising a server, a database, ~~a device~~ devices and users ~~an enabler~~, wherein the internet connected data source comprises one or more of a

machine, video, audio, container, format, document, credit card information, personal information, textual information, image, advertisement, logo, tag, message, url, video game, software, downloadable program, content provider, service provider, or other computer based apparatus in which processed data is facilitated, the data being one of encrypted or not encrypted, the system facilitating access rights between a plurality of data processing devices, the system working as a front-end agent for access rights authentication between the plurality of data processing devices, ~~said~~ the system further comprising:

a first receipt module, the first receipt module receiving the internet connected data source access request from at least one communications console of the plurality of data processing devices, the access request being a read or write request of metadata of the internet connected data source, wherein the read or write request of metadata is performed in connection with a combination of a device, the server, the database and the cloud system, the metadata further comprises one or more of a software or contents of a web page, the request comprising a verification token provided by a user, corresponding to the internet connected data source, wherein the verification token is one or more of a password, e-mail address, payment system, credit card, authorize ready device, rights token, or one or more redeemable instruments of trade;

an authentication module, the authentication module authenticating the verification token;

a connection module, the connection module establishing a connection with the at least one communications console, wherein the communications console is a

combination of a graphic user interface (GUI) and an Applications Programmable Interface (API);

a request module, the request module requesting at least one reference from the at least one communications console, wherein the reference comprises ~~is~~ one or more of a web service account identifier, letter, number, rights token, e-mail, password, access time, serial number, address, manufacturer identification, checksum, file, circuit, operating system version, browser version, credential, cookie, key, or ID;

a secondary receipt module, the secondary receipt module receiving the at least one reference from the at least one communications console; and

a branding module, the branding module writing at least one of the verification token or the reference into the metadata.

10. (Currently amended) The system of claim 9, wherein the ~~said~~-verification token comprises at least one token selected from the group consisting of a purchase permission, a rental permission, or a membership permission;

Wherein the ~~said~~-permission is represented by one or more of a tag, letter, number, combination of letters and numbers, rights token, successful payment reference, phrase, name, membership credentials, image, logo, service name, authorization, list, interface button, downloadable program, or an instrument of trade.

11. (Currently amended) An operating system software program for use with at least one data processing device of a plurality of data processing devices, the data processing device hosting at least one operating system software version of a plurality of operating system software versions, the data processing device comprising a non-transitory usable medium storing the operating system software comprising a program

code, the program code being a part of the operating system software or downloaded in sections from a web server, the operating system software program coupled with a user ~~an enabler~~ executing a method for monitoring access to a non-public internet connected asset using a cloud system, the cloud system comprising internet connected modules comprising storage and computing, the method facilitating a data exchange session between a combination of the user ~~enabler~~ in operation of the data processing device and the cloud system, the data exchange session establishing an access permission for the internet connected asset, wherein the internet connected asset comprises one or more of a machine, video, audio, container, format, document, credit card information, personal information, textual information, image, advertisement, logo, tag, message, url, video game, software, downloadable program, content provider, service provider, or other computer based apparatus in which processed data is facilitated, the operating system software program coupled with the enabler performing the method steps of:

receiving the internet connected asset access request from at least one communications console of the plurality of data processing devices, the access request being a read or write request of metadata of the internet connected asset, wherein the read or write request of metadata is performed in connection with a combination of the operating system software program and the cloud system, the request comprising a verification token provided by the user, corresponding to the internet connected asset, wherein the verification token is one or more of a password, e-mail address, payment system, credit card, authorize ready device, rights token, key, file, or one or more redeemable instruments of trade;

authenticating the verification token;

establishing a connection with the at least one communications console, wherein the communications console is a combination of a graphic user interface (GUI) and an Applications Programmable Interface (API);

requesting at least one reference from the at least one communications console, wherein the reference is one or more of a web service account identifier, letter, number, rights token, e-mail, password, access time, serial number, address, manufacturer identification, checksum, file, circuit, operating system version, browser version, credential, cookie, key, or ID;

receiving the at least one reference from the at least one communications console; and

writing at least one of the verification token or the reference into the metadata.

12. (Currently amended) The operating system software program according to claim 11, wherein the access request is a request from the user enabler—providing a credential to a membership web service through a data processing device of the plurality of data processing devices, the user enabler—being a human user establishing a permission to the internet connected asset.

13. (Currently amended) The operating system software program of claim 12, wherein the verification token comprises at least one of a purchase permission, a rental permission, or a membership permission;

Wherein the said—permission is represented by one or more of a tag, letter, number, combination of letters and numbers, successful payment reference, phrase, name, membership credential, image, logo, service name, authorization, list, key, file, interface button, downloadable program, or an instrument of trade.

14. (Original) The operating system software program according to claim 13, wherein the verification token represents verification from a provider that a product was acquired.
15. (Original) The operating system software program according to claim 13, wherein the internet connected asset is accessed according to a membership status.
16. (Original) The operating system software program according to claim 15, wherein the membership status is connected to an application programmable interface.
17. (Original) The operating system software program according to claim 15, wherein a remote control operation exist.
18. (Original) The operating system software program according to claim 16, wherein the application programmable interface is connected to a graphic user interface.
19. (Original) The operating system software program according to claim 17, wherein the internet connected asset is shared with one or more secondary users.
20. (Original) The operating system software program according to claim 19, wherein the internet connected asset is shared with the secondary user according to a period of time.
21. (Currently amended) A computer product comprising a memory, a CPU, a communications console and a non-transitory computer usable medium, the computer usable medium having an operating system stored therein, the computer product further comprising a customization module, the computer product coupled with a user ~~an enabler~~ executing a method for monitoring access to a data source, wherein the data source is one of an application, a video, a video game, or a software, wherein the data source ~~is being~~ one of a local or an internet connected, wherein the data source is one

of encrypted or not encrypted, the computer product coupled with the user ~~said enabler~~ performing the method steps of:

receiving the data source access request from the communications console, the access request being a read or write request of metadata of the data source, the metadata of the data source being one or more of a database or storage in connection to the computer product, the request comprising a verification token corresponding to the data source, the verification token is handled by the user ~~enabler~~ as a redeemable instrument, wherein the verification token comprises at least one of a purchase permission, a rental permission, or a membership permission, the permission being represented by one or more of a tag, a letter, a number, a combination of letters and numbers, a successful payment, a rights token, a phrase, a name, a membership credential, an image, a logo, a service name, an authorization, a list, an interface button, a downloadable program, or the redeemable instrument;

authenticating the verification token;

establishing a connection with the communications console, wherein the communications console comprises a data exchange session, wherein the data exchange session comprises at least one reference;

requesting the at least one reference from the communications console, wherein the reference is one or more of a web service account identifier, letter, number, rights token, e-mail, password, access time, serial number, address, manufacturer identification, checksum, file, circuit, operating system version, browser version, credential, cookie, key, or ID;

receiving the at least one reference from the communications console; and



writing at least one of the verification token or the reference into the said metadata.

22. (Currently amended) The computer product according to claim 21, wherein the access request is a request from a first user ~~an excelsior enabler~~, the first user ~~excelsior enabler~~ is a human user in operation of the computer product and establishes first access to the data source; or

wherein the access request is a request from a secondary user ~~enabler~~, the secondary user ~~enabler~~ is a human user in operation of the computer product and establishes secondary access to the same data source as first established for access by the first user ~~excelsior enabler~~.

23. (Original) The computer product according to claim 21, wherein the customization module customizes the tag.

24. (Original) The computer product according to claim 21, wherein the customization module customizes a user access panel.

25. (Currently amended) The computer product according to claim 22, wherein a data source is monitored for access using a worldwide cloud system infrastructure, the worldwide cloud system infrastructure comprising internet connected modules in operation as computing and storage services in connection to the computer product.

26. (Original) The computer product according to claim 22, wherein the verification token is connected to a royalty scheme.

27. (Currently amended) The computer product according to claim 25, wherein the access is allowed according to a permission facilitated by a web service ~~connected~~ working as a front-end agent to the worldwide cloud system infrastructure.

28. (Currently amended) The computer product according to claim 25, wherein the computer product is a device of a plurality of devices in a network of the user-enabler.

29. (Original) The computer product according to claim 28, wherein the device is a computer or a phone.

30. (Original) The computer product according to claim 29, wherein a remote control operation exist.

## Electronic Acknowledgement Receipt

<b>EFS ID:</b>	14825793
<b>Application Number:</b>	13740086
<b>International Application Number:</b>	
<b>Confirmation Number:</b>	7081
<b>Title of Invention:</b>	PERSONALIZED DIGITAL MEDIA ACCESS SYSTEM - PDMAS PART II
<b>First Named Inventor/Applicant Name:</b>	William Grecia
<b>Customer Number:</b>	70984
<b>Filer:</b>	William Grecia
<b>Filer Authorized By:</b>	
<b>Attorney Docket Number:</b>	
<b>Receipt Date:</b>	30-JAN-2013
<b>Filing Date:</b>	
<b>Time Stamp:</b>	00:06:28
<b>Application Type:</b>	Utility under 35 USC 111(a)

### Payment information:

Submitted with Payment	no
------------------------	----

### File Listing:

Document Number	Document Description	File Name	File Size(Bytes)/ Message Digest	Multi Part /.zip	Pages (if appl.)
1	Preliminary Amendment	PDMASII-claim-amac.pdf	201145 <small>ec9800517aabf402d5a96e9e0f0ff62415029462</small>	no	12

### Warnings:

### Information:

EWS-003913

**This Acknowledgement Receipt evidences receipt on the noted date by the USPTO of the indicated documents, characterized by the applicant, and including page counts, where applicable. It serves as evidence of receipt similar to a Post Card, as described in MPEP 503.**

**New Applications Under 35 U.S.C. 111**

**If a new application is being filed and the application includes the necessary components for a filing date (see 37 CFR 1.53(b)-(d) and MPEP 506), a Filing Receipt (37 CFR 1.54) will be issued in due course and the date shown on this Acknowledgement Receipt will establish the filing date of the application.**

**National Stage of an International Application under 35 U.S.C. 371**

**If a timely submission to enter the national stage of an international application is compliant with the conditions of 35 U.S.C. 371 and other applicable requirements a Form PCT/DO/EO/903 indicating acceptance of the application as a national stage submission under 35 U.S.C. 371 will be issued in addition to the Filing Receipt, in due course.**

**New International Application Filed with the USPTO as a Receiving Office**

**If a new international application is being filed and the international application includes the necessary components for an international filing date (see PCT Article 11 and MPEP 1810), a Notification of the International Application Number and of the International Filing Date (Form PCT/RO/105) will be issued in due course, subject to prescriptions concerning national security, and the date shown on this Acknowledgement Receipt will establish the international filing date of the application.**

<b>INFORMATION DISCLOSURE STATEMENT BY APPLICANT</b> ( Not for submission under 37 CFR 1.99)	Application Number		13740086
	Filing Date		2013-01-11
	First Named Inventor	William Grecia	
	Art Unit		2431
	Examiner Name		
	Attorney Docket Number		

U.S.PATENTS						Remove
Examiner Initial*	Cite No	Patent Number	Kind Code <sup>1</sup>	Issue Date	Name of Patentee or Applicant of cited Document	Pages,Columns,Lines where Relevant Passages or Relevant Figures Appear
	1	8250145		2012-08-21	Zuckerberg; Mark	
	2	8280959		2012-10-02	Zuckerberg; Mark	

If you wish to add additional U.S. Patent citation information please click the Add button.

Add

U.S.PATENT APPLICATION PUBLICATIONS						Remove
Examiner Initial*	Cite No	Publication Number	Kind Code <sup>1</sup>	Publication Date	Name of Patentee or Applicant of cited Document	Pages,Columns,Lines where Relevant Passages or Relevant Figures Appear
	1	20110208695		2011-08-25	Anand; Siddharth	
	2	20110265157		2011-10-27	Ryder; Scott	
	3	20110313898		2011-12-22	Singhal; Nitesh	
	4	20110320345		2011-12-29	Taveau; Sebastien	

**INFORMATION DISCLOSURE  
STATEMENT BY APPLICANT**  
( Not for submission under 37 CFR 1.99)

Application Number	13740086
Filing Date	2013-01-11
First Named Inventor	William Grecia
Art Unit	2431
Examiner Name	
Attorney Docket Number	

5	20120041829		2012-02-16	Rothschild; Keith Alan	
6	20120130903		2012-03-24	Dorsey; Jack	
7	20120079095		2012-03-29	Evans; Ethan	
8	20120079126		2012-03-29	Evans; Ethan	
9	20120079276		2012-03-29	Evans; Ethan	
10	20120079606		2012-03-29	Evans; Ethan	
11	20120095916		2012-04-19	Dorsey; Jack	
12	20120095906		2012-04-19	Dorsey; Jack	
13	20120095871		2012-04-19	Dorsey; Jack	
14	20120150727		2012-06-14	Nuzzi; Frank Anthony	
15	20120166333		2012-06-28	von Behren; Rob	

**INFORMATION DISCLOSURE  
STATEMENT BY APPLICANT**  
( Not for submission under 37 CFR 1.99)

Application Number	13740086
Filing Date	2013-01-11
First Named Inventor	William Grecia
Art Unit	2431
Examiner Name	
Attorney Docket Number	

16	20120173333		2012-07-05	Berger; Richard	
17	20120173625		2012-07-05	Berger; Richard	
18	20120173431		2012-07-05	Ritchie; Ben	
19	20120191553		2012-07-26	Sathe; Nikhil S	
20	20110208695		2011-08-25	Anand; Siddharth	
21	20120254340		2012-10-04	Velummylum; Piragash	
22	20120255033		2012-10-04	Dwivedi; Sanjeev	
23	20120290376		2012-11-15	Dryer; Trevor D.	
24	20120296741		2012-11-22	Dykes; Robert	
25	20120310828		2012-12-06	Hu; Qilin	
26	20110313898		2011-12-22	Singhal; Nitesh	

**INFORMATION DISCLOSURE  
STATEMENT BY APPLICANT**  
( Not for submission under 37 CFR 1.99)

Application Number	13740086
Filing Date	2013-01-11
First Named Inventor	William Grecia
Art Unit	2431
Examiner Name	
Attorney Docket Number	

27	20110320345		2011-12-29	Taveau; Sebastien	
28	20130007892		2013-01-03	Inooka, Hidehiro	

If you wish to add additional U.S. Published Application citation information please click the Add button. **Add**

**FOREIGN PATENT DOCUMENTS**

**Remove**

Examiner Initial*	Cite No	Foreign Document Number <sup>3</sup>	Country Code <sup>2</sup> j	Kind Code <sup>4</sup>	Publication Date	Name of Patentee or Applicant of cited Document	Pages, Columns, Lines where Relevant Passages or Relevant Figures Appear	T <sup>5</sup>
	1							<input type="checkbox"/>

If you wish to add additional Foreign Patent Document citation information please click the Add button **Add**

**NON-PATENT LITERATURE DOCUMENTS**

**Remove**

Examiner Initials*	Cite No	Include name of the author (in CAPITAL LETTERS), title of the article (when appropriate), title of the item (book, magazine, journal, serial, symposium, catalog, etc), date, pages(s), volume-issue number(s), publisher, city and/or country where published.	T <sup>5</sup>
	1		<input type="checkbox"/>

If you wish to add additional non-patent literature document citation information please click the Add button **Add**

**EXAMINER SIGNATURE**

Examiner Signature		Date Considered	
--------------------	--	-----------------	--

\*EXAMINER: Initial if reference considered, whether or not citation is in conformance with MPEP 609. Draw line through a citation if not in conformance and not considered. Include copy of this form with next communication to applicant.

<sup>1</sup> See Kind Codes of USPTO Patent Documents at [www.USPTO.GOV](http://www.USPTO.GOV) or MPEP 901.04. <sup>2</sup> Enter office that issued the document, by the two-letter code (WIPO Standard ST.3). <sup>3</sup> For Japanese patent documents, the indication of the year of the reign of the Emperor must precede the serial number of the patent document. <sup>4</sup> Kind of document by the appropriate symbols as indicated on the document under WIPO Standard ST.16 if possible. <sup>5</sup> Applicant is to place a check mark here if English language translation is attached.



**INFORMATION DISCLOSURE  
STATEMENT BY APPLICANT**  
( Not for submission under 37 CFR 1.99)

Application Number	13740086		
Filing Date	2013-01-11		
First Named Inventor	William Grecia		
Art Unit	2431		
Examiner Name			
Attorney Docket Number			

**CERTIFICATION STATEMENT**

Please see 37 CFR 1.97 and 1.98 to make the appropriate selection(s):

That each item of information contained in the information disclosure statement was first cited in any communication from a foreign patent office in a counterpart foreign application not more than three months prior to the filing of the information disclosure statement. See 37 CFR 1.97(e)(1).

**OR**

That no item of information contained in the information disclosure statement was cited in a communication from a foreign patent office in a counterpart foreign application, and, to the knowledge of the person signing the certification after making reasonable inquiry, no item of information contained in the information disclosure statement was known to any individual designated in 37 CFR 1.56(c) more than three months prior to the filing of the information disclosure statement. See 37 CFR 1.97(e)(2).

See attached certification statement.

The fee set forth in 37 CFR 1.17 (p) has been submitted herewith.

A certification statement is not submitted herewith.

**SIGNATURE**

A signature of the applicant or representative is required in accordance with CFR 1.33, 10.18. Please see CFR 1.4(d) for the form of the signature.

Signature	/william grecia/	Date (YYYY-MM-DD)	2013-01-11
Name/Print	William Grecia	Registration Number	70984

This collection of information is required by 37 CFR 1.97 and 1.98. The information is required to obtain or retain a benefit by the public which is to file (and by the USPTO to process) an application. Confidentiality is governed by 35 U.S.C. 122 and 37 CFR 1.14. This collection is estimated to take 1 hour to complete, including gathering, preparing and submitting the completed application form to the USPTO. Time will vary depending upon the individual case. Any comments on the amount of time you require to complete this form and/or suggestions for reducing this burden, should be sent to the Chief Information Officer, U.S. Patent and Trademark Office, U.S. Department of Commerce, P.O. Box 1450, Alexandria, VA 22313-1450. **DO NOT SEND FEES OR COMPLETED FORMS TO THIS ADDRESS. SEND TO: Commissioner for Patents, P.O. Box 1450, Alexandria, VA 22313-1450.**

## Privacy Act Statement

The Privacy Act of 1974 (P.L. 93-579) requires that you be given certain information in connection with your submission of the attached form related to a patent application or patent. Accordingly, pursuant to the requirements of the Act, please be advised that: (1) the general authority for the collection of this information is 35 U.S.C. 2(b)(2); (2) furnishing of the information solicited is voluntary; and (3) the principal purpose for which the information is used by the U.S. Patent and Trademark Office is to process and/or examine your submission related to a patent application or patent. If you do not furnish the requested information, the U.S. Patent and Trademark Office may not be able to process and/or examine your submission, which may result in termination of proceedings or abandonment of the application or expiration of the patent.

The information provided by you in this form will be subject to the following routine uses:

1. The information on this form will be treated confidentially to the extent allowed under the Freedom of Information Act (5 U.S.C. 552) and the Privacy Act (5 U.S.C. 552a). Records from this system of records may be disclosed to the Department of Justice to determine whether the Freedom of Information Act requires disclosure of these records.
2. A record from this system of records may be disclosed, as a routine use, in the course of presenting evidence to a court, magistrate, or administrative tribunal, including disclosures to opposing counsel in the course of settlement negotiations.
3. A record in this system of records may be disclosed, as a routine use, to a Member of Congress submitting a request involving an individual, to whom the record pertains, when the individual has requested assistance from the Member with respect to the subject matter of the record.
4. A record in this system of records may be disclosed, as a routine use, to a contractor of the Agency having need for the information in order to perform a contract. Recipients of information shall be required to comply with the requirements of the Privacy Act of 1974, as amended, pursuant to 5 U.S.C. 552a(m).
5. A record related to an International Application filed under the Patent Cooperation Treaty in this system of records may be disclosed, as a routine use, to the International Bureau of the World Intellectual Property Organization, pursuant to the Patent Cooperation Treaty.
6. A record in this system of records may be disclosed, as a routine use, to another federal agency for purposes of National Security review (35 U.S.C. 181) and for review pursuant to the Atomic Energy Act (42 U.S.C. 218(c)).
7. A record from this system of records may be disclosed, as a routine use, to the Administrator, General Services, or his/her designee, during an inspection of records conducted by GSA as part of that agency's responsibility to recommend improvements in records management practices and programs, under authority of 44 U.S.C. 2904 and 2906. Such disclosure shall be made in accordance with the GSA regulations governing inspection of records for this purpose, and any other relevant (i.e., GSA or Commerce) directive. Such disclosure shall not be used to make determinations about individuals.
8. A record from this system of records may be disclosed, as a routine use, to the public after either publication of the application pursuant to 35 U.S.C. 122(b) or issuance of a patent pursuant to 35 U.S.C. 151. Further, a record may be disclosed, subject to the limitations of 37 CFR 1.14, as a routine use, to the public if the record was filed in an application which became abandoned or in which the proceedings were terminated and which application is referenced by either a published application, an application open to public inspections or an issued patent.
9. A record from this system of records may be disclosed, as a routine use, to a Federal, State, or local law enforcement agency, if the USPTO becomes aware of a violation or potential violation of law or regulation.

<b>INFORMATION DISCLOSURE STATEMENT BY APPLICANT</b> ( Not for submission under 37 CFR 1.99)	Application Number	13740086
	Filing Date	2013-01-11
	First Named Inventor	William Grecia
	Art Unit	2431
	Examiner Name	Not Applicable
	Attorney Docket Number	

U.S.PATENTS						Remove
Examiner Initial*	Cite No	Patent Number	Kind Code <sup>1</sup>	Issue Date	Name of Patentee or Applicant of cited Document	Pages,Columns,Lines where Relevant Passages or Relevant Figures Appear
	1	7254235		2007-08-07	Boudreault et al.	
	2	7343014		2008-03-11	Sovio et al.	
	3	7526650		2009-04-28	Wimmer, Chris	
If you wish to add additional U.S. Patent citation information please click the Add button.						Add
U.S.PATENT APPLICATION PUBLICATIONS						Remove
Examiner Initial*	Cite No	Publication Number	Kind Code <sup>1</sup>	Publication Date	Name of Patentee or Applicant of cited Document	Pages,Columns,Lines where Relevant Passages or Relevant Figures Appear
	1	20110288946		2011-11-24	Baiya et al.	
	2	20100100899		2010-04-22	Bradbury et al.	
	3	20050065891		2005-03-24	Lee et al.	

<b>INFORMATION DISCLOSURE STATEMENT BY APPLICANT</b> ( Not for submission under 37 CFR 1.99)	Application Number		13740086	
	Filing Date		2013-01-11	
	First Named Inventor	William Grecia		
	Art Unit		2431	
	Examiner Name	Not Applicable		
	Attorney Docket Number			

4	20080010685		2008-01-10	Holtzman et al.	
5	20090083541		2009-03-26	Levine, Scott	

If you wish to add additional U.S. Published Application citation information please click the Add button. **Add**

**FOREIGN PATENT DOCUMENTS**

Remove

Examiner Initial*	Cite No	Foreign Document Number <sup>3</sup>	Country Code <sup>2</sup> i	Kind Code <sup>4</sup>	Publication Date	Name of Patentee or Applicant of cited Document	Pages, Columns, Lines where Relevant Passages or Relevant Figures Appear	T <sup>5</sup>
	1							<input type="checkbox"/>

If you wish to add additional Foreign Patent Document citation information please click the Add button **Add**

**NON-PATENT LITERATURE DOCUMENTS**

Remove

Examiner Initials*	Cite No	Include name of the author (in CAPITAL LETTERS), title of the article (when appropriate), title of the item (book, magazine, journal, serial, symposium, catalog, etc), date, pages(s), volume-issue number(s), publisher, city and/or country where published.	T <sup>5</sup>
	1	Copy of co-pending U.S. patent application #13/397,517 document reference: 2013-01-07 Examiner initiated interview summary (PTOL-413B)	<input type="checkbox"/>
	2	Copy of co-pending U.S. patent application #13/397,517 document reference: 2012-12-26 Advisory Action (PTOL-303)	<input type="checkbox"/>
	3	Copy of co-pending U.S. patent application #13/397,517 document reference: 22012-11-26 Final Rejection	<input type="checkbox"/>
	4	Copy of co-pending U.S. patent application #13/397,517 document reference: 2012-11-26 List of references cited by examiner	<input type="checkbox"/>

**INFORMATION DISCLOSURE  
STATEMENT BY APPLICANT**  
( Not for submission under 37 CFR 1.99)

Application Number		13740086
Filing Date		2013-01-11
First Named Inventor	William Grecia	
Art Unit		2431
Examiner Name	Not Applicable	
Attorney Docket Number		

5	Copy of co-pending U.S. patent application #13/397,517 document reference: 2012-11-26 List of References cited by applicant and considered by examiner	<input type="checkbox"/>
6	Liu et al. 2004 NPL - A license-sharing scheme in Digital Rights Management	<input type="checkbox"/>
7	Copy of co-pending U.S. patent application #13/397,517 document reference: 2012-11-26 Index of Claims	<input type="checkbox"/>
8	Copy of co-pending U.S. patent application #13/397,517 document reference: 2012-11-26 Examiner's search strategy and results	<input type="checkbox"/>
9	Copy of co-pending U.S. patent application #13/397,517 document reference: 2012-11-26 Non Patent Literature - Baiya et al. Provisional Application 61/307196	<input type="checkbox"/>
10	Copy of co-pending U.S. patent application #13/397,517 document reference: 2012-11-26 Search information including classification, databases and other search related notes	<input type="checkbox"/>
11	Copy of co-pending U.S. patent application #13/397,517 document reference: 2012-05-31 Non-Final Rejection	<input type="checkbox"/>
12	Copy of co-pending U.S. patent application #13/397,517 document reference: 2012-05-31 List of references cited by examiner	<input type="checkbox"/>
13	Copy of co-pending U.S. patent application #13/397,517 document reference: 2012-05-31 Index of Claims	<input type="checkbox"/>
14	Copy of co-pending U.S. patent application #13/397,517 document reference: 2012-05-31 Examiner's search strategy and results	<input type="checkbox"/>
15	Copy of co-pending U.S. patent application #13/397,517 document reference: 2012-05-31 Bibliographic Data Sheet	<input type="checkbox"/>

<b>INFORMATION DISCLOSURE STATEMENT BY APPLICANT</b> ( Not for submission under 37 CFR 1.99)	Application Number	13740086
	Filing Date	2013-01-11
	First Named Inventor	William Grecia
	Art Unit	2431
	Examiner Name	Not Applicable
	Attorney Docket Number	

16	Copy of co-pending U.S. patent application #13/397,517 document reference: 2012-05-31 Search information including classification, databases and other search related notes	<input type="checkbox"/>
17	Copy of co-pending U.S. patent application #13/397,517 document reference: 2012-05-31 List of References cited by applicant and considered by examiner	<input type="checkbox"/>

If you wish to add additional non-patent literature document citation information please click the Add button **Add**

**EXAMINER SIGNATURE**

Examiner Signature		Date Considered	
--------------------	--	-----------------	--

\*EXAMINER: Initial if reference considered, whether or not citation is in conformance with MPEP 609. Draw line through a citation if not in conformance and not considered. Include copy of this form with next communication to applicant.

<sup>1</sup> See Kind Codes of USPTO Patent Documents at [www.USPTO.GOV](http://www.USPTO.GOV) or MPEP 901.04. <sup>2</sup> Enter office that issued the document, by the two-letter code (WIPO Standard ST.3). <sup>3</sup> For Japanese patent documents, the indication of the year of the reign of the Emperor must precede the serial number of the patent document. <sup>4</sup> Kind of document by the appropriate symbols as indicated on the document under WIPO Standard ST.16 if possible. <sup>5</sup> Applicant is to place a check mark here if English language translation is attached.

**INFORMATION DISCLOSURE  
STATEMENT BY APPLICANT**  
( Not for submission under 37 CFR 1.99)

Application Number	13740086
Filing Date	2013-01-11
First Named Inventor	William Grecia
Art Unit	2431
Examiner Name	Not Applicable
Attorney Docket Number	

**CERTIFICATION STATEMENT**

Please see 37 CFR 1.97 and 1.98 to make the appropriate selection(s):

That each item of information contained in the information disclosure statement was first cited in any communication from a foreign patent office in a counterpart foreign application not more than three months prior to the filing of the information disclosure statement. See 37 CFR 1.97(e)(1).

**OR**

That no item of information contained in the information disclosure statement was cited in a communication from a foreign patent office in a counterpart foreign application, and, to the knowledge of the person signing the certification after making reasonable inquiry, no item of information contained in the information disclosure statement was known to any individual designated in 37 CFR 1.56(c) more than three months prior to the filing of the information disclosure statement. See 37 CFR 1.97(e)(2).

See attached certification statement.

The fee set forth in 37 CFR 1.17 (p) has been submitted herewith.

A certification statement is not submitted herewith.

**SIGNATURE**

A signature of the applicant or representative is required in accordance with CFR 1.33, 10.18. Please see CFR 1.4(d) for the form of the signature.

Signature	/william grecia/	Date (YYYY-MM-DD)	2013-01-12
Name/Print	William Grecia	Registration Number	70984

This collection of information is required by 37 CFR 1.97 and 1.98. The information is required to obtain or retain a benefit by the public which is to file (and by the USPTO to process) an application. Confidentiality is governed by 35 U.S.C. 122 and 37 CFR 1.14. This collection is estimated to take 1 hour to complete, including gathering, preparing and submitting the completed application form to the USPTO. Time will vary depending upon the individual case. Any comments on the amount of time you require to complete this form and/or suggestions for reducing this burden, should be sent to the Chief Information Officer, U.S. Patent and Trademark Office, U.S. Department of Commerce, P.O. Box 1450, Alexandria, VA 22313-1450. **DO NOT SEND FEES OR COMPLETED FORMS TO THIS ADDRESS. SEND TO: Commissioner for Patents, P.O. Box 1450, Alexandria, VA 22313-1450.**

## Privacy Act Statement

The Privacy Act of 1974 (P.L. 93-579) requires that you be given certain information in connection with your submission of the attached form related to a patent application or patent. Accordingly, pursuant to the requirements of the Act, please be advised that: (1) the general authority for the collection of this information is 35 U.S.C. 2(b)(2); (2) furnishing of the information solicited is voluntary; and (3) the principal purpose for which the information is used by the U.S. Patent and Trademark Office is to process and/or examine your submission related to a patent application or patent. If you do not furnish the requested information, the U.S. Patent and Trademark Office may not be able to process and/or examine your submission, which may result in termination of proceedings or abandonment of the application or expiration of the patent.

The information provided by you in this form will be subject to the following routine uses:

1. The information on this form will be treated confidentially to the extent allowed under the Freedom of Information Act (5 U.S.C. 552) and the Privacy Act (5 U.S.C. 552a). Records from this system of records may be disclosed to the Department of Justice to determine whether the Freedom of Information Act requires disclosure of these records.
2. A record from this system of records may be disclosed, as a routine use, in the course of presenting evidence to a court, magistrate, or administrative tribunal, including disclosures to opposing counsel in the course of settlement negotiations.
3. A record in this system of records may be disclosed, as a routine use, to a Member of Congress submitting a request involving an individual, to whom the record pertains, when the individual has requested assistance from the Member with respect to the subject matter of the record.
4. A record in this system of records may be disclosed, as a routine use, to a contractor of the Agency having need for the information in order to perform a contract. Recipients of information shall be required to comply with the requirements of the Privacy Act of 1974, as amended, pursuant to 5 U.S.C. 552a(m).
5. A record related to an International Application filed under the Patent Cooperation Treaty in this system of records may be disclosed, as a routine use, to the International Bureau of the World Intellectual Property Organization, pursuant to the Patent Cooperation Treaty.
6. A record in this system of records may be disclosed, as a routine use, to another federal agency for purposes of National Security review (35 U.S.C. 181) and for review pursuant to the Atomic Energy Act (42 U.S.C. 218(c)).
7. A record from this system of records may be disclosed, as a routine use, to the Administrator, General Services, or his/her designee, during an inspection of records conducted by GSA as part of that agency's responsibility to recommend improvements in records management practices and programs, under authority of 44 U.S.C. 2904 and 2906. Such disclosure shall be made in accordance with the GSA regulations governing inspection of records for this purpose, and any other relevant (i.e., GSA or Commerce) directive. Such disclosure shall not be used to make determinations about individuals.
8. A record from this system of records may be disclosed, as a routine use, to the public after either publication of the application pursuant to 35 U.S.C. 122(b) or issuance of a patent pursuant to 35 U.S.C. 151. Further, a record may be disclosed, subject to the limitations of 37 CFR 1.14, as a routine use, to the public if the record was filed in an application which became abandoned or in which the proceedings were terminated and which application is referenced by either a published application, an application open to public inspections or an issued patent.
9. A record from this system of records may be disclosed, as a routine use, to a Federal, State, or local law enforcement agency, if the USPTO becomes aware of a violation or potential violation of law or regulation.



Attention To The Commissioner Of Patents:

INFORMATION DISCLOSURE STATEMENTS (IDS) IN ACCORDANCE WITH MPEP 609.02

This application is a continuation of 13/397,517 and subject to the complete IDS, NPL, and Examiner's prosecution history of record within 13/397,517.

IDS that has not yet to be marked as "considered" by the Examiner with his initials within 13/397,517 are included with this submission. Additional IDS information of record and previously considered by the Examiner in 13/391,517 is included with this submission for printing within patent documents.

IDS documents starts on page 2 of this submission.

/William grecia/  
William GreCIA  
Applicant Pro Se

## Electronic Acknowledgement Receipt

<b>EFS ID:</b>	14684944
<b>Application Number:</b>	13740086
<b>International Application Number:</b>	
<b>Confirmation Number:</b>	7081
<b>Title of Invention:</b>	PERSONALIZED DIGITAL MEDIA ACCESS SYSTEM - PDMAS PART II
<b>First Named Inventor/Applicant Name:</b>	William Grecia
<b>Customer Number:</b>	70984
<b>Filer:</b>	William Grecia
<b>Filer Authorized By:</b>	
<b>Attorney Docket Number:</b>	
<b>Receipt Date:</b>	13-JAN-2013
<b>Filing Date:</b>	
<b>Time Stamp:</b>	09:52:58
<b>Application Type:</b>	Utility under 35 USC 111(a)

### Payment information:

Submitted with Payment	no
------------------------	----

### File Listing:

Document Number	Document Description	File Name	File Size(Bytes)/ Message Digest	Multi Part /.zip	Pages (if appl.)
1	Transmittal Letter	idstrans.pdf	156231 <small>3a9e24e7dcaf96b0921b90dbe4b0d5a671390236</small>	no	1

### Warnings:

### Information:

EWS-003928

2	Information Disclosure Statement (IDS) Form (SB08)	IDSrev2.pdf	613315	no	6
			098ca755bba95204cb97f0d8cbf3edf5b864c198		
<b>Warnings:</b>					
<b>Information:</b>					
3	Information Disclosure Statement (IDS) Form (SB08)	IDS-erefs.pdf	613217	no	6
			9d2871afd6b400a4efd2b76e461a5b88624c3c2		
<b>Warnings:</b>					
<b>Information:</b>					
4	Transmittal Letter	idscoverlmac.pdf	212403	no	1
			b55affa685ecfed7a8227f389869b4f76d496244		
<b>Warnings:</b>					
<b>Information:</b>					
5	Non Patent Literature	13397517-Examiner.pdf	10135038	no	174
			aa7ce38066b4d6d26207d5550e35f1933e0f9c57		
<b>Warnings:</b>					
<b>Information:</b>					
<b>Total Files Size (in bytes):</b>			11730204		

**This Acknowledgement Receipt evidences receipt on the noted date by the USPTO of the indicated documents, characterized by the applicant, and including page counts, where applicable. It serves as evidence of receipt similar to a Post Card, as described in MPEP 503.**

**New Applications Under 35 U.S.C. 111**

**If a new application is being filed and the application includes the necessary components for a filing date (see 37 CFR 1.53(b)-(d) and MPEP 506), a Filing Receipt (37 CFR 1.54) will be issued in due course and the date shown on this Acknowledgement Receipt will establish the filing date of the application.**

**National Stage of an International Application under 35 U.S.C. 371**

**If a timely submission to enter the national stage of an international application is compliant with the conditions of 35 U.S.C. 371 and other applicable requirements a Form PCT/DO/EO/903 indicating acceptance of the application as a national stage submission under 35 U.S.C. 371 will be issued in addition to the Filing Receipt, in due course.**

**New International Application Filed with the USPTO as a Receiving Office**

**If a new international application is being filed and the international application includes the necessary components for an international filing date (see PCT Article 11 and MPEP 1810), a Notification of the International Application Number and of the International Filing Date (Form PCT/RO/105) will be issued in due course, subject to prescriptions concerning national security, and the date shown on this Acknowledgement Receipt will establish the international filing date of the application.**

Attention To The Commissioner Of Patents:

INFORMATION DISCLOSURE STATEMENTS (IDS) of Cited References of Parent #13/397,517

This application is a continuation of 13/397,517 and subject to the complete IDS, NPL, and Examiner's prosecution history of record within 13/397,517.

Cited references, Office Actions, considered IDS filings and other submitted documents by the Examiner of 13/397,517 are submitted for record with this child application 13/740,086.

/William grecia/  
William Grecia  
Applicant Pro Se

Under the Paperwork Reduction Act of 1995, no persons are required to respond to a collection of information unless it displays a valid OMB control number.

# UTILITY PATENT APPLICATION TRANSMITTAL

(Only for new nonprovisional applications under 37 CFR 1.53(b))

Attorney Docket No.

First Inventor

Title

Express Mail Label No.

William Grecia

PERSONALIZED DIGITAL MEDIA ACCESS SYSTEM -  
PDMAS PART II

Not Applicable

## APPLICATION ELEMENTS

See MPEP chapter 600 concerning utility patent application contents.

1.  **Fee Transmittal Form** (e.g., PTO/SB/17)
2.  **Applicant claims small entity status.**  
See 37 CFR 1.27.
3.  **Specification** [Total Pages 35]  
Both the claims and abstract must start on a new page  
(For information on the preferred arrangement, see MPEP 608.01(a)) 7
4.  **Drawing(s)** (35 U.S.C. 113) [Total Sheets \_\_\_\_\_]
5. **Oath or Declaration** [Total Sheets 1]  
a.  Newly executed (original or copy)  
b.  A copy from a prior application (37 CFR 1.63(d))  
(for continuation/divisional with Box 18 completed)  
i.  **DELETION OF INVENTOR(S)**  
Signed statement attached deleting inventor(s)  
name in the prior application, see 37 CFR  
1.63(d)(2) and 1.33(b).
6.  **Application Data Sheet.** See 37 CFR 1.76
7.  **CD-ROM or CD-R** in duplicate, large table or  
Computer Program (Appendix)  
 Landscape Table on CD
8. **Nucleotide and/or Amino Acid Sequence Submission**  
(if applicable, items a. - c. are required)  
a.  Computer Readable Form (CRF)  
b.  Specification Sequence Listing on:  
i.  CD-ROM or CD-R (2 copies); or  
ii.  Paper  
c.  Statements verifying identity of above copies

ADDRESS TO:

**Commissioner for Patents**  
**P.O. Box 1450**  
**Alexandria VA 22313-1450**

## ACCOMPANYING APPLICATION PARTS

9.  **Assignment Papers** (cover sheet (PTO-1595) & document(s))  
Name of Assignee \_\_\_\_\_
10.  **37 CFR 3.73(b) Statement**  **Power of Attorney**  
(when there is an assignee)
11.  **English Translation Document** (if applicable)
12.  **Information Disclosure Statement** (PTO/SB/08 or PTO-1449)  
 Copies of foreign patent documents,  
publications, & other information
13.  **Preliminary Amendment**
14.  **Return Receipt Postcard** (MPEP 503)  
(Should be specifically itemized)
15.  **Certified Copy of Priority Document(s)**  
(if foreign priority is claimed)
16.  **Nonpublication Request** under 35 U.S.C. 122(b)(2)(B)(i).  
Applicant must attach form PTO/SB/35 or equivalent.
17.  Other: Track One Priority Request

18. If a CONTINUING APPLICATION, check appropriate box, and supply the requisite information below and in the first sentence of the specification following the title, or in an Application Data Sheet under 37 CFR 1.76:

 Continuation     Divisional     Continuation-in-part (CIP)    of prior application No.: .....

 Prior application information:    Examiner Tran, Tri    Art Unit: 2494

## 19. CORRESPONDENCE ADDRESS

 The address associated with Customer Number: 70984    OR     Correspondence address below

Name

Address

City

State

Zip Code

Country

Telephone

Email

Signature

/william grecia/

Date

01-11-2013

Name  
(Print/Type)

William Grecia

Registration No.  
(Attorney/Agent)

70984

This collection of information is required by 37 CFR 1.53(b). The information is required to obtain or retain a benefit by the public which is to file (and by the USPTO to process) an application. Confidentiality is governed by 35 U.S.C. 122 and 37 CFR 1.11 and 1.14. This collection is estimated to take 12 minutes to complete, including gathering, preparing, and submitting the completed application form to the USPTO. Time will vary depending upon the individual case. Any comments on the amount of time you require to complete this form and/or suggestions for reducing this burden, should be sent to the Chief Information Officer, U.S. Patent and Trademark Office, U.S. Department of Commerce, P.O. Box 1450, Alexandria, VA 22313-1450. DO NOT SEND FEES OR COMPLETED FORMS TO THIS ADDRESS. SEND TO: Commissioner for Patents, P.O. Box 1450, Alexandria, VA 22313-1450.

If you need assistance in completing the form, call 1-800-PTO-9199 and select option 2.

EWS-003931

<p><b>DECLARATION FOR UTILITY OR DESIGN PATENT APPLICATION (37 CFR 1.63)</b></p> <p> <input checked="" type="checkbox"/> Declaration Submitted With Initial Filing                 <span style="margin: 0 20px;">OR</span> <input type="checkbox"/> Declaration Submitted After Initial Filing (surcharge (37 CFR 1.16(f)) required)             </p>	Attorney Docket Number	
	First Named Inventor	William Grecia
	<i>COMPLETE IF KNOWN</i>	
	Application Number	Not Yet Assigned
	Filing Date	Herewith
	Art Unit	Not Yet Assigned
Examiner Name	Not Yet Assigned	

I hereby declare that: (1) Each inventor's residence, mailing address, and citizenship are as stated below next to their name; and (2) I believe the inventor(s) named below to be the original and first inventor(s) of the subject matter which is claimed and for which a patent is sought on the invention titled:

PERSONALIZED DIGITAL MEDIA ACCESS SYSTEM - PDMAS PART II

*(Title of the Invention)*

the application of which was made or was authorized to be made by me and

is attached hereto

OR

was filed on (MM/DD/YYYY) \_\_\_\_\_ as United States Application Number or PCT International Application Number \_\_\_\_\_ and was amended on (MM/DD/YYYY) \_\_\_\_\_ (if applicable).

I hereby state that I have reviewed and understand the contents of the above identified application, including the claims, as amended by any amendment specifically referred to above.

I acknowledge the duty to disclose information which is material to patentability as defined in 37 CFR 1.56, including for continuation-in-part applications, material information which became available between the filing date of the prior application and the national or PCT international filing date of the continuation-in-part application.

**Authorization To Permit Access To Application by Participating Offices**

If checked, the undersigned hereby grants the USPTO authority to provide the European Patent Office (EPO), the Japan Patent Office (JPO), the Korean Intellectual Property Office (KIPO), the World Intellectual Property Office (WIPO), and any other intellectual property offices in which a foreign application claiming priority to the above-identified patent application is filed access to the above-identified patent application. See 37 CFR 1.14(c) and (h). This box should not be checked if the applicant does not wish the EPO, JPO, KIPO, WIPO, or other intellectual property office in which a foreign application claiming priority to the above-identified patent application is filed to have access to the above-identified patent application.

In accordance with 37 CFR 1.14(h)(3), access will be provided to a copy of the above-identified patent application with respect to: 1) the above-identified patent application-as-filed; 2) any foreign application to which the above-identified patent application claims priority under 35 U.S.C. 119(a)-(d) if a copy of the foreign application that satisfies the certified copy requirement of 37 CFR 1.55 has been filed in the above-identified patent application; and 3) any U.S. application-as-filed from which benefit is sought in the above-identified patent application.

In accordance with 37 CFR 1.14(c), access may be provided to information concerning the date of filing the Authorization to Permit Access to Application by Participating Offices.

Under the Paperwork Reduction Act of 1995, no persons are required to respond to a collection of information unless it contains a valid OMB control number.

## DECLARATION — Utility or Design Patent Application

### Claim of Foreign Priority Benefits

I hereby claim foreign priority benefits under 35 U.S.C. 119(a)-(d) or (f), or 365(b) of any foreign application(s) for patent, inventor's or plant breeder's rights certificate(s), or 365(a) of any PCT international application which designated at least one country other than the United States of America, listed below and have also identified below, by checking the box, any foreign application for patent, inventor's or plant breeder's rights certificate(s), or any PCT international application having a filing date before that of the application on which priority is claimed.

Prior Foreign Application Number(s)	Country	Foreign Filing Date (MM/DD/YYYY)	Priority Not Claimed	Certified Copy Attached?	
				YES	NO
			<input type="checkbox"/>	<input type="checkbox"/>	<input type="checkbox"/>
			<input type="checkbox"/>	<input type="checkbox"/>	<input type="checkbox"/>
			<input type="checkbox"/>	<input type="checkbox"/>	<input type="checkbox"/>
			<input type="checkbox"/>	<input type="checkbox"/>	<input type="checkbox"/>

Additional foreign application number(s) are listed on a supplemental priority data sheet PTO/SB/02B attached hereto.

Under the Paperwork Reduction Act of 1995, no persons are required to respond to a collection of information unless it contains a valid OMB control number.

**DECLARATION — Utility or Design Patent Application**

Direct all correspondence to:	<input checked="" type="checkbox"/>	The address associated with Customer Number:	<input type="checkbox"/>	OR	<input type="checkbox"/>	Correspondence address below
		<input type="text" value="70984"/>				
Name						
Address						
City			State		Zip	
Country		Telephone		Email		
<b>WARNING:</b>						
<p>Petitioner/applicant is cautioned to avoid submitting personal information in documents filed in a patent application that may contribute to identity theft. Personal information such as social security numbers, bank account numbers, or credit card numbers (other than a check or credit card authorization form PTO-2038 submitted for payment purposes) is never required by the USPTO to support a petition or an application. If this type of personal information is included in documents submitted to the USPTO, petitioners/applicants should consider redacting such personal information from the documents before submitting them to the USPTO. Petitioner/applicant is advised that the record of a patent application is available to the public after publication of the application (unless a non-publication request in compliance with 37 CFR 1.213(a) is made in the application) or issuance of a patent. Furthermore, the record from an abandoned application may also be available to the public if the application is referenced in a published application or an issued patent (see 37 CFR 1.14). Checks and credit card authorization forms PTO-2038 submitted for payment purposes are not retained in the application file and therefore are not publicly available.</p> <p>I hereby declare that all statements made herein of my own knowledge are true and that all statements made on information and belief are believed to be true; and further that these statements were made with the knowledge that willful false statements and the like so made are punishable by fine or imprisonment, or both, under 18 U.S.C. 1001 and that such willful false statements may jeopardize the validity of the application or any patent issued thereon.</p> <p>I hereby acknowledge that any willful false statement made in this declaration is punishable under 18 U.S.C. 1001 by fine or imprisonment of not more than five (5) years, or both.</p>						
<b>NAME OF SOLE OR FIRST INVENTOR:</b>			<input type="checkbox"/> A petition has been filed for this unsigned inventor			
Given Name (first and middle [if any])			Family Name or Surname			
William			Grecia			
Inventor's Signature				Date		
/william grecia/				01-11-2013		
Residence: City	State	Country	Citizenship			
Brooklyn	NY	USA	USA			
Mailing Address						
2885 Sanford Avenue, Southwest #13208						
City	State	Zip	Country			
Grandville	Michigan	49418	USA			
<input type="checkbox"/> Additional inventors or a legal representative are being named on the _____ supplemental sheet(s) PTO/SB/02A or 02LR attached hereto						



## Privacy Act Statement

**The Privacy Act of 1974 (P.L. 93-579)** requires that you be given certain information in connection with your submission of the attached form related to a patent application or patent. Accordingly, pursuant to the requirements of the Act, please be advised that: (1) the general authority for the collection of this information is 35 U.S.C. 2(b)(2); (2) furnishing of the information solicited is voluntary; and (3) the principal purpose for which the information is used by the U.S. Patent and Trademark Office is to process and/or examine your submission related to a patent application or patent. If you do not furnish the requested information, the U.S. Patent and Trademark Office may not be able to process and/or examine your submission, which may result in termination of proceedings or abandonment of the application or expiration of the patent.

The information provided by you in this form will be subject to the following routine uses:

1. The information on this form will be treated confidentially to the extent allowed under the Freedom of Information Act (5 U.S.C. 552) and the Privacy Act (5 U.S.C. 552a). Records from this system of records may be disclosed to the Department of Justice to determine whether disclosure of these records is required by the Freedom of Information Act.
2. A record from this system of records may be disclosed, as a routine use, in the course of presenting evidence to a court, magistrate, or administrative tribunal, including disclosures to opposing counsel in the course of settlement negotiations.
3. A record in this system of records may be disclosed, as a routine use, to a Member of Congress submitting a request involving an individual, to whom the record pertains, when the individual has requested assistance from the Member with respect to the subject matter of the record.
4. A record in this system of records may be disclosed, as a routine use, to a contractor of the Agency having need for the information in order to perform a contract. Recipients of information shall be required to comply with the requirements of the Privacy Act of 1974, as amended, pursuant to 5 U.S.C. 552a(m).
5. A record related to an International Application filed under the Patent Cooperation Treaty in this system of records may be disclosed, as a routine use, to the International Bureau of the World Intellectual Property Organization, pursuant to the Patent Cooperation Treaty.
6. A record in this system of records may be disclosed, as a routine use, to another federal agency for purposes of National Security review (35 U.S.C. 181) and for review pursuant to the Atomic Energy Act (42 U.S.C. 218(c)).
7. A record from this system of records may be disclosed, as a routine use, to the Administrator, General Services, or his/her designee, during an inspection of records conducted by GSA as part of that agency's responsibility to recommend improvements in records management practices and programs, under authority of 44 U.S.C. 2904 and 2906. Such disclosure shall be made in accordance with the GSA regulations governing inspection of records for this purpose, and any other relevant (i.e., GSA or Commerce) directive. Such disclosure shall not be used to make determinations about individuals.
8. A record from this system of records may be disclosed, as a routine use, to the public after either publication of the application pursuant to 35 U.S.C. 122(b) or issuance of a patent pursuant to 35 U.S.C. 151. Further, a record may be disclosed, subject to the limitations of 37 CFR 1.14, as a routine use, to the public if the record was filed in an application which became abandoned or in which the proceedings were terminated and which application is referenced by either a published application, an application open to public inspection or an issued patent.
9. A record from this system of records may be disclosed, as a routine use, to a Federal, State, or local law enforcement agency, if the USPTO becomes aware of a violation or potential violation of law or regulation.

**CERTIFICATION AND REQUEST FOR PRIORITIZED EXAMINATION  
 UNDER 37 CFR 1.102(e)** (Page 1 of 1)

First Named Inventor:	William Grecia	Nonprovisional Application Number (if known):	Not Assigned
Title of Invention:	PERSONALIZED DIGITAL MEDIA ACCESS SYSTEM - PDMAS PART II		

**APPLICANT HEREBY CERTIFIES THE FOLLOWING AND REQUESTS PRIORITIZED EXAMINATION FOR THE ABOVE-IDENTIFIED APPLICATION.**

1. The processing fee set forth in 37 CFR 1.17(i), the prioritized examination fee set forth in 37 CFR 1.17(c), and if not already paid, the publication fee set forth in 37 CFR 1.18(d) have been filed with the request. The basic filing fee, search fee, examination fee, and any required excess claims and application size fees are filed with the request or have been already been paid.
2. The application contains or is amended to contain no more than four independent claims and no more than thirty total claims, and no multiple dependent claims.

3. The applicable box is checked below:

**I.  Original Application (Track One) - Prioritized Examination under § 1.102(e)(1)**

- i. (a) The application is an original nonprovisional utility application filed under 35 U.S.C. 111(a). This certification and request is being filed with the utility application via EFS-Web.  
 ---OR---  
 (b) The application is an original nonprovisional plant application filed under 35 U.S.C. 111(a). This certification and request is being filed with the plant application in paper.
- ii. An executed oath or declaration under 37 CFR 1.63 is filed with the application.

**II.  Request for Continued Examination - Prioritized Examination under § 1.102(e)(2)**

- i. A request for continued examination has been filed with, or prior to, this form.
- ii. If the application is a utility application, this certification and request is being filed via EFS-Web.
- iii. The application is an original nonprovisional utility application filed under 35 U.S.C. 111(a), or is a national stage entry under 35 U.S.C. 371.
- iv. This certification and request is being filed prior to the mailing of a first Office action responsive to the request for continued examination.
- v. No prior request for continued examination has been granted prioritized examination status under 37 CFR 1.102(e)(2).

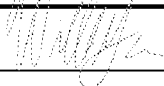
Signature /william grecia/ 	Date 01-11-2013
Name (Print/Typed) William Grecia	Practitioner Registration Number 70984

**Note:** Signatures of all the inventors or assignees of record of the entire interest or their representative(s) are required in accordance with 37 CFR 1.33 and 11.18. Please see 37 CFR 1.4(d) for the form of the signature. If necessary, submit multiple forms for more than one signature, see below\*.

\*Total of 1 forms are submitted.

## Electronic Patent Application Fee Transmittal

<b>Application Number:</b>	13740071
<b>Filing Date:</b>	
<b>Title of Invention:</b>	PERSONALIZED DIGITAL MEDIA ACCESS SYSTEM - PDMAS PART II
<b>First Named Inventor/Applicant Name:</b>	William Grecia
<b>Filer:</b>	William Grecia
<b>Attorney Docket Number:</b>	

Filed as Small Entity

### Track I Prioritized Examination - Nonprovisional Application under 35 USC 111(a) Filing Fees

Description	Fee Code	Quantity	Amount	Sub-Total in USD(\$)
<b>Basic Filing:</b>				
Utility filing Fee (Electronic filing)	4011	1	98	98
Utility Search Fee	2111	1	310	310
Utility Examination Fee	2311	1	125	125
Request for Prioritized Examination	2817	1	2400	2400
<b>Pages:</b>				
<b>Claims:</b>				
Claims in excess of 20	2202	10	31	310
Independent claims in excess of 3	2201	1	125	125

EWS-003937

Description	Fee Code	Quantity	Amount	Sub-Total in USD(\$)
<b>Miscellaneous-Filing:</b>				
Publ. Fee- early, voluntary, or normal	1504	1	300	300
Processing Fee, except for Provis. apps	1808	1	130	130
<b>Petition:</b>				
<b>Patent-Appeals-and-Interference:</b>				
<b>Post-Allowance-and-Post-Issuance:</b>				
<b>Extension-of-Time:</b>				
<b>Miscellaneous:</b>				
<b>Total in USD (\$)</b>				<b>3798</b>

## Electronic Acknowledgement Receipt

<b>EFS ID:</b>	14684037
<b>Application Number:</b>	13740086
<b>International Application Number:</b>	
<b>Confirmation Number:</b>	7081
<b>Title of Invention:</b>	PERSONALIZED DIGITAL MEDIA ACCESS SYSTEM - PDMAS PART II
<b>First Named Inventor/Applicant Name:</b>	William Grecia
<b>Customer Number:</b>	70984
<b>Filer:</b>	William Grecia
<b>Filer Authorized By:</b>	
<b>Attorney Docket Number:</b>	
<b>Receipt Date:</b>	11-JAN-2013
<b>Filing Date:</b>	
<b>Time Stamp:</b>	20:18:38
<b>Application Type:</b>	Utility under 35 USC 111(a)

### Payment information:

Submitted with Payment	yes
Payment Type	Credit Card
Payment was successfully received in RAM	\$3798
RAM confirmation Number	7103
Deposit Account	
Authorized User	

### File Listing:

Document Number	Document Description	File Name	File Size(Bytes)/ Message Digest	Multi Part Zip	Pages (if appl.)
				002039	

1	Drawings-only black and white line drawings	drawings.pdf	128103 a03db35d6454a9c9e1e059a3dd2115d80afdf9a0	no	7
<b>Warnings:</b>					
<b>Information:</b>					
2	Transmittal Letter	idscoverlmac.pdf	212403 b55affa685ecfed7a8227f389869b4f76d496244	no	1
<b>Warnings:</b>					
<b>Information:</b>					
3	Information Disclosure Statement (IDS) Form (SB08)	IDSrev2.pdf	613220 dedf02edc85e27f236eb0ab983cca3f2252db7ef	no	6
<b>Warnings:</b>					
<b>Information:</b>					
4		PDMAS-IIfinalMAC.pdf	194681 8f741adb89a5840f35e4ae007ce603e8d4f58de5	yes	35
	<b>Multipart Description/PDF files in .zip description</b>				
	<b>Document Description</b>		<b>Start</b>	<b>End</b>	
	Specification		1	25	
	Claims		26	34	
	Abstract		35	35	
<b>Warnings:</b>					
<b>Information:</b>					
5	Oath or Declaration filed	sb0001.pdf	129998 ae4a751c7cb8c52196fbb38c4057d9eb42ccfaaa	no	4
<b>Warnings:</b>					
<b>Information:</b>					
6	Transmittal of New Application	sb0005.pdf	209604 08d7870b8ae21ffd65f44e28a330dd01d4880df1	no	1
<b>Warnings:</b>					
<b>Information:</b>					
7	TrackOne Request	sb0424.pdf	112781 9e9465afa2cb2fbbe744408151309e548400fe32	no	1
<b>Warnings:</b>					
<b>Information:</b>					

8	Fee Worksheet (SB06)	fee-info.pdf	43125	no	2
			691cbe44972c534d67f4e604b66c1d8a7d607be2		

**Warnings:**

**Information:**

<b>Total Files Size (in bytes):</b>	1643915
-------------------------------------	---------

**This Acknowledgement Receipt evidences receipt on the noted date by the USPTO of the indicated documents, characterized by the applicant, and including page counts, where applicable. It serves as evidence of receipt similar to a Post Card, as described in MPEP 503.**

**New Applications Under 35 U.S.C. 111**

**If a new application is being filed and the application includes the necessary components for a filing date (see 37 CFR 1.53(b)-(d) and MPEP 506), a Filing Receipt (37 CFR 1.54) will be issued in due course and the date shown on this Acknowledgement Receipt will establish the filing date of the application.**

**National Stage of an International Application under 35 U.S.C. 371**

**If a timely submission to enter the national stage of an international application is compliant with the conditions of 35 U.S.C. 371 and other applicable requirements a Form PCT/DO/EO/903 indicating acceptance of the application as a national stage submission under 35 U.S.C. 371 will be issued in addition to the Filing Receipt, in due course.**

**New International Application Filed with the USPTO as a Receiving Office**

**If a new international application is being filed and the international application includes the necessary components for an international filing date (see PCT Article 11 and MPEP 1810), a Notification of the International Application Number and of the International Filing Date (Form PCT/RO/105) will be issued in due course, subject to prescriptions concerning national security, and the date shown on this Acknowledgement Receipt will establish the international filing date of the application.**

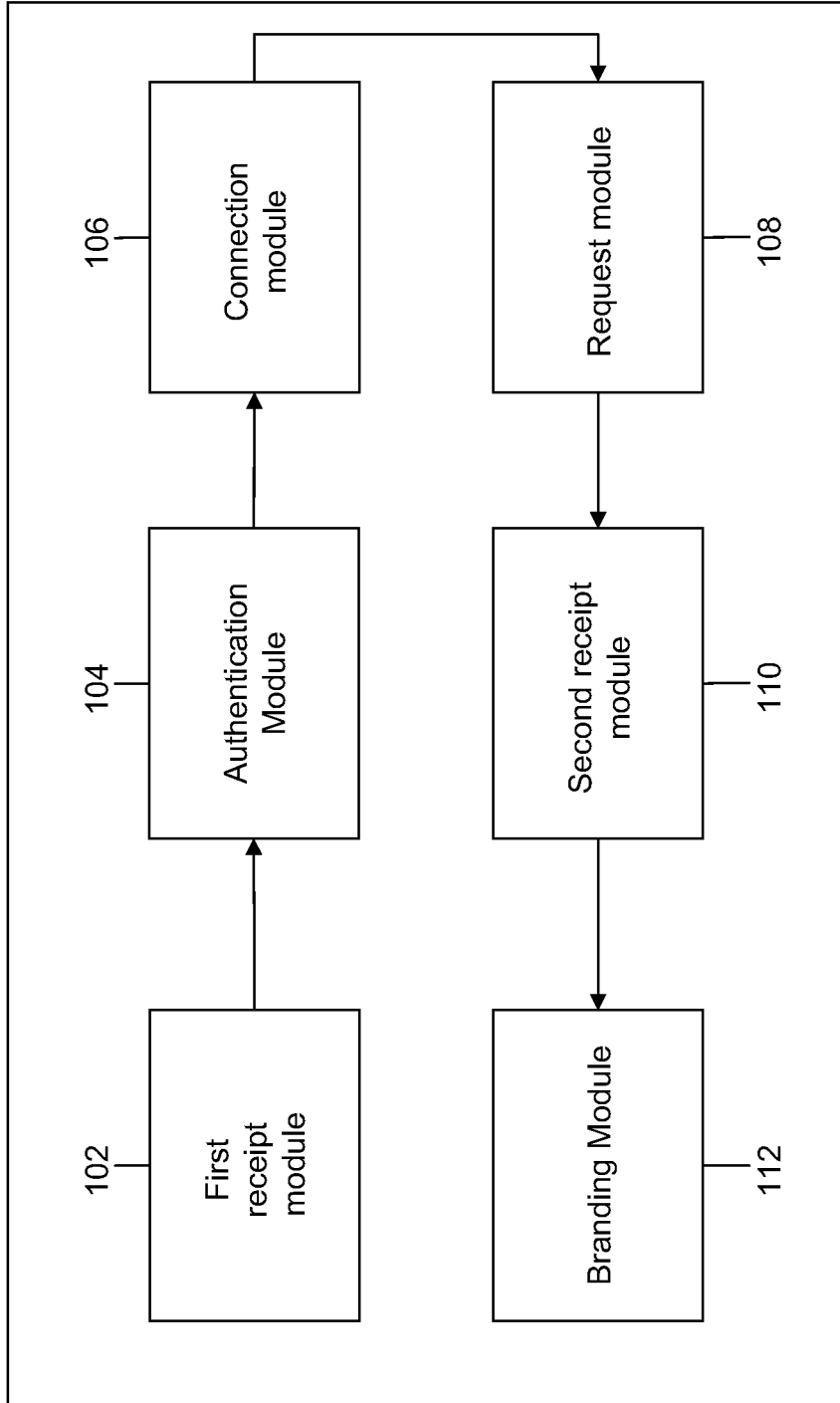

FIG.1



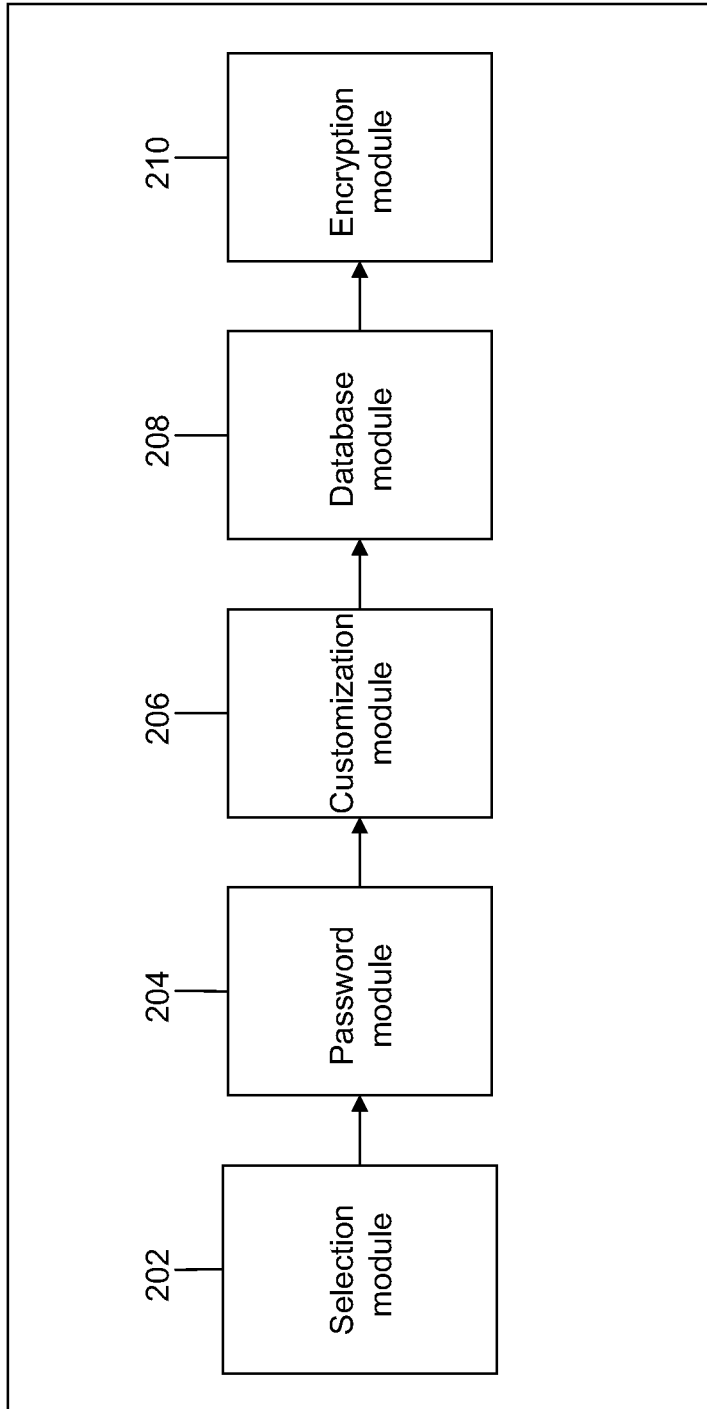

FIG.2

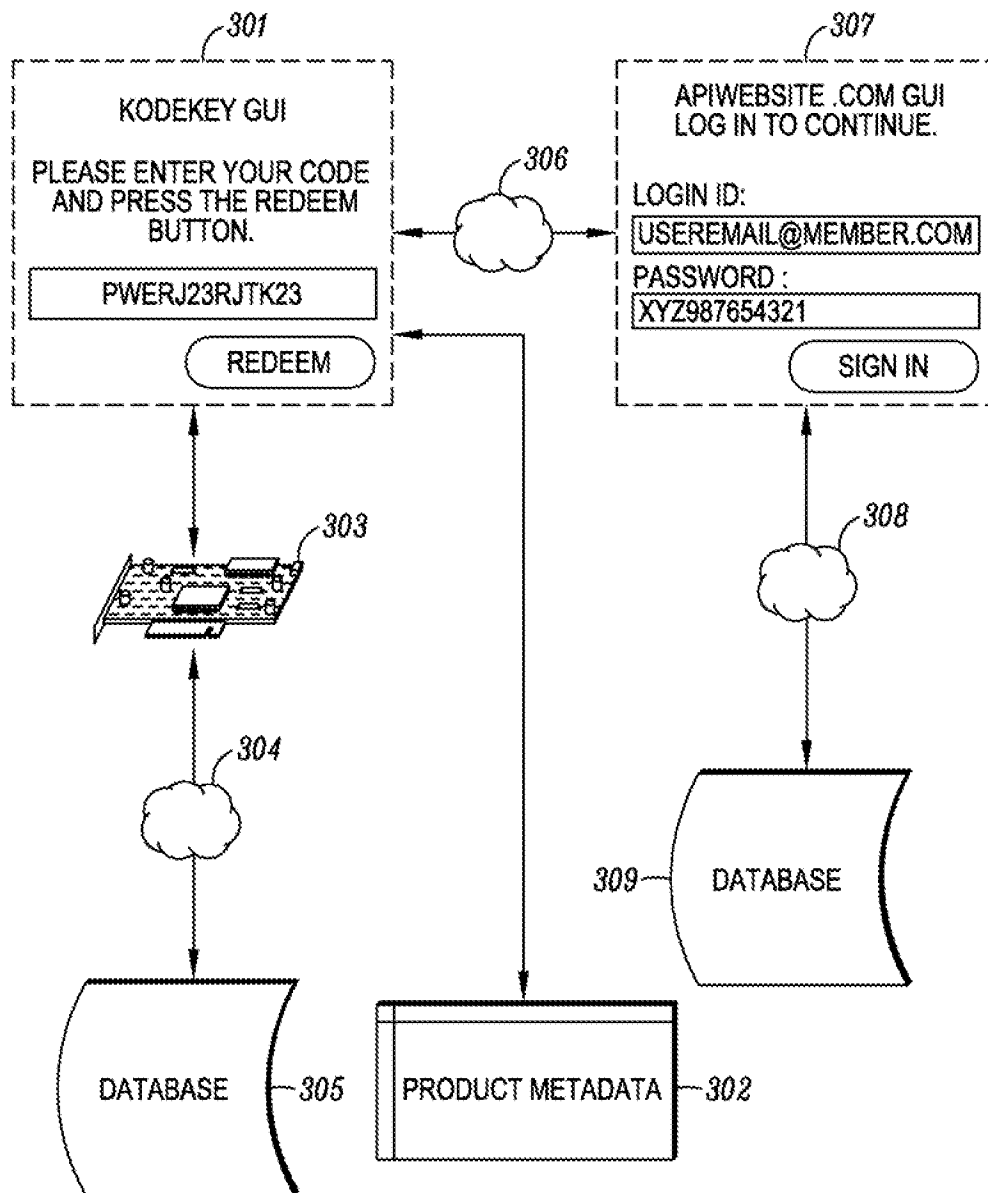

FIG. 3

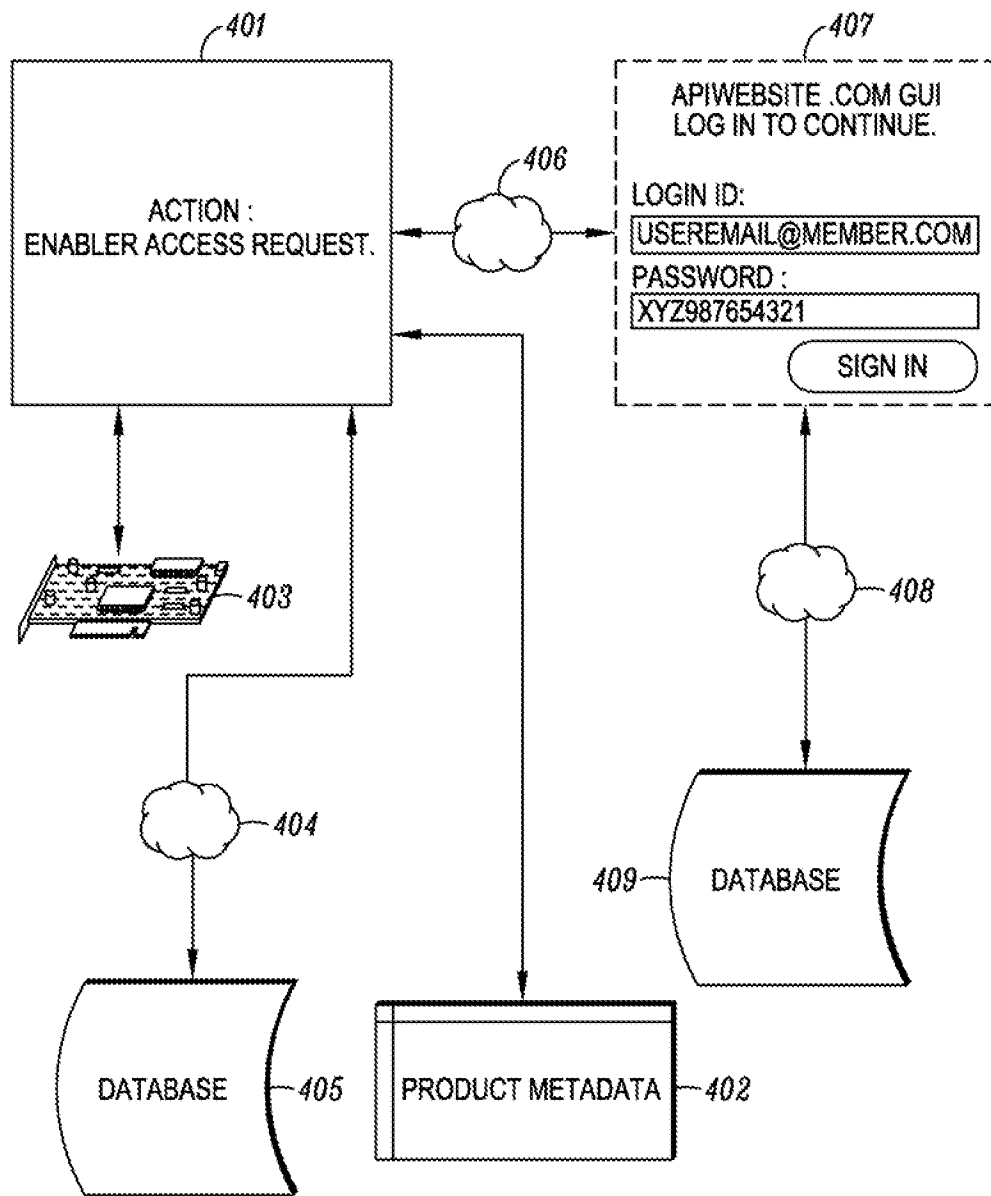

FIG. 4

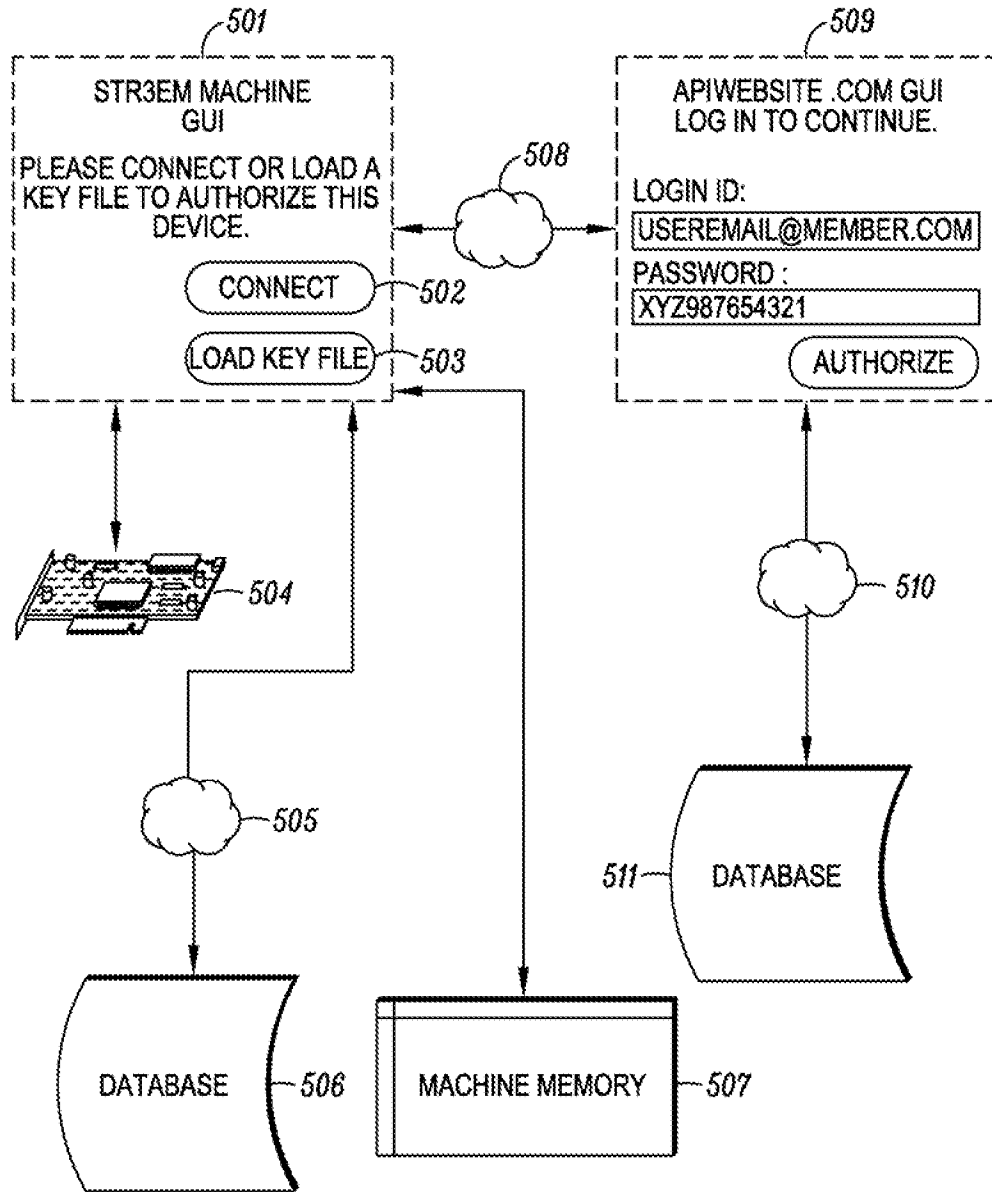

FIG. 5

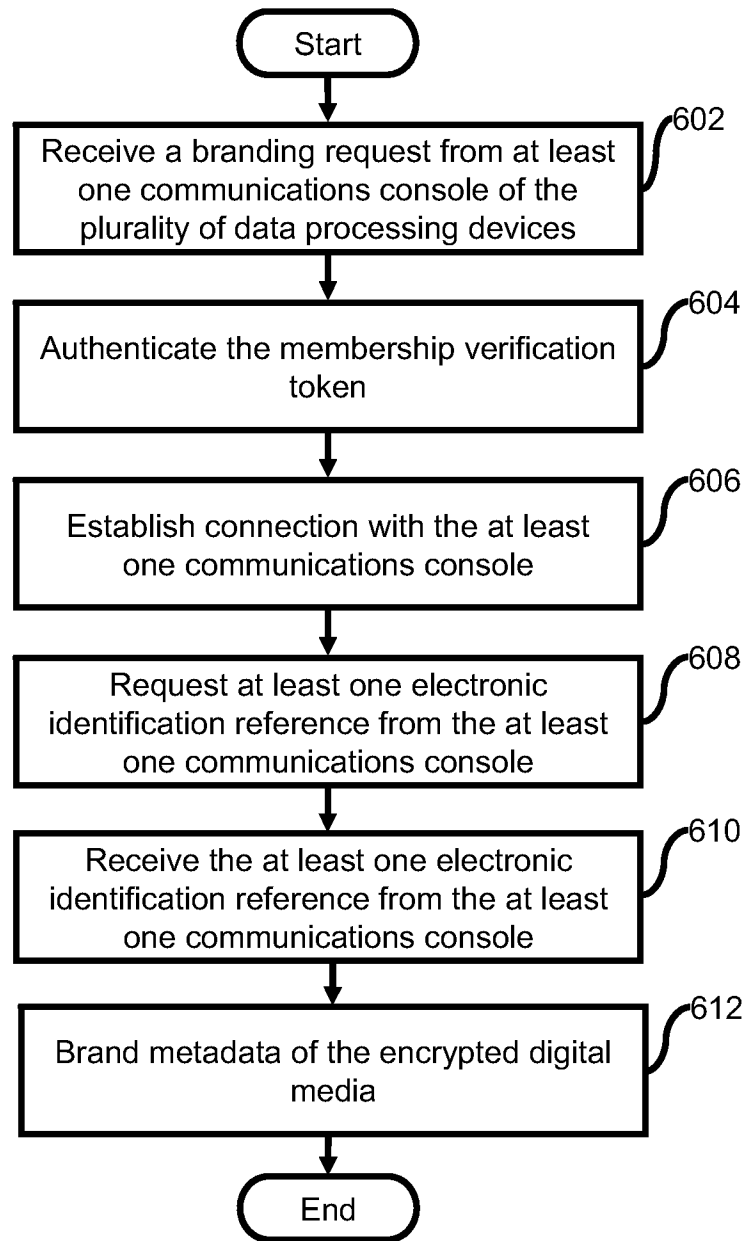

FIG.6

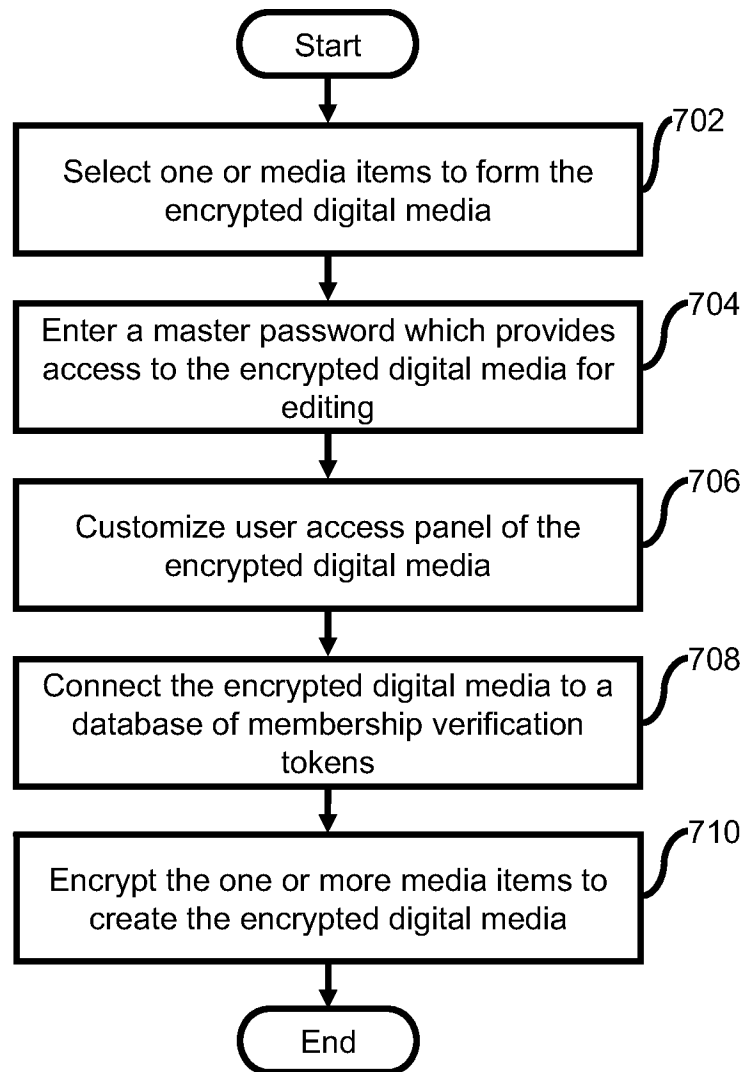

FIG.7

Attention To The Commissioner Of Patents:

INFORMATION DISCLOSURE STATEMENTS (IDS) IN ACCORDANCE WITH MPEP 609.02

This application is a continuation of 13/397,517 and subject to the complete IDS, NPL, and Examiner's prosecution history of record within 13/397,517.

IDS that has not yet to be marked as "considered" by the Examiner with his initials within 13/397,517 are included with this submission. Additional IDS information of record and previously considered by the Examiner in 13/391,517 is included with this submission for printing within patent documents.

IDS documents starts on page 2 of this submission.

/William grecia/  
William Grecia  
Applicant Pro Se

<b>INFORMATION DISCLOSURE STATEMENT BY APPLICANT</b> ( Not for submission under 37 CFR 1.99)	Application Number		
	Filing Date		2013-01-11
	First Named Inventor	William Grecia	
	Art Unit		
	Examiner Name		
	Attorney Docket Number		

U.S.PATENTS						Remove
Examiner Initial*	Cite No	Patent Number	Kind Code <sup>1</sup>	Issue Date	Name of Patentee or Applicant of cited Document	Pages,Columns,Lines where Relevant Passages or Relevant Figures Appear
	1	8250145		2012-08-21	Zuckerberg; Mark	
	2	8280959		2012-10-02	Zuckerberg; Mark	

If you wish to add additional U.S. Patent citation information please click the Add button.

Add

U.S.PATENT APPLICATION PUBLICATIONS						Remove
Examiner Initial*	Cite No	Publication Number	Kind Code <sup>1</sup>	Publication Date	Name of Patentee or Applicant of cited Document	Pages,Columns,Lines where Relevant Passages or Relevant Figures Appear
	1	20110208695		2011-08-25	Anand; Siddharth	
	2	20110265157		2011-10-27	Ryder; Scott	
	3	20110313898		2011-12-22	Singhal; Nitesh	
	4	20110320345		2011-12-29	Taveau; Sebastien	



**INFORMATION DISCLOSURE  
STATEMENT BY APPLICANT**  
( Not for submission under 37 CFR 1.99)

Application Number		
Filing Date		2013-01-11
First Named Inventor	William Grecia	
Art Unit		
Examiner Name		
Attorney Docket Number		

5	20120041829		2012-02-16	Rothschild; Keith Alan	
6	20120130903		2012-03-24	Dorsey; Jack	
7	20120079095		2012-03-29	Evans; Ethan	
8	20120079126		2012-03-29	Evans; Ethan	
9	20120079276		2012-03-29	Evans; Ethan	
10	20120079606		2012-03-29	Evans; Ethan	
11	20120095916		2012-04-19	Dorsey; Jack	
12	20120095906		2012-04-19	Dorsey; Jack	
13	20120095871		2012-04-19	Dorsey; Jack	
14	20120150727		2012-06-14	Nuzzi; Frank Anthony	
15	20120166333		2012-06-28	von Behren; Rob	

**INFORMATION DISCLOSURE  
STATEMENT BY APPLICANT**  
( Not for submission under 37 CFR 1.99)

Application Number		
Filing Date		2013-01-11
First Named Inventor	William Grecia	
Art Unit		
Examiner Name		
Attorney Docket Number		

	16	20120173333		2012-07-05	Berger; Richard	
	17	20120173625		2012-07-05	Berger; Richard	
	18	20120173431		2012-07-05	Ritchie; Ben	
	19	20120191553		2012-07-26	Sathe; Nikhil S	
	20	20110208695		2011-08-25	Anand; Siddharth	
	21	20120254340		2012-10-04	Velummylum; Piragash	
	22	20120255033		2012-10-04	Dwivedi; Sanjeev	
	23	20120290376		2012-11-15	Dryer; Trevor D.	
	24	20120296741		2012-11-22	Dykes; Robert	
	25	20120310828		2012-12-06	Hu; Qilin	
	26	20110313898		2011-12-22	Singhal; Nitesh	

<b>INFORMATION DISCLOSURE STATEMENT BY APPLICANT</b> ( Not for submission under 37 CFR 1.99)	Application Number			
	Filing Date		2013-01-11	
	First Named Inventor	William Grecia		
	Art Unit			
	Examiner Name			
	Attorney Docket Number			

	27	20110320345		2011-12-29	Taveau; Sebastien	
	28	20130007892		2013-01-03	Inooka, Hidehiro	

If you wish to add additional U.S. Published Application citation information please click the Add button. **Add**

**FOREIGN PATENT DOCUMENTS**

Remove

Examiner Initial*	Cite No	Foreign Document Number <sup>3</sup>	Country Code <sup>2</sup> i	Kind Code <sup>4</sup>	Publication Date	Name of Patentee or Applicant of cited Document	Pages, Columns, Lines where Relevant Passages or Relevant Figures Appear	T <sup>5</sup>
	1							<input type="checkbox"/>

If you wish to add additional Foreign Patent Document citation information please click the Add button **Add**

**NON-PATENT LITERATURE DOCUMENTS**

Remove

Examiner Initials*	Cite No	Include name of the author (in CAPITAL LETTERS), title of the article (when appropriate), title of the item (book, magazine, journal, serial, symposium, catalog, etc), date, pages(s), volume-issue number(s), publisher, city and/or country where published.	T <sup>5</sup>
	1		<input type="checkbox"/>

If you wish to add additional non-patent literature document citation information please click the Add button **Add**

**EXAMINER SIGNATURE**

Examiner Signature		Date Considered	
--------------------	--	-----------------	--

\*EXAMINER: Initial if reference considered, whether or not citation is in conformance with MPEP 609. Draw line through a citation if not in conformance and not considered. Include copy of this form with next communication to applicant.

<sup>1</sup> See Kind Codes of USPTO Patent Documents at [www.USPTO.GOV](http://www.USPTO.GOV) or MPEP 901.04. <sup>2</sup> Enter office that issued the document, by the two-letter code (WIPO Standard ST.3). <sup>3</sup> For Japanese patent documents, the indication of the year of the reign of the Emperor must precede the serial number of the patent document. <sup>4</sup> Kind of document by the appropriate symbols as indicated on the document under WIPO Standard ST.16 if possible. <sup>5</sup> Applicant is to place a check mark here if English language translation is attached.

**INFORMATION DISCLOSURE  
STATEMENT BY APPLICANT**  
( Not for submission under 37 CFR 1.99)

Application Number		
Filing Date		2013-01-11
First Named Inventor	William Grecia	
Art Unit		
Examiner Name		
Attorney Docket Number		

**CERTIFICATION STATEMENT**

Please see 37 CFR 1.97 and 1.98 to make the appropriate selection(s):

That each item of information contained in the information disclosure statement was first cited in any communication from a foreign patent office in a counterpart foreign application not more than three months prior to the filing of the information disclosure statement. See 37 CFR 1.97(e)(1).

**OR**

That no item of information contained in the information disclosure statement was cited in a communication from a foreign patent office in a counterpart foreign application, and, to the knowledge of the person signing the certification after making reasonable inquiry, no item of information contained in the information disclosure statement was known to any individual designated in 37 CFR 1.56(c) more than three months prior to the filing of the information disclosure statement. See 37 CFR 1.97(e)(2).

See attached certification statement.

The fee set forth in 37 CFR 1.17 (p) has been submitted herewith.

A certification statement is not submitted herewith.

**SIGNATURE**

A signature of the applicant or representative is required in accordance with CFR 1.33, 10.18. Please see CFR 1.4(d) for the form of the signature.

Signature	/william grecia/	Date (YYYY-MM-DD)	2013-01-11
Name/Print	William Grecia	Registration Number	70984

This collection of information is required by 37 CFR 1.97 and 1.98. The information is required to obtain or retain a benefit by the public which is to file (and by the USPTO to process) an application. Confidentiality is governed by 35 U.S.C. 122 and 37 CFR 1.14. This collection is estimated to take 1 hour to complete, including gathering, preparing and submitting the completed application form to the USPTO. Time will vary depending upon the individual case. Any comments on the amount of time you require to complete this form and/or suggestions for reducing this burden, should be sent to the Chief Information Officer, U.S. Patent and Trademark Office, U.S. Department of Commerce, P.O. Box 1450, Alexandria, VA 22313-1450. **DO NOT SEND FEES OR COMPLETED FORMS TO THIS ADDRESS. SEND TO: Commissioner for Patents, P.O. Box 1450, Alexandria, VA 22313-1450.**

## Privacy Act Statement

The Privacy Act of 1974 (P.L. 93-579) requires that you be given certain information in connection with your submission of the attached form related to a patent application or patent. Accordingly, pursuant to the requirements of the Act, please be advised that: (1) the general authority for the collection of this information is 35 U.S.C. 2(b)(2); (2) furnishing of the information solicited is voluntary; and (3) the principal purpose for which the information is used by the U.S. Patent and Trademark Office is to process and/or examine your submission related to a patent application or patent. If you do not furnish the requested information, the U.S. Patent and Trademark Office may not be able to process and/or examine your submission, which may result in termination of proceedings or abandonment of the application or expiration of the patent.

The information provided by you in this form will be subject to the following routine uses:

1. The information on this form will be treated confidentially to the extent allowed under the Freedom of Information Act (5 U.S.C. 552) and the Privacy Act (5 U.S.C. 552a). Records from this system of records may be disclosed to the Department of Justice to determine whether the Freedom of Information Act requires disclosure of these records.
2. A record from this system of records may be disclosed, as a routine use, in the course of presenting evidence to a court, magistrate, or administrative tribunal, including disclosures to opposing counsel in the course of settlement negotiations.
3. A record in this system of records may be disclosed, as a routine use, to a Member of Congress submitting a request involving an individual, to whom the record pertains, when the individual has requested assistance from the Member with respect to the subject matter of the record.
4. A record in this system of records may be disclosed, as a routine use, to a contractor of the Agency having need for the information in order to perform a contract. Recipients of information shall be required to comply with the requirements of the Privacy Act of 1974, as amended, pursuant to 5 U.S.C. 552a(m).
5. A record related to an International Application filed under the Patent Cooperation Treaty in this system of records may be disclosed, as a routine use, to the International Bureau of the World Intellectual Property Organization, pursuant to the Patent Cooperation Treaty.
6. A record in this system of records may be disclosed, as a routine use, to another federal agency for purposes of National Security review (35 U.S.C. 181) and for review pursuant to the Atomic Energy Act (42 U.S.C. 218(c)).
7. A record from this system of records may be disclosed, as a routine use, to the Administrator, General Services, or his/her designee, during an inspection of records conducted by GSA as part of that agency's responsibility to recommend improvements in records management practices and programs, under authority of 44 U.S.C. 2904 and 2906. Such disclosure shall be made in accordance with the GSA regulations governing inspection of records for this purpose, and any other relevant (i.e., GSA or Commerce) directive. Such disclosure shall not be used to make determinations about individuals.
8. A record from this system of records may be disclosed, as a routine use, to the public after either publication of the application pursuant to 35 U.S.C. 122(b) or issuance of a patent pursuant to 35 U.S.C. 151. Further, a record may be disclosed, subject to the limitations of 37 CFR 1.14, as a routine use, to the public if the record was filed in an application which became abandoned or in which the proceedings were terminated and which application is referenced by either a published application, an application open to public inspections or an issued patent.
9. A record from this system of records may be disclosed, as a routine use, to a Federal, State, or local law enforcement agency, if the USPTO becomes aware of a violation or potential violation of law or regulation.

## **TITLE**

PERSONALIZED DIGITAL MEDIA ACCESS SYSTEM - PDMAS PART II

## **CROSS-REFERENCE TO RELATED APPLICATIONS**

[0001] This application is a continuation of and claims the priority benefit of US patent application serial number 13/397,517 filed February 15, 2012, now pending, which is a continuation of serial number 12/985,351 filed January 6, 2011, now abandoned, which is a continuation of serial number 12/728,218 filed March 21, 2010, now abandoned. Each patent application identified above is incorporated here by reference in its entirety to provide continuity of disclosure.

## **BACKGROUND OF THE INVENTION**

[0002] 1. Field of the Invention

[0003] The present invention relates to the field of digital rights management schemes used by creators of electronic products to protect commercial intellectual property copyrights privy to illegal copying using computerized devices. More specifically, the present invention teaches a more personal system of digital rights management which employs electronic ID, as part of a web service membership, to manage access rights across a plurality of devices.

[0004] 2. Description of the Prior Art

[0005] Digital rights management (DRM) is a generic term for access control technologies used by hardware manufacturers, publishers, copyright holders and individuals to impose limitations on the usage of digital content across devices. DRM refers to any technology that inhibits undesirable or illegal uses of the digital content. The term generally doesn't refer to forms of copy protection that can be circumvented without modifying the file or device, such as serial numbers or key files. It can also refer to restrictions associated with specific instances of digital works or devices.

[0006] Traditional DRM schemes are defined as authentication components added to digital files that have been encrypted from public access. Encryption schemes are not DRM methods but DRM systems are implemented to use an additional layer of authentication in which permission is granted for access to the cipher key required to decrypt files for access. A computer server is established to host decryption keys and to accept authentication keys from Internet connected client computers running client software in which handles the encrypted files. The server can administer different authorization keys back to the client computer that can grant different sets of rules and a time frame granted before the client is required to connect with the server to reauthorize access permissions. In some cases content can terminate access after a set amount of time, or the process can break if the provider of the DRM server ever ceases to offer services.

[0007] In the present scenario, consumer entertainment industries are in the transition of delivering products on physical media such as CD and DVD to Internet delivered systems. The Compact Disc, introduced to the public in 1982, was initially designed as a proprietary system offering strict media to player compatibility. As the popularity of home computers and CD-ROM drives rose, so did the availability of CD ripping applications to make local copies of music to be enjoyed without the use of the disc. After a while, users found ways to share digital versions of music in the form of MP3 files that could be easily shared with family and friends over the Internet. The DVD format introduced in 1997 included a new apparatus for optical discs technology with embedded copy protection schemes also recognized as an early form of DRM. With internet delivered music and video files, DRM schemes has been developed to lock acquired media to specific machines and most times limiting playback rights to a single machine or among a limited number of multiple machines regardless of the model number. This was achieved by writing the machine device ID to the metadata of the media file, then cross referencing with a trusted clearinghouse according to

pre-set rules. DRM systems employed by DVD and CD technologies consisted of scrambling (also known as encryption) disc sectors in a pattern to which hardware developed to unscramble (also known as decryption) the disc sectors are required for playback. DRM systems built into operating systems such as Microsoft Windows Vista block viewing of media when an unsigned software application is running to prevent unauthorized copying of a media asset during playback. DRM used in computer games such as SecuROM and Steam are used to limit the amount of times a user can install a game on a machine. DRM schemes for e-books include embedding credit card information and other personal information inside the metadata area of a delivered file format and restricting the compatibility of the file with a limited number of reader devices and computer applications.

**[0008]** In a typical DRM system, a product is encrypted using Symmetric block ciphers such as DES and AES to provide high levels of security. Ciphers known as asymmetric or public key/private key systems are used to manage access to encrypted products. In asymmetric systems the key used to encrypt a product is not the same as that used to decrypt it. If a product has been encrypted using one key of a pair it cannot be decrypted even by someone else who has that key. Only the matching key of the pair can be used for decryption. After receiving an authorization token from a first-use action are usually triggers to decrypt block ciphers in most DRM systems. User rights and restrictions are established during this first-use action with the corresponding hosting device of a DRM protected product.

**[0009]** Examples of such prior DRM art include Hurtado (U.S. Pat. No. 6,611,812) who described a digital rights management system, where upon request to access digital content, encryption and decryption keys are exchanged and managed via an authenticity clearing house. Other examples include Alve (U.S. Pat. No. 7,568,111) who teaches a DRM and Tuoriniemi (U.S. Pat. No. 20090164776) who described a management scheme to control



access to electronic content by recording use across a plurality of trustworthy devices that has been granted permission to work within the scheme.

**[00010]** Recently, DRM schemes have proven unpopular with consumers and rights organizations that oppose the complications with compatibility across machines manufactured by different companies. Reasons given to DRM opposition range from limited device playback restrictions to the loss of fair-use which defines the freedom to share media products with family members.

**[00011]** Prior art DRM methods rely on content providers to maintain computer servers to receive and send session authorization keys to client computers with an Internet connection. Usually rights are given from the server for an amount of time or amount of access actions before a requirement to reconnect with the server is required for reauthorization. At times, content providers will discontinue servers or even go out of business some years after DRM encrypted content was sold to consumers causing the ability to access files to terminate.

**[00012]** In the light of the foregoing discussion, the current states of DRM measures are not satisfactory because unavoidable issues can arise such as hardware failure or property theft that could lead to a paying customer losing the right to recover purchased products. The current metadata writable DRM measures do not offer a way to provide unlimited interoperability between different machines. Therefore, a solution is needed to give consumers the unlimited interoperability between devices and "fair use" sharing partners for an infinite time frame while protecting commercial digital media from unlicensed distribution to sustain long-term return of investments.

## **SUMMARY OF THE INVENTION**

**[00013]** An object of the present invention is to provide unlimited interoperability of digital media between unlimited machines with management of end-user access to the digital media.

**[00014]** In accordance with an embodiment of the present invention, the invention is a process of an apparatus which in accordance with an embodiment, another apparatus, tangible computer medium, or associated methods (herein referred to as The App) is used to: handle at least one branding action which could include post read and write requests of at least one writable metadata as part of at least one digital media asset to identify and manage requests from at least one excelsior enabler, and can further identify and manage requests from a plurality of connected second enablers; with at least one token and at least one electronic identification reference received from the at least one excelsior enabler utilizing at least one membership. Here, controlled by the at least one excelsior enabler, The App will proceed to receive the at least one token to verify the authenticity of the branding action and further requests; then establish at least one connection with at least one programmable communications console of the at least one membership to request and receive the at least one electronic identification reference; and could request and receive other data information from the at least one membership. The method then involves sending and receiving variable data information from The App to the at least one membership to verify a preexisting the at least one branding action of the at least one writable metadata as part of the at least one digital media asset; or to establish permission or denial to execute the at least one branding action or the post read and write requests of the at least one writable metadata. To do this, controlled by the at least one excelsior enabler. The App may establish at least one connection, which is usually through the Internet, with a programmable communications console, which is usually a combination of an API protocol and graphic user interface (GUI) as part of a web service. In addition, the at least one excelsior enabler provides reestablished

credentials to the programmable communications console as part of the at least one membership, in which The App is facilitating and monitoring, to authenticate the data communications session used to send and receive data requests between the at least one membership and The App.

[00015] In accordance with another embodiment of the present invention, the present invention teaches a method for monitoring access to an encrypted digital media and facilitating unlimited interoperability between a plurality of data processing devices. The method comprises receiving a branding request from at least one communications console of the plurality of data processing devices, the branding request being a read and write request of metadata of the encrypted digital media, the request comprising a membership verification token corresponding to the encrypted digital media. Subsequently, the membership verification token is authenticated, the authentication being performed in connection with a token database. Thereafter, connection with the at least one communications console is established. Afterwards, at least one electronic identification reference is requested from the at least one communications console. Further, the at least one electronic identification reference is received from the at least one communications console. Finally, branding metadata of the encrypted digital media is performed by writing the membership verification token and the electronic identification reference into the metadata.

[00016] The present invention is particularly useful for giving users the freedom to use products outside of the device in which the product was acquired and extend unlimited interoperability with other compatible devices.

#### **BRIEF DESCRIPTION OF THE DRAWINGS**

[00017] For a more complete understanding of the present invention, the needs satisfied thereby, and the objects, features, and advantages thereof, reference now is made to the following description taken in connection with the accompanying drawings.

[00018] FIG. 1 shows a system for monitoring access to an encrypted digital media according to an embodiment of the present invention.

[00019] FIG. 2 shows a system for authoring an encrypted digital media according to an embodiment of the present invention.

[00020] FIG. 3 shows a flow chart giving an overview of the process of digital media personalization according to an embodiment of the present invention.

[00021] FIG. 4 shows a flow chart giving an overview of the process of an access request made by an enabler according to an embodiment of the present invention.

[00022] FIG. 5 shows personalized digital rights management component as part of a compatible machine with writable static memory.

[00023] FIG.6 shows a flowchart for monitoring access to an encrypted digital media according to an embodiment of the present invention

[00024] FIG.7 shows a flowchart showing authoring an encrypted digital media according to an embodiment of the present invention.

[00025] Skilled artisans will appreciate that elements in the figures are illustrated for simplicity and clarity and have not necessarily been drawn to scale. For example, the dimensions of some of the elements in the figures may be exaggerated relative to other elements to help to improve understanding of embodiments of the present invention

#### **DETAILED DESCRIPTION OF THE DRAWINGS**

[00026] Before describing in detail the particular system and method for personalised digital media access system in accordance with an embodiment of the present invention, it should be observed that the present invention resides primarily in combinations of system components related to the device of the present invention.

[00027] Accordingly, the system components have been represented where appropriate by conventional symbols in the drawings, showing only those specific details that are pertinent

to understanding the present invention so as not to obscure the disclosure with details that will be readily apparent to those of ordinary skill in the art having the benefit of the description herein.

[00028] In this document, relational terms such as `first` and `second`, and the like may be used solely to distinguish one entity or action from another entity or action without necessarily requiring or implying any actual such relationship or order between such entities or actions. The terms `comprises`, `comprising`, or any other variation thereof, are intended to cover a non-exclusive inclusion, such that a process, method, article, or apparatus that comprises a list of elements does not include only those elements but may include other elements not expressly listed or inherent to such process, method, article, or apparatus. An element preceded by `comprises . . . a` does not, without more constraints, preclude the existence of additional identical elements in the process, method, article, or apparatus that comprises the element.

The present invention is directed at providing infinite access rights of legally acquired at least one encrypted digital media asset to the content acquirer, explained in this document as the excelsior enabler, and optionally to their recognized friends and family, explained in this document as a plurality of secondary enablers. To explain further, the excelsior enabler and secondary enablers defined comprises human beings or computerized mechanisms programmed to process steps of the invention as would normally be done manually by a human being. Additionally,, an apparatus used alone or in accordance with an embodiment, another apparatus, tangible computer medium, or associated methods with a connection are needed (herein referred to as The App). To deliver the requirements of the invention, communicative and connected elements comprise: verification, authentication, electronic ID metadata branding, additional technical branding, and cross-referencing. The connection handling the communicative actions of the invention will usually be the Internet

and can also be an internal apparatus cooperative. The App can further be defined as a Windows OS, Apple OS, Linux OS, and other operating systems hosting software running on a machine or device with a capable CPU, memory, and data storage. The App can be even further defined as a system on a chip (SOC), embedded silicon, flash memory, programmable circuits, cloud computing and runtimes, and other systems of automated processes.

[00029] The digital media assets used in this system are encrypted usually with an AES cipher and decryption keys are usually stored encoded, no encoded, encrypted, or no encrypted as part of the apparatus or as part of a connection usually an Internet server. As explained earlier, the system we will discuss will work as a front-end to encrypted files as an authorization agent for decrypted access.

[00030] FIG. 1 shows a system **100** for monitoring access to an encrypted digital media according to an embodiment of the present invention. The system **100** includes a first recipient module **102**, an authentication module **104**, a connection module **106**, a request module **108**, a second receipt module **110** and a branding module **112**. The first receipt module **102** receives a branding request from at least one communications console of the plurality of data processing devices. The branding request is a read and write request of metadata of the encrypted digital media and includes a membership verification token corresponding to the encrypted digital media. Examples of the encrypted digital media includes, and are not limited to, one or more of a video file, audio file, container format, document, metadata as part of video game software and other computer based apparatus in which processed data is facilitated.

[00031] Subsequently, the authentication module **104** authenticates the membership verification token. The authentication is performed in connection with a token database. Further, the connection module **106** establishes communication with the at least one communication console.

[00032] According to an embodiment of the present invention, the connection is established through one of internet, intranet, Bluetooth, VPN, Infrared and LAN.

[00033] According to another embodiment of the present invention, the communication console is a combination of an Application Programmable interface (API) protocol and graphic user interface (GUI) as a part of web service. The API is a set of routines, data structures, object classes, and /or protocols provided by libraries and / or operating system services. The API is either one of language dependent or language independent.

[00034] The request module **108** requests at least one electronic identification reference from the at least one communication console. The second receipt module **110** receives the at least one electronic identification reference from the least one communication console. The branding module **112** brands metadata of the encrypted digital media by writing the membership verification token and the electronic identification into the metadata.

[00035] **FIG. 2** shows a system **200** for authoring an encrypted digital media according to an embodiment of the present invention. The figure includes a selection module **202**, a password module **204**, a customization module **206**, a database module **208** and an encryption module **210**. The selection module **202** facilitates selection of one or more media items to form the encrypted digital media. Examples of the one or media items include, and are not limited to, one or more of a video, an audio and a game.

[00036] According to an embodiment of the present invention, the one or more media items are one or more of remote URL links and local media files.

[00037] The password module **204** prompts the user to enter a master password which provides access to the encrypted digital media. Subsequently, the customization module **206** allows the user to customize the user access panel of the encrypted digital media.

[00038] According to an embodiment of the present invention, the customization module **206** facilitates adding one or more of a banner, a logo, an image, an advertisement, a tag line, a

header message and textual information to the user access panel of the encrypted digital media.

[00039] Further, the database module **208** connects the encrypted digital media to a database of membership verification token required for decrypting the encrypted digital media.

[00040] According to an embodiment of the present invention, the membership verification token is a kodekey. The kodekey is a unique serial number assigned to the encrypted digital media.

[00041] The encryption module **210** encrypts the one or more media items to create the encrypted digital media.

[00042] According to an embodiment of the present invention, the system **200** further includes a watermark module. The watermark module watermarks information on the encrypted digital media, wherein the watermark is displayed during playback of the encrypted digital media.

[00043] According to another embodiment of the present invention, the system **200** further includes an access module. The access module allows the user to define access rights. Examples of the access rights include, but are not limited to, purchasing rights, rental rights and membership access rights.

[00044] According to yet another embodiment of the present invention, the system **200** further includes a name module. The name module allows the user to name the encrypted digital media.

[00045] **FIG. 3** shows a flow chart giving an overview of the process of digital media personalization according to an embodiment of the present invention. The process is achieved by way of an enabler using an apparatus or otherwise known as an application in which facilitates digital media files. The apparatus interacts with all communicative parts required



to fulfill the actions of the invention. The figure shows a Kodekey Graphical User Interface (GUI) **301**, a product metadata **302**, a networking card **303**, internet **304**, **306** and **308**, database **305** and **309** and an APIwebsite.com GUI **307**. A user posts a branding request via the Kodekey GUI interface **301**. The Kodekey GUI interface **301** is the GUI for entering token. The Kodekey GUI interface **301** prompts the user to enter the token and press the redeem button present on the Kodekey GUI interface **301**. The product metadata **302** is read / writable metadata associated with the digital media to be acquired. The networking card **303** facilitates querying of optional metadata branding process and referenced. The Kodekey GUI interface is connected to the database **305** via the internet **304** through the networking card **303**. The database **305** is the database used to read/write and store the tokens, also referred to as token database. The user is redirected to the APIwebsite.com GUI **307** through the internet **306**. The APIwebsite.com is the GUI to the membership API in which the electronic ID is collected and sent back to the Kodekey GUI interface **301**. The APIwebsite.com GUI **307** prompts the user to enter a login id and a password to access the digital media which is acquired from the database **309** through the internet **308**. The database **309** is the database connected to the web service membership in which the user's electronic ID is queried from.

[00046] Examples of the encrypted digital files include, and are not limited to, a video file, an audio file, container formats, documents, metadata as part of video game software and other computer based apparatus in which processed data is facilitated.

[00047] FIG. 4 shows a flow chart giving an overview of the process of an access request made by an enabler according to an embodiment of the present invention. Subsequently, the communicative parts to cross-reference information stored in the metadata of the digital media asset are checked which has been previously handled by the process of FIG. 1. The figure shows an enabler access request **401**, a product metadata **402**, a networking card **403**, an internet **404**, **406** and **408**, a database **405** and **409** and an APIwebsite.com GUI **407**, The

enabler access request **401** facilitates the user to make a request for the digital media. The product metadata **402** is read / writable metadata associated with the digital media to be acquired. The networking card **403** facilitates querying of optional metadata branding process and referenced. The database **405** is the database used to read/write and store the tokens. The APIwebsite.com GUI **407** is the GUI in which the electronic ID is collected and sent back to the Kodekey GUI interface **301**. The APIwebsite.com GUI **407** prompts the user to enter a login id and a password to access the digital media from the database **409** through the internet **408**. The database **409** is the database connected to the web service membership in which the user's electronic ID is queried from.

[00048] **FIG. 5** shows personalized digital rights management component as part of a compatible machine with writable static memory. The figure represents an authorization sequence action in which a machine is authorized to accept a personalized digital media file. The figure includes STR3EM Machine GUI **501** including the connect icon **502**, a load key file icon **503**, a networking card **504**, an internet **505**, **508** and **510**, a database **506** and **511**, a machine memory **507** and a APIwebsite.com GUI **509**. The STR3EM Machine GUI **501** prompts the user to connect or load a key file to authorize the device through the connect icon **502** and the load key file icon **503**. The STR3EM Machine GUI **501** is connected to the networking card **504**. The networking card **504** facilitates querying of optional metadata branding process and referenced. Further, the STR3EM machine GUI **501** is connected to the database **506** via the internet **505**. The database **506** is the database used to read/write and store the tokens. Moreover, STR3EM Machine GUI **501** is connected to the machine memory **507**. The machine memory **507** represents the internal memory of the machine or device so authorizations can be saved for access of the digital media. The APIwebsite.com GUI **509** is connected to the STR3EM machine GUI through the internet **508**. Further, APIwebsite.com GUI **509** is connected to the database **511** through the internet **510**. The APIwebsite.com GUI

**509** prompts the user to enter the login id and a password to authorize the access to digital media. The database **511** is the database connected to the web service membership in which the user's electronic ID is queried from.

[**00049**] **FIG.6** shows a flowchart for monitoring access to an encrypted digital media according to an embodiment of the present invention. At step **602**, a branding request is made by a user from at least at least one communications console of the plurality of data processing devices. The branding request is a read and write request of metadata of the encrypted digital media.

[**00050**] According to an embodiment of the present invention, the request includes a membership verification token corresponding to the encrypted digital media.

[**00051**] Subsequently, the membership verification token is authenticated at step **604**. The authentication is performed in connection with a token database. Further, connection with the at least communication console is established at step **606**. Afterwards, at least one electronic identification reference is requested from the at least one communications console at the step **608**. At step **610**, at least one electronic identification reference is received from the at least one communication console. Finally, metadata of the encrypted digital media is branded by writing the membership verification token and the electronic identification reference into the metadata at the step **612**.

[**00052**] **FIG.7** shows a flowchart showing authoring an encrypted digital media according to an embodiment of the present invention. At step **702**, one or more media items are selected by the user to form the encrypted digital media. Subsequently, a master password is entered for providing access to the encrypted digital media for editing at step **704**. Afterwards, the user customizes the user panel of the encrypted digital media at step **706**. Further, the encrypted digital media is connected to a database of membership verification tokens

required for decrypting the encrypted digital media at the step **708**. Finally, the one or more media items are encrypted to create the encrypted digital media at the step **710**.

**[00053]** According to various embodiments of the present invention, the verification is facilitated by at least one token handled by at least one excelsior enabler. Examples of the token include, and are not limited to, a structured or random password, e-mail address associated with an e-commerce payment system used to make an authorization payment, or other redeemable instruments of trade for access rights of digital media. Examples of e-commerce systems are PayPal, Amazon Payments, and other credit card services.

**[00054]** According to an embodiment of the present invention, an identifier for the digital media is stored in a database with another database of a list of associated tokens for cross-reference identification for verification.

**[00055]** According to an embodiment of the present invention, the database of a list of associated tokens includes Instant Payment Notification (IPN) received from successful financial e-commerce transactions that includes the identifier for the digital media; import of CSV password lists, and manually created reference phrases.

**[00056]** For this discussion, the structured or random password example will be used as reference. The structured or random passwords can be devised in encoded schemes to flag the apparatus of permission type such as: 1) Purchases can start a password sequence with "P" following a random number, so further example would be "PSJD42349MFJDF". 2) Rentals can start or end a password sequence with "R" plus (+) the number of days a rental is allowed, for example "R7" included in "R7SJDHFG58473" flagging a seven day rental. 3) Memberships can start or end a password sequence with "M" plus (+) optionally the length of months valid for example "M11DFJGH34KF" would flag an eleven-month membership period.

[00057] According to an embodiment of the present invention, the tokens are stored in a relational database such as MySQL or Oracle.. Cloud storage systems such as Amazon's Web Services Simple Storage Solution, or also known as S3, provides a highly available worldwide replicated infrastructure. In addition to S3, monetization offerings such as DevPay offer developers the opportunity to make money from applications developed to use the services.

[00058] The verification will reference to the S3 and DevPay services for example purposes only as many options such as FTP, SimpleDB, solid state storage and others can be used to host the token hosting needed for the verification element of this invention. The token represents permission from the content provider to grant access rights to the excelsior enabler and thereafter the plurality of secondary enablers. To set up the verification the content provider can manually or automatically generate a single or a plurality of structured or random password in which will represent the token. By using public or private access of S3 as part of an apparatus, the content provider can create empty text files giving each the name of the passwords generated. Because S3 is associated with a highly available worldwide infrastructure, to check this password token can be done my simply constructing a HTTP request from the apparatus and triggering follow up actions based on either a 200 HTTP response, which means OK at which point the next action can happen, or a 400 HTTP response which means ERROR at which point the verification process is voided. An additional token can be used to provide a flag to the apparatus that the verification element has been fulfilled for an initial verification token. Creating an alternate version of the first token by appending a reference to the end, for example, does this: "M11DFJGH34KF\_user@str3em.com\_01\_01\_11". In this example, it is defined that the eleven month authorized membership token was verified by a user@str3em.com on January 1, 2011. By providing a second token, the first token becomes locked to ownership by the

excelsior enabler preventing unauthorized users from reusing the first token without providing the authentication associated with the alternative referenced second token. In the interest of providers of the apparatus delivering this invention, this document will teach a method of a HTTP PUT calculation scheme for automatic royalty billing and administration for the token element used in the invention. Amazon's DevPay allow developers to attach monetary charges to data services of S3 offered as an embedded component of the apparatus. By using the "PUT" requests parameter, tokens generated by the apparatus are monitored, calculated, and charged to clients of the apparatus provider. For example: the default charge measure for DevPay is \$0.05 for every 1000 PUT requests. By changing the amount to \$100 for every 1000 PUT requests, the apparatus provider is paid a \$0.10 royalty for each token created. Content providers using a connected apparatus like DevPay to deliver and manage digital media distribution do not need to have restrictions on the tokens created as with prior art DRM key providers as DevPay is charged on a pay-as-you-need model on a monthly basis. As a novelty to the apparatus provider, if a content provider fails to pay royalties due, the DevPay hosting will automatically deny token access to all related media products in distribution and restore this verification element when royalties are paid in full.

[00059] The authentication element of this invention is at least handled first by the at least one excelsior enabler with a connection to a membership. In the present discussion, the connection is equal to the Internet and the membership is equal to a web service. Further, the web service must be available for two way data exchange to complete the authentication process of this invention. Data exchange with a web service is usually facilitated with a programmable communications console, at most times, will be an Applications Programmable Interface (API). An API is a set of routines, data structures, object classes, and/or protocols provided by libraries and/or operating system services in order to support the building of applications. An API may be language-dependent: that is, available only in a

particular programming language, using the particular syntax and elements of the programming language to make the API convenient to use in this particular context. Alternatively an API may be language-independent: that is, written in a way that means it can be called from several programming languages (typically an assembly/C-level interface). This is a desired feature for a service-style API that is not bound to a particular process or system and is available as a remote procedure call. A more detailed description of API that can be used for an apparatus can be found in the book, "Professional Web APIs with PHP: eBay, Google, Paypal, Amazon, FedEx plus Web Feeds", by Paul Reinheimer, Wrox publishers (2006). A program apparatus, scripts, often calls these APIs or sections of code residing on user computerized devices. For example, a web browser running on a user computer, cell phone, or other device can download a section of JavaScript or other code from a web server, and then use this code to in turn interact with the API of a remote Internet server system as desired. A Graphic User Interface (GUI) can be installed for human interaction or processes can be preprogrammed in a programmable script such as PHP, ASP.Net, Java, Ruby on Rails and others. The authentication element of the invention is usually embedded as a process of the apparatus but could be linked dynamically. In this document, the embedded version using a GUI will be used as reference. The web service equipped with the API is usually a well-known membership themed application in which the users must use an authentic identification. Some example includes Facebook in which as a rule, members are required to use their legal name identities. A reference number or name with the Facebook Platform API represents this information. Other verified web services in which real member names are required such as the LinkedIn API and the PayPal API and even others could be used, but for this discussion, Facebook will be used only as an example of how the authentication element of the invention is utilized. The Facebook API system, as well as others, operates based on an access authentication system called from a connected

apparatus (which is usually an Internet powered desktop or browser based application) with an API Key, an Application Secret Key and could also include an Application ID. For example, the Facebook API Application Keys required to establish a data exchange session with the connected apparatus might look like:

API Key

37a925fc5ee9b4752af981b9a30e9a73gh

Application Secret

f2a2d92ef395cce88eb0261d4b4gsa782

Application ID

51920566446

**[00060]** The collective API keys are usually embedded in the source code of the apparatus, or stored on a remote Internet server, and could be included in the encrypted digital media metadata and inserted on-the-fly into calls made to the API from the connected apparatus. This allows dynamic API connection of the apparatus using keys issued to individual content providers so in the event of a reprimand of a single the individual content provider by the API provider, the collective the individual content providers and the enablers of the connected apparatus are not affected.

**[00061]** Upon an access request of the digital media, the excelsior enabler interacts with the apparatus, usually software or web application, to enter membership credentials in a GUI front-end connected to the API. The membership credentials are usually comprised of a login element comprising a name, phrase, or e-mail address, and a secret password. The credentials can be generated by the enabler or automatically generated by the web service. Once the enabler authenticates their identity with the membership, the apparatus facilitating the data communication can request relevant information to fulfill the process chain of the invention. For example, Facebook API Platform defines members as ID numbers, so if a member's real



name is John Doe, then Facebook API ID (also programmatically known as the FBID) would be 39485678. Once the enabler successfully sign in to the GUI element then the apparatus will query the API for at least one electronic identification reference, in this discussion is the FBID. The FBID is received to the permanent or temporary memory of the apparatus to sustain the branding and cross-referencing requirements of the invention. Additional information can be requested according to membership status or connected "friends" of the enabler. Additional information can be made required for successful authentication and includes: a minimum amount of total friends, a minimum amount of female friends, a minimum amount of male friends, a minimum amount of available pictures, a minimum age limit and other custom rules can be defined by the apparatus. An example of how this would work is a content provider can define a minimum of 32 Facebook friends are required to access an encrypted digital media asset offered for sale or promotion. This is achieved by the apparatus handling a access request in which the enabler has not yet acquired access rights by executing and parsing information returned by the Facebook "Friends.get" API command.

**[00062]** XML return example of the Facebook "Friends.get" API command where a plurality of FBID are returned to the apparatus for parsing additional information as may be required to satisfy successful authentication:

```
<?xml version="1.0" encoding="UTF-8"?>
<friends_get_response xmlns="http://api.facebook.com/1.0/"
xmlns:xsi="http://www.w3.org/2001/XMLSchema-instance"
xsi:schemaLocation="http://api.facebook.com/1.0/ http://api.facebook.com/1.0/facebook.xsd"
list="true">
<uid>222333</uid>
<uid>1240079</uid>
</friends_get_response>
```

[00063] When authenticating a compatible device or machine which may not have access to a connection for the authentication element, a key file or part of the metadata thereof could be made on another connected compatible device or machine and allow the enabler to execute Friends.get API command to collect and store the complete list of a plurality of FBID to the key file or the metadata thereof. The compatible device or machine which may not have access to a connection for the authentication element with an embedded interaction console, usually a user GUI, can request and load the key file or part of the metadata thereof to save the complete list of a plurality of electronic identification references, in this discussion is reference as the FBID, to storage or metadata as part of the compatible device or machine. This step ensures the cross-referencing element requirement of the invention can take place in the event the connection for the authentication element is not present in the compatible device or machine.

[00064] Another example is a content provider can allow shared access to friends of the excelsior enabler after a time period, like for example, 90 days. After the 90 day period, when media access is requested using the authentication element by a plurality of secondary enablers, which are usually friends and family of the excelsior enabler, the FBID of the excelsior enabler is cross-referenced with the FBID of the requesting secondary enabler by way of the apparatus ability to execute the Facebook "Friends.areFriends" API command.

[00065] XML return example of the Facebook "Friends.areFriends" API command where FBID 2223322 and 2222333 are friends and FBID 1240077 and 1240079 are not friends:

```
<?xml version="1.0" encoding="UTF-8"?>
```

```
<friends_areFriends_response
```

```
xmlns=http://api.facebook.com/1.0/
```

```
xmlns:xsi=http://www.w3.org/2001/XMLSchema-instance
```

```
xsi:schemaLocation="http://api.facebook.com/1.0/ http://api.facebook.com/1.0/facebook.xsd"
list="true">
<friend_info>
<uid1>222332</uid1><uid2>222333</uid2>
<are_friends>1</are_friends>
</friend_info>
<friend_info>
<uid1>1240077</uid1><uid2>1240079</uid2>
<are_friends>0</are_friends>
</friend_info>
</friends_areFriends_response>
```

[00066] Such usability can be important to sustain "fair use" rights of consumers of the digital media to emulate usability found with physical media products such as CD and DVD that can be loaned to friends and family after an inception grace period.

[00067] Once the information of the verification and authentication elements is acquired, the apparatus handles the next process of writing the information to the digital media metadata and can include additional information gathered from components of The App. Components of The App can include MAC address from a networking card, CRC checksum of an embedded file or circuit, SOC identifier, embedded serial number, OS version, web browser version, and many other identifiable components as part of The App. For this discussion, the MAC address from a networking card as part of The App will be used as reference of a secondary electronic identification reference. In computer networking, a Media Access Control address (MAC address) is a unique identifier assigned to most network adapters or network interface cards (NICs) by the manufacturer for identification, and used in the Media Access Control protocol sub-layer. If assigned by the manufacturer, a MAC address usually

encodes the manufacturer's registered identification number. It may also be known as an Ethernet Hardware Address (EHA), hardware address, adapter address, or physical address. The novelty of embedding the MAC address along with the FBID of the excelsior enabler is to provide a plurality of electronic identification references in which cross-referencing actions can allow more rapid access to be granted with less interaction from an enabler. For example, to retrieve the FBID from Facebook to cross-reference with the FBID stored in the digital media metadata requires the enabler to possibly physically need to enter their login and password credentials to the GUI connected to the apparatus. It may be possible that web browser cookies allow automatic Facebook login by storing an active session key, but the session key is not guaranteed to be active at the time of an access request. While the enabler may not have an issue executing another authentication command, several remote operations could exist to control authentication and access requests separately from each other. The apparatus can execute a programmable retrieval command, usually a GET command, to locate and retrieve the MAC address from an attached or connected networking card. After the FBID is acquired, the MAC address is also acquired to write the plurality of electronic identifications to the metadata of the at least one encrypted digital media asset by; obtaining the decryption key to decrypt the encrypted digital media asset which is usually stored encoded, no encoded, encrypted, or no encrypted as part of the apparatus or as part of a connected source, usually an Internet server with an encrypted HTTPS protocol. A plurality of MAC addresses can be stored along with the FBID of the excelsior enabler to manage access rights across a plurality of devices. To understand metadata and the uses, metadata is defined simply as to "describe other data". It provides information about certain item's content. For example, an image may include metadata that describes how large the picture is, the color depth, the image resolution, when the image was created, and other data. A text document's metadata may contain information about how long the document is, who the

author is, when the document was written, and a short summary of the document. Web pages often include metadata in the form of Meta tags. Description and keywords Meta tags are commonly used to describe the Web page's content. Most search engines use this data when adding pages to their search index. In the invention, the FBID and MAC addresses are written to the digital media asset metadata to prepare for the instant or delayed cross-referencing element of the invention. The same process of writing the information to the digital media metadata is true with secondary enablers allowing the same benefits of cross-referencing.

[00068] Cross-referencing, the last element of the invention is used to verify access rights of an enabler of a pre or post personalized encrypted digital media asset. Once an enabler executes an action for access request, the apparatus will obtain the decryption key to first seek the MAC address record. If the MAC address is found, then a cross-reference process is executed by comparing the MAC address retrieved from the metadata of the digital media file with the MAC address retrieved from the networking card connected to the apparatus or The App. If the comparison action proves to be true, then access rights are granted to the enabler. If the comparison fails, then the apparatus can either ask the enabler to participate in communication with the authentication element of the invention, or could deny further interactivity with the enabler. In this discussion, the apparatus requires the enabler to participate in communication with the authentication element to provide credentials to establish a cross-reference comparison with the FBID retrieved from the metadata and the FBID retrieved from the Facebook API. If the comparison action proves to be true, then access rights is granted to the excelsior enabler and the current MAC address of the networking card as part of The App is appended to the metadata of the encrypted digital media asset and access rights is granted to the excelsior enabler. If the FBID cross-reference fails, then the apparatus can either ask the potential secondary enabler to participate in communication with the authentication element of the invention, or could deny further

interactivity with the potential secondary enabler. In this discussion, the apparatus requires the potential secondary enabler to participate in communication with the authentication element to provide credentials to establish a cross-reference comparison with the FBID retrieved from the metadata and the FBID retrieved from the Facebook "Friends.areFriends" API command to determine if the potential secondary enabler identity is true or false. The determination is in accordance to any possible access grace periods set by the content provider of the encrypted digital media asset. If the comparison action proves to be true, then access rights is granted to the secondary enabler and the current MAC address of the networking card as part of The App and the FBID retrieved are appended to the established metadata information of the encrypted digital media asset and access rights can be granted to a plurality of secondary enablers; unlimited interoperability between devices and "fair use" sharing partners for an infinite time frame while protecting commercial digital media from unlicensed distribution to sustain long-term return of investments is achieved.

**[00069]** While the present invention has been described in connection with preferred embodiments, it will be understood by those skilled in the art that variations and modifications of the preferred embodiments described above may be made without departing from the scope of the invention. Other embodiments will be apparent to those skilled in the art from a consideration of the specification or from a practice of the invention disclosed herein. It is intended that the specification and the described examples are considered exemplary only, with the true scope of the invention indicated by the following claims.

## [00070] CLAIMS

What is claimed is:

1. A method for monitoring access to an internet connected data source using a cloud system, the cloud system comprising connected modules in operation as one or more of a cloud computing or a cloud storage in connection with devices and enablers, wherein the internet connected data source comprises one or more of a machine, video, audio, container, format, document, credit card information, personal information, textual information, image, advertisement, logo, tag, message, url, video game, software, downloadable program, content provider, service provider, or other computer based apparatus in which processed data is facilitated, the data being one of encrypted or not encrypted, the method facilitating access rights between a plurality of data processing devices, the method comprising:

receiving the internet connected data source access request from at least one communications console of the plurality of data processing devices, the access request being a read or write request of metadata of the internet connected data source, wherein the read or write request of metadata is performed in connection with a combination of at least one device and the cloud system, the request comprising a verification token corresponding to the internet connected data source, wherein the verification token is one or more of a password, e-mail address, payment system, credit card, authorize ready device, rights token, or one or more redeemable instruments of trade;

authenticating the verification token;

establishing a connection with the at least one communications console;

requesting at least one reference from the at least one communications console, wherein the reference is one or more of a web service account identifier, letter, number, rights token, e-mail, password, access time, serial number, address, manufacturer identification,

checksum, file, circuit, operating system version, browser version, credential, cookie, key, or ID;

receiving the at least one reference from the at least one communications console; and  
writing at least one of the verification token or the reference into the metadata.

2. The method according to claim 1, wherein the access request being a request from an excelsior enabler through a data processing device of the plurality of data processing devices;  
or

wherein the access request being a request from one or more secondary enablers in network to the excelsior enabler;

wherein said enablers are validated by a membership web service.

3. The method according to claim 2, wherein the metadata comprises one or more of a software or contents of a web page.

4. The method according to claim 3, wherein the verification token represents verification from a provider of the token to grant access rights to the enabler.

5. The method according to claim 4, wherein the internet connected data source is shared among one or more enablers according to a membership status.

6. The method according to claim 5, wherein the one or more enablers are a network of recognized human beings using machines or recognized automated computerized mechanisms programmed by human beings, the recognition of said enablers being validated by the membership status of the membership web service.

7. The method according to claim 6, wherein the internet connected data source access request is from an enabler using a computer or a phone hosting an operating system running an application.

8. The method of claim 7, wherein said verification token comprises at least one token selected from the group consisting of a purchase, a rental, or a membership permission;



wherein said permission is represented by one or more of a letter, number, combination of letters and numbers, rights token, successful payment reference, phrase, name, membership credentials, image, logo, tag, service name, authorization, list, interface button, downloadable program, or an instrument of trade.

9. A system for monitoring access to an internet connected data source using a worldwide cloud system infrastructure, the worldwide cloud system infrastructure comprising connected modules in operation as computing and storage, the computing and storage comprising a server, a database, a device and an enabler, wherein the internet connected data source comprises one or more of a machine, video, audio, container, format, document, credit card information, personal information, textual information, image, advertisement, logo, tag, message, url, video game, software, downloadable program, content provider, service provider, or other computer based apparatus in which processed data is facilitated, the data being one of encrypted or not encrypted, the system facilitating access rights between a plurality of data processing devices, the system working as a front-end agent for access rights authentication between the plurality of data processing devices, said system further comprising:

a first receipt module, the first receipt module receiving the internet connected data source access request from at least one communications console of the plurality of data processing devices, the access request being a read or write request of metadata of the internet connected data source, wherein the read or write request of metadata is performed in connection with a combination of a device, the server, the database and the cloud system, the metadata further comprises one or more of a software or contents of a web page, the request comprising a verification token corresponding to the internet connected data source, wherein the verification token is one or more of a password, e-mail address, payment system, credit card, authorize ready device, rights token, or one or more redeemable instruments of trade;

an authentication module, the authentication module authenticating the verification token;

a connection module, the connection module establishing a connection with the at least one communications console;

a request module, the request module requesting at least one reference from the at least one communications console, wherein the reference is one or more of a web service account identifier, letter, number, rights token, e-mail, password, access time, serial number, address, manufacturer identification, checksum, file, circuit, operating system version, browser version, credential, cookie, key, or ID;

a secondary receipt module, the secondary receipt module receiving the at least one reference from the at least one communications console; and

a branding module, the branding module writing at least one of the verification token or the reference into the metadata.

10. The system of claim 9, wherein said verification token comprises at least one token selected from the group consisting of a purchase, a rental, or a membership permission;

wherein said permission is represented by one or more of a tag, letter, number, combination of letters and numbers, rights token, successful payment reference, phrase, name, membership credentials, image, logo, service name, authorization, list, interface button, downloadable program, or an instrument of trade.

11. An operating system software program for use with at least one data processing device of a plurality of data processing devices, the data processing device hosting at least one operating system software version of a plurality of operating system software versions, the data processing device comprising a non-transitory usable medium storing the operating system software comprising a program code, the program code being a part of the operating system software or downloaded in sections from a web server, the operating system software

program coupled with an enabler executing a method for monitoring access to a non-public internet connected asset using a cloud system, the cloud system comprising internet connected modules, the method facilitating a data exchange session between a combination of the enabler in operation of the data processing device and the cloud system, the data exchange session establishing an access permission for the internet connected asset, wherein the internet connected asset comprises one or more of a machine, video, audio, container, format, document, credit card information, personal information, textual information, image, advertisement, logo, tag, message, url, video game, software, downloadable program, content provider, service provider, or other computer based apparatus in which processed data is facilitated, the operating system software program coupled with the enabler performing the method steps of:

receiving the internet connected asset access request from at least one communications console of the plurality of data processing devices, the access request being a read or write request of metadata of the internet connected asset, wherein the read or write request of metadata is performed in connection with a combination of the operating system software program and the cloud system, the request comprising a verification token corresponding to the internet connected asset, wherein the verification token is one or more of a password, e-mail address, payment system, credit card, authorize ready device, rights token, key, file, or one or more redeemable instruments of trade;

authenticating the verification token;

establishing a connection with the at least one communications console;

requesting at least one reference from the at least one communications console, wherein the reference is one or more of a web service account identifier, letter, number, rights token, e-mail, password, access time, serial number, address, manufacturer identification,

checksum, file, circuit, operating system version, browser version, credential, cookie, key, or ID;

receiving the at least one reference from the at least one communications console; and  
writing at least one of the verification token or the reference into the metadata.

12. The operating system software program according to claim 11, wherein the access request is a request from the enabler providing a credential to a membership web service through a data processing device of the plurality of data processing devices, the enabler being a human user establishing a permission to the internet connected asset.

13. The operating system software program of claim 12, wherein the verification token comprises at least one of a purchase, a rental, or a membership permission;

wherein said permission is represented by one or more of a tag, letter, number, combination of letters and numbers, successful payment reference, phrase, name, membership credential, image, logo, service name, authorization, list, key, file, interface button, downloadable program, or an instrument of trade.

14. The operating system software program according to claim 13, wherein the verification token represents verification from a provider that a product was acquired.

15. The operating system software program according to claim 13, wherein the internet connected asset is accessed according to a membership status.

16. The operating system software program according to claim 15, wherein the membership status is connected to an application programmable interface.

17. The operating system software program according to claim 15, wherein a remote control operation exist.

18. The operating system software program according to claim 16, wherein the application programmable interface is connected to a graphic user interface.

19. The operating system software program according to claim 17, wherein the internet connected asset is shared with one or more secondary users.

20. The operating system software program according to claim 19, wherein the internet connected asset is shared with the secondary user according to a period of time.

21. A computer product comprising a memory, a CPU, a communications console and a non-transitory computer usable medium, the computer usable medium having an operating system stored therein, the computer product further comprising a customization module, the computer product coupled with an enabler executing a method for monitoring access to a data source, wherein the data source is one of an application, a video, a video game, or a software, the data source being one of a local or an internet connected, wherein the data source is one of encrypted or not encrypted, the computer product coupled with the said enabler performing the method steps of:

receiving the data source access request from the communications console, the access request being a read or write request of metadata of the data source, the metadata of the data source being one or more of a database or storage in connection to the computer product, the request comprising a verification token corresponding to the data source, the verification token is handled by the enabler as a redeemable instrument, wherein the verification token comprises at least one of a purchase, a rental, or a membership permission, the permission being represented by one or more of a tag, a letter, a number, a combination of letters and numbers, a successful payment, a rights token, a phrase, a name, a membership credential, an image, a logo, a service name, an authorization, a list, an interface button, a downloadable program, or the redeemable instrument;

authenticating the verification token;

establishing a connection with the communications console;

requesting at least one reference from the communications console, wherein the reference is one or more of a web service account identifier, letter, number, rights token, e-mail, password, access time, serial number, address, manufacturer identification, checksum, file, circuit, operating system version, browser version, credential, cookie, key, or ID;

receiving the at least one reference from the communications console; and

writing at least one of the verification token or the reference into the said metadata.

22. The computer product according to claim 21, wherein the access request is a request from an excelsior enabler, the excelsior enabler is a human user in operation of the computer product and establishes first access to the data source; or

wherein the access request is a request from a secondary enabler, the secondary enabler is a human user in operation of the computer product and establishes secondary access to the same data source as first established for access by the excelsior enabler.

23. The computer product according to claim 21, wherein the customization module customizes the tag.

24. The computer product according to claim 21, wherein the customization module customizes a user access panel.

25. The computer product according to claim 22, wherein a data source is monitored for access using a worldwide cloud system infrastructure, the worldwide cloud system infrastructure comprising connected modules in operation as computing and storage in connection to the computer product.

26. The computer product according to claim 22, wherein the verification token is connected to a royalty scheme.

27. The computer product according to claim 25, wherein the access is allowed according to a permission facilitated by a web service connected to the worldwide cloud system infrastructure.

28. The computer product according to claim 25, wherein the computer product is a device of a plurality of devices in a network of the enabler.
29. The computer product according to claim 28, wherein the device is a computer or a phone.
30. The computer product according to claim 29, wherein a remote control operation exist.

## **ABSTRACT**

The invention is an apparatus that facilitates access to a data source to accept verification and authentication from an enabler using at least one token and at least one reference. The at least one reference could be a device serial number, a networking MAC address, or a membership ID reference from a web service. Access to the data source is also managed with a plurality of secondary enablers.