

IN THE UNITED STATES PATENT AND TRADEMARK OFFICE

In re Patent of: Poeze, et al.
U.S. Patent No.: 10,292,628 Attorney Docket No.: 50095-0008IP1
Issue Date: May 21, 2019
Appl. Serial No.: 16/261,326
Filing Date: January 29, 2019
Title: MULTI-STREAM DATA COLLECTION SYSTEM FOR NON-
INVASIVE MEASUREMENT OF BLOOD CONSTITUENTS

THIRD DECLARATION OF JACOB ROBERT MUNFORD

1. My name is Jacob Robert Munford. I am over the age of 18, have personal knowledge of the facts set forth herein, and am competent to testify to the same.

2. I earned a Master of Library and Information Science (MLIS) from the University of Wisconsin-Milwaukee in 2009. I have over ten years of experience in the library/information science field. Beginning in 2004, I have served in various positions in the public library sector including Assistant Librarian, Youth Services Librarian and Library Director. I have attached my Curriculum Vitae as Appendix CV.

3. During my career in the library profession, I have been responsible for materials acquisition for multiple libraries. In that position, I have cataloged, purchased and processed incoming library works. That includes purchasing materials directly from vendors, recording publishing data from the material in question, creating detailed material records for library catalogs and physically preparing that material for circulation. In addition to my experience in acquisitions, I was also responsible for analyzing large collections of library materials, tailoring library records for optimal catalog

search performance and creating lending agreements between libraries during my time as a Library Director.

4. I am fully familiar with the catalog record creation process in the library sector. In preparing a material for public availability, a library catalog record describing that material would be created. These records are typically written in Machine Readable Catalog (herein referred to as “MARC”) code and contain information such as a physical description of the material, metadata from the material’s publisher, and date of library acquisition. In particular, the 008 field of the MARC record is reserved for denoting the date of creation of the library record itself. As this typically occurs during the process of preparing materials for public access, it is my experience that an item’s MARC record indicates the date of an item’s public availability.
5. Typically, in creating a MARC record, a librarian would gather various bits of metadata such as book title, publisher and subject headings among others and assign each value to a relevant numerical field. For example, a book’s physical description is tracked in field 300 while title/attribution is tracked in field 245. The 008 field of the MARC record is reserved for denoting the creation of the library record itself. As this is the only date reflecting the inclusion of said materials within the library’s collection, it is my experience

that an item's 008 field accurately indicates the date of an item's public availability.

6. This declaration is being drafted as of September 2021. Public and university libraries in my area have been closed for months due to the COVID-19 pandemic. My state, Pennsylvania, has a travel advisory, which has affected my ability to travel. In my experience, library catalog records are accurate descriptions of a library's collection and my lack of physical access to libraries at this time creates no doubt in my determinations of authenticity or availability of the exhibits noted below.

7. I have reviewed Exhibit APPLE-1044, "Refractive Indices of Human Skin Tissues at Eight Wavelengths and Estimated Dispersion Relations Between 300 and 1600 nm" by Huafeng Ding, Jun Lu, William Wooden, Peter Kragel and Xin-Hua Hu as published in *Physics in Medicine & Biology*, March 2006.

8. Attached hereto as Appendix DING01, is a true and correct copy of scans from *Physics in Medicine & Biology* as held by the Penn State University library. I secured these scans myself from the library's collection. In comparing Exhibit APPLE-1044 to Appendix DING01, it is my

determination that Exhibit APPLE-1044 is a true and correct copy of “Refractive Indices of Human Skin Tissues at Eight Wavelengths and Estimated Dispersion Relations Between 300 and 1600 nm” by Huafeng Ding, Jun Lu, William Wooden, Peter Kragel and Xin-Hua Hu as published in *Physics in Medicine & Biology* in March 2006.

9. Attached hereto as Appendix DING02 is a true and correct copy of the MARC record for *Physics in Medicine & Biology* as held by the Penn State University library. I secured this record myself from the library’s public catalog. The MARC record contained within Appendix DING02 accurately describes the title, author, publisher, and ISSN number of *Physics in Medicine & Biology*. The ‘Availability’ field of this record visible on pages 7-11 indicates this collection includes the March 2006 edition of *Physics in Medicine & Biology* containing “Refractive Indices of Human Skin Tissues at Eight Wavelengths and Estimated Dispersion Relations Between 300 and 1600 nm”.

10. The 008 field of each MARC record in Appendices DING02 indicates the date of record creation. The 008 field of Appendix DING02 indicates the Penn State University library first cataloged this journal as of August 5, 1982 and held the journal in perpetuity until 2012. Considering this

information, it is my determination that *Physics in Medicine & Biology* March 2006 and therefore “Refractive Indices of Human Skin Tissues at Eight Wavelengths and Estimated Dispersion Relations Between 300 and 1600 nm” was made available to the public shortly after its initial release in March 2006.

11. I have reviewed Exhibit APPLE-1052, *Optics* by Eugene Hecht, 2nd Edition.

12. Attached hereto as Appendix HECHT01, is a true and correct copy of scans of select pages from *Optics, 2nd Edition* textbook as held by the University of Pittsburgh library. I secured the textbook and made these scans myself from the library’s collection. For the purposes of this declaration, these scans do not show the entire textbook, but only select pages of the textbook. In comparing Exhibit APPLE-1052 to the textbook from which I obtained the partial scans of Appendix HECHT01, it is my determination that Exhibit APPLE-1052 is a true and correct copy of *Optics, 2nd Edition*.

13. Attached hereto as Appendix HECHT02 is a true and correct copy of the MARC record for *Optics, 2nd Edition* as held by the University of Pittsburgh library. I secured this record myself from the library’s public catalog. The

MARC record contained within Appendix HECHT02 accurately describes the title, author, publisher, and ISBN number of *Optics, 2nd Edition*.

14. The 008 field of each MARC record in Appendices HECHT02 indicates the date of record creation. The 008 field of Appendix HECHT02 indicates the University of Pittsburgh library first acquired this book as of March 3, 1994. Considering this information, it is my determination that *Optics, 2nd Edition* was made available to the public shortly after its initial release in Spring 1994.

15. I have reviewed Exhibit APPLE-1049, *Optics* by Eugene Hecht, 4th Edition.

16. Attached hereto as Appendix HECHT03, is a true and correct copy of scans of select pages from *Optics, 4th Edition* textbook as held by the University of Pittsburgh library. I secured the textbook and made these scans myself from the library's collection. For the purposes of this declaration, these scans do not show the entire textbook, but only select pages of the textbook. In comparing Exhibit APPLE-1049 to the textbook from which I obtained the partial scans of Appendix HECHT03, it is my determination that Exhibit APPLE-1049 is a true and correct copy of *Optics, 4th Edition*.

17. Attached hereto as Appendix HECHT04 is a true and correct copy of the MARC record for *Optics, 4th Edition* as held by the University of Pittsburgh library. I secured this record myself from the library's public catalog. The MARC record contained within Appendix HECHT04 accurately describes the title, author, publisher, and ISBN number of *Optics, 4th Edition*.

18. The 008 field of each MARC record in Appendices HECHT04 indicates the date of record creation. The 008 field of Appendix HECHT04 indicates the University of Pittsburgh library first acquired this book as of November 5, 2001. Considering this information, it is my determination that *Optics, 4th Edition* was made available to the public shortly after its initial release in Fall 2001.

19. I have reviewed Exhibit APPLE-1045, "Analysis of the Dispersion of Optical Plastic Materials" by Stefka Kasarova, Nina Sultanova, Christo Ivanov and Ivan Nikolov as published in *Optical Materials*, July 2007.

20. Attached hereto as Appendix KASAROVA01, is a true and correct digital copy of "Analysis of the Dispersion of Optical Plastic Materials" by Stefka Kasarova, Nina Sultanova, Christo Ivanov and Ivan Nikolov as held by the University of Notre Dame library. I secured this copy myself from the

library's collection. In comparing Exhibit APPLE-1045 to Appendix KASAROVA01, it is my determination that Exhibit APPLE-1045 is a true and correct copy of "Analysis of the Dispersion of Optical Plastic Materials" by Stefka Kasarova, Nina Sultanova, Christo Ivanov and Ivan Nikolov as published in *Optical Materials*, July 2007.

21. Attached hereto as Appendix KASAROVA02 is a true and correct copy of the MARC record for *Optical Materials* as held by the University of Notre Dame library. I secured this record myself from the library's public catalog. The MARC record contained within Appendix KASAROVA02 accurately describes the title, author, publisher, and ISSN number of *Optical Materials*. Selections from the table of contents of this record visible on page 4 indicates this collection includes the July 2007 edition of *Optical Materials* containing "Analysis of the Dispersion of Optical Plastic Materials". In comparing Exhibit APPLE-1045 to Appendix KASAROVA02, it is my determination that Exhibit APPLE-1045 is a true and correct copy of "Analysis of the Dispersion of Optical Plastic Materials" by Stefka Kasarova, Nina Sultanova, Christo Ivanov and Ivan Nikolov as published in *Optical Materials* July 2007.

22. The 008 field of each MARC record in Appendices KASAROVA02 indicates the date of record creation. The 008 field of Appendix KASAROVA02 indicates the University of Notre Dame library first cataloged this journal as of May 11, 1998 and still holds the journal in perpetuity. Considering this information, it is my determination that *Optical Materials* July 2007 and therefore “Analysis of the Dispersion of Optical Plastic Materials” was made available to the public shortly after its initial release in July 2007.

23. I have reviewed Exhibit APPLE-1046, “Noninvasive Pulse Oximetry Utilizing Skin Reflectance Photoplethysmography” by Y. Mendelson and B.D. Ochs as published in *IEEE Transactions on Biomedical Engineering*, October 1988.

24. Attached hereto as Appendix MENDLESON01, is a true and correct digital copy of “Noninvasive Pulse Oximetry Utilizing Skin Reflectance Photoplethysmography” by Y. Mendelson and B.D. Ochs as held by the Carnegie Library of Pittsburgh library. I secured this copy myself from the library’s collection. In comparing Exhibit APPLE-1046 to Appendix MENDLESON01, it is my determination that Exhibit APPLE-1046 is a true and correct copy of “Noninvasive Pulse Oximetry Utilizing Skin

Reflectance Photoplethysmography” by Y. Mendelson and B.D. Ochs as published in *IEEE Transactions on Biomedical Engineering*, October 1988.

25. Attached hereto as Appendix MENDELSON02 is a true and correct copy of the MARC record for *IEEE Transactions on Biomedical Engineering* as held by the Carnegie Library of Pittsburgh. I secured this record myself from the library’s public catalog. The MARC record contained within Appendix MENDELSON02 accurately describes the title, author, publisher, and ISSN number of *IEEE Transactions on Biomedical Engineering*. The ‘Lib. Has’ field of this record visible on page 2 indicates this collection includes the October 1988 edition of *IEEE Transactions on Biomedical Engineering* containing “Noninvasive Pulse Oximetry Utilizing Skin Reflectance Photoplethysmography”. In comparing Exhibit APPLE-1046 to Appendix MENDELSON02, it is my determination that Exhibit APPLE-1046 is a true and correct copy of “Noninvasive Pulse Oximetry Utilizing Skin Reflectance Photoplethysmography” by Y. Mendelson and B.D. Ochs as published in *IEEE Transactions on Biomedical Engineering* October 1988.

26. The 008 field of each MARC record in Appendices MENDELSON02 indicates the date of record creation. The 008 field of Appendix MENDELSON02 indicates the Carnegie Library of Pittsburgh first

cataloged this journal as of November 1, 1975 and held the journal in perpetuity until 2009. Considering this information, it is my determination that *IEEE Transactions on Biomedical Engineering* October 1988 and therefore “Noninvasive Pulse Oximetry Utilizing Skin Reflectance Photoplethysmography” was made available to the public shortly after its initial release in Autumn 1988.

27. Attached hereto as Appendix IEEE03 is a true and correct copy of a declaration made by Mr. Gordon MacPherson, “Director Board Governance & IP Operations of The Institute of Electrical and Electronics Engineers, Incorporated.” Mr. MacPherson’s declaration Appendix IEEE03 states that the “IEEE publishes and makes available technical articles and standards” as part of its “ordinary course of business,” and that these publications are “made available for public download through the IEEE digital library, IEEE Xplore.”

28. Mr. MacPherson’s declaration includes, as Exhibit A, an article referred to as “Y. Mendelson and B.D. Ochs, ‘Noninvasive pulse oximetry utilizing skin reflectance photoplethysmography’, *IEEE Transactions on Biomedical Engineering*, Vol. 35, Issue 10, October 1988,” which was obtained “through IEEE Xplore, where it is maintained in the ordinary course of IEEE’s

business.” Exhibit A also includes a screen capture of the IEEE Xplore portal page for the above-noted article.

29. In comparing the listed fields in Exhibit A of Appendix IEEE03 to Appendix MENDELSON01 and comparing Exhibit A of Appendix IEEE03 to Exhibit APPLE-1046, it is my determination that Exhibit APPLE-1046 is a true and correct copy of the “Noninvasive Pulse Oximetry Utilizing Skin Reflectance Photoplethysmography” article, and that the copy of the 1988 IEEE publication in the Carnegie Library of Pittsburgh includes the article in Exhibit APPLE-1046.

30. I have been retained on behalf of the Petitioner to provide assistance in the above-illustrated matter in establishing the authenticity and public availability of the documents discussed in this declaration. I am being compensated for my services in this matter at the rate of \$100.00 per hour plus reasonable expenses. My statements are objective, and my compensation does not depend on the outcome of this matter.

31. I declare under penalty of perjury that the foregoing is true and correct. I hereby declare that all statements made herein of my own knowledge are true and that all statements made on information and belief are believed to

be true; and further that these statements were made the knowledge that willful false statements and the like so made are punishable by fine or imprisonment, or both, under Section 1001 of Title 18 of the United States Code.

Dated: 9/27/2021

A handwritten signature in black ink, appearing to read 'Jacob R. Munford', written in a cursive style.

Jacob Robert Munford

CV

J. Munford
Curriculum Vitae

Education

University of Wisconsin-Milwaukee - MS, Library & Information Science, 2009
Milwaukee, WI

- Coursework included cataloging, metadata, data analysis, library systems, management strategies and collection development.
- Specialized in library advocacy, cataloging and public administration.

Grand Valley State University - BA, English Language & Literature, 2008
Allendale, MI

- Coursework included linguistics, documentation and literary analysis.
- Minor in political science with a focus in local-level economics and government.

Professional Experience

Researcher / Expert Witness, October 2017 – present
Freelance ● Pittsburgh, Pennsylvania & Grand Rapids, Michigan

- Material authentication and public accessibility determination. Declarations of authenticity and/or public accessibility provided upon research completion. Experienced with appeals and deposition process.
- Research provided on topics of public library operations, material publication history, digital database services and legacy web resources.
- Past clients include Alston & Bird, Arnold & Porter, Baker Botts, Fish & Richardson, Erise IP, Irell & Manella, O'Melveny & Myers, Perkins-Coie, Pillsbury Winthrop Shaw Pittman and Slayden Grubert Beard.

Library Director, February 2013 - March 2015
Dowagiac District Library ● Dowagiac, Michigan

- Executive administrator of the Dowagiac District Library. Located in

Southwest Michigan, this library has a service area of 13,000, an annual operating budget of over \$400,000 and total assets of approximately \$1,300,000.

- Developed careful budgeting guidelines to produce a 15% surplus during the 2013-2014 & 2014-2015 fiscal years while being audited.
- Using this budget surplus, oversaw significant library investments including the purchase of property for a future building site, demolition of existing buildings and building renovation projects on the current facility.
- Led the organization and digitization of the library's archival records.
- Served as the public representative for the library, developing business relationships with local school, museum and tribal government entities.
- Developed an objective-based analysis system for measuring library services - including a full collection analysis of the library's 50,000+ circulating items and their records.

November 2010 - January 2013

Librarian & Branch Manager, Anchorage Public Library ● Anchorage, Alaska

- Headed the 2013 Anchorage Reads community reading campaign including event planning, staging public performances and creating marketing materials for mass distribution.
- Co-led the social media department of the library's marketing team, drafting social media guidelines, creating original content and instituting long-term planning via content calendars.
- Developed business relationships with The Boys & Girls Club, Anchorage School District and the US Army to establish summer reading programs for children.

June 2004 - September 2005, September 2006 - October 2013

Library Assistant, Hart Area Public Library

Hart, MI

- Responsible for verifying imported MARC records and original MARC

cataloging for the local-level collection as well as the Michigan Electronic Library.

- Handled OCLC Worldcat interlibrary loan requests & fulfillment via ongoing communication with lending libraries.

Professional Involvement

Alaska Library Association - Anchorage Chapter

- Treasurer, 2012

Library Of Michigan

- Level VII Certification, 2008
- Level II Certification, 2013

Michigan Library Association Annual Conference 2014

- New Directors Conference Panel Member

Southwest Michigan Library Cooperative

- Represented the Dowagiac District Library, 2013-2015

Professional Development

Library Of Michigan Beginning Workshop, May 2008

Petoskey, MI

- Received training in cataloging, local history, collection management, children's literacy and reference service.

Public Library Association Intensive Library Management Training, October 2011

Nashville, TN

- Attended a five-day workshop focused on strategic planning, staff management, statistical analysis, collections and cataloging theory.

Alaska Library Association Annual Conference 2012 - Fairbanks, February 2012

Fairbanks, AK

- Attended seminars on EBSCO advanced search methods, budgeting, cataloging, database usage and marketing.

Depositions

2019 • Fish & Richardson

IPR Petitions of 865 Patent, Apple v. Qualcomm (IPR2018-001281 / 39521-00421IP & IPR2018-01282 / 39521-00421IP2)

2019 • Erise IP

Implicit, LLC v. Netscout Systems, Inc (Civil Action No. 2:18-cv-53-JRG)

2019 • Perkins-Coie

Adobe Inc. v. RAH Color Technologies LLC (Cases IPR2019-00627, IPR2019-00628, IPR2019-00629 and IPR2019-00646)

2020 • O'Melveny & Myers

Maxell, Ltd. v. Apple Inc. (Case 5:19-cv-00036-RWS)

2021 • Pillsbury Winthrop Shaw Pittman LLP

Intel v. SRC (Case IPR2020-1449)

Limited Case History & Potential Conflicts

Alston & Bird

- Nokia (v. Neptune Subsea, Xtera)

Arnold & Porter

- Ivantis (v. Glaukos)

Erise I.P.

- Apple
 - v. Future Link Systems (IPRs 6317804, 6622108, 6807505, and 7917680)
 - v. INVT
 - v. Navblazer LLC (Case No. IPR2020-01253)

v. Qualcomm (IPR2018-001281, 39521-00421IP, IPR2018-01282, 39521-00421IP2)

v. Quest Nettech Corp, Wynn Technologies (Case No. IPR2019-00XXX, RE. Patent Re38137)

- Fanduel (v CGT)

- Garmin (v. Phillips North America LLC, Case No. 2:19-cv-6301-AB-KS Central District of California)

- Netscout
 - v. Longhorn HD LLC)
 - v. Implicit, LLC (Civil Action No. 2:18-cv-53-JRG)

- Sony Interactive Entertainment LLC
 - v. Bot M8 LLC
 - v. Infernal Technology LLC

- Unified Patents (v GE Video Compression, Civil Action No. 2:19-cv-248)

Fish & Richardson

- Apple
 - v. LBS Innovations

 - v. Masimo (IPR 50095-0012IP1, 50095-0012IP2, 50095-0013IP1, 50095-0013IP2, 50095-0006IP1)

 - v. Neonode

 - v. Qualcomm (IPR2018-001281, 39521-00421IP, IPR2018-01282, 39521-00421IP2)

- Dish Network
 - v. Realtime Adaptive Streaming, Case No 1:17-CV-02097-RBJ)

v. TQ Delta LLC

- Huawei (IPR 76933211)
- Kianxis
- LG Electronics (v. Bell Northern Research LLC, Case No. 3:18-cv-2864-CAB-BLM)
- Metaswitch
- MLC Intellectual Property (v. MicronTech, Case No. 3:14-cv-03657-SI)
- Realtek Semiconductor
- Quectel
- Samsung (v. Bell Northern Research, Civil Action No. 2:19-cv-00286-JRG)
- Texas Instruments

Irell & Manella

- Curium

O'Melveny & Myers

- Apple (v. Maxell, Case 5:19-cv-00036-RWS)

Perkins-Coie

- TCL Industries (v. Koninklijke Philips NV, PTAB Case Nos. IPR2021-00495, IPR2021-00496, and IPR2021-00497)

Pillsbury Winthrop Shaw Pittman

- Intel (v. FG SRC LLC, Case No. 6:20-cv-00315 W.D. Tex)

DING01

ISSN 0031-9155



Physics in Medicine & Biology

Volume 51 Number 6 21 March 2006

Online: www.iop.org/journals/pmb

Published by Institute of Physics Publishing on behalf
of the Institute of Physics and Engineering in Medicine

Institute *of* **Physics** PUBLISHING

Physics in Medicine & Biology

Vol 51, No 6

Pp 1377-1648, N99-138, L13-16

21 March 2006

4635

Physics in Medicine and Biology

Institute of Physics Publishing is a not-for-profit learned society publisher with a reputation for quality and high standards. It has a comprehensive range of products serving the physics and physics-related communities and in particular is an established leader in the world of scientific journals and is at the forefront of electronic publishing. Authors and readers benefit from the rigorous refereeing procedures, prompt publication times and rapid response to research developments, ensuring that the journals are timely, topical and fully validated. Authors of articles in this journal are supplied with 25 free offprints of their articles. There are no page charges.

Journal scope

The application of theoretical and practical physics to medicine, physiology and biology. Papers on physics with no obvious medical or biological applications, or papers which are almost entirely clinical or biological in their approach are not acceptable.

A brief guide for authors

A submission to *Physics in Medicine and Biology* must be the original work of the author(s) and must not be published elsewhere or under consideration for another publication in its submitted or a substantially similar form in any language.

Contributions in the following categories may be submitted. (i) Papers describing original scientific research, techniques or apparatus. Length not more than 8000 words (14 journal pages). (ii) Notes describing a single piece of apparatus, a concise experiment or theoretical treatment, or a novel solution to a commonly encountered problem in medical physics. Length not more than 3500 words (6 journal pages). (iii) Letters to the Editor containing comments on, or criticism of, other published work or comments on general scientific matters. Length not more than 1800 words (3 journal pages).

Details on how to structure an article, including specific information on figures, tables and references, are given in the *Guidelines for authors* available from our Author services website at authors.iop.org.

Special requirements

SI units are mandatory. References must be given in the Harvard (alphabetical) system. Titles of articles and first and last page numbers must be provided.

The journal complies with the position of the International Committee of Medical Journal Editors on 'Conflict of Interest' (*Ann. Int. Med.* 1993, vol 118, 646-7). Authors of all articles are required upon submission to disclose any potential conflict of interest (e.g. employment, consulting fees, industrial research contracts, stock ownership, equity interests, patent-licensing arrangements, honoraria, etc) in their covering letter. This information may be made available to the reviewers, in confidence, during the peer review process. If the article is accepted for publication, information on a potential conflict of interest should be included in an acknowledgments section.

International offices

American office

Institute of Physics Publishing Inc.
The Public Ledger Building, Suite 929
170 South Independence Mall West
Philadelphia, PA 19106, USA
Tel: +1 215 627 9880
Fax: +1 215 627 9879
E-mail: info@ioppublish.com

European office

Institute of Physics Publishing
Dirac House
Temple Back
Bristol BS1 6BE, UK
Tel: +44 (0)117 929 7481
Fax: +44 (0)117 929 4318
E-mail: pmb@iop.org

The journal endorses fully the principles embodied in the Declaration of Helsinki. All investigations involving humans must be conducted in accordance with these principles and in accordance with local statutory requirements. All investigations involving animal experimentation must be conducted in accordance with the 'Guiding Principles for Research Involving Animals and Human Beings' as adopted by the American Physiological Society, and with local statutory requirements.

What to submit

The text of the article can be prepared using Microsoft Word or any common variant of TeX. Figures should be submitted as separate files, preferably in Encapsulated PostScript (EPS) format. Package the text and figure files into a single compressed archive file (e.g. WinZip, PKZip, tar+gzip, etc).

How to submit

You can send your article to us using one of the following methods: Web submission (at authors.iop.org/submit, or from your IOP author homepage—see our Author services website at authors.iop.org for more information), FTP ([ftp.iop.org/incoming/pmb](ftp://ftp.iop.org/incoming/pmb)) or e-mail to pmb@iop.org. Full details on electronic, hard-copy and disk submission are provided in the *Guidelines for authors* at authors.iop.org.

Colour illustrations and multimedia

Colour reproduction of illustrations and multimedia in our Electronic Journals (www.iop.org/journals/pmb) is free of charge. However, for colour reproduction in the printed journal, authors will be asked to pay the additional costs incurred. Multimedia attachments can enhance the electronic version of your article. For further information see the *Guidelines for authors* at authors.iop.org.

Physics in Medicine and Biology

For all concerned with the applications of theoretical and practical physics to medicine, physiology and biology.

Physics in Medicine and Biology is published by Institute of Physics Publishing on behalf of the Institute of Physics and Engineering in Medicine. It is also an official journal of the following medical physics societies: the Canadian Organization of Medical Physicists, the Deutsche Gesellschaft für Medizinische Physik, the Japanese Association of Radiological Physicists, the European Federation of Organisations for Medical Physics and the International Organization for Medical Physics.

Editor-in-Chief

S Webb *Joint Department of Physics, Institute of Cancer Research and Royal Marsden NHS Trust, Sutton, UK*

Editorial Board

P Andreo *IAEA, Vienna, Austria*
F J Beekman *Utrecht University, The Netherlands*
I Buvat *Inserm, Paris, France*
S R Cherry *University of California, Davis, USA*
M Gambaccini *Università di Ferrara, Italy*
P Gowland *Nottingham University, UK*
P J Keall *Medical College of Virginia, Richmond, USA*
M R Neuman *Michigan Technological University, Houghton, USA*
M S Patterson *Hamilton Regional Cancer Centre, Ontario, Canada*
F Verhaegen *McGill University, Montreal, QC, Canada*
Y Yamada *University of Electro-Communications, Tokyo, Japan*

International Advisory Board

M S Alber *Tübingen University, Germany*
C Baldock *Institute of Medical Physics, Sydney, Australia*
A H Beddoe *Queen Elizabeth Hospital, Birmingham, UK*
W E Bolch *University of Florida, Gainesville, USA*
T Bortfeld *Massachusetts General Hospital, Boston, USA*
F M Buffa *Gray Cancer Institute, Oxford, UK*
G T Clement *Harvard Medical School, Cambridge, MA, USA*
Y De Deene *Gent University Hospital, Belgium*
J Deng *Yale University, New Haven, CT, USA*
P J Dimbylow *Health Protection Agency, Chilton, UK*
M Ebert *Newcastle Mater Misericordiae Hospital, Australia*
R H Huesman *Lawrence Berkeley National Laboratory, CA, USA*
M S Huq *University of Pittsburgh Medical Center, PA, USA*
R Jeraj *University of Wisconsin, Madison, USA*
S B Jiang *Massachusetts General Hospital, Boston, USA*
C J Kotre *Newcastle General Hospital, UK*
M O Leach *Institute of Cancer Research and Royal Marsden NHS Trust, Sutton, UK*
A J Lomax *Paul Scherrer Institute, Villigen, Switzerland*
R Marchesini *Istituto Nazionale dei Tumori di Milano, Italy*

A McKenzie *United Bristol Healthcare NHS Trust, Bristol, UK*

P Metcalfe *CMRP, University of Wollongong, Australia*
K-H Ng *University of Malaya, Kuala Lumpur, Malaysia*

F Nüsslin *Tübingen University, Germany*

U Oelfke *DKFZ, Heidelberg, Germany*

M Oldham *Duke University, Durham, NC, USA*

H Rinneberg *Physikalisch-Technische Bundesanstalt, Berlin, Germany*

D W O Rogers *Carleton University, Ottawa, ON, Canada*

J Seuntjens *McGill University, Montreal, QC, Canada*

H J C M Sterenberg *Rotterdam University Hospital, The Netherlands*

J F Sutcliffe *Palmerston North Hospital, New Zealand*

J B Van de Kamer *Academic Medical Center, Amsterdam, The Netherlands*

J Van Dyk *London Regional Cancer Centre, Ontario, Canada*

D Yao *University of Electronic Science & Technology of China, Chengdu, People's Republic of China*

Publisher Jane Roscoe

Publishing Administrator Rebecca Noakes

Production Editor Simon Harris

Marketing Executive Ross Wilmot

Publishing office

Institute of Physics Publishing
Dirac House
Temple Back
Bristol BS1 6BE, UK
Tel: +44 (0)117 929 7481
Fax: +44 (0)117 929 4318
E-mail: pmb@iop.org

Advertisement sales

Marie Moment
Institute of Physics Publishing
Dirac House
Temple Back
Bristol BS1 6BE, UK
Tel: +44 (0)117 930 1125
Fax: +44 (0)117 920 0834
E-mail: marie.moment@iop.org

Physics in Medicine and Biology

Published semi-monthly in hard copy and online by Institute of Physics Publishing, Dirac House, Temple Back, Bristol BS1 6BE, UK.

Institutional subscription information: 2006 volume

For all countries, except the United States, Canada and Central and South America, the subscription rate is £1507.00 per annual volume. Single-issue price £69.00 (except conference issues/supplements—prices available on application). Delivery is by air-speeded mail from the UK.

Orders to:

Journals Subscription Fulfilment
Institute of Physics Publishing
Dirac House, Temple Back
Bristol BS1 6BE, UK

For the USA, Canada and Central and South America, the subscription rate is US\$2910.00 per annual volume. Delivery is by transatlantic airfreight and onward mailing.

Orders to:

American Institute of Physics Subscriber Services
Suite 1NO1, 2 Huntington Quadrangle
Melville, NY 11747-4502, USA

Non-institutional subscription rates are also available.

Back issues

Orders and enquiries for earlier volumes should be sent to the subscription addresses above.

United States Postal Identification Statement

Physics in Medicine and Biology (ISSN: 0031-9155) is published semi-monthly by Institute of Physics Publishing, Dirac House, Temple Back, Bristol BS1 6BE, UK in association with the American Institute of Physics, Suite 1NO1, 2 Huntington Quadrangle, Melville, NY 11747-4502, USA. Periodicals Postage Paid at Huntington Station, NY, and additional mailing offices. POSTMASTER: Send address changes to *Physics in Medicine and Biology*, American Institute of Physics, Suite 1NO1, 2 Huntington Quadrangle, Melville, NY 11747-4502, USA.

Copyright ©2006 by IOP Publishing Ltd and individual contributors. All rights reserved. No part of this publication may be reproduced, stored in a retrieval system or transmitted in any form or by any means, electronic, mechanical, photocopying, recording or otherwise, without the written permission of the publisher, except as stated below. Single photocopies of single articles may be made for private study or research. Illustrations and short extracts from the text of individual contributions may be copied provided that the source is acknowledged, the permission of the authors is obtained and IOP Publishing Ltd is notified. Multiple copying is permitted in accordance with the terms of licences issued by the Copyright Licensing Agency under the terms of its agreement with Universities UK (UUK). Authorization to photocopy items for internal or personal use, or the internal or personal use of specific clients, is granted by IOP Publishing Ltd to libraries and other users registered with the Copyright Clearance Center (CCC) Transactional Reporting Service, provided that the base fee of \$30.00 per copy is paid directly to CCC, 222 Rosewood Drive, Danvers, MA 01923, USA.

Articles in *Physics in Medicine and Biology* are abstracted in: INSPEC® Information Services; Chemical Abstracts; BIOSIS Previews®/Biological Abstracts®; Engineering Index/Ei Compendex®; EMBASE/Excerpta Medica; PASCAL Database; Article@INIST; ISI (SciSearch®, ISI Alerting Services, Science Citation Index®, Current Contents®/Life Sciences); Index Medicus/MEDLINE; VINITI Abstracts Journal; Sociedad Iberoamericana de Información Científica (SIIC).

©™ The paper used in this publication meets the minimum requirements of American National Standard for Information Sciences—Permanence of Paper for Printed Library Materials, ANSI Z39.48-1992.

Printed in the UK by Cambrian Printers Ltd, Aberystwyth SY23 3TN.

Physics in Medicine and Biology

Volume 51 Number 6 21 March 2006

PAPERS

- 1377 **Radiation binary targeted therapy for HER-2 positive breast cancers: assumptions, theoretical assessment and future directions**
D W Mundy, W Harb and T Jevremovic
- 1393 **Investigation of MR image distortion for radiotherapy treatment planning of prostate cancer**
Z Chen, C-M Ma, K Paskalev, J Li, J Yang, T Richardson, L Palacio, X Xu and L Chen
- 1405 **Application of dose compensation in image-guided radiotherapy of prostate cancer**
Q Wu, J Liang and D Yan
- 1421 **Dosimetric validation of the anisotropic analytical algorithm for photon dose calculation: fundamental characterization in water**
A Fogliata, G Nicolini, E Vanetti, A Clivio and L Cozzi
- 1439 **GafChromic® RTQA film for routine quality assurance of high-energy photon beams**
M D R Thomas and A P Warrington
- 1449 **Does elastic tissue intrafraction motion with density changes forbid motion-compensated radiotherapy?**
S Webb
- 1463 **The effect of increase in dielectric values on specific absorption rate (SAR) in eye and head tissues following 900, 1800 and 2450 MHz radio frequency (RF) exposure**
J Keshvari, R Keshvari and S Lang
- 1479 **Refractive indices of human skin tissues at eight wavelengths and estimated dispersion relations between 300 and 1600 nm**
H Ding, J Q Lu, W A Wooden, P J Kragel and X-H Hu
- 1491 **Margins for treatment planning of proton therapy**
S J Thomas
- 1503 **Experimental determination of beam quality factors, k_Q , for two types of Farmer chamber in a 10 MV photon and a 175 MeV proton beam**
J Medin, C K Ross, N V Klassen, H Palmans, E Grusell and J-E Grindborg
- 1523 **Monte Carlo correction factors for a Farmer 0.6 cm³ ion chamber dose measurement in the build-up region of the 6 MV clinical beam**
J Pena, F Sánchez-Doblado, R Capote, J A Terrón and F Gómez
- 1533 **A virtual-accelerator-based verification of a Monte Carlo dose calculation algorithm for electron beam treatment planning in homogeneous phantoms**
E Wieslander and T Knöös
- 1545 **MANTIS: combined x-ray, electron and optical Monte Carlo simulations of indirect radiation imaging systems**
A Badano and J Sempau
- 1563 **Texture analysis of speckle in optical coherence tomography images of tissue phantoms**
K W Gossage, C M Smith, E M Kanter, L P Hariri, A L Stone, J J Rodriguez, S K Williams and J K Barton
- 1577 **Quantitative assessment of computed radiography quality control parameters**
O Rampado, P Isoardi and R Ropolo
- 1595 **A simple method for evaluation of half-value layer variation in CT equipment**
A F Maia and L V E Caldas

Bibliographic codes

CODEN: PHMBA7 51 (6) 1377-1648, N99-N138, L13-L16 (2006)

ISSN: 0031-9155

1603 Fast reconstruction of 3D time-of-flight PET data by axial rebinning and transverse mashing

S Vandenberghe, M E Daube-Witherspoon, R M Lewitt and J S Karp

1623 Organ mapping using paretic spectroscopy

T Blaschke, R Sivaramakrishnan, M Gross and K D Kramer

1633 Ultrasonic characterization of human trabecular bone microstructure

M A Hakulinen, J S Day, J Töyräs, H Weinans and J S Jurvelin

NOTES

N99 Compact soft x-ray transmission microscopy with sub-50 nm spatial resolution

K W Kim, Y Kwon, K-Y Nam, J-H Lim, K-G Kim, K S Chon, B H Kim, D E Kim, J Kim, B N Ahn, H J Shin, S Rah, K-H Kim, J S Chae, D G Gweon, D W Kang, S H Kang, J Y Min, K-S Choi, S E Yoon, E-A Kim, Y Namba and K-H Yoon

N109 Engineered bone from bone marrow stromal cells: a structural study by an advanced x-ray microdiffraction technique

A Cedola, M Mastrogiacomo, M Burghammer, V Komlev, P Giannoni, A Favia, R Cancedda, F Rustichelli and S Lagomarsino

N117 The influence of breathing motion on intensity modulated radiotherapy in the step-and-shoot technique: phantom measurements for irradiation of superficial target volumes

C Thilmann, P Häring, L Thilmann, J Unkelbach, B Rhein, S Nill, P Huber, E Janisch, C Thieke and J Debus

N127 Development and testing of passive tracking markers for different field strengths and tracking speeds

J M Peeters, J-H Seppenwoolde, L W Bartels and C J G Bakker

LETTER TO THE EDITOR

L13 'A finite size pencil beam for IMRT dose optimization'—a simpler analytical function for the finite size pencil beam kernel

H Lin, Y Wu and Y Chen

Refractive indices of human skin tissues at eight wavelengths and estimated dispersion relations between 300 and 1600 nm

Huafeng Ding¹, Jun Q Lu¹, William A Wooden², Peter J Kragel³ and Xin-Hua Hu¹

¹ Department of Physics, East Carolina University, Greenville, NC 27858, USA

² Department of Surgery, Brody School of Medicine, East Carolina University, Greenville, NC 27858, USA

³ Department of Pathology, Brody School of Medicine, East Carolina University, Greenville, NC 27858, USA

E-mail: hux@ecu.edu

Received 7 September 2005, in final form 3 January 2006

Published 1 March 2006

Online at stacks.iop.org/PMB/51/1479

Abstract

The refractive index of human skin tissues is an important parameter in characterizing the optical response of the skin. We extended a previously developed method of coherent reflectance curve measurement to determine the *in vitro* values of the complex refractive indices of epidermal and dermal tissues from fresh human skin samples at eight wavelengths between 325 and 1557 nm. Based on these results, dispersion relations of the real refractive index have been obtained and compared in the same spectral region.

(Some figures in this article are in colour only in the electronic version)

1. Introduction

Understanding the response of the skin to optical radiation is essential to the dermatological applications of photomedicine. Among various skin optical parameters, refractive index is an important one. At the microscopic scales ranging from 1 to 10 μm , refractive index variation causes light scattering which can be understood by direct solution of the Maxwell equations within the framework of classical electrodynamics for simple shaped particles (Bohren and Huffman 1983, Ma *et al* 2003a) and for biological cells (Lu *et al* 2005). For highly turbid tissues of human skin with sizes of 1 mm or larger, modelling of tissue optics based on the electrodynamic theory is very difficult, and the real refractive index and scattering parameters are often treated as independent parameters within the frameworks of effective medium theory and radiative transfer theory, respectively. For example, in the widely used method of Monte Carlo simulation of light distribution in biological tissues, photon interaction with an interface

between tissue regions of different refractive indices is described according to the Fresnel equations which require the index as the key parameter (van Gemert *et al* 1989, Wang *et al* 1995, Lu *et al* 2000). Furthermore, accurate modelling of measured light signals near a skin surface requires the refractive indices of skin tissues to account for the redistribution of light due to the index mismatch at the surface (Lu *et al* 2000, Meglinsky and Matcher 2001, Bartlett and Jiang 2001, Ma *et al* 2003b, 2005).

Determination of the refractive indices of the human skin tissues, however, presents challenges because of their highly turbid natures. In transparent or absorbing media such as the aqueous solutions with molecular solutes, propagation of light is dominated by its coherent component. The reflection and refraction of a light beam, as it passes through an interface between two media of different refractive indices, are described with the Fresnel equations on the basis of an effective medium theory. In contrast, light propagation in a turbid medium produces a scattering component that becomes increasingly dominant as the light penetrates into the medium. This feature of interaction often precludes the use of refraction method to determine the refractive index of biological tissue samples where uniform and thin samples are very difficult to obtain. Recently, we developed an automated reflectometer system for determining the refractive index of a turbid sample by measurement of its coherent reflectance R versus the incident angle θ without the need to section skin tissues (Ding *et al* 2005). Here we report complex refractive indices of fresh human skin tissues determined by nonlinear regression of $R(\theta)$ with the Fresnel equations. The complex refractive index has been obtained at eight wavelengths between 325 and 1557 nm for both the epidermis and dermis tissues. With these data we investigated various dispersion schemes for interpolation of the index data at other wavelengths in this spectral region.

2. Methods

Fresh skin tissue patches were obtained from the patients undergoing abdominoplasty procedures at the plastic surgery clinic of the Brody School of Medicine, East Carolina University (ECU). A study protocol approved by the Institutional Review Board of ECU was strictly followed and a consent form was signed by each participating patient before the surgery. We obtained one skin tissue patch from each of the 12 female patients with ages between 27 and 63 years old; 10 are Caucasian and 2 are African Americans, with the skin data compiled in table 1. Each skin patch was stored in a bucket on crushed ice ($\sim 2^\circ\text{C}$) inside a refrigerator immediately after surgery. Samples with sizes of about $1\text{ cm} \times 1\text{ cm}$ were prepared by removing the hair on the skin surface with scissors and subcutaneous fat tissue with a razor blade and warming the skin to a room temperature of about 22°C with 0.9% saline drops. Care was taken to preserve the stratum corneum layer of the skin epidermis. The skin sample was pressed against the base of the prism with a pistol pressurized by a nitrogen gas cylinder to maintain good contact between the sample and the prism. The periphery of the tissue sample between the pistol and prism base was sealed with plastic tape to prevent sample dehydration during the measurement. By pressing either the epidermis or dermis side of the skin sample against the prism base, the coherent reflectance curves of skin epidermis or dermis were measured, respectively. All reflectance curve measurements were performed at the room temperature within 30 h after the abdominoplasty procedure.

An automated reflectometer system has been designed and constructed to measure the coherent reflectance as a function of incident angle. Compared to other approaches of index determination based on fibre insertion and OCT (Bolin *et al* 1989, Tearney *et al* 1995, Knuttel and Boehlau-Godau 2000), this method has the combined benefits of high accuracy, wide spectral capability and instrumentation simplicity. The system has been described in detail

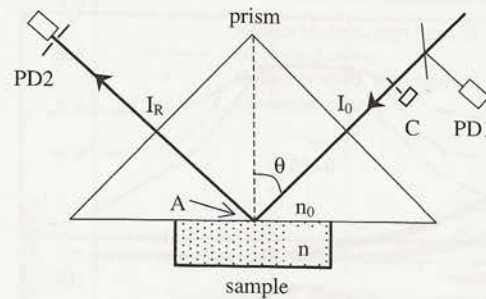

Figure 1. The schematic of the reflectometer system.

Table 1. The human skin sample data.

ID no.	Age	Race	Tissue location	Skin type	Measurement
1	42	Caucasian	Abdomen	III	Pressure dependence
2	40	Caucasian	Abdomen	I	633 nm, 532 nm
3	27	African American	Abdomen	V	442 nm
4	63	Caucasian	Abdomen	II	1064, 850 nm
5	56	Caucasian	Abdomen	II	325, 1550 nm
6	54	Caucasian	Arm	II	1310, 633 nm
7	34	Caucasian	Abdomen	II	1064, 325 nm
8 ^a	55	Caucasian	Abdomen	I	532, 633 nm
9 ^a	49	Caucasian	Abdomen	III	442, 1310 nm
10 ^a	41	Caucasian	Abdomen	II	850, 1550 nm
11 ^a	39	African American	Abdomen	V	532, diffuse reflection
12	44	Caucasian	Abdomen	III	Pressure dependence

^a The skin structures of the samples from these patients have been examined through histology.

elsewhere (Ding *et al* 2005). Briefly, a right-angle glass prism was used to interface with a skin sample on the prism base and a linear polarized laser beam was propagated through one side surface as the incident beam on the prism–sample interface at an incident angle of θ . The coherent reflectance R of the laser beam was measured at the angle of specular reflection by a photodiode of either Si or GaAs, depending on the light wavelength. Two coherent reflectance curves, $R_s(\theta)$ or $R_p(\theta)$, have actually been measured for each sample with either s- or p-polarized incident beam, respectively. The incident angle θ can be varied between 48° and 80° with a stepsize of 0.125° and resolution of 0.006° . A schematic diagram of the optical setup is presented in figure 1. The powers of the incident and reflected beams were measured by two identical photodiodes and the effect of the reflection loss at the side surfaces of the prism was removed to determine the coherent reflectance (R_s or R_p). To reduce the contribution of diffuse reflection to reflection signal, a pinhole of 2 mm diameter was used in front of the photodiode, resulting in an angular range of 1.74×10^{-2} rad or about 1.00° in the measurement. The incident laser beam, modulated at 370 Hz for lock-in detection, was produced by one of seven continuous-wave (cw) lasers at one of eight wavelengths: $\lambda = 325, 442, 532, 633, 850, 1064, 1310$ and 1557 nm. The diameter of the beam was set to between 1 and 2 mm with the incident beam power adjusted to be about $1 \mu\text{W}$.

The measured coherent reflectance curves have been fitted by the calculated values, $\tilde{R}_s(\theta)$ and $\tilde{R}_p(\theta)$, according to the Fresnel equations. The fitting requires the assumed value of the

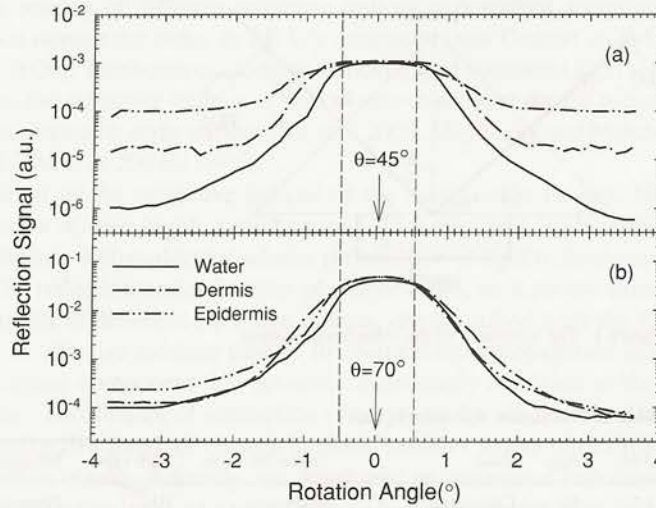

Figure 2. The reflection signal versus rotation angle of the detector at the incident angle of (a) $\theta = 45^\circ$; (b) $\theta = 70^\circ$ with a s-polarized beam at $\lambda = 633$ nm for deionized water, the epidermis and dermis of one skin sample. The error bars of about $\pm 5\%$ were removed for clear view and the two dashed lines indicate the angular acceptance range of the aperture in front of the photodiode.

complex refractive index of the turbid sample, $n = n_r + in_i$, and the known refractive index, n_0 , of the prism. Therefore, the index n was inversely determined using an iteration process to achieve least-squared difference between the calculated and measured curves (Ding *et al* 2005). The consistency between the measured and calculated coherent reflectance curves is described by a coefficient of determination, R^2 , defined as

$$R^2 = 1 - \frac{\sum_{i=1}^N (R_i - \tilde{R}_i)^2}{\sum_{i=1}^N (R_i - \bar{R})^2}, \quad (1)$$

where R_i and \tilde{R}_i denote the measured and calculated reflectances at the i th angle of incidence θ_i , respectively, and \bar{R} is the mean value of measured reflectance over N values of θ . The R^2 value ranges between 0 and 1 with $R^2 = 1$ for a perfect fit. The system was calibrated before measurements of each sample by comparing the measured real refractive index of deionized water with the published value at the wavelength of measurements (Hale and Querry 1973). From the water data, the experimental error in determination of the real refractive index n_r of transparent samples by the reflectometer system was found to be about $\delta n_r = \pm 0.002$.

3. Results

To ensure that the reflection signal is dominated by its coherent component, we measured the angular distribution of the reflected beam around a specular reflection angle at two positions ($\theta = 45^\circ$ or 75°) with $\lambda = 633$ nm. Similar data with deionized water were used as the baseline and all are plotted in figure 2. These results demonstrate that the contribution of the diffusely reflected light to the coherent reflectance signal is negligible within the 1° angular range defined by the photodiode aperture (indicated by the dashed lines in figure 2). Two typical sets of coherent reflectance curves from the epidermis and dermis sides of the skin

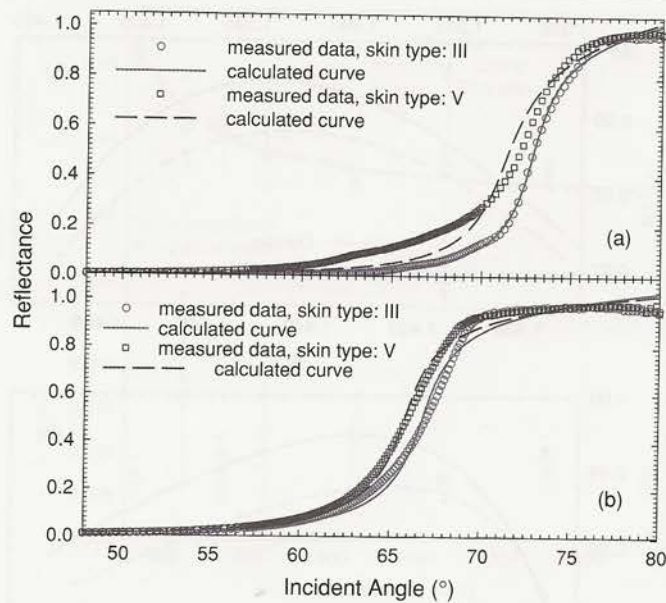

Figure 3. The typical measured coherent reflectance curves of two skin samples from two patients at $\lambda = 442$ nm with a s-polarized incident beam: (a) epidermis, (b) dermis. The solid lines are calculated curves based on the Fresnel equations with the following values of the complex refractive index: (a) $n = 1.445 + i1.00 \times 10^{-2}$ for ID no. 3 (skin type: V) and $n = 1.458 + i8.34 \times 10^{-3}$ for ID no. 9 (skin type: III); (b) $n = 1.394 + i9.30 \times 10^{-3}$ for ID no. 3 and $n = 1.404 + i9.20 \times 10^{-3}$ for ID no. 9.

samples of two patients with different skin types are presented in figure 3 together with the fitted curves based on the Fresnel equations. From these results one can see that the agreement between the measured and calculated reflectance curves varies from sample to sample and is gauged by the coefficient of determination R^2 . To determine the sensitivity of the refractive index on the nonlinear regression, we analysed the relation between R^2 and n with selected data of the coherent reflection curves and typical results are presented in figure 4. On the basis of the standard deviations in the distribution of R^2 values, we estimated that the uncertainty in obtaining the real and imaginary is about $\Delta n_r = \pm 0.006$ and $\Delta n_i = \pm 0.005$, respectively, for the turbid tissues of both the epidermis and dermis.

To select an appropriate pressure applied to the skin tissue sample for achieving good contact between the sample and prism with minimal tissue damage, we determined the complex refractive index from two skin samples as a function of the pressure, as shown in figure 5. It can be seen from the data that the real index is not sensitive to the air pressure set between 2×10^5 and 5×10^5 Pa. Signs of damage to the skin samples became visible when the pressure was increased to above 4×10^5 Pa, which included the fast dehydration of the tissue samples and significant reduction in the dermis layer thickness. On the basis of these results, all subsequent measurements of coherent reflectance of skin tissue samples were carried out at a fixed pressure of 2.06×10^5 Pa (30 psi or 2.0 atm) to minimize possible structural change in the skin tissues.

At each wavelength, 8 or 12 skin samples were used to measure the coherent reflectance curves of $R_s(\theta)$ and $R_p(\theta)$ with 4 from one patient. Half of the samples were measured with the epidermis side in contact with the prism base and half with the dermis side. The measurement of $R_s(\theta)$ and $R_p(\theta)$ was repeated three times on the same skin sample and thus the data set

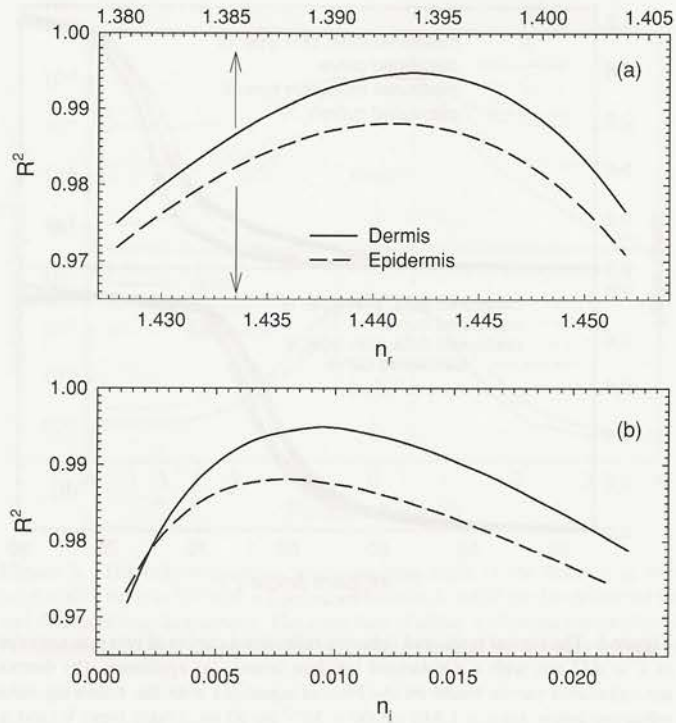

Figure 4. The dependence of the coefficient of determination R^2 on different choices of n_i for a coherent reflectance curve measured from the epidermis and dermis sides of a skin sample at $\lambda = 442$ nm.

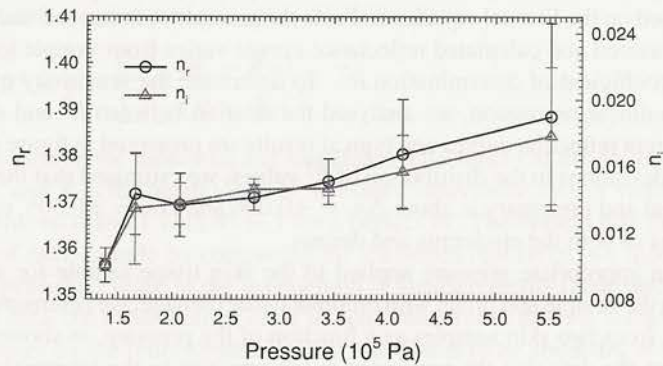

Figure 5. The average real and imaginary refractive index versus sample pressure determined from the dermis of two skin samples.

at each wavelength consists of 12 or 18 curves with an incident beam of s- or p-polarization. Nonlinear regression to the coherent reflectance curve data by the Fresnel equations was done individually to obtain the complex refractive index from each measurement. The coefficient of determination R^2 ranges from 0.960 to 0.999 for the data from the measurement of the epidermis side and from 0.978 to 0.998 for the dermis side. The mean values and standard deviations of the complex refractive index have been calculated at each wavelength from the

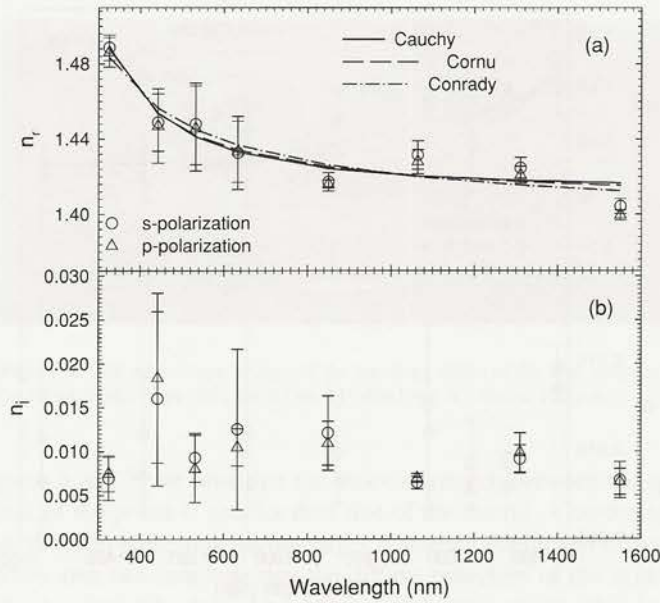

Figure 6. The (a) real and (b) imaginary refractive indices of human skin epidermis versus wavelength. Each data point and associated error bar is the mean and standard deviation obtained from 12 or 18 measurements of 4 or 6 skin samples. The lines in (a) are based on the dispersion equations.

data sets. These results are plotted as a function of wavelength in figure 6 for the epidermis and figure 7 for the dermis.

We investigated various dispersion schemes to identify appropriate ones for calculation of real refractive index of human skin tissues at wavelengths between 300 and 1600 nm based on our index data at eight wavelengths. Among those reported on the index data of ocular tissues (Kroger 1992, Atchison and Smith 2005), we selected three schemes to fit to our data: the Cauchy dispersion equation

$$n_r = A + \frac{B}{\lambda^2} + \frac{C}{\lambda^4}, \quad (2)$$

the Cornu equation

$$n_r = A + \frac{B}{(\lambda - C)} \quad (3)$$

and the Conrady equation

$$n_r = A + \frac{B}{\lambda} + \frac{C}{\lambda^{3.5}}. \quad (4)$$

The coefficients of each dispersion scheme determined with the least-squares principle from our index data are given in table 2.

4. Discussion

Refractive index plays an important role in characterization of the biological tissues' response to optical illumination, particularly for tissues of heterogeneous composition such as the layered skin tissues (Tuchin 2005). The real refractive index not only influences optical

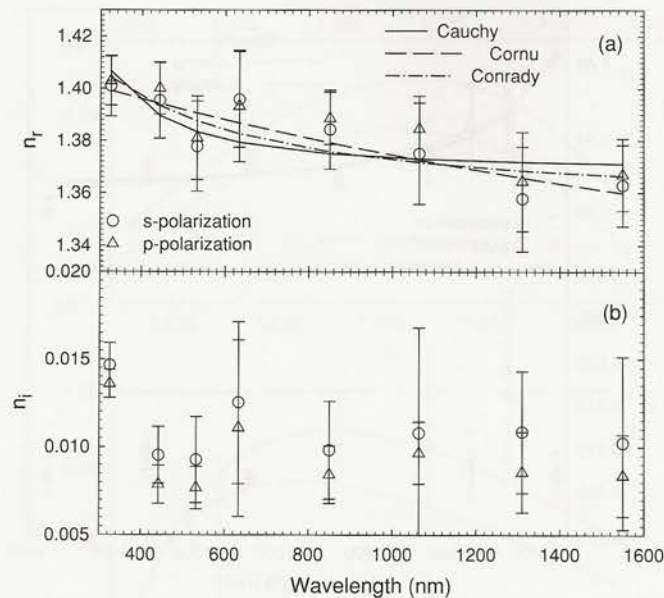

Figure 7. The (a) real and (b) imaginary refractive indices of human skin dermis versus wavelength. Each data point and associated error bar is the mean and standard deviation obtained from 12 or 18 measurements of 4 or 6 skin samples. The lines in (a) are based on the dispersion equations.

Table 2. The coefficients of different dispersion equations^a.

Dispersion equation	A	B	C
Cauchy	1.3696	3.9168×10^3	2.5588×10^3
Cornu	1.2573	4.5383×10^2	2.8745×10^3
Conrady	1.3549	1.7899×10	-3.5938×10^6

^a These coefficients were obtained on the basis of equations (2)–(4) with wavelength in the unit of nanometres.

pathlengths of light propagating in tissues that can be determined by the methods of phase or time-resolved spectroscopy (Duncan *et al* 1995, Zhao *et al* 2002) but also affects the light measurement outside the tissues due to the index mismatch at the boundaries (Meglinsky and Matcher 2001, Bartlett and Jiang 2001, Ma *et al* 2003b, 2005). With an automated reflectometer system, we have extended the technique of measuring the coherent reflectance curve (Meeten and North 1995, Ding *et al* 2005) to obtain the complex refractive indices of fresh human skin tissues. These results, therefore, are of interest to researchers wishing to conduct quantitative optical studies involving index-mismatched interfaces in the human skin.

The measurement of coherent reflectance was validated by confirming the dominance of the coherent reflection over the diffused one at the specular reflection angle for both of the epidermis and dermis sides of the skin samples, as shown in figure 2. Diffuse reflection occurs mainly outside the angular range defined by the aperture of the photodiode PD2 (see figure 1) and decreases towards the baseline data of water for large incident angles as θ approaches 80° . The diffusely reflected light originates from two sources: the rough tissue surface mismatched optically with the prism glass and the tissue bulk. From the index data

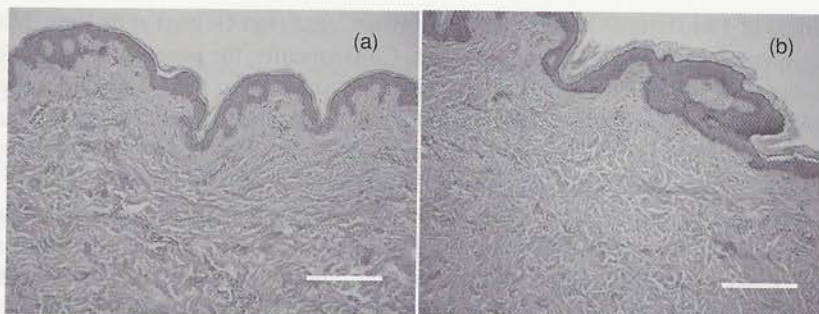

Figure 8. The microscope images of the histology slides of the skin samples from two patients: (a) ID no. 9 (skin type: III); (b) ID no. 11 (skin type: V). Bar = 100 μm .

presented in figures 6 and 7, we note that the index mismatch between the epidermis tissue and the BK7 glass of the prism is smaller than that of the dermis. Combining this fact with the knowledge of the skin epidermis having larger scattering coefficient than the dermis (van Gemert *et al* 1989), one can conclude that the diffuse reflection of the skin tissues seen in figure 2 should be dominated by the light scattering in the tissue bulk. This is consistent with our previous results on comparison of the diffuse reflection between the porcine skin tissues with rough surfaces and the intralipid solution samples with smooth surface (Ding *et al* 2005).

The human skin has a layered structure with two primary layers of epidermis and dermis, both are beneath the superficial layer of the epidermis or the stratum corneum (sc). We examined the tissue structures by preparing histological slides of the skin tissue samples from 4 patients (with ID no. from 8 to 11, see table 1) with standard H&E staining. Two examples of skin slides are shown in figure 8 with one from a Caucasian and another from an African American patient. It can be seen that the sc layer is less than 10 μm in thickness, as expected, with the thickness of epidermis ranging from about 30 to 80 μm . We further verified that the sc layer has no significant effect on the refractive index determination by comparing the index values from samples with and without the sc layer prepared from fresh porcine skin tissues. The sc layer was removed from the epidermal side of the porcine tissue samples using a tape-stripping method (Beisson *et al* 2001) without heating the samples. The real refractive index n_r of the epidermis at the wavelengths of 442 nm and 1064 nm was found to be the same within the experimental errors between the samples with and without the sc layer. These results demonstrated that the sc layer has no significant effect on the real refractive index of the skin epidermis because of its small thickness in comparison with the penetration depth (Everett *et al* 1966, van Gemert *et al* 1989), see also the discussion below. Another point worth noting is the effect of the melanin on the refractive index of the skin tissues. As can be seen from figure 8, many basal keratinocytes containing melanin pigment are visible near the epidermal–dermal junction in patient no. 11 (skin type: V), while little pigment exists in patient no. 9 (skin type III). The high density of melanin in the type V skins appears only to affect significantly the imaginary refractive index of epidermis, as shown in figure 3.

A general model of refractive index for a dense and turbid medium remains an open question. But according to the existing models of effective medium for absorbing or dilute turbid media (Ballenegger and Weber 1999, Barrera and Garcia-Valenzuela 2003) the refractive index determined from a coherent reflectance curve should relate to the medium's optical response from over at least the full depth of penetration of the coherent component of the incident wave in the medium. The total attenuation coefficients, as the sum of the scattering and absorption coefficients, for both the skin epidermis and dermis are expected to be on the

orders of 1 to 10 mm^{-1} based on the published data (van Gemert *et al* 1989, Ma *et al* 2005) in the spectral region from 300 to 1600 nm. Consequently, the penetration depth for the coherent component should be about a few hundred micrometres or less. Therefore, one would expect the tissue response of the first $100 \mu\text{m}$ layer to dominate the coherent reflectance and thus the value of the real refractive index. This conclusion is supported by the wavelength correlation of the real refractive index determined from the epidermis and dermis sides of the skin tissue samples. The correlation coefficient of wavelength dependence of the real refractive index was found to be $r_{\text{corr}} = 0.99$ between the index determined with s- and p-polarized beam for the epidermis and $r_{\text{corr}} = 0.95$ for the dermis. The values of r_{corr} decrease drastically to 0.057 and 0.065 between the index of epidermis and dermis measured with the s- and p-polarized beam, respectively.

Within the previously discussed uncertainty on the real refractive index, our *in vitro* results of n_r at about $\lambda = 1310 \text{ nm}$ agree with those determined *in vivo* from human skin epidermis (averaged over the sc and other sub-layers) by the OCT method (Tearney *et al* 1995, Knuttel and Boehlau-Godau 2000). The n_r of dermis, however, is smaller than the above reported *in vivo* results: 1.36 versus 1.41 at about $\lambda = 1310 \text{ nm}$. The wavelength dependence is similar to the n_r of bovine and porcine muscle tissues in the visible region (Bolin *et al* 1989, Li and Xie 1996). To extend the use of our real refractive index data on a limited number of wavelengths, we have tested different dispersion schemes based on the equations by Cauchy, Cornu and Conrady. From figures 6 and 7, it is clear that these relations are close to each other and all fit to data fairly well for the dermis and very well for the epidermis. Therefore, these equations may be used to estimate the values of the real refractive indices of human skin tissues with the coefficients given in table 2 between 300 and 1600 nm. These estimations should be further improved as the refractive index becomes available at an increased number of wavelengths in this spectral region.

Acknowledgments

JQL and XHH acknowledge partial support by a NIH grant (1R15GM70798-01). Comments and correspondence should be sent to X H Hu: hux@mail.ecu.edu.

References

- Atchison D A and Smith G 2005 Chromatic dispersions of the ocular media of human eyes *J. Opt. Soc. Am. A Opt. Image Sci. Vis.* **22** 29–37
- Ballenegger V C and Weber T A 1999 The Ewald–Oseen extinction theorem and extinction lengths *Am. J. Phys.* **67** 599–605
- Barrera R G and Garcia-Valenzuela A 2003 Coherent reflectance in a system of random Mie scatterers and its relation to the effective-medium approach *J. Opt. Soc. Am. A Opt. Image Sci. Vis.* **20** 296–311
- Bartlett M A and Jiang H 2001 Effect of refractive index on the measurement of optical properties in turbid media *Appl. Opt.* **40** 1735–41
- Beisson F, Aoubala M, Marull S, Moustacas-Gardies A M, Voultoury R, Verger R and Arondel V 2001 Use of the tape stripping technique for directly quantifying esterase activities in human stratum corneum *Anal. Biochem.* **290** 179–85
- Bohren C F and Huffman D R 1983 *Absorption and Scattering of Light by Small Particles* (New York: Wiley)
- Bolin F P, Preuss L E, Taylor R C and Ferenec R J 1989 Refractive index of some mammalian tissues using a fiber optic cladding method *Appl. Opt.* **28** 2297–303
- Ding H, Lu J Q, Jacobs K M and Hu X H 2005 Determination of refractive indices of porcine skin tissues and intralipid at eight wavelengths between 325 and 1557 nm *J. Opt. Soc. Am. A* **22** 1151–7
- Duncan A, Meek J H, Clemence M, Elwell C E, Tyszczyk L, Cope M and Delpy D T 1995 Optical pathlength measurements on adult head, calf and forearm and the head of the newborn infant using phase resolved optical spectroscopy *Phys. Med. Biol.* **40** 295–304

- Everett M A, Yeagers E, Sayre R M and Olson R L 1966 Penetration of epidermis by ultraviolet rays *Photochem. Photobiol.* **5** 533–42
- Hale G and Querry M 1973 Optical constants of water in the 200 nm to 200 micrometer wavelength region *Appl. Opt.* **12** 555–63
- Knüttel A and Boehlau-Godau M 2000 Spatially confined and temporally resolved refractive index and scattering evaluation in human skin performed with optical coherence tomography *J. Biomed. Opt.* **5** 83–92
- Kroger R H H 1992 Methods to estimate dispersion in vertebrate ocular media *J. Opt. Soc. Am. A Opt. Image Sci. Vis.* **9** 1486–90
- Li H and Xie S 1996 Measurement method of the refractive index of biotissue by total internal reflection *Appl. Opt.* **35** 1793–5
- Lu J Q, Hu X H and Dong K 2000 Modeling of the rough-interface effect on a converging light beam propagating in a skin tissue phantom *Appl. Opt.* **39** 5890–7
- Lu J Q, Yang P and Hu X H 2005 Simulations of light scattering from a biconcave red blood cell using the FDTD method *J. Biomed. Opt.* **10** 024022
- Ma X, Lu J Q, Brock R S, Jacobs K M, Yang P and Hu X H 2003a Determination of complex refractive index of polystyrene microspheres from 370 to 1610 nm *Phys. Med. Biol.* **48** 4165–72
- Ma X, Lu J Q, Ding H and Hu X H 2005 Bulk optical parameters of porcine skin dermis tissues at eight wavelengths from 325 to 1557 nm *Opt. Lett.* **30** 412–4
- Ma X, Lu J Q and Hu X H 2003b Effect of surface roughness on determination of bulk tissue optical parameters *Opt. Lett.* **28** 2204–6
- Meeten G H and North A N 1995 Refractive index measurement of absorbing and turbid fluids by reflection near the critical angle *Meas. Sci. Technol.* **6** 214–21
- Meglinsky I V and Matcher S J 2001 Modelling the sampling volume for skin blood oxygenation measurements *Med. Biol. Eng. Comput.* **39** 44–50
- Tearney G J, Brezinski M E, Southern J F, Bouma B E, Hee M R and Fujimoto J G 1995 Determination of the refractive index of highly scattering human tissue by optical coherence tomography *Opt. Lett.* **20** 2258–60
- Tuchin V V 2005 Optical clearing of tissues and blood using the immersion method *J. Phys. D: Appl. Phys.* **38** 2497–518
- van Gemert M J, Jacques S L, Sterenborg H J and Star W M 1989 Skin optics *IEEE Trans. Biomed. Eng.* **36** 1146–54
- Wang L, Jacques S L and Zheng L 1995 MCML—Monte Carlo modeling of light transport in multi-layered tissues *Comput. Methods Prog. Biomed.* **47** 131–46
- Zhao H, Tanikawa Y, Gao F, Onodera Y, Sassaroli A, Tanaka K and Yamada Y 2002 Maps of optical differential pathlength factor of human adult forehead, somatosensory motor and occipital regions at multi-wavelengths in NIR *Phys. Med. Biol.* **47** 2075–93

DING02

🔍 Covid 19 updates and more information about using the Libraries while you're remote.



Catalog

Bookmarks 0 Course Reserves My Account

Keyword Search...

Search

Advanced search Start Over

Share

Bookmark

Report an Issue

MARC View

LEADER 23528nas a2202605 4500
001 1296394
003 SIRSI
005 20160707134018.0
008 820805c19569999enksr p 0 a0eng d
010 a| 58049741
019 a| MARS
022 0 a| 0031-9155
032 a| 979020 b| USPS
035 a| LIAS1523350
035 a| (OCoLC)1762343
040 a| PSt c| PSt d| WaOLN d| UtOrBLW
050 0 0 a| QH505 b| .P47
245 0 0 a| Physics in medicine & biology.
246 3 a| Physics in medicine and biology
264 1 a| London : b| Hospital Physicists Association, c| 1956-
300 a| volumes : b| illustrations ; c| 26 cm
310 a| Semimonthly, b| 2002-
321 a| Frequency varies, b| 1956-2001
336 a| text b| txt 2| rdacontent
337 a| unmediated b| n 2| rdamedia
338 a| volume b| nc 2| rdacarrier
362 0 a| v.1- July 1956-
546 a| Texts and summaries in English, French, or German.
550 a| "Journal of the Hospital Physicists' Association."
550 a| Official journal of the Hospital Physicists' Association, 1956- ; the American Association of Physicists in Medicine, 1964-1973; the Medical and Biological Physics Division, Canadian Association of Physicists, 1965- ; the International Organization for Medical Physics, 1970- ; and the Deutsche Gesellschaft für Medizinische Physik, 1982?-
650 0 a| Biophysics v| Periodicals.
650 0 a| Medical physics v| Periodicals.
650 2 a| Biology.
650 2 a| General Medicine.
650 2 a| Physics x| perioicals.
655 2 a| Periodicals.
710 2 a| Hospital Physicists' Association.
710 2 a| Canadian Association of Physicists. b| Medical and Biological Physics Division.
710 2 a| International Organization for Medical Physics.
710 2 a| American Institute of Physics.
710 2 a| Deutsche Gesellschaft für Medizinische Physik.
710 2 a| American Association of Physicists in Medicine.
949 a| QH505.P47 v.1-2 1956-58 w| LCPER c| 1 i| 000073470977 d| 12/11/1995 l| PATERNO-4 m| UP-PAT r| Y s| Y t| PERIODICAL u| 4/13/2001
949 a| QH505.P47 v.48 no.10-12 p1239-1862 2003 w| LCPER c| 1 i| 000052544989 l| STACKS-PM m| UP-PAMS r| Y s| Y t| PERIODICAL u| 9/2/2003
949 a| QH505.P47 v.48 no.7-9 p.805-1238 2003 w| LCPER c| 1 i| 000052544972 l| STACKS-PM m| UP-PAMS r| Y s| Y t| PERIODICAL u| 9/2/2003
949 a| QH505.P47 v.48 no.4-6 p.417-804 2003 w| LCPER c| 1 i| 000052544958 l| STACKS-PM m| UP-PAMS r| Y s| Y t| PERIODICAL u| 9/2/2003
949 a| QH505.P47 v.48 no.1-3 p.1-416 2003 w| LCPER c| 1 i| 000052544965 l| STACKS-PM m| UP-PAMS r| Y s| Y t| PERIODICAL u| 9/2/2003
949 a| QH505.P47 v.48 no.16-18 p2577-3100 2003 w| LCPER c| 1 i| 000052568572 l| BDJNL-PM m| UP-PAMS r| Y s| Y t| PERIODICAL u| 10/13/2003

949	a QH505.P47 v.48 no.13-15 p1863-2576 2003 w LCPER c 1 i 000052568589 BDJNL-PM m UP-PAMS r Y s Y t PERIODICAL u 10/13/2003
949	a QH505.P47 v.48 no.22-24 2003 w LCPER c 1 i 000052791819 BDJNL-PM m UP-PAMS r Y s Y t PERIODICAL u 2/10/2004
949	a QH505.P47 v.48 no.19-21 p3101-3624 2003 w LCPER c 1 i 000052791802 BDJNL-PM m UP-PAMS r Y s Y t PERIODICAL u 2/10/2004
949	a QH505.P47 v.49 no.4-6 2004 w LCPER c 1 i 000052755507 CATO-PARK m UP-ANNEX r Y s Y t PERIODICAL u 8/30/2004 z 4635
949	a QH505.P47 v.49 no.10-12 2004 w LCPER c 1 i 000052755514 CATO-PARK m UP-ANNEX r Y s Y t PERIODICAL u 8/30/2004 z 4635
949	a QH505.P47 v.49 no.7-9 2004 w LCPER c 1 i 000052755521 CATO-PARK m UP-ANNEX r Y s Y t PERIODICAL u 8/30/2004 z 4635
949	a QH505.P47 v.49 no.1-3 2004 w LCPER c 1 i 000052755378 CATO-PARK m UP-ANNEX r Y s Y t PERIODICAL u 8/30/2004 z 4635
949	a QH505.P47 v.49 no.13-14 2004 w LCPER c 1 i 000054914063 CATO-PARK m UP-ANNEX r Y s Y t PERIODICAL u 2/3/2005 z 4635
949	a QH505.P47 v.49 no.15-16 2004 w LCPER c 1 i 000054914070 CATO-PARK m UP-ANNEX r Y s Y t PERIODICAL u 2/3/2005 z 4635
949	a QH505.P47 v.49 no.17-18 2004 w LCPER c 1 i 000054914087 CATO-PARK m UP-ANNEX r Y s Y t PERIODICAL u 2/3/2005 z 4635
949	a QH505.P47 v.49 no.19-20 2004 w LCPER c 1 i 000054914162 CATO-PARK m UP-ANNEX r Y s Y t PERIODICAL u 2/3/2005 z 4635
949	a QH505.P47 v.49 no.21-22 2004 w LCPER c 1 i 000054914155 CATO-PARK m UP-ANNEX r Y s Y t PERIODICAL u 2/3/2005 z 4635
949	a QH505.P47 v.49 no.23-24 2004 w LCPER c 1 i 000054918955 CATO-PARK m UP-ANNEX r Y s Y t PERIODICAL u 5/13/2005 z 4635
949	a QH505.P47 v.50 no.1-2 2005 w LCPER c 1 i 000054918962 CATO-PARK m UP-ANNEX r Y s Y t PERIODICAL u 5/13/2005 z 4635
949	a QH505.P47 v.50 no.3-4 2005 w LCPER c 1 i 000067506514 CATO-PARK m UP-ANNEX r Y s Y t PERIODICAL u 5/19/2005 z 4635
949	a QH505.P47 v.50 no.5-6 2005 w LCPER c 1 i 000054922594 CATO-PARK m UP-ANNEX r Y s Y t PERIODICAL u 6/20/2005 z 4635
949	a QH505.P47 v.50 no.7-8 2005 w LCPER c 1 i 000052758980 CATO-PARK m UP-ANNEX r Y s Y t PERIODICAL u 7/8/2005 z 4635
949	a QH505.P47 v.50 no.9-10 2005 w LCPER c 1 i 000052758973 CATO-PARK m UP-ANNEX r Y s Y t PERIODICAL u 7/8/2005 z 4635
949	a QH505.P47 v.50 no.11-12 2005 w LCPER c 1 i 000054924550 CATO-PARK m UP-ANNEX r Y s Y t PERIODICAL u 9/8/2005 z 4635
949	a QH505.P47 v.50 no.13-14 2005 w LCPER c 1 i 000054917194 CATO-PARK m UP-ANNEX r Y s Y t PERIODICAL u 9/29/2005 z 4635
949	a QH505.P47 v.50 no.15-16 2005 w LCPER c 1 i 000054928251 CATO-PARK m UP-ANNEX r Y s Y t PERIODICAL u 11/16/2005 z 4635
949	a QH505.P47 v.50 no.19-20 2005 w LCPER c 1 i 000054929371 CATO-PARK m UP-ANNEX r Y s Y t PERIODICAL u 1/19/2006 z 4635
949	a QH505.P47 v.50 no.17-18 2005 w LCPER c 1 i 000054929388 CATO-PARK m UP-ANNEX r Y s Y t PERIODICAL u 1/20/2006 z 4635
949	a QH505.P47 v.50 no.21-22 2005 w LCPER c 1 i 000054930438 CATO-PARK m UP-ANNEX r Y s Y t PERIODICAL u 2/20/2006 z 4635
949	a QH505.P47 v.50 no.23-24 2005 w LCPER c 1 i 000054930445 CATO-PARK m UP-ANNEX r Y s Y t PERIODICAL u 2/20/2006 z 4635
949	a QH505.P47 v.51 no.10-11 2006 w LCPER c 1 i 000054939400 CATO-PARK m UP-ANNEX r Y s Y t PERIODICAL u 3/21/2007 z 4635
949	a QH505.P47 v.51 no.12-13 2006 w LCPER c 1 i 000054931930 CATO-PARK m UP-ANNEX r Y s Y t PERIODICAL u 3/21/2007 z 4635
949	a QH505.P47 v.51 no.14-15 2006 w LCPER c 1 i 000054932005 CATO-PARK m UP-ANNEX r Y s Y t PERIODICAL u 3/21/2007 z 4635
949	a QH505.P47 v.52 no.11-12 2007 w LC c 1 i 000055148641 CATO-PARK m UP-ANNEX r Y s Y t PERIODICAL u 11/13/2007 z 4635
949	a QH505.P47 v.51 no.22-24 2006 w LC c 1 i 000055148658 CATO-PARK m UP-ANNEX r Y s Y t PERIODICAL u 11/13/2007 z 4635
949	a QH505.P47 v.52 no.5-6 2007 w LC c 1 i 000055148665 CATO-PARK m UP-ANNEX r Y s Y t PERIODICAL u 11/13/2007 z 4635
949	a QH505.P47 v.52 no.3-4 2007 w LC c 1 i 000055148672 CATO-PARK m UP-ANNEX r Y s Y t PERIODICAL u 11/13/2007 z 4635
949	a QH505.P47 v.51 no.16-17 2006 w LC c 1 i 000055148689 CATO-PARK m UP-ANNEX r Y s Y t PERIODICAL u 11/13/2007 z 4635
949	a QH505.P47 v.52 no.7-8 2007 w LC c 1 i 000055148696 CATO-PARK m UP-ANNEX r Y s Y t PERIODICAL u 11/13/2007 z 4635
949	a QH505.P47 v.51 no.20-21 2006 w LC c 1 i 000055148702 CATO-PARK m UP-ANNEX r Y s Y t PERIODICAL u 11/13/2007 z 4635

	z 4635
949	a QH505.P47 v.51 no.18-19 2006 w LC c 1 i 000055148719 CATO-PARK m UP-ANNEX r Y s Y t PERIODICAL u 11/13/2007 z 4635
949	a QH505.P47 v.52 no.9-10 2007 w LC c 1 i 000055148726 CATO-PARK m UP-ANNEX r Y s Y t PERIODICAL u 11/13/2007 z 4635
949	a QH505.P47 v.52 no.1-2 2007 w LC c 1 i 000055148733 CATO-PARK m UP-ANNEX r Y s Y t PERIODICAL u 11/14/2007 z 4635
949	a Periodical 1996 41 JA-JN w ASIS c 1 i 32239000807756 CATO-2 m UP-ANNEX r Y s Y t PERIODICAL u 12/13/2001 z 7882
949	a Periodical 1996 41 JL-SE w ASIS c 1 i 32239000813259 CATO-2 m UP-ANNEX r Y s Y t PERIODICAL u 12/13/2001 z 7882
949	a Periodical 1996 41 OC-DE w ASIS c 1 i 32239000813267 d 7/20/2007 CATO-2 m UP-ANNEX q 3 r Y s Y t PERIODICAL u 12/13/2001 z 7882
949	a Periodical 1997 42 JA-JN w ASIS c 1 i 32239000827226 d 9/18/2012 CATO-2 m UP-ANNEX q 1 r Y s Y t PERIODICAL u 12/13/2001 z 7882
949	a Periodical 1997 42 JL-DE w ASIS c 1 i 32239001757513 CATO-2 m UP-ANNEX r Y s Y t PERIODICAL u 12/13/2001 z 7882
949	a Periodical 1998 43 JA-AP w ASIS c 1 i 32239001775176 d 9/15/2003 CATO-2 m UP-ANNEX q 2 r Y s Y t PERIODICAL u 12/13/2001 z 7882
949	a Periodical 1998 43 MY-AU w ASIS c 1 i 32239001775184 CATO-2 m UP-ANNEX r Y s Y t PERIODICAL u 12/13/2001 z 7882
949	a Periodical 1998 43 SE-DE w ASIS c 1 i 32239001782800 CATO-2 m UP-ANNEX r Y s Y t PERIODICAL u 12/13/2001 z 7882
949	a Periodical 1999 44 JA-AP w ASIS c 1 i 32239001795315 CATO-2 m UP-ANNEX r Y s Y t PERIODICAL u 12/13/2001 z 7882
949	a Periodical 1999 44 MY-AU w ASIS c 1 i 32239001804984 d 1/12/2006 CATO-2 m UP-ANNEX q 1 r Y s Y t PERIODICAL u 12/13/2001 z 7882
949	a Periodical 1999 44 SE-DE w ASIS c 1 i 32239001808936 d 2/10/2005 CATO-2 m UP-ANNEX q 1 r Y s Y t PERIODICAL u 12/13/2001 z 7882
949	a QH505.P47 v.54 no.19-21 2009 w LCPER c 1 i 000061792227 CATO-PARK m UP-ANNEX r Y s Y t PERIODICAL u 6/18/2010 z 4635
949	a QH505.P47 v.54 no.22-23 2009 w LCPER c 1 i 000061792241 CATO-PARK m UP-ANNEX r Y s Y t PERIODICAL u 6/18/2010 z 4635
949	a QH505.P47 v.54 no.13-15 2009 w LCPER c 1 i 000061792326 CATO-PARK m UP-ANNEX r Y s Y t PERIODICAL u 6/18/2010 z 4635
949	a QH505.P47 v.54 no.16-18 2009 w LCPER c 1 i 000061792319 CATO-PARK m UP-ANNEX r Y s Y t PERIODICAL u 6/18/2010 z 4635
949	a QH505.P47 v.52 no.13-15 2007 w LCPER c 1 i 000061797628 CATO-PARK m UP-ANNEX r Y s Y t PERIODICAL u 7/12/2010 z 4635
949	a QH505.P47 v.53 no.19-21 2008 w LCPER c 1 i 000061797635 CATO-PARK m UP-ANNEX r Y s Y t PERIODICAL u 7/12/2010 z 4635
949	a QH505.P47 v.53 no.22-24 2008 w LCPER c 1 i 000061797642 CATO-PARK m UP-ANNEX r Y s Y t PERIODICAL u 7/12/2010 z 4635
949	a QH505.P47 v.54 no.7-9 2009 w LCPER c 1 i 000061797659 CATO-PARK m UP-ANNEX r Y s Y t PERIODICAL u 7/12/2010 z 4635
949	a QH505.P47 v.54 no.10-12 2009 w LCPER c 1 i 000061797666 CATO-PARK m UP-ANNEX r Y s Y t PERIODICAL u 7/12/2010 z 4646
949	a QH505.P47 v.54 no.1-3 2009 w LCPER c 1 i 000061797673 CATO-PARK m UP-ANNEX r Y s Y t PERIODICAL u 7/12/2010 z 4635
949	a QH505.P47 v.54 no.4-6 2009 w LCPER c 1 i 000061797680 CATO-PARK m UP-ANNEX r Y s Y t PERIODICAL u 7/12/2010 z 4635
949	a QH505.P47 v.53 no.13-15 2008 w LCPER c 1 i 000061797697 CATO-PARK m UP-ANNEX r Y s Y t PERIODICAL u 7/12/2010 z 4635
949	a QH505.P47 v.53 no.16-18 2008 w LCPER c 1 i 000061797703 CATO-PARK m UP-ANNEX r Y s Y t PERIODICAL u 7/12/2010 z 4635
949	a QH505.P47 v.53 no.7-9 2008 w LCPER c 1 i 000061776036 CATO-PARK m UP-ANNEX r Y s Y t PERIODICAL u 7/12/2010 z 4635
949	a QH505.P47 v.53 no.10-12 2008 w LCPER c 1 i 000061776043 CATO-PARK m UP-ANNEX r Y s Y t PERIODICAL u 7/12/2010 z 4635
949	a QH505.P47 v.53 no.1-3 2008 w LCPER c 1 i 000061776050 CATO-PARK m UP-ANNEX r Y s Y t PERIODICAL u 7/12/2010 z 4635
949	a QH505.P47 v.53 no.4-6 2008 w LCPER c 1 i 000061776067 CATO-PARK m UP-ANNEX r Y s Y t PERIODICAL u 7/12/2010 z 4635
949	a QH505.P47 v.52 no.16-18 2007 w LCPER c 1 i 000061776074 CATO-PARK m UP-ANNEX r Y s Y t PERIODICAL u 7/12/2010 z 4635
949	a QH505.P47 v.52 no.19-21 2007 w LCPER c 1 i 000061776081 CATO-PARK m UP-ANNEX r Y s Y t PERIODICAL u 7/12/2010 z 4635
949	a QH505.P47 v.52 no.22-24 2007 w LCPER c 1 i 000061797611 CATO-PARK m UP-ANNEX r Y s Y t PERIODICAL u 7/12/2010 z 4635
949	a QH505.P47 v.55 no.10-12 2010 w LCPER c 1 i 000059320494 CATO-PARK m UP-ANNEX r Y s Y t PERIODICAL u 10/11/2010 z 4646
949	a QH505.P47 v.55 no.4-6 2010 w LCPER c 1 i 000059320500 CATO-PARK m UP-ANNEX r Y s Y t PERIODICAL u 10/11/2010 z 4646

949	a	QH505.P47 v.55 no.1-3 2010 w	LCPER c	1 i	000059320524 I	CATO-PARK m	UP-ANNEX r	Y s	Y t	PERIODICAL u	10/11/2010 z	4646
949	a	QH505.P47 v.55 no.7-9 2010 w	LCPER c	1 i	000059320548 I	CATO-PARK m	UP-ANNEX r	Y s	Y t	PERIODICAL u	10/11/2010 z	4646
949	a	QH505.P47 v.55 no.13-15 2010 w	LCPER c	1 i	000059343219 I	CATO-PARK m	UP-ANNEX r	Y s	Y t	PERIODICAL u	8/25/2011 z	4646
949	a	QH505.P47 v.55 no.16-18 2010 w	LCPER c	1 i	000059343226 I	CATO-PARK m	UP-ANNEX r	Y s	Y t	PERIODICAL u	8/25/2011 z	4646
949	a	QH505.P47 v.55 no.19-21 2010 w	LCPER c	1 i	000059343233 I	CATO-PARK m	UP-ANNEX r	Y s	Y t	PERIODICAL u	8/25/2011 z	4646
949	a	QH505.P47 v.56 no.4-6 2011 w	LCPER c	1 i	000059343240 I	CATO-PARK m	UP-ANNEX r	Y s	Y t	PERIODICAL u	8/25/2011 z	4646
949	a	QH505.P47 v.55 no.22-24 2010 w	LCPER c	1 i	000059343387 I	CATO-PARK m	UP-ANNEX r	Y s	Y t	PERIODICAL u	8/25/2011 z	4646
949	a	QH505.P47 v.56 no.1-3 2011 w	LCPER c	1 i	000059343394 I	CATO-PARK m	UP-ANNEX r	Y s	Y t	PERIODICAL u	8/25/2011 z	4646
949	a	QH505.P47 v.56 no.22-24 2011 w	LCPER c	1 i	000059332237 I	CATO-PARK m	UP-ANNEX r	Y s	Y t	PERIODICAL u	3/5/2013 z	4646
949	a	QH505.P47 v.56 no.13-14 2011 w	LCPER c	1 i	000059356264 I	CATO-PARK m	UP-ANNEX r	Y s	Y t	PERIODICAL u	4/15/2013 z	4646
949	a	QH505.P47 v.56 no.17-18 2011 w	LCPER c	1 i	000059355168 I	CATO-PARK m	UP-ANNEX r	Y s	Y t	PERIODICAL u	4/15/2013 z	4646
949	a	QH505.P47 v.56 no.15-16 2011 w	LCPER c	1 i	000059334965 I	CATO-PARK m	UP-ANNEX r	Y s	Y t	PERIODICAL u	4/15/2013 z	4646
949	a	QH505.P47 v.56 no.19-21 2011 w	LCPER c	1 i	000059343769 I	CATO-PARK m	UP-ANNEX r	Y s	Y t	PERIODICAL u	4/15/2013 z	4646
949	a	QH505.P47 v.56 no.10-12 2011 w	LCPER c	1 i	000059346067 I	CATO-PARK m	UP-ANNEX r	Y s	Y t	PERIODICAL u	4/15/2013 z	4646
949	a	QH505.P47 v.56 no.7-9 2011 w	LCPER c	1 i	000059358763 I	CATO-PARK m	UP-ANNEX r	Y s	Y t	PERIODICAL u	4/15/2013 z	4646
949	a	QH505.P47 v.57 no.16-18 2012 w	LCPER c	1 i	000059355717 I	CATO-PARK m	UP-ANNEX r	Y s	Y t	PERIODICAL u	5/9/2013 z	4646
949	a	QH505.P47 v.57 no.19-21 2012 w	LCPER c	1 i	000059333753 I	CATO-PARK m	UP-ANNEX r	Y s	Y t	PERIODICAL u	5/9/2013 z	4646
949	a	QH505.P47 v.57 no.22-23 2012 w	LCPER c	1 i	000059719663 I	CATO-PARK m	UP-ANNEX r	Y s	Y t	PERIODICAL u	5/9/2013 z	4646
949	a	QH505.P47 v.57 no.10-12 2012 w	LCPER c	1 i	000059336327 I	CATO-PARK m	UP-ANNEX r	Y s	Y t	PERIODICAL u	5/9/2013 z	4646
949	a	QH505.P47 v.57 no.13-15 2012 w	LCPER c	1 i	000059338314 I	CATO-PARK m	UP-ANNEX r	Y s	Y t	PERIODICAL u	5/9/2013 z	4646
949	a	QH505.P47 v.57 no.4-6 2012 w	LCPER c	1 i	000059334156 I	CATO-PARK m	UP-ANNEX r	Y s	Y t	PERIODICAL u	5/9/2013 z	4646
949	a	QH505.P47 v.57 no.1-3 2012 w	LCPER c	1 i	000059337775 I	CATO-PARK m	UP-ANNEX r	Y s	Y t	PERIODICAL u	5/9/2013 z	4646
949	a	QH505.P47 v.57 no.7-9 2012 w	LCPER c	1 i	000059357575 I	CATO-PARK m	UP-ANNEX r	Y s	Y t	PERIODICAL u	5/9/2013 z	4646
949	a	QH505.P47 v.3-4 1958-60 w	LCPER c	1 i	000073470984 I	PATERNO-4 m	UP-PAT r	Y s	Y t	PERIODICAL u	1/30/2014	
949	a	QH505.P47 v.5-6 1960-62 w	LCPER c	1 i	000073470991 I	PATERNO-4 m	UP-PAT r	Y s	Y t	PERIODICAL u	1/30/2014	
949	a	QH505.P47 v.7-8 1962/63 w	LCPER c	1 i	000073471004 I	PATERNO-4 m	UP-PAT r	Y s	Y t	PERIODICAL u	1/30/2014	
949	a	QH505.P47 v.9-10 1964/65 w	LCPER c	1 i	000073471097 I	PATERNO-4 m	UP-PAT r	Y s	Y t	PERIODICAL u	1/30/2014	
949	a	QH505.P47 v.11 1966 w	LCPER c	1 i	000073471080 I	PATERNO-4 m	UP-PAT r	Y s	Y t	PERIODICAL u	1/30/2014	
949	a	QH505.P47 v.12 1967 w	LCPER c	1 i	000073471073 I	PATERNO-4 m	UP-PAT r	Y s	Y t	PERIODICAL u	1/30/2014	
949	a	QH505.P47 v.13 1968 w	LCPER c	1 i	000073471066 I	PATERNO-4 m	UP-PAT r	Y s	Y t	PERIODICAL u	1/30/2014	
949	a	QH505.P47 v.14 1969 w	LCPER c	1 i	000073471059 I	PATERNO-4 m	UP-PAT r	Y s	Y t	PERIODICAL u	1/30/2014	
949	a	QH505.P47 v.15 1970 w	LCPER c	1 i	000073471042 I	PATERNO-4 m	UP-PAT r	Y s	Y t	PERIODICAL u	1/30/2014	
949	a	QH505.P47 v.16 1971 w	LCPER c	1 i	000073471035 I	PATERNO-4 m	UP-PAT r	Y s	Y t	PERIODICAL u	1/30/2014	
949	a	QH505.P47 v.17 1972 w	LCPER c	1 i	000073471028 I	PATERNO-4 m	UP-PAT r	Y s	Y t	PERIODICAL u	1/30/2014	
949	a	QH505.P47 v.18 1973 w	LCPER c	1 i	000073471011 I	PATERNO-4 m	UP-PAT r	Y s	Y t	PERIODICAL u	1/30/2014	
949	a	QH505.P47 v.19 no.1-3 1974 w	LCPER c	1 i	000073471189 I	PATERNO-4 m	UP-PAT r	Y s	Y t	PERIODICAL u	1/30/2014	
949	a	QH505.P47 v.19 no.4-6 1974 w	LCPER c	1 i	000073471172 I	PATERNO-4 m	UP-PAT r	Y s	Y t	PERIODICAL u	1/30/2014	
949	a	QH505.P47 v.20 no.4-6 1975 w	LCPER c	1 i	000073471158 I	PATERNO-4 m	UP-PAT r	Y s	Y t	PERIODICAL u	1/30/2014	
949	a	QH505.P47 v.20 no.1-3 1975 w	LCPER c	1 i	000073471165 I	PATERNO-4 m	UP-PAT r	Y s	Y t	PERIODICAL u	1/30/2014	
949	a	QH505.P47 v.21 no.1-3 1976 w	LCPER c	1 i	000073471141 I	PATERNO-4 m	UP-PAT r	Y s	Y t	PERIODICAL u	1/30/2014	
949	a	QH505.P47 v.21 no.4-6 1976 w	LCPER c	1 i	000073471134 I	PATERNO-4 m	UP-PAT r	Y s	Y t	PERIODICAL u	1/30/2014	
949	a	QH505.P47 v.22 no.4-6 1977 w	LCPER c	1 i	000073471110 I	PATERNO-4 m	UP-PAT r	Y s	Y t	PERIODICAL u	1/30/2014	
949	a	QH505.P47 v.22 no.1-3 1977 w	LCPER c	1 i	000073471127 I	PATERNO-4 m	UP-PAT r	Y s	Y t	PERIODICAL u	1/30/2014	
949	a	QH505.P47 v.23 no.1-3 1978 w	LCPER c	1 i	000073471103 I	PATERNO-4 m	UP-PAT r	Y s	Y t	PERIODICAL u	1/30/2014	
949	a	QH505.P47 v.23 no.4-6 1978 w	LCPER c	1 i	000073471196 I	PATERNO-4 m	UP-PAT r	Y s	Y t	PERIODICAL u	1/30/2014	

866	U	8	U	a	v.49(2004)-v.57(2012)
852	8	1	a	PSt b	UP-ANNEX c ANNEX h Periodical
866	0	8	0	a	v.41(1996)-v.44(1999)
852	0		a	PSt b	UP-PAT c PATERNO-4 h QH505 i .P47
866	0	8	0	a	v.1(1956)-v.40(1995)
852	0	1	a	PSt b	UP-PAMS c BDJNL-PM h QH505 i .P47
866	0	8	0	a	v.48(2003),Current unbound issues



Copyright ©2019 The Pennsylvania State University. All rights reserved. Except where otherwise noted, this work is subject to a Creative Commons Attribution 4.0 license. Details and exceptions.

[Legal Statements](#) | [PSU Hotlines](#)

PENN STATE UNIVERSITY LIBRARIES

- [Libraries Home](#) (814) 865-6368
- [Libraries Intranet \(Staff Only\)](#)
- [Accessibility Help](#)
- [Website Feedback](#)
- [Policies and Guidelines](#)
- [Staff Directory](#)

CONNECT WITH PENN STATE UNIVERSITY LIBRARIES

- [Facebook](#)
- [Twitter](#)
- [Instagram](#)

🔍 Covid 19 updates and more information about using the Libraries while you're remote.



Catalog

Bookmarks 0 Course Reserves My Account

Keyword Search...

Search

Advanced search Start Over

Share Bookmark Report an Issue



Physics in medicine & biology

Additional Titles: Physics in medicine and biology
Published: London : Hospital Physicists Association, 1956-
Physical Description: volumes : illustrations ; 26 cm
Additional Creators: Hospital Physicists' Association, Canadian Association of Physicists, Medical and Biological Physics Division, International Organization for Medical Physics, American Institute of Physics, Deutsche Gesellschaft für Medizinische Physik, and American Association of Physicists in Medicine



Search inside at HathiTrust

Availability

I Want It

Pattee Library and Paterno Library Stacks (70 items)

Call number	Material	Location
QH505.P47 v.40 no.10-12 1995	Bound Journal	Paterno - 4th Floor
QH505.P47 v.40 no.7-9 1995	Bound Journal	Paterno - 4th Floor
QH505.P47 v.40 no.4-6 1995	Bound Journal	Paterno - 4th Floor
QH505.P47 v.40 no.1-3 1995	Bound Journal	Paterno - 4th Floor
QH505.P47 v.39 no.10-12 1994	Bound Journal	Paterno - 4th Floor
QH505.P47 v.39 no.7-9 1994	Bound Journal	Paterno - 4th Floor
QH505.P47 v.39 no.4-6 1994	Bound Journal	Paterno - 4th Floor
QH505.P47 v.39 no.1-3 1994	Bound Journal	Paterno - 4th Floor
QH505.P47 v.38 no.10-12 1993	Bound Journal	Paterno - 4th Floor
QH505.P47 v.38 no.7-9 1993	Bound Journal	Paterno - 4th Floor
QH505.P47 v.38 no.4-6 1993	Bound Journal	Paterno - 4th Floor
QH505.P47 v.38 no.1-3 1993	Bound Journal	Paterno - 4th Floor
QH505.P47 v.37 no.10-12 1992	Bound Journal	Paterno - 4th Floor
QH505.P47 v.37 no.7-9 1992	Bound Journal	Paterno - 4th Floor
QH505.P47 v.37 no.4-6 1992	Bound Journal	Paterno - 4th Floor
QH505.P47 v.37 no.1-3 1992	Bound Journal	Paterno - 4th Floor
QH505.P47 v.36 no.10-12 1991	Bound Journal	Paterno - 4th Floor
QH505.P47 v.36 no.7-9 1991	Bound Journal	Paterno - 4th Floor
QH505.P47 v.36 no.4-6 1991	Bound Journal	Paterno - 4th Floor
QH505.P47 v.36 no.1-3 1991	Bound Journal	Paterno - 4th Floor
QH505.P47 v.35 no.10-12 1990	Bound Journal	Paterno - 4th Floor
QH505.P47 v.35 no.7-9 1990	Bound Journal	Paterno - 4th Floor
QH505.P47 v.35 no.4-6 1990	Bound Journal	Paterno - 4th Floor

QH505.P47 v.35 no.1-3 1990	Bound Journal	Paterno - 4th Floor
QH505.P47 v.34 no.10-12 1989	Bound Journal	Paterno - 4th Floor
QH505.P47 v.34 no.7-9 1989	Bound Journal	Paterno - 4th Floor
QH505.P47 v.34 no.1-6 1989	Bound Journal	Paterno - 4th Floor
QH505.P47 v.33 no.7-12 1988	Bound Journal	Paterno - 4th Floor
QH505.P47 v.33 no.1-6 1988	Bound Journal	Paterno - 4th Floor
QH505.P47 v.32 no.7-12 1987	Bound Journal	Paterno - 4th Floor
QH505.P47 v.32 no.1-6 1987	Bound Journal	Paterno - 4th Floor
QH505.P47 v.31 no.7-12 1986	Bound Journal	Paterno - 4th Floor
QH505.P47 v.31 no.1-6 1986	Bound Journal	Paterno - 4th Floor
QH505.P47 v.30 no.7-12 1985	Bound Journal	Paterno - 4th Floor
QH505.P47 v.30 no.1-6 1985	Bound Journal	Paterno - 4th Floor
QH505.P47 v.29 no.7-12 1984	Bound Journal	Paterno - 4th Floor
QH505.P47 v.29 no.1-6 1984	Bound Journal	Paterno - 4th Floor
QH505.P47 v.28 no.7-12 1983	Bound Journal	Paterno - 4th Floor
QH505.P47 v.28 no.1-6 1983	Bound Journal	Paterno - 4th Floor
QH505.P47 v.27 no.6-12 1982	Bound Journal	Paterno - 4th Floor
QH505.P47 v.27 no.1-5 1982	Bound Journal	Paterno - 4th Floor
QH505.P47 v.26 no.4-6 1981	Bound Journal	Paterno - 4th Floor
QH505.P47 v.26 no.1-3 1981	Bound Journal	Paterno - 4th Floor
QH505.P47 v.25 no.4-6 1980	Bound Journal	Paterno - 4th Floor
QH505.P47 v.25 no.1-3 1980	Bound Journal	Paterno - 4th Floor
QH505.P47 v.24 no.4-6 1979	Bound Journal	Paterno - 4th Floor
QH505.P47 v.24 no.1-3 1979	Bound Journal	Paterno - 4th Floor
QH505.P47 v.23 no.4-6 1978	Bound Journal	Paterno - 4th Floor
QH505.P47 v.23 no.1-3 1978	Bound Journal	Paterno - 4th Floor
QH505.P47 v.22 no.4-6 1977	Bound Journal	Paterno - 4th Floor
QH505.P47 v.22 no.1-3 1977	Bound Journal	Paterno - 4th Floor
QH505.P47 v.21 no.4-6 1976	Bound Journal	Paterno - 4th Floor
QH505.P47 v.21 no.1-3 1976	Bound Journal	Paterno - 4th Floor
QH505.P47 v.20 no.4-6 1975	Bound Journal	Paterno - 4th Floor
QH505.P47 v.20 no.1-3 1975	Bound Journal	Paterno - 4th Floor
QH505.P47 v.19 no.4-6 1974	Bound Journal	Paterno - 4th Floor
QH505.P47 v.19 no.1-3 1974	Bound Journal	Paterno - 4th Floor
QH505.P47 v.18 1973	Bound Journal	Paterno - 4th Floor
QH505.P47 v.17 1972	Bound Journal	Paterno - 4th Floor
QH505.P47 v.16 1971	Bound Journal	Paterno - 4th Floor
QH505.P47 v.15 1970	Bound Journal	Paterno - 4th Floor
QH505.P47 v.14 1969	Bound Journal	Paterno - 4th Floor
QH505.P47 v.13 1968	Bound Journal	Paterno - 4th Floor
QH505.P47 v.12 1967	Bound Journal	Paterno - 4th Floor
QH505.P47 v.11 1966	Bound Journal	Paterno - 4th Floor
QH505.P47 v.9-10 1964/65	Bound Journal	Paterno - 4th Floor
QH505.P47 v.7-8 1962/63	Bound Journal	Paterno - 4th Floor
QH505.P47 v.5-6 1960-62	Bound Journal	Paterno - 4th Floor
QH505.P47 v.3-4 1958-60	Bound Journal	Paterno - 4th Floor
QH505.P47 v.1-2 1956-58	Bound Journal	Paterno - 4th Floor

Periodical 1997 42JL-DE	Bound Journal	Use I Want It to request annexed material
Periodical 1997 42 JA-JN	Bound Journal	Use I Want It to request annexed material
Periodical 1996 41 OC-DE	Bound Journal	Use I Want It to request annexed material
Periodical 1996 41 JL-SE	Bound Journal	Use I Want It to request annexed material
Periodical 1996 41 JA-JN	Bound Journal	Use I Want It to request annexed material

[View Less](#)

Physical & Mathematical Sciences Library (UP) (8 items)

Call number	Material	Location
QH505.P47 v.48 no.22-24 2003	Bound Journal	Phys. & Math. Sci., 201 Davey Lab - Bound Journal Collection
QH505.P47 v.48 no.19-21 p3101-3624 2003	Bound Journal	Phys. & Math. Sci., 201 Davey Lab - Bound Journal Collection
QH505.P47 v.48 no.16-18 p2577-3100 2003	Bound Journal	Phys. & Math. Sci., 201 Davey Lab - Bound Journal Collection
QH505.P47 v.48 no.13-15 p1863-2576 2003	Bound Journal	Phys. & Math. Sci., 201 Davey Lab - Bound Journal Collection
QH505.P47 v.48 no.10-12 p1239-1862 2003	Bound Journal	Phys. & Math. Sci., 201 Davey Lab - General Collection
QH505.P47 v.48 no.7-9 p.805-1238 2003	Bound Journal	Phys. & Math. Sci., 201 Davey Lab - General Collection
QH505.P47 v.48 no.4-6 p.417-804 2003	Bound Journal	Phys. & Math. Sci., 201 Davey Lab - General Collection
QH505.P47 v.48 no.1-3 p.1-416 2003	Bound Journal	Phys. & Math. Sci., 201 Davey Lab - General Collection

[View Less](#)

Language Note:

Texts and summaries in English, French, or German.

Dates of Publication and/or Sequential Designation:

v.1- July 1956-

Subject(s):

- [Biophysics—Periodicals](#)
- [Medical physics—Periodicals](#)
- [Biology](#)
- [General Medicine](#)
- [Physics—periodicals](#)

ISSN:

0031-9155

Publication Frequency:

Semimonthly, 2002- and Frequency varies, 1956-2001

Issuing Body:

"Journal of the Hospital Physicists' Association." and Official journal of the Hospital Physicists' Association, 1956- ; the American Association of Physicists in Medicine, 1964-1973; the Medical and Biological Physics Division, Canadian Association of Physicists, 1965- ; the International Organization for Medical Physics, 1970- ; and the Deutsche Gesellschaft für Medizinische Physik, 1982?-

[View MARC record](#) | catkey: 1296394



Copyright ©2019 The Pennsylvania State University. All rights reserved. Except where otherwise noted, this work is subject to a Creative Commons Attribution 4.0 license. Details and exceptions.

[Legal Statements](#) | [PSU Hotlines](#)

PENN STATE UNIVERSITY LIBRARIES

[Libraries Home](#) (814) 865-6368

[Libraries Intranet \(Staff Only\)](#)

[Accessibility Help](#)

[Website Feedback](#)

[Policies and Guidelines](#)

[Staff Directory](#)

CONNECT WITH PENN STATE UNIVERSITY LIBRARIES

[Facebook](#)

[Twitter](#)

[Instagram](#)

HECHT01



OPTICS

HECHT

PHYS
QC355.2
H42
1990



OPTICS

SECOND EDITION

EUGENE HECHT
Adelphi University

PHYS
QC355.2
H42
1990

With Contributions by Alfred Zajac



ADDISON-WESLEY PUBLISHING COMPANY
Reading, Massachusetts ■ Menlo Park, California ■ Don Mills, Ontario
Wokingham, England ■ Amsterdam ■ Sydney ■ Singapore
Tokyo ■ Madrid ■ Bogotá ■ Santiago ■ San Juan

Sponsoring editor: Bruce Spatz
Production supervisors: Margaret Pinette and Lorraine Ferrier
Text designer: Joyce Weston
Illustrators: Oxford Illustrators
Art consultant: Loretta Bailey
Manufacturing supervisor: Ann DeLacey

Library of Congress Cataloging-in-Publication Data

Hecht, Eugene.
Optics.

Bibliography: p.
Includes indexes.

1. Optics. I. Zajac, Alfred. II. Title.

QC355.2.H42 1987 535 86-14067

ISBN 0-201-11609-X

Reprinted with corrections May, 1990.

Copyright © 1987, 1974 by Addison-Wesley Publishing Company, Inc.

All rights reserved. No part of this publication may be reproduced, stored in a retrieval system, or transmitted, in any form or by any means, electronic, mechanical, photocopying, recording, or otherwise, without the prior written permission of the publisher.

Printed in the United States of America. Published simultaneously in Canada.

8 9 10 HA 9594939291

Contents





1 A Brief History	1	4.2 The Laws of Reflection and Refraction	79
1.1 Prolegomenon	1	4.3 The Electromagnetic Approach	92
1.2 In the Beginning	1	4.4 Familiar Aspects of the Interaction of Light and Matter	114
1.3 From the Seventeenth Century	2	4.5 The Stokes Treatment of Reflection and Refraction	118
1.4 The Nineteenth Century	5	4.6 Photons and the Laws of Reflection and Refraction	120
1.5 Twentieth-Century Optics	8	Problems	121
2 The Mathematics of Wave Motion	12	5 Geometrical Optics—Paraxial Theory	128
2.1 One-Dimensional Waves	12	5.1 Introductory Remarks	128
2.2 Harmonic Waves	15	5.2 Lenses	129
2.3 Phase and Phase Velocity	17	5.3 Stops	149
2.4 The Complex Representation	19	5.4 Mirrors	153
2.5 Plane Waves	21	5.5 Prisms	163
2.6 The Three-Dimensional Differential Wave Equation	23	5.6 Fiberoptics	170
2.7 Spherical Waves	24	5.7 Optical Systems	176
2.8 Cylindrical Waves	27	Problems	202
2.9 Scalar and Vector Waves	28	6 More on Geometrical Optics	211
Problems	30	6.1 Thick Lenses and Lens Systems	211
3 Electromagnetic Theory, Photons, and Light	33	6.2 Analytical Ray Tracing	215
3.1 Basic Laws of Electromagnetic Theory	34	6.3 Aberrations	220
3.2 Electromagnetic Waves	39	Problems	240
3.3 Energy and Momentum	43	7 The Superposition of Waves	242
3.4 Radiation	47	<i>The Addition of Waves of the Same Frequency</i>	243
3.5 Light and Matter	56	7.1 The Algebraic Method	243
3.6 The Electromagnetic-Photon Spectrum	68	7.2 The Complex Method	246
Problems	75		
4 The Propagation of Light	79		
4.1 Introduction	79		

x Contents

7.3 Phasor Addition	247	11 Fourier Optics	472
7.4 Standing Waves	248	11.1 Introduction	472
<i>The Addition of Waves of Different Frequency</i>	250	11.2 Fourier Transforms	472
7.5 Beats	250	11.3 Optical Applications	483
7.6 Group Velocity	252	Problems	512
7.7 Anharmonic Periodic Waves—Fourier Analysis	254	12 Basics of Coherence Theory	516
7.8 Nonperiodic Waves—Fourier Integrals	259	12.1 Introduction	516
7.9 Pulses and Wave Packets	261	12.2 Visibility	519
7.10 Optical Bandwidths	263	12.3 The Mutual Coherence Theory and the Degree of Coherence	523
Problems	266	12.4 Coherence and Stellar Interferometry	530
8 Polarization	270	Problems	535
8.1 The Nature of Polarized Light	270	13 Some Aspects of the Quantum Nature of Light	538
8.2 Polarizers	277	13.1 Quantum Fields	538
8.3 Dichroism	279	13.2 Blackbody Radiation—Planck's Quantum Hypothesis	539
8.4 Birefringence	282	13.3 The Photoelectric Effect—Einstein's Photon Concept	541
8.5 Scattering and Polarization	292	13.4 Particles and Waves	544
8.6 Polarization by Reflection	296	13.5 Probability and Wave Optics	548
8.7 Retarders	300	13.6 Fermat, Feynman, and Photons	550
8.8 Circular Polarizers	305	13.7 Absorption, Emission, and Scattering	552
8.9 Polarization of Polychromatic Light	306	Problems	556
8.10 Optical Activity	309	14 Sundry Topics from Contemporary Optics	559
8.11 Induced Optical Effects—Optical Modulators	314	14.1 Imagery—The Spatial Distribution of Optical Information	559
8.12 A Mathematical Description of Polarization . .	321	14.2 Lasers and Laserlight	577
Problems	326	14.3 Holography	593
9 Interference	333	14.4 Nonlinear Optics	610
9.1 General Considerations	334	Problems	616
9.2 Conditions for Interference	337	Appendix 1	620
9.3 Wavefront-Splitting Interferometers	339	Appendix 2	623
9.4 Amplitude-Splitting Interferometers	346	Table 1	624
9.5 Types and Localization of Interference Fringes	361	Solutions to Selected Problems	629
9.6 Multiple-Beam Interference	363	Bibliography	661
9.7 Applications of Single and Multilayer Films . .	373	Index of Tables	665
9.8 Applications of Interferometry	378	Index	667
Problems	388		
10 Diffraction	392		
10.1 Preliminary Considerations	392		
10.2 Fraunhofer Diffraction	401		
10.3 Fresnel Diffraction	434		
10.4 Kirchhoff's Scalar Diffraction Theory	459		
10.5 Boundary Diffraction Waves	463		
Problems	465		

QC 355.2

N42
1990

DATE DUE		
		
		AUG 31 2018
	JAN 1 2010	
	Feb 28 2010	
	MAY 1 1 2010	
	AUG 1 7 2010	
	JAN 1 2 2011	
	MAR 1 6 2011	
GAYLORD		PRINTED IN U.S.A.

Requested For : MUNFORD, JACOB



Resource Request Slip Letter

08/18/2021

Request ID:



11492811380006236

Requested For: MUNFORD, JACOB
(2L000200041074U)

Optics /
By: Hecht, Eugene.

ISBN: 020111609X

Edition: 2nd ed., repr. with corrections.

Imprint: Reading, Mass. : Addison-Wesley, 1990,
c1987.

Location: General Collection

**Call Number: QC355.2 .H42
1990**

Destination: Hillman Library

Request Type: Patron physical item request

Request Note: No-Contact Pickup ★

Science and Engineering Library (Benedum Hall)

HECHT02

```
leader 00757cam a2200265Ia 4500
001 9939241863406236
005 20180726202712.0
008 940303t19901987maua b 001 0 eng d
035 ##$a(OCOLC)ocm29902761
035 ##$a3924186
035 ##$a(ppiu)3924186-pittdb
035 ##$a(pittdb)3924186-pittdb
040 ##$aOLC $cOLC $dPBR $dWaOLN
020 ##$a020111609X
090 ##$aQC355.2 $b.H42 1990
092 ##$a535 $bH447o
049 ##$aPITT
100 1#$aHecht, Eugene.
245 10$aOptics / $cEugene Hecht ; with contributions by Alfred Zajac.
250 ##$a2nd ed., repr. with corrections.
260 ##$aReading, Mass. : $bAddision-Wesley, $c1990, c1987.
300 ##$ax, 676 p. : $bill. ; $c25 cm.
504 ##$aBibliography: p. 661-664.
500 ##$aIncludes indexes.
650 #0$aOptics.
700 1#$aZajac, Alfred.
994 ##$aE0 $bPIT
906 ##$aULS
```



University of Pittsburgh

PittCat

NEW SEARCH
BROWSE
JOURNAL FINDER
DATABASE FINDER

Sign in
Menu

Books, Articles, and More

[ADVANCED SEARCH](#)

MULTIPLE VERSIONS

Optics

Hecht, Eugene.; Zajac, Alfred.

Not Available >

Report a Problem

5 versions found. See all versions >

TOP

SEND TO

GET IT

DETAILS

VIRTUAL BROW...

LINKS

EXPLORE

Send to

CITATION

EMAIL

ENDNOTE/ZOTERI

PRINT

PERMALINK

Get It

Please sign in to check if there are any request options. [Sign in](#)

< BACK TO LOCATIONS

LOCATION ITEMS

Science and Engineering Library (Benedum Hall)

Out of library , General Collection QC355.2 .H42 1990

(1 copy, 0 available, 1 request)

In transit until 08/19/2021
 Loanable

Details

Title	Optics
Creator	Hecht, Eugene. >
Contributor	Zajac, Alfred. >
Language	English
Edition	2nd ed., repr. with corrections.
Publisher	Reading, Mass. : Addison-Wesley
Date	1990, c1987
Type	Book
Description	x, 676 p. : ill. ; 25 cm.
Notes	Includes indexes. Bibliography: p. 661-664.
Subject	Optics >
Identifier	OCLC : (OCoLC)ocm29902761 ISBN : 020111609X
Source	Library Catalog

Virtual Browse

Optics
1990, c1987

Laboratory activities with light : designed for students of ...
c1959

Light & color
c2005

Répertoire d'optique moderne, ou analyse complète ...
1847-50

Links

Find this item in Google Books >

Display Source Record >

Syndetics Unbound

Related reading

Recommended items that are related to the record

Mathematical methods for

Arfken, George B.

ISBN 9780123846549

suggested by

Principles of optics : electromagnetic

Born, Max

ISBN 9781483103204

suggested by

Building Electro-Optical Systems :

Hobbs, Philip C. D.

ISBN 9780470402290

suggested by

Introduction to quantum mechanics

Griffiths, David J.

ISBN 9781107189638

suggested by

Light : Stop Faking It! Finally

Robertson, William C.

ISBN 9780873552158

suggested by

More

64

Summary
Also Available As

Look Inside
Tags

Reader Reviews
Browse Shelf

SUMMARY

A comprehensive study of the field of optics.

LOOK INSIDE

- 1. A Brief History
- 2. Wave Motion
- 3. Electromagnetic Theory, Photons, and Light

[SEE FULL TABLE OF CONTENTS](#) [COVER](#)

READER REVIEWS

★ ★ ½ ★ ★ Reviewed by 3 people

What do you think? Write your own review

I had a course on Optics in my first year in University with this book. The book has lots of examples and is very "wordy". I suspect the author hoped to make it a reference as well as a study book. The number of photos in "Optics" is unusually high for a Physics book. I wouldn't mind if some of those were colour photos, but then again it would have made the book less affordable. Topics [\(read more\)](#)

I loathed this book when I was an undergraduate student, more so than any textbook I've ever encountered before or since. And what do you know? Reading it again, sixteen years later, I loathe it just as much. This was the book that instilled in me a hatred of everything and anything to do with optics, a hatred that persists to this day. It is the very fact that I hate optics so much that [\(read more\)](#)

Review by IvanIldris (LibraryThing)

★ ★ ★ ★ ★

Review by name99 (LibraryThing) ½ ★ ★ ★ ★ ★

[SEE MORE REVIEWS](#)

ALSO AVAILABLE AS

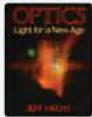

Paper Book

TAGS

light	applied physics	engineering	
reference	physics	university	
optics	james	science	
interference	waves	photonics	technical
	lasers	Hecht	office

[BROWSE TAGS](#)

BROWSE SHELF

QC353 .W7725216 1994

QC355.2 .Y46 2018

[SEE FULL SHELF](#)

HECHT03



OPTICS

FOURTH EDITION

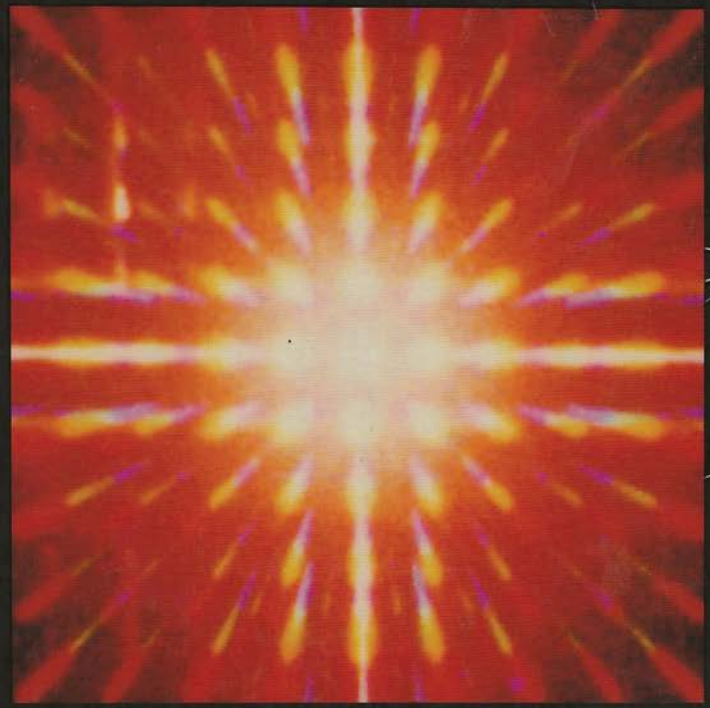

Eugene Hecht

Hecht

OPTICS

FOURTH
EDITION

HILL
QC355.3
H43
2002



Optics has been the leading text for a decade. Written in a lively, accessible style, it is known for its accurate and authoritative nature, comprehensive scope, and outstanding visual pedagogy. In this Fourth Edition, *Optics* has been brought up-to-date with new illustrations, photos, and updates on the latest advances in the field. Throughout, this text provides a careful balance of theory and instrumentation, while also giving you all the necessary classical background. Complete solutions to many problems are included at the back of the text providing an invaluable study aid.

What professors are saying about *Optics*, Fourth Edition:

“Hecht is still the best text for a junior level course [in optics].”
—Robert A. Luke, Boise State University

“I have always admired this text. It is a real tour de force.”
—Edward Whittaker, Stevens Institute of Technology

“Since I try to emphasize the physical meanings of optical phenomena, not just calculations, Hecht’s book is an excellent choice for me.”
—Wei-Chih Liu, National Taiwan Normal University

Please visit us at www.aw.com/physics for more information. To order any of our products, contact our customer service department at (800) 824-7799, (201) 767-5021 outside of the U.S., or visit your campus bookstore.

Pearson
Education



UNIVERSITY OF PITTSBURGH LIBRARIES

4^{ed} OPTICS

Eugene Hecht
Adelphi University

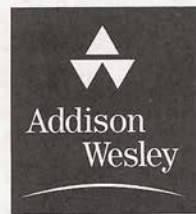

San Francisco Boston New York
Capetown Hong Kong London Madrid Mexico City
Montreal Munich Paris Singapore Sydney Tokyo Toronto

Sponsoring Editor: *Adam Black*
Project Manager: *Nancy Gee*
Manufacturing Supervisor: *Vivian McDougal*
Cover Designer: *Blakeley Kim*
Production Service: **HRS Interactive**
Text Design: **HRS Interactive**
Composition: **HRS Interactive**
Illustration: **HRS Interactive**
Photo Research: *Carolyn Eisen Hecht*

Library of Congress Cataloging-in-Publication Data

Hecht, Eugene
Optics / Eugene Hecht; — 4th ed.
p. cm.
Includes bibliographical references and index.
ISBN 0-8053-8566-5
1. Optics. I. Title.
QC355.3.H43 2002
535—dc21

2001032540

Copyright ©2002 Pearson Education, Inc., publishing as Addison Wesley, 1301 Sansome St., San Francisco, CA 94111. All rights reserved. Manufactured in the United States of America. This publication is protected by Copyright and permission should be obtained from the publisher prior to any prohibited reproduction, storage in a retrieval system, or transmission in any form or by any means, electronic, mechanical, photocopying, recording, or likewise. To obtain permission(s) to use material from this work, please submit a written request to Pearson Education, Inc., Permissions Department, 1900 E. Lake Ave., Glenview, IL 60025. For information regarding permissions, call 847/486/2635.

Many of the designations used by manufacturers and sellers to distinguish their products are claimed as trademarks. Where those designations appear in this book, and the publisher was aware of a trademark claim, the designations have been printed in initial caps or all caps.

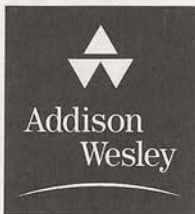

3 4 5 6 7 8 9 10-MA-04 03 02
www.aw.com/physics

Content

1 A Brief History 1

- 1.1 Prolegomenon 1
- 1.2 In the Beginning 1
- 1.3 From the Seventeenth Century 2
- 1.4 The Nineteenth Century 4
- 1.5 Twentieth-Century Optics 7

2 Wave Motion 10

- 2.1 One-Dimensional Waves 10
- 2.2 Harmonic Waves 14
- 2.3 Phase and Phase Velocity 17
- 2.4 The Superposition Principle 20
- 2.5 The Complex Representation 21
- 2.6 Phasors and the Addition of Waves 23
- 2.7 Plane Waves 24
- 2.8 The Three-Dimensional Differential Wave Equation 27
- 2.9 Spherical Waves 28
- 2.10 Cylindrical Waves 31
- Problems 32

3 Electromagnetic Theory, Photons, and Light 36

- 3.1 Basic Laws of Electromagnetic Theory 37
- 3.2 Electromagnetic Waves 44
- 3.3 Energy and Momentum 47
- 3.4 Radiation 58
- 3.5 Light in Bulk Matter 66
- 3.6 The Electromagnetic-Photon Spectrum 73
- 3.7 Quantum Field Theory 80
- Problems 82

4 The Propagation of Light 86

- 4.1 Introduction 86

- 4.2 Rayleigh Scattering 86
- 4.3 Reflection 95
- 4.4 Refraction 100
- 4.5 Fermat's Principle 106
- 4.6 The Electromagnetic Approach 111
- 4.7 Total Internal Reflection 122
- 4.8 Optical Properties of Metals 127
- 4.9 Familiar Aspects of the Interaction of Light and Matter 131
- 4.10 The Stokes Treatment of Reflection and Refraction 136
- 4.11 Photons, Waves, and Probability 137
- Problems 141

5 Geometrical Optics 149

- 5.1 Introductory Remarks 149
- 5.2 Lenses 150
- 5.3 Stops 171
- 5.4 Mirrors 175
- 5.5 Prisms 186
- 5.6 Fiberoptics 193
- 5.7 Optical Systems 201
- 5.8 Wavefront Shaping 226
- 5.9 Gravitational Lensing 231
- Problems 234

6 More on Geometrical Optics 243

- 6.1 Thick Lenses and Lens Systems 243
- 6.2 Analytical Ray Tracing 246
- 6.3 Aberrations 253
- 6.4 GRIN Systems 273
- 6.5 Concluding Remarks 276
- Problems 277

7 The Superposition of Waves 281

- 7.1 The Addition of Waves of the Same Frequency 282
- 7.2 The Addition of Waves of Different Frequency 294
- 7.3 Anharmonic Periodic Waves 302
- 7.4 Nonperiodic Waves 308
Problems 320

8 Polarization 325

- 8.1 The Nature of Polarized Light 325
- 8.2 Polarizers 331
- 8.3 Dichroism 333
- 8.4 Birefringence 336
- 8.5 Scattering and Polarization 344
- 8.6 Polarization by Reflection 348
- 8.7 Retarders 352
- 8.8 Circular Polarizers 357
- 8.9 Polarization of Polychromatic Light 358
- 8.10 Optical Activity 360
- 8.11 Induced Optical Effects—Optical Modulators 365
- 8.12 Liquid Crystals 370
- 8.13 A Mathematical Description of Polarization 372
Problems 379

9 Interference 385

- 9.1 General Considerations 386
- 9.2 Conditions for Interference 390
- 9.3 Wavefront-splitting Interferometers 393
- 9.4 Amplitude-splitting Interferometers 400
- 9.5 Types and Localization of Interference Fringes 414
- 9.6 Multiple-Beam Interference 416
- 9.7 Applications of Single and Multilayer Films 425
- 9.8 Applications of Interferometry 431
Problems 438

10 Diffraction 443

- 10.1 Preliminary Considerations 443
- 10.2 Fraunhofer Diffraction 452
- 10.3 Fresnel Diffraction 485
- 10.4 Kirchhoff's Scalar Diffraction Theory 510
- 10.5 Boundary Diffraction Waves 512
Problems 514

11 Fourier Optics 519

- 11.1 Introduction 519
- 11.2 Fourier Transforms 519
- 11.3 Optical Applications 529
Problems 556

12 Basics of Coherence Theory 560

- 12.1 Introduction 560
- 12.2 Visibility 562
- 12.3 The Mutual Coherence Function and the Degree of Coherence 566
- 12.4 Coherence and Stellar Interferometry 573
Problems 578

13 Modern Optics: Lasers and Other Topics 581

- 13.1 Lasers and Laserlight 581
- 13.2 Imagery — The Spatial Distribution of Optical Information 606
- 13.3 Holography 623
- 13.4 Nonlinear Optics 639
Problems 644

Appendix 1 649**Appendix 2 652****Table 1 653****Solutions to Selected Problems 658****Bibliography 685****Index 689**

Requested For : MUNFORD, JACOB



Resource Request Slip Letter

08/18/2021

Request ID:

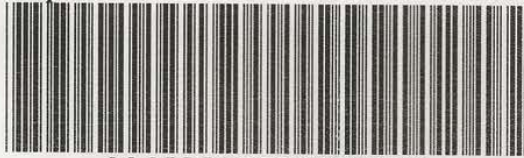

11492813820006236

Requested For: MUNFORD, JACOB
(2L000200041074U)

Optics /
By: Hecht, Eugene.

ISBN: 0805385665

Edition: 4th ed.

Imprint: Reading, Mass. : Addison-Wesley, c2002.

Location: General Collection 2

**Call Number: QC355.3 .H43
2002**

Destination: Hillman Library

Request Type: Patron physical item request

Request Note: No-Contact Pickup ★

Science and Engineering Library (Benedum Hall)

HECHT04

```
leader 00786pam a2200289 a 4500
001 9939859223406236
005 20191121100825.0
008 010523s2002 maua b 001 0 eng
010 ##$a 2001032540
035 ##$a(OCoLC)ocm47126713
035 ##$a3985922
035 ##$a(ppiu)3985922-pittdb
035 ##$a(pittdb)3985922-pittdb
040 ##$aDLC $cDLC
020 ##$a0805385665
049 ##$aPITT
050 00$aQC355.3 $b.H43 2002
082 00$a535 $221
100 1#$aHecht, Eugene.
245 10$aOptics / $cEugene Hecht.
250 ##$a4th ed.
260 ##$aReading, Mass. : $bAddison-Wesley, $cc2002.
300 ##$avi, 698 p. : $bill. ; $c24 cm.
504 ##$aIncludes bibliographical references (p. 685-688) and index.
650 #0$aOptics.
945 ##$aPromptCat $bApproval $cPITT
946 ##$ahill $bBookA $c31735045224650
947 ##$a89.04 $b725863
994 ##$a92 $bPIT
906 ##$aULS
```



University of Pittsburgh | PittCat

NEW SEARCH
BROWSE
JOURNAL FINDER
DATABASE FINDER

Sign in Menu

ASK US

Search anything Books, Articles, and More

Optics
Hecht, Eugene.
Not Available
Report Problem
5 versions found. See all versions

Send to

- CITATION
- EMAIL
- ENDNOTE/ZOTER
- PRINT
- PERMALINK

Get It

Please sign in to check if there are any request options. Sign in

BACK TO LOCATIONS

LOCATION ITEMS

Science and Engineering Library (Benedum Hall)
Out of library, General Collection 2 QC355.3 .H43 2002
(1 copy, 0 available, 1 request)

In transit until 08/19/2021
Loanable

Details

Title
Optics

Creator
Hecht, Eugene.

Language
English

Edition
4th ed.

Publisher
Reading, Mass. : Addison-Wesley

Date
c2002

Type
Book

Description
vi, 698 p. : ill. ; 24 cm.

Notes
Includes bibliographical references (p. 685-688) and index.

Subject
Optics

Identifier
LC : 2001032540
OCLC : (OCoLC)ocm47126713
ISBN : 0805385665

Source
Library Catalog

Virtual Browse



Links

Find this Item in Google Books >
 Display Source Record >

Syndetics Unbound

Summary Look Inside Browse Shelf Reader Reviews Also Available As

SUMMARY

Accurate, authoritative and comprehensive, *Optics, Fourth Edition* has been revised to provide readers with the most up-to-date coverage of optics. The market leader for over a decade, this book provides a balance of theory and instrumentation, while also including the necessary classical background. The writing style is lively and accessible.

LOOK INSIDE

- 1 A Brief History
- 2 Wave Motion
- 3 Electromagnetic Theory, Photons, and Light

[SEE FULL TABLE OF CONTENTS](#) [COVER](#)

READER REVIEWS

★ ★ ½ ★ ★ Reviewed by 3 people

What do you think? Write your own review

I had a course on Optics in my first year in University with this book. The book has lots of examples and is very "wordy". I suspect the author hoped to make it a reference as well as a study book. The number of photos in "Optics" is unusually high for a Physics book. I wouldn't mind if some of those were colour photos, but then again it would have made the book less affordable. Topics (read more)

I loathed this book when I was an undergraduate student, more so than any textbook I've ever encountered before or since. And what do you know? Reading it again, sixteen years later, I loathe it just as much. This was the book that instilled in me a hatred of everything and anything to do with optics, a hatred that persists to this day. It is the very fact that I hate optics so much that (read more)

Review by IvanIdris (LibraryThing) ★ ★ ★ ★ ★

Review by name99 (LibraryThing) ½ ★ ★ ★ ★ ★

[SEE MORE REVIEWS](#)

ALSO AVAILABLE AS



Paper Book

TAGS

light	applied physics	engineering		
reference	physics	university		science
optics	James	photonics	technical	office
interference	waves		Hecht	
	lasers			

[BROWSE TAGS](#)

BROWSE SHELF

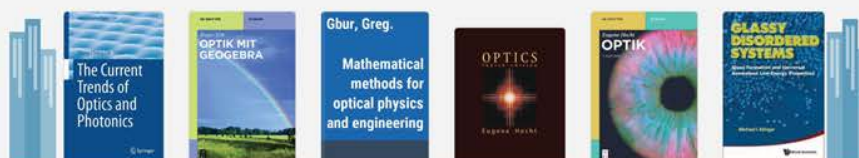

QC355.3 .C877 2015

QC355.3 .L564 2015

SEE FULL SHELF

 *Catalog enrichment powered by Syndetics Unbound*

KASAROVA01

Analysis of the dispersion of optical plastic materials [☆]

Stefka Nikolova Kasarova ^{a,*}, Nina Georgieva Sultanova ^a,
Christo Dimitrov Ivanov ^b, Ivan Dechev Nikolov ^b

^a University of Burgas, Department of Physics, 1 Prof. Yakimov Str., Burgas, Bulgaria

^b Sofia University, Faculty of Physics, Department of Optics and Spectroscopy, 5 J. Bourchier Blvd. Sofia, Bulgaria

Received 9 May 2006; received in revised form 17 July 2006; accepted 17 July 2006

Available online 7 September 2006

1. Introduction

At present plastic materials find wide application in consumer and high quality optics. Optical plastics (OPs) are used mainly in the visible (VIS) and near-infrared (NIR) spectral regions from 400 nm to 1100 nm. Success in application of OPs depends on knowledge of their optical refraction, transmission, birefringence, haze and homogeneity [1]. The optical properties of polymers are in details considered in [2]. Chromatic dispersion is an important characteristic in the design of optical systems and devices. However, measurements of refractive indices are usually realized at several selected wavelengths. Determination of more extensive refractometric data is possible using dispersion formulae [3,4].

The measuring methods for determination of OPs' refractometric characteristic are quite different. The refractive indices of transparent polymers can be obtained using the Federal Test Method Standard [5] in which the Abbe refractometer is applied. It operates with a white light source and Amici prisms as colour compensators. The refractive index value for the sodium *D*-line can be read directly from the instrument. However, the measuring accuracy is not acceptable for modern optical design projects. Furthermore, determination of refractive indices values can not be realized at different wavelengths. Utilization of Zeiss Pulfrich refractometer (PR2) is possible too [6,7]. We have measured the refractive indices in the VIS light using the PR2 instrument with its V-type prism [8] and additional goniometric set-up was applied for the entire

VIS and NIR regions. The obtained refractive values were compared with the data from Glass catalogues of OSLO [9], ZEMAX [10] and Code V [11]. Laser refractometric measurements of a number of OP specimens have been also accomplished using a He–Ne laser source with 632.8 nm emission wavelength [12].

Most widely used OPs are thermoplastics as polymethyl methacrylate (PMMA), polystyrene (PS), polycarbonate (PC), methyl methacrylate styrene copolymer (NAS), styrene acrylonitrile (SAN) and methylpentene (TPX) [1,13]. The only thermosetting plastic for optical applications is allyl diglycol carbonate (CR-39) [1]. The available catalogue data for refractive indices and dispersion characteristics of OPs is yet scanty. Useful data of commonly used transparent polymers is presented in Refs. [1,13]. The refractive indices of the principal OPs are included in many patents [14–17] and available online web-pages [18,19]. Companies producing trade-marks of optical polymers provide information on their refractometric and dispersive characteristics [20]. In comparison with glass, OPs have a restricted range of refractive indices and dispersion. The magnitude of the refractive index n_D at the sodium *D*-line (589.3 nm) usually varies from 1.47 to 1.59 [1,21]. The Abbe number of OPs is in the range from about 100 to a little less than 20 [1,21]. However, there are some differences in the reported refractometric data. For example, the refractive indices values of such a popular material as PMMA are different in references [15,16].

Recently it has been noticed considerable interest in the development of OP materials. Plastics replace glasses in products as objectives, lens arrays, aspheric and ophthalmic lenses, displays and lighting fixtures, windows, internally illuminated outdoor signs and skylights [21,22]. The improvement of manufacturing processes makes possible the utilization of OPs in medicine, military optics, sensors

[☆] This work is supported, in part, by the Burgas University “Assen Zlatarov” under Research Project NIH77.

* Corresponding author.

E-mail address: kasarova_st@yahoo.com (S.N. Kasarova).

and communications [21–24]. Chemical companies produce various trade-marks of OPs as NAS-21 Novacor[®], CTE-Richardson[®], Zeonex[®], Optorez[®], Bayer[®], etc. but some of them have close dispersion data. Our previous refractometric measurements [7] show for example that Optorez 1330[®] and S – low Styrene[®] have similar dispersive properties, Zeonex E48R[®] and COC[®] are equal, and Bayer[®] is a PC-type plastic material. Using some new optical materials the designers can improve the performance and balance the production expenses [13]. It seems that OPs can be both a low-cost alternative to glass and an option that provides more degrees of freedom for product and optical design.

In this paper we consider the refractometric and dispersion properties of OP materials in the region of normal dispersion. We have examined various types of OPs including the principal, selected trade marks and some control samples of polymers.

2. Theoretical analysis of dispersion

The interaction between the electromagnetic wave and the medium (the refractive index n , respectively) depends on its density and individual properties of the molecules on one hand, and the radiation wavelength on the other hand. A characteristic of the materials is the ratio, named a specific refraction $r = f(n)/\rho$, where ρ is the density of the substance and $f(n)$ is a function of the refractive index. The product of the specific refraction and molar mass is the molar refraction R often used in practice. Considering the effective electric field acting on a molecule in a polarizable medium, Lorentz and Lorenz have formulated theoretically [2] the molar refraction R_{LL} as

$$R_{LL} = \frac{n^2 - 1}{n^2 + 2} \frac{M}{\rho} = \frac{1}{3} N_A \alpha, \quad (2.1)$$

where M is the molar mass, α is the molecular polarisability and N_A is the Avogadro's number. The molar refraction is a material characteristic of the refraction properties which is independent on the density, temperature and physical state. This equation is valid for isotropic materials in cases of ultra-violet and visible illumination, where the electron polarisability is essential. For organic liquids Gladstone and Dale have obtained that at standard wavelengths the ratio $(n - 1)/\rho$ is a material characteristic constant and the molar refraction is:

$$R_{GD} = \frac{M}{\rho} (n - 1). \quad (2.2)$$

Another correlation between the chemical structure of electrically insulating materials and the refractive index has been proposed by Vogel [2]:

$$R_V = nM. \quad (2.3)$$

It is known that the refraction is an additive value. Therefore, the refractive index can be estimated using Eqs. (2.1), (2.2) and (2.3), if the structure of the compounds is known. Goedhart estimated the molar refraction values

of 43 functional groups, using an extensive regression analysis [2]. With his group contributions the refractive index can be predicted with an average standard deviation of about 0.4%.

Variation of the refractive index with respect to the wavelength depends also on the structure of the substance. In the spectral region of transmission the refractive index of the materials reduces towards longer wavelengths. Close to the absorption bands the refractive index enhances with the increase of the wavelength. The major OPs absorb in the blue portion of the visible spectrum and have some energy absorption at wavelengths of 900 nm, 1150 nm and 1350 nm in the NIR region [21]. At longer wavelengths high transmission is possible only in very thin sections of the material (0.022 mm) [1]. OPs become totally opaque at about 2100 nm [21]. The transmission characteristics depend strongly on quenching the material from temperature of about 213 °C to 147 °C in 60 s or less to prevent crystallization [1]. At wavelengths within the absorption bands intramolecular oscillations appear and the bond lengths and valence angles of molecules are altered. The more complex chemical structures of polymers increase the number of absorption bands and therefore influence the dependence of the refractive index on the wavelength.

There are several formulae in literature approximating the dispersion of optical materials. Most popular among them are the Hezberger's experimental formula [3], Cauchy's and Sellmeier's equations [4]. Only the last one, however, has physical ground. Dispersion can be explained by applying the classical electromagnetic theory to the molecular structure of the medium. Sellmeier has considered the substance as a system of elastically bounded particles with natural angular frequency ω_{0i} ($i = 1 \dots k$ – consecutive number of a single oscillator). The amplitude of the oscillations of bound charges forced by the electromagnetic wave increases at resonance frequency. According to Sellmeier's theory the well-known dependence of the refractive index on the wavelength is obtained:

$$n^2(\lambda) = 1 + \sum_{i=0}^k \frac{A_i \lambda^2}{\lambda^2 - \lambda_{0i}^2}, \quad (2.4)$$

where A_i are constants proportional to the number of oscillators with natural wavelengths λ_{0i} per unit volume.

An important characteristic of the dispersion properties of optical materials is their Abbe numbers, which usually decrease as the refractive indices increase. The USA standard Abbe number v_d is defined by the following ratio:

$$v_d = \frac{n_d - 1}{n_F - n_C}. \quad (2.5)$$

The difference $(n_F - n_C)$, named a principal dispersion, involves refractive indices n_F and n_C at the blue hydrogen F -line (486.13 nm) and red hydrogen C -line (656.27 nm). The Abbe number v_{804} which is a measure of partial dispersion in the NIR range is given by the equation

$$v_{804} = \frac{n_{804} - 1}{n_{703} - n_{1052}}, \quad (2.6)$$

where n_{703} , n_{804} and n_{1052} are the refractive indices at wavelengths 703 nm, 804 nm and 1052 nm, respectively. In Europe and Japan the Abbe number is defined according to the green mercury *e*-line (546.07 nm) as:

$$v_e = \frac{n_e - 1}{n_{F'} - n_{C'}}, \quad (2.7)$$

where $n_{F'}$ and $n_{C'}$ – refractive indices at the cadmium blue *F'*-line and red *C'*-line. Materials with low refractive indices usually have low dispersion behaviour and therefore a high Abbe number.

3. Measurement of the indices of refraction

In this study we apply the measuring method described in details in our paper [7]. The OPs' indices of refraction were measured with the aid of the Carl Zeiss Jena Pulfrich-Refractometer PR2 [8] in the visible spectral region at six standard spectral lines: green *e*-line 546.07 nm, blue *g*-line 435.83 nm, yellow *d*-line 587.56 nm, red *r*-line 706.52 nm, blue *F*-line 486.13 nm and red *C*-line 656.27 nm. We have chosen the *V*-type SF3 glass prism (VoF3 prism) which usually used for measuring liquids since the standard total internal reflection prism requires thick cubic of OP samples with satisfactory polished surfaces to observe a contrast image of the dividing border between the light and dark field in the eyepiece of the instrument. Furthermore, the standard prism does not avoid evaporating of the water contacting solutions and the precision of monitoring decreases at the end of the measuring series.

The examined OP specimens were prepared as injection moulded plates with thickness varying from 2.54 mm to 5.1 mm, except for the control samples which were cubic. Two mutually perpendicular surfaces of the samples were well polished to obtain a good refractometric data. Measuring temperature of 20 °C is maintained by a thermostat and temperature regulation is possible with stability of 0.2 °C. A saturated aqueous solution of zinc chloride ($n_e = 1.51$) and

silicon oil ($n_D = 1.56$) for low refractive OP samples as PMMA, and a saturated water solution of potassium–mercuric–iodide (KHgI) with $n_e = 1.73$ for higher refractive PS, PC, etc. have been chosen to ensure the optical contact during the measurements. Initial estimation of the indices of refraction of the OP samples and the choice of immersion emulsions have been accomplished by means of an ellipsometric laser system LEF-3 M-1 made by Carl Zeiss Jena which measuring accuracy of $\Delta n = \pm 0.002$ is completely insufficient to obtain precise OPs' refractometric data.

Refractive indices of OPs in VIS and NIR region are measured with the experimental set-up illustrated in Fig. 1. A G5-LOMO goniometer with an accuracy of one arc second was used with the VoF3 prism-measuring block positioned on the G5 test table. The lighting module operates with a 250 W halogen lamp applied over the entire VIS and NIR regions with interference filters (IF) made by Carl Zeiss (Jena). A new photo detector device was assembled with the aid of a plane silicon diode, operating amplifier and indicating module. The collimator forms a white light beam that falls on the fixed filter. The prism block with the OP sample is illuminated monochromatically. We found some differences in the spectral bandwidths and maxima of the filters. Therefore, the amplitude transmittances of the interference filters have been measured with the aid of Varian Carry 5 VIS-NIR spectrophotometer and all deviations were considered in presentation of the refractometric results.

The right-hand collimator with the attached photo detector determines the measuring angle α (see Fig. 1). The angle of deviation γ is formed by the OP sample located into the *V*-shaped prism. The refractive index n_λ of the examined OP is calculated as follows:

$$n_\lambda^2 = N_\lambda^2 - \cos \gamma \sqrt{N_\lambda^2 - \cos^2 \gamma}, \quad \gamma = 90^\circ - \alpha, \quad (3.1)$$

where N_λ is the refractive index of the VoF3 prism, γ is the calculated angle of the deviated beam, and α is the measured angle on the G5 set-up. The index N_λ of the SF3 glass is determined by the data published in [8] at standard spectral wavelengths. A new OptiColor program involving

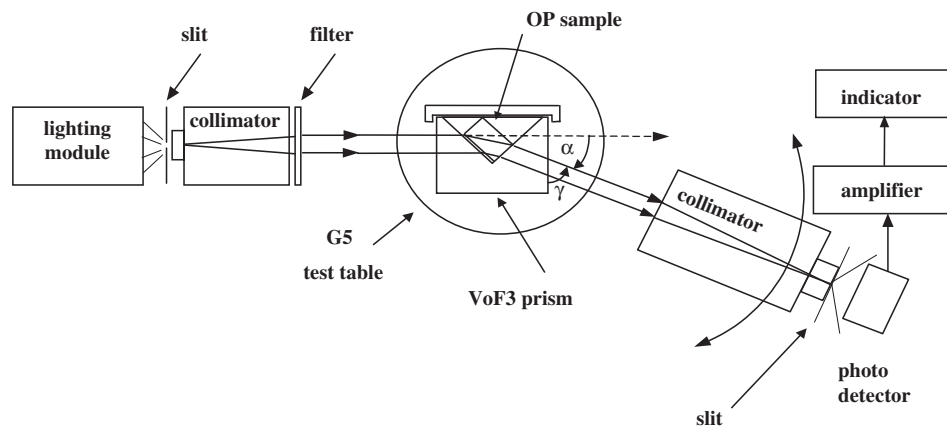

Fig. 1. Experimental set-up for measurement of the OP's refractive indices.

Table 1
Measured refractive indices of sixteen OP materials

Material	WLs (nm)					
	435.8	486.1	587.6	703	833	1052
PMMA	1.502	1.497	1.491	1.486	1.484	1.481
PS	1.617	1.606	1.592	1.582	1.577	1.572
PC	1.612	1.599	1.585	1.575	1.570	1.565
SAN	1.588	1.578	1.567	1.558	1.554	1.550
CTE Richardson [®]	1.602	1.593	1.580	1.571	1.566	1.562
NAS-21 [®]	1.593	1.584	1.571	1.564	1.558	1.554
S (low styrene) [®]	1.532	1.526	1.518	1.512	1.509	1.506
Optorez 1330 [®]	1.522	1.516	1.509	1.505	1.503	1.498
Zeonex E48R [®]	1.543	1.538	1.531	1.526	1.523	1.520
Bayer [®]	1.612	1.600	1.586	1.577	1.571	1.566
Cellulose ^a	1.480	1.477	1.471	1.466	1.463	1.461
Polyacrylate ^a	1.507	1.500	1.494	1.491	1.489	1.486
Styrene ^a	1.534	1.527	1.519	1.513	1.510	1.507
Polycarbonate ^a	1.597	1.587	1.572	1.565	1.560	1.555
Polystyrene ^a	1.615	1.604	1.592	1.582	1.576	1.572
Acrylic ^a	1.502	1.498	1.492	1.488	1.485	1.483

^a Control samples.

Cauchy’s dispersion formula was made to determine the dispersive coefficients of SF3 glass prism and then random refractive indices N_λ in VIS or NIR region are calculated.

The obtained measured data of the refractive indices of OPs at six wavelengths are presented in Table 1. The last six materials from Cellulose to Acrylic refer to laboratory specimens and are used as control samples. The presented values of measured refractive indices in Table 1 were obtained by averaging over all measured data of each series of at least five samples at given wavelength.

4. Computer modelling of dispersion

In spectral regions where materials are transparent and normal dispersion occurs ($\lambda \gg \lambda_{0i}$) Eq. (2.4) is reduced to Cauchy’s equation. In our previous works [7,12,25] we have applied a modified Cauchy’s approximation in the form:

$$n_\lambda^2 = A_1 + A_2\lambda^2 + \frac{A_3}{\lambda^2} + \frac{A_4}{\lambda^4} + \dots, \tag{4.1}$$

where $A_1, A_2, A_3, A_4, \dots$ are the calculated dispersion coefficients and λ is the wavelength expressed in microns.

We have studied the precision of this approximation in respect to the number of the involved dispersion coefficients. They were computed with the aid of linear systems consisting of four, five, six, seven and eight equations. The available optical catalogues do not provide sufficient data for refractive indices of OPs. Because of that, we have studied the accuracy of approximation (4.1) using the extensive refractometric information on optical glasses published in Glass Catalogues. Our calculations were made on the examples of catalogue data of SF3 [8] and SF6 glass [26]. The refractive indices are given with precision of 1×10^{-5} . Table 2 presents the results of our calculations for the SF6 type glass.

In column 2 the catalogue refractive indices at standard spectral lines are included. Columns 3, 4, 5, 6 and 7 present the deviation ΔN_λ between calculated and catalogue data. Blank places in these columns indicate the refractive indices used in the corresponding linear equation system involving 4, 5, 6, 7 or 8 dispersion coefficients in Eq. (4.1), respectively. A maximal error ΔN_λ of 0.00064 and 0.00026 in the blue area of the spectrum are obtained applying four and five dispersion coefficients. We found that the accuracy to the fifth decimal place, as in SCHOTT catalogue applying the Sellmeier’s approximation, is not achievable. Using six dispersion coefficients a maximal deviation up to 0.00007 is obtained (column 5). One can see that utilization of more than six terms in the approximating row does not change significantly this result (columns 6 and 7). Therefore, we found that the usage of six dispersion coefficients in Cauchy’s approximation is sufficient to provide the accuracy of ± 0.001 of calculated refractive indices. Better precision is achievable using Sellmeier’s approximation, which should be applied in case of experimental data presented to the fourth decimal point.

Table 2
Deviation of computed indices in respect to the catalogue data of SF6 glass

WLs (nm)	SF6 (SCHOTT)	Calculated error ΔN_λ				
		4 coeff.	5 coeff.	6 coeff.	7 coeff.	8 coeff.
404.7 (<i>h</i>)	1.86436	0.00064	0.00026	−0.00005	−0.00023	−0.00020
435.8 (<i>g</i>)	1.84707					
480 (<i>F'</i>)	1.82970	−0.00013	−0.00003	0.00001	0.00001	0.00001
486.1 (<i>F</i>)	1.82775	−0.00014	−0.00004			
546.1 (<i>e</i>)	1.81265	−0.00004	−0.00001	0	0	
587.6 (<i>d</i>)	1.80518					
589.3 (<i>D</i>)	1.80491	0	0	0	0	0
632.8 (laser)	1.79884	0.00002	0	0	0	0
643.9 (<i>C'</i>)	1.79750	0	−0.00001	−0.00001	−0.00001	−0.00001
656.3 (<i>C</i>)	1.79609	0.00001				
706.5 (<i>r</i>)	1.79117					
852.1 (<i>s</i>)	1.78157	−0.00004	0	−0.00001		
1014 (<i>t</i>)	1.77517					
1064 (laser)	1.77380	0.00010	0.00006	0.00007	0.00006	0.00006

According to the analysis of the approximation precision best results are obtained using six dispersion coefficients in Cauchy’s formula (4.1). We have realized the program OptiColor that allows us to compute the dispersion coefficients of any optical material in the region of normal dispersion. The input data consists of six refractive indices at selected measuring wavelengths (see Table 1). The dispersion coefficients from A_1 to A_6 can be calculated using the linear system consisting of six equations [7].

The obtained results are presented in Table 3. The computed dispersion coefficients vary in respect to the selected

wavelengths, but analysis shows that A_1 always corresponds to n^2 with accuracy to the first decimal place and $A_2 \dots A_6$ introduce additional corrections of higher accuracy.

Substituting the obtained dispersion coefficients in Cauchy’s dispersion formula (4.1), random refractive indices can be computed and compared with their measured values. We have calculated OPs’ refractive indices at selected laser wavelengths in our earlier works [7,12,27]. In this paper we present results at some additional laser emission wavelengths. The calculated refractive data of various OPs, SF3 and SF6 glasses are given in Table 4. The Abbe

Table 3
Computed dispersion coefficients of the examined OP materials

Material	Dispersion coefficients					
	A_1	A_2	A_3	A_4	A_5	A_6
PMMA	2.399964	-8.308636E-2	-1.919569E-1	8.720608E-2	-1.666411E-2	1.169519E-3
PS	2.610025	-6.143673E-2	-1.312267E-1	6.865432E-2	-1.295968E-2	9.055861E-4
PC	2.633127	-7.937823E-2	-1.734506E-1	8.609268E-2	-1.617892E-2	1.128933E-3
SAN	2.595568	-6.848245E-2	-1.459074E-1	7.329172E-2	-1.372433E-2	9.426682E-4
CTE Rich. [®]	2.663794	-1.059116E-1	-2.492271E-1	1.165541E-1	-2.211611E-2	1.545711E-3
NAS-21 [®]	2.054612	1.374019E-1	3.200690E-1	-1.152867E-1	2.077225E-2	-1.383569E-3
S (low styrene) [®]	2.360004	-4.014429E-2	-8.371568E-2	4.160019E-2	-7.586052E-3	5.071533E-4
Optorez 1330 [®]	2.291142	-3.311944E-2	-1.630099E-2	7.265983E-3	-6.806145E-4	1.960732E-5
Zeonex E48R [®]	2.482396	-6.959910E-2	-1.597726E-1	7.383333E-2	-1.398485E-2	9.728455E-4
Bayer [®]	2.542676	-4.366727E-2	-8.196872E-2	4.718432E-2	-8.892747E-3	6.324010E-4
Cellulose ^a	2.139790	-6.317682E-3	-5.920813E-3	9.613514E-3	-1.967293E-3	1.363793E-4
Polyacrylate ^a	2.364830	-6.955268E-2	-1.356107E-1	6.053900E-2	-1.166640E-2	8.542615E-4
Styrene ^a	2.274658	-5.700326E-3	-7.262838E-3	1.233343E-2	-2.481307E-3	1.784805E-4
Polycarbonate ^a	2.496875	-5.014035E-2	-4.188992E-2	1.732175E-2	-1.240544E-3	-1.977750E-5
Polystyrene ^a	2.721609	-9.982812E-2	-2.518650E-1	1.269202E-1	-2.549211E-2	1.867696E-3
Acrylic ^a	1.866120	2.085454E-1	4.806770E-1	-1.840693E-1	3.424849E-2	-2.340796E-3

^a Control samples.

Table 4
Abbe numbers and refractive indices of two glasses and sixteen OP materials calculated for ten laser wavelengths

Optical material	Abbe numbers		Lasing medium									
			GaN	Ar	Cu	Nd:YAG	He-Ne	Ruby	Krypton	Ti:Sapphire	Nd:YAG	Nd:YAG
	v_d	v_{804}	405 nm	488 nm	510.6 nm	532 nm	632.8 nm	694.3 nm	799.3 nm	860 nm	946 nm	1064 nm
SF3	28.14	48.48	1.7879	1.7582	1.7530	1.7488	1.7347	1.7292	1.7226	1.7189	1.7166	1.7133
SF6	25.44	44.81	1.8641	1.8272	1.8209	1.8158	1.7988	1.7923	1.7845	1.7801	1.7775	1.7737
PMMA	59.2	96.9	1.516	1.497	1.496	1.495	1.489	1.487	1.484	1.484	1.483	1.481
PS	30.5	56.6	1.634	1.605	1.602	1.599	1.587	1.583	1.578	1.576	1.574	1.572
PC	29.1	54.8	1.631	1.599	1.595	1.592	1.580	1.575	1.571	1.569	1.567	1.564
SAN	35.4	66.8	1.608	1.578	1.575	1.573	1.563	1.558	1.554	1.553	1.552	1.549
CTE Rich. [®]	32.8	58.5	1.612	1.592	1.589	1.587	1.576	1.571	1.567	1.566	1.564	1.562
NAS-21 [®]	35.5	56.3	1.588	1.583	1.580	1.577	1.568	1.564	1.559	1.557	1.555	1.554
S (low Styrene) [®]	44.9	79.6	1.542	1.526	1.524	1.522	1.515	1.512	1.510	1.509	1.508	1.506
Optorez 1330 [®]	52.0	71.9	1.531	1.516	1.514	1.513	1.507	1.505	1.503	1.502	1.501	1.498
Zeonex E48R [®]	56.5	100.7	1.555	1.537	1.536	1.535	1.528	1.526	1.524	1.523	1.522	1.520
Bayer [®]	30.0	54.5	1.623	1.599	1.596	1.593	1.582	1.578	1.572	1.570	1.568	1.566
Cellulose ^a	54.1	84.3	1.484	1.476	1.475	1.474	1.469	1.467	1.464	1.463	1.462	1.461
Polyacrylate ^a	63.3	97.8	1.521	1.499	1.498	1.497	1.492	1.491	1.490	1.488	1.487	1.485
Styrene ^a	42.9	77.3	1.540	1.527	1.525	1.523	1.516	1.514	1.510	1.509	1.508	1.507
Polycarbonate ^a	28.9	56.7	1.602	1.586	1.582	1.579	1.568	1.565	1.561	1.559	1.557	1.554
Polystyrene ^a	32.0	55.5	1.640	1.604	1.601	1.598	1.587	1.582	1.577	1.576	1.574	1.571
Acrylic ^a	57.8	97.2	1.506	1.498	1.495	1.495	1.490	1.488	1.486	1.485	1.484	1.483

^a Control samples.

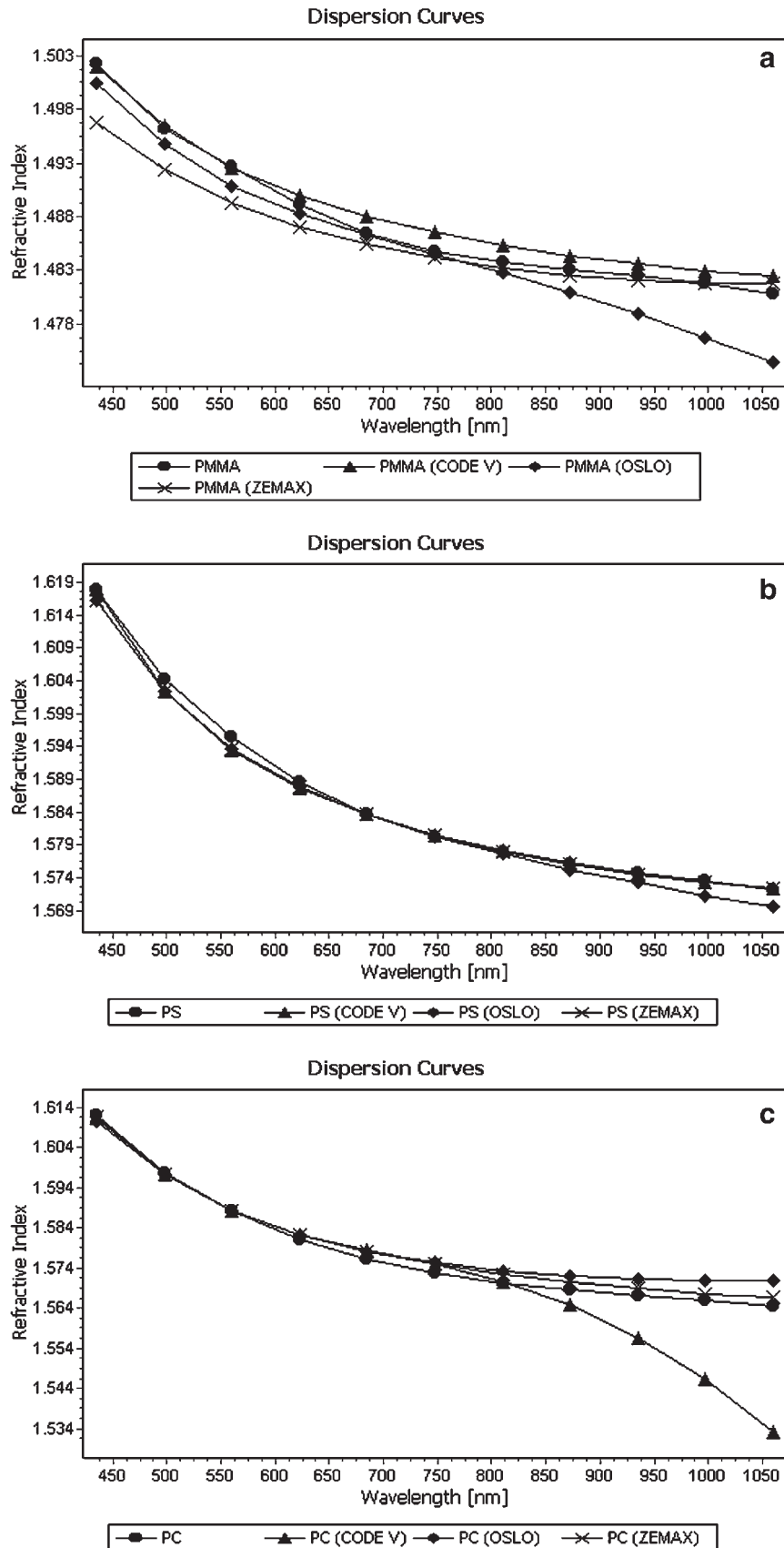

Fig. 2. Comparison of computed dispersion curves on the base of different input data for: (a) PMMA; (b) PS and (c) PC.

numbers v_d and v_{804} estimating the principal and partial dispersion, respectively, are presented in the same table.

Another option of the OptiColor program is calculation and illustration of dispersion curves of the examined material in a defined spectral area of normal dispersion. Plots of refractive indices versus wavelength for each optical polymer can be drawn. Fig. 2 presents calculated dispersion charts of the principal OPs plotted in our program on the base of our results [7] and published data of OSLO [9], ZEMAX [10] and Code V [11] program packages. A comparative analysis between the obtained dispersion curves is possible. According to approximation (4.1) the dispersion diagrams should be smooth and monotonously decreasing in the range of normal dispersion as it can be seen for dispersion curves computed on the base of our measurements. Fig. 2(a) illustrates significant differences among the obtained results in respect to the measuring method and involved approximation. Curve PMMA refers to our mea-

suring data and it is calculated by means of Eq. (4.1). It is obviously identical with curve PMMA (OSLO) in the visible part of the spectrum, but there is an intersection point between both curves in the NIR-region. This means that $dn/d\lambda$ in both cases are different. However, our curve coincides with the PMMA – curve of ZEMAX in the NIR-spectrum. It is also obvious that curves' behaviour of measured PMMA and PMMA (CODE V) are very similar in respect to the variation of $dn/d\lambda$.

As it can be seen in Fig. 2(b) and (c) all calculated curves of PS and PC are strictly identical in the whole VIS region from 400 nm and further up to 800 nm. There are slight differences of PS and PC curves in the NIR (800–1100 nm) and largest deviation occurs for PC (CODE V) at 1050 nm. In general, the presented dispersion diagrams show good coincidence of the obtained results. The deviations in the NIR are probably due to the measuring accuracy of the various methods. In this spectral area the

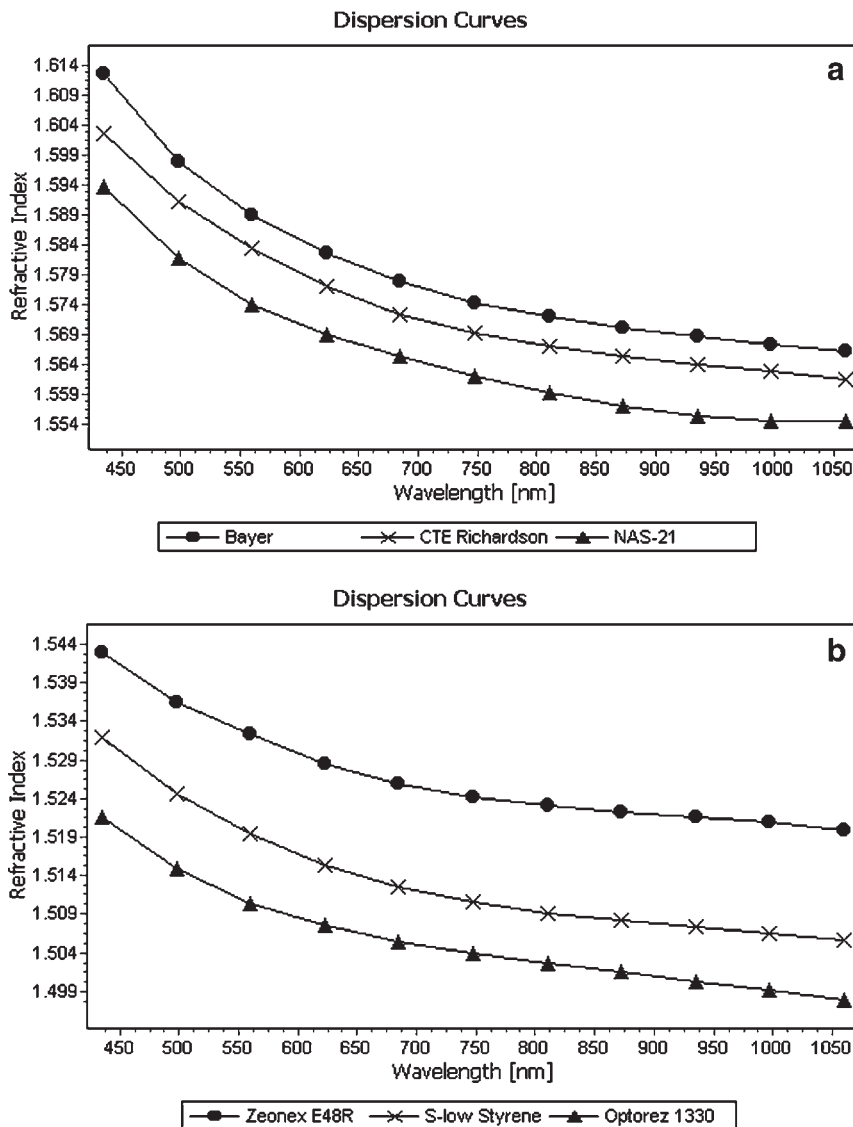

Fig. 3. Dispersion charts of selected trade-marks of OPs: (a) $n > 1.54$ and (b) $n < 1.54$.

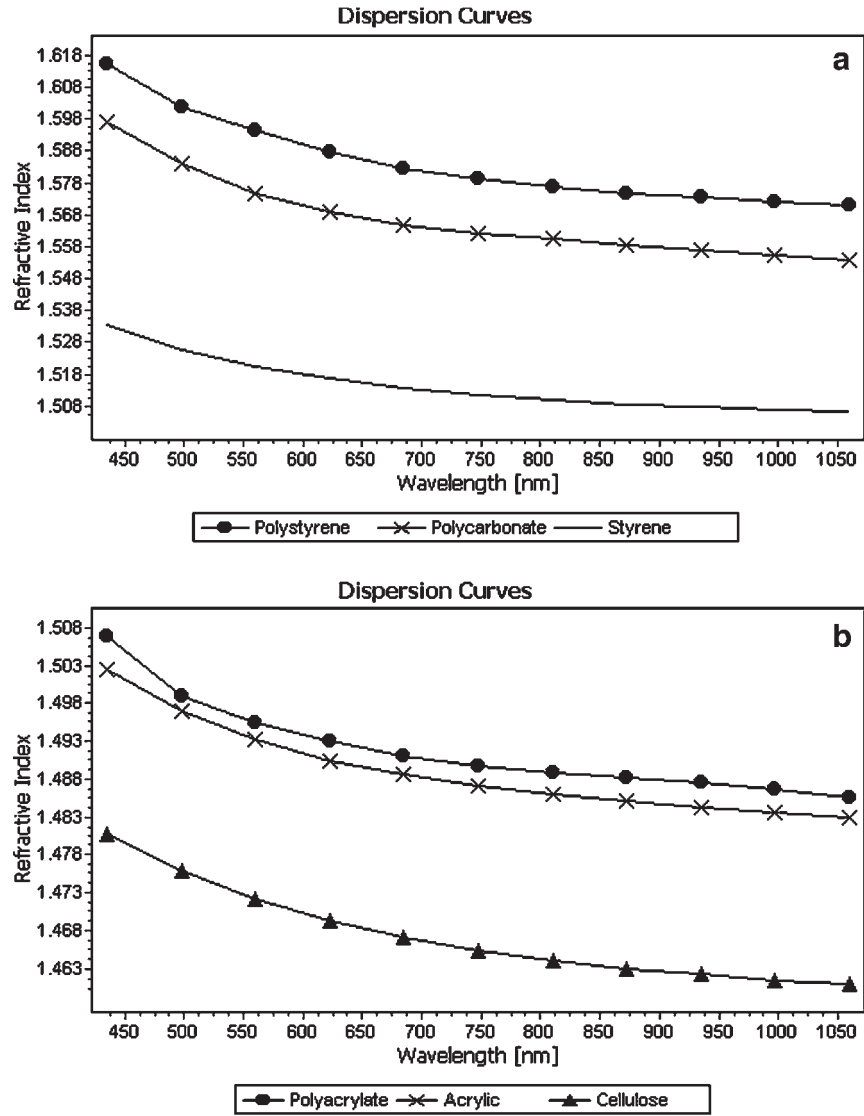

Fig. 4. Dispersion curves of control samples with: (a) higher refractive and (b) lower refractive polymers.

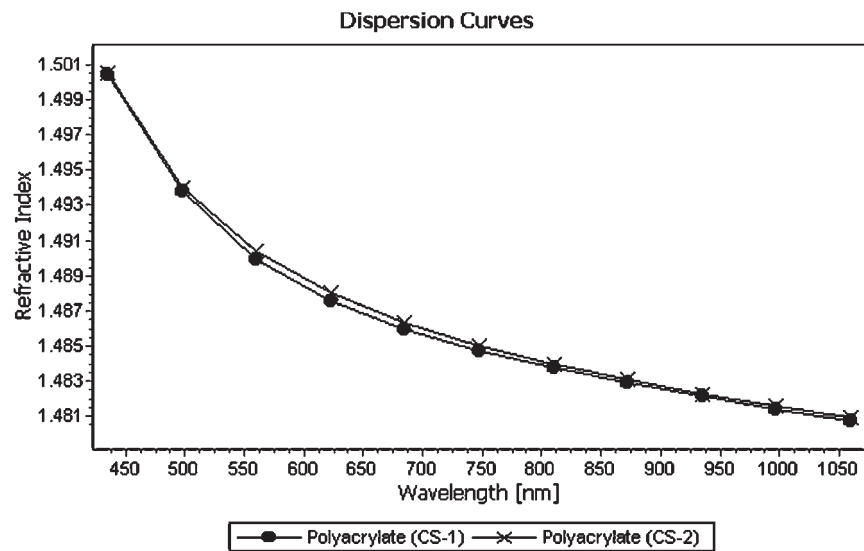

Fig. 5. The influence of birefringence and internal stresses on the refractive index values.

refractive index shows lower dependence on the wavelength and the accuracy falls down. In case of PMMA, the distinction of curves could be interpreted in a similar way. Since the refractive index is lower, stronger dependence of the measuring accuracy on the applied refractometric instruments is encountered. Obviously, birefringence and internal stresses in the samples play an additional role, too.

Computed dispersion curves on the base of measured data (Table 1) are illustrated in Figs. 3 and 4. Presentation of several dispersion curves in one diagram makes possible the comparison between the values of refractive indices and dispersion behaviour of the optical polymers. Dispersion charts of selected trade-marks (Fig. 3) and control samples (Fig. 4) are grouped into two categories: OPs with higher refractive indices (Fig. 3(a) and Fig. 4(a)) and lower refractive OP materials (Fig. 3(b) and Fig. 4(b)). The dissimilarity of the computed curves' slopes in the NIR region (see, for example, SAN, NAS-21 and Optorez 1330) is also connected with the higher measuring errors.

Internal stresses develop when a plastic part is injection moulded as a result of a temperature cycle involved [1,21]. These stresses create two indices of refraction, one in the direction of the flow and the other across the flow of the hot material. In this way birefringence arises. Bulk plastics retain residual stresses even after annealing. For example, the difference of refractive indices for PS could be as high as 8×10^{-3} [1,21]. The moulding process may introduce inhomogeneity too. The influence of these effects on the refractometric properties of OPs is presented for two control samples (CS-1 and CS-2) of Polyacrylate in Fig. 5. Birefringence was established in advance with the aid of a polariscope. The measuring accuracy of our refractive index measuring method and the flexibility of the new OptiColor program as well, allowed us to detect and illustrate small differences in refractive indices values.

5. Summary and discussions

In this paper some new measuring results for refractive and dispersion properties of OPs are presented and discussed. Refractometric measurements of sixteen American, Japanese and German OP materials were accomplished with the aid of the *V*-type prism on the Zeiss Pulfrich PR2 instrument at standard spectral lines. Additional goniometric set-up with the same *V*-type SF3 glass prism, white lighting module with interference filters, and a new sensitive photodetector device was also applied in the entire VIS and NIR spectral regions from 546 nm to 1052 nm (see Fig. 1). Our measuring results are presented with an uncertainty to the third decimal place (Table 1).

Computing accuracy of the Cauchy's approximation formula (Eq. (4.1)) is analysed on the base of glass catalogue data. Our examination shows that the usage of six dispersion coefficients ensures calculation accuracy of random refractive indices to the fourth decimal place in the region of normal dispersion (Table 2).

A new OptiColor program for computing of the dispersive properties of any optical material in the region of normal dispersion is realized. Our program calculates the dispersion coefficients (Table 3), random refractive indices and dispersion charts of the examined materials (Figs. 2–5). The Abbe numbers v_d for the principal and v_{804} for the partial dispersion are estimated. Refractive indices of the sixteen examined OPs at ten laser wavelengths in the VIS and NIR spectral areas are also calculated (Table 4).

Generation of various dispersion curves is another option of the program (Figs. 2(a)–(c)). In this way, comparative analysis of distinct input data is possible. The OptiColor program gives us the opportunity to distinguish similar dispersion curves of different samples worked out of one and the same type of material, if the input data of refractive indices differs in the third or fourth decimal place. Such variation of measured data is possible in case of inhomogeneity or birefringence of the moulded polymer samples (Fig. 5). These results demonstrate the sensitivity of the OptiColor program and prove its precision in calculations and plotting the dispersion charts.

In conclusion, the newly reported refractometric and dispersion data give detailed information about the optical properties of the examined sixteen types of OP materials. Our results could be very useful for experts from the field of physics, chemistry, optical design and photonics technology.

Acknowledgement

The authors wish to thank Dr. Wesley R. Hale from Eastman Chemical Company for helpful discussions and providing the OP materials for producing the control samples.

References

- [1] The Handbook of Plastic Optics, U.S. Precision Lens, Ohio 45245, Cincinnati, 1973. (Chapter 2).
- [2] D.W. Van Krevelen, Properties of Polymers, Elsevier, Amsterdam, 1997 (Chapter 10).
- [3] M. Herzberger, Modern Geometrical Optics, E. Kodak Com, Rochester, New York, 1958 (Chapter 12).
- [4] R.S. Longhurst, Geometrical and Physical Optics, Longman Scientific, England, 1973.
- [5] Federal Test Method Std, No. 406 Method 3011: Index of Refraction, 1961.
- [6] I. Nikolov, C. Ivanov, Appl. Opt. 39 (2000) 2067.
- [7] N. Sultanova, I. Nikolov, C. Ivanov, Opt. Quantum Electron. 35 (2003) 21.
- [8] The Manual of Pulfrich-Refraktometer PR2, Carl Zeiss JENA Jena D-77830, Germany, 1976.
- [9] OSLO Optical Design Software, Available from: <<http://www.sin-opt.com>>, 1999.
- [10] ZEMAX Optical Design Software, Available from: <<http://www.focus-software.com>>, 1999.
- [11] Code V Design program, Available from: <<http://www.optical-res.com>>, 2000.
- [12] I. Nikolov, N. Sultanova, S. Kasarova, Proc. In SPIE 5830 (2005) 511.

- [13] D.F. Horne, Optical Production Technology, Adam Hilger Ltd, 1983, p. 253.
- [14] N. Arai, Projection lens for a television projector, U.S. Patent 4.666.261, 1987.
- [15] H. Yamada, Projection lens system for projectors, U.S. Patent 5.212.597, 1993.
- [16] J. Moskovich, Color corrected projection lens, U.S. Patent Number Re. 35.310, 1996.
- [17] M. Kreitzer, J. Moskovich, Wide-angle DMD projection lens, U.S. Patent 5.870.228, 1999.
- [18] Property data, Styron Inc, Available from: <<http://www.matweb.com>>, 2003.
- [19] Plastics Sheet, Boedeker Plastics Inc, Available from: <<http://www.boedeker.com>>, 2004.
- [20] Nippon Zeon Company, Opt. Polym. Dept., Japan, Tokyo, 1999.
- [21] K. Kogler, Selection of plastics for optical applications, Available from: <<http://amptiac.alionscience.com>>, 1999.
- [22] W.S. Beich, Photon. Spectra (2002) 127, March.
- [23] D.L. Keyes, R. Lamonte, D. McNally, M. Bitritto, Photon. Spectra (2001) 131, October.
- [24] P. Tolley, Photon. Spectra (2003) 76, October.
- [25] I.D. Nikolov, C. Ivanov, Proc. SPIE 3573 (1998) 409.
- [26] Optical Glass Data SHEETS, SCHOTT Glass Technologies, Available from: <<http://www.us.schott.com>>, 1996.
- [27] N. Sultanova, S. Kasarova, C. Ivanov, I. Nikolov, Proc. SPIE vol. "Holography '05" 6252 (2006).

KASAROVA02

Search anything

ND Catalog

All Notre Dame Campus Libraries



ADVANCED SEARCH

All items that contain my search terms anywhere in the record

CLEAR SEARCH TERMS

Search In: WorldCat Google Scholar Yewno

BACK TO RESULTS LIST



JOURNAL
Optical materials.
Amsterdam : North-Holland, 1992-

[View Journal Contents](#)

EXPORT



ONLINE ACCESS



DETAILS

MORE LINKS

VIRTUAL SHELF

TAGS

Online Access

[Elsevier ScienceDirect](#)

Available from 1992

[Elsevier SD Backfile Complete](#)

Available from 1992/01/01 volume: 1 issue: 1 until 1994/12/31 volume: 4 issue: 1

[Find in FindText](#)

Details

Title Optical materials.
Uniform Title Optical materials (Amsterdam, Netherlands : Online)
Published Amsterdam : North-Holland
1992-
Twelve issues a year, 2001-
Published Amsterdam : North-Holland
1992-
Twelve issues a year, 2001-
Began with Vol. 1, issue 1 (Jan. 1992)-
Language English
General Notes Title from contents screen (ScienceDirect, viewed Nov. 17, 2005).
Local Notes:
Subjects [Optical materials -- Periodicals](#)
Uniform Title Link [Optical materials \(Amsterdam, Netherlands : Online\)](#)
Identifier ISSN: 0925-3467
ISSN: 0925-3467 1873-1252
OCLC : 39097987
Record ID [001779803 \(Notre Dame Catalog Classic\)](#)
Type Journal

[Report a problem with this record](#)

More Links

[Notre Dame Catalog](#)

[Staff MARC View](#)

Virtual Shelf

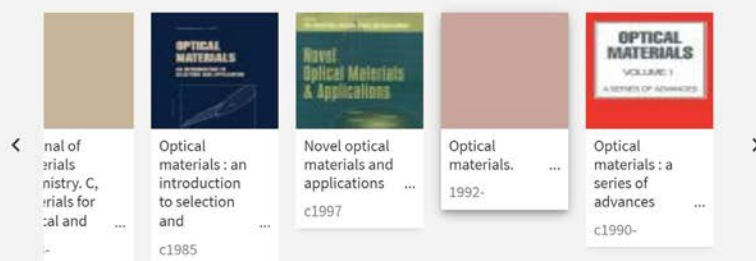



SJR: 0.59

Optical Materials

➕ ADD TO MY BOOKSHELF

JOURNAL ISSUES

2021	Vol 30 Issue 4
2020	Vol 30 Issue 3
2019	Vol 30 Issue 2
2018	Vol 30 Issue 1
2017	Vol 29 Issue 12
2016	Vol 29 Issue 11 >
2015	Vol 29 Issue 10
2014	Vol 29 Issue 9
2013	Vol 29 Issue 8
2012	Vol 29 Issue 7
2011	Vol 29 Issue 6
2010	Vol 29 Issue 5
2009	
2008	
2007 >	
2006	
2005	
See All	↗

BROWSE RELATED SUBJECTS

📁 Polymer and Organic Materials

2007

Vol. 29 Issue 11

IFC (Editorial Board)

p. IFC



Light emission and excitonic effect of boron nitride nanotubes observed by photoluminescent spectra

pp. 1295-1298 - Chen, Hua; Chen, Ying; Liu, Yun; ... Williams, Jim S.



Energy transfer between organic fluorescent CBP host and blue phosphorescent FIrpic and FIrN4 guests

pp. 1299-1304 - Tsuboi, Taiju; Murayama, Hideyuki; Yeh, Shih-Jay; ... Chen, Chin-Ti



Study on nonlinear optical properties of two novel dmit2- salts by Z-scan technique

pp. 1305-1309 - Sun, Xiang-Bing; Wang, Yan-Ling; Ren, Quan; ... Xu, Dong



Size and shape-dependent electron-hole relaxation dynamics in CdS nanocrystals

pp. 1310-1320 - Sarkar, Rupa; Shaw, Ajay Kumar; Narayanan, S. Shankara; ... Pal, Samir Kumar



An investigation of the optical properties of Nd³⁺ ions in alkali tellurofluorophosphate glasses

pp. 1321-1326 - Jayasimhadri, M.; Rama Moorthy, L.; Ravikumar, R.V.S.S.N.



Preparation and luminescence properties of Eu²⁺ in SiO₂ xerogels

pp. 1327-1331 - Hu, Xiaoyun; Fan, Jun; Li, Ting; ... Hou, Xun



Ambipolar organic phototransistor

pp. 1332-1337 - Saragi, Tobat P.I.; Onken, Kristian; Suske, Irina; ... Salbeck, Josef



Characterization of Y₂SiO₅:Ce thin films

pp. 1338-1343 - Coetsee, E.; Swart, H.C.; Terblans, J.J.; ... Buttner, U.



Antimony germanium sulphide amorphous thin films fabricated by chemical vapour deposition

pp. 1344-1347 - Huang, C.C.; Knight, K.; Hewak, D.W.



Absorption characteristic and limiting effect of Congo red doped PVA film

pp. 1348-1351 - Qi, Shengwen; Zhang, Chunping; Yang, Xiuqin; ... Tian, Jianguo



Dominant red emission (4F_{9/2}→4I_{15/2}) via upconversion in YAG (Y₃Al₅O₁₂):Yb³⁺,Er³⁺ nanopowders

pp. 1352-1357 - Liu, M.; Wang, S.W.; Zhang, J.; ... Chen, L.D.





Structural and optical properties of P-Ga codoping ZnO thin films deposited by magnetron sputtering

pp. 1358-1361 - Wang, Q.P.; Sun, Z.; Du, J.; ... Zhang, X.J.



The influence of sintering temperature on particle size/shape and photoluminescence characteristics of CaIn₂O₄:xTb synthesized by combustion process

pp. 1362-1366 - Khatkar, S.P.; Han, Sang Do; Taxak, V.B.; ... Kumar, Dinesh



Binding of europium complex to polymerizable macrocyclic molecules and its optical properties

pp. 1367-1374 - Hidayat, Rahmat; Sugihara, Okihiro; Tsuchimori, Masaaki; ... Kaino, Toshikuni



Synthesis and characterization of a photochromic sol-gel material functionalized with azo dye

pp. 1375-1380 - Ke, Xianjun; Yan, Xingzhong; Song, Sangyup; ... Wang, Michael R.



Crystal growth, optical and luminescence properties of Pr-doped Y₂SiO₅ single crystals

pp. 1381-1384 - Novoselov, A.; Ogino, H.; Yoshikawa, A.; ... Fukuda, T.



Charge transfer model of metal-insulator phase transition and ultrafast optical response in VO₂

pp. 1385-1389 - Vikhnin, V.S.; Lysenko, S.; Rua, A.; ... Liu, H.



Growth and characterization of Tm-doped Y₂O₃ single crystals

pp. 1390-1393 - Mun, J.H.; Jouini, A.; Novoselov, A.; ... Fukuda, T.



Light-induced metastable states in ferroelectric oxides

pp. 1394-1399 - Liu, G.K.; Vikhnin, V.S.; Kapphan, S.E.



Recharging processes of active ions and radiation defects in some laser crystals doped with RE and TM ions under proton irradiation

pp. 1400-1407 - Kaczmarek, Sławomir M.



Studying the temperature dependence of the laser induced birefringence in azo dye doped polymer films

pp. 1408-1415 - Mohajerani, Ezeddin; Nataj, Nahid Hosain



Effect of electric field and temperature on holographic scattering from holographic polymer-dispersed liquid crystals

pp. 1416-1422 - Ellabban, M.A.; Drevenšek-Olenik, I.; Fally, M.; ... Uršič, H.



Synthesis and properties of nonlinear optical chromophore containing alkoxy-substituted phenylene as conjugation bridge

pp. 1423-1428 - Kim, Dong Wook; Yoon, Sung Cheol; Lim, Jong-Sun; ... Lee, Changjin



Optical spectroscopy of Sm³⁺ ions in phosphate and fluorophosphate glasses

pp. 1429-1439 - Venkatramu, V.; Babu, P.; Jayasankar, C.K.; ... Wortmann, G.



New low symmetry centres of Yb³⁺ impurities in lithium niobate single crystal

pp. 1440-1446 - Bodziony, T.; Kaczmarek, S.M.



Studies on Eu doped Ba and Zn aluminate phosphors prepared by combustion synthesis

pp. 1447-1451 - Singh, Vijay; Natarajan, V.; Zhu, Jun-Jie



Indirect sensitization blue-upconversion wavelength vary in Tm³⁺/Yb³⁺ co-doped TeO₂-TiO₂-K₂O glasses

pp. 1452-1455 - Su, Fangning; Deng, Zaide



Absorption spectra of gamma-irradiation TM-doped cabal glasses

pp. 1456-1466 - Marzouk, Samir Y.; Elbatal, Fatma H.; Salem, A.M.; ... Abo-Naf, S.M.



Spectroscopic properties of copper ions in ZnO-ZnF₂-B₂O₃ glasses

pp. 1467-1474 - Naga Raju, G.; Srinivasa Reddy, M.; Sudhakar, K.S.V.; ... Veeraliah, N.



Thermal stability and optical transitions of Er³⁺/Yb³⁺-codoped barium gallogermanate glass

pp. 1475-1480 - Xiao, Kai; Yang, Zhongmin



Analysis of the dispersion of optical plastic materials

pp. 1481-1490 - Kasarova, Stefka Nikolova; Sultanova, Nina Georgieva; Ivanov, Christo Dimitrov; ... Nikolov, Ivan Dechev



Preparation and luminescence properties of CaSnO₃:Sm³⁺ phosphor emitting in the reddish orange region

pp. 1491-1494 - Lei, Bingfu; Li, Bin; Zhang, Haoran; ... Li, Wenlian



Structural and optical characterization of CdSe nanocrystallites/rare earth ions in sol-gel glasses

pp. 1495-1500 - Jose, Gijo; Joseph, Cyriac; Ittyachen, M.A.; ... Unnikrishnan, N.V.



New nonlinear optical LiKB₄O₇ single crystals: Dispersion of refractive indices

pp. 1501-1504 - Adamiv, V.T.; Burak, Ya.V.; Romanyuk, M.M.; ... Teslyuk, I.M.



Preparation and characterization of nanoscale lutetium aluminium garnet (LuAG) powders doped by Eu³⁺

pp. 1505-1509 - Uhlich, Dominik; Huppertz, P.; Wiechert, D.U.; ... Jüstel, Thomas



Oligoetheracrylate polymers as new promising materials for photooperated transparency

pp. 1510-1513 - Ozga, K.



Efficient red organic light-emitting diodes based on a dinuclear europium complex

pp. 1514-1517 - You, Han; Fang, Junfeng; Wang, Lihong; ... Ma, Dongge



Synthesis of new donor-fluorene-donor type organic dyes and their nonlinear absorption properties

pp. 1518-1522 - Yoon, Kuk Ro; Sung, Jae Ho; Kim, Doseok; ... Lee, Hoosung



Development of ion-implanted optical waveguides in optical materials: A review

pp. 1523-1542 - Chen, Feng; Wang, Xue-Lin; Wang, Ke-Ming



Microstructures and properties of ORMOSIL comprising methyl, vinyl, and γ -glycidoxypropyl-substituted silica

pp. 1543-1547 - Chan, Zheng; Ai'mei, Lin; Xiao, Zhen; ... Hongbing, Zhan



Conductivity enhancement and semiconductor-metal transition in Ti-doped ZnO films

pp. 1548-1552 - Lu, J.J.; Lu, Y.M.; Tasi, S.I.; ... Jang, L.Y.



Growth and optical properties of Yb³⁺-doped Ba₃Y₂(BO₃)₄ crystal

pp. 1553-1556 - Ma, Ping; Lin, Zhoubin; Wang, Guofu



Luminescence of Er³⁺-doped nanostructured SiO₂-LaF₃ glass-ceramics prepared by the sol-gel method

pp. 1557-1561 - Rodr'iguez, V.D.; Del Castillo, J.; Yanes, A.C.; ... Peraza, J.



MENDELSON01

IEEE
TRANSACTIONS
ON BIOMEDICAL
ENGINEERING

35

1988



THE CARNEGIE
LIBRARY OF
PITTSBURGH

RM
MR07'89

Noninvasive Pulse Oximetry Utilizing Skin Reflectance Photoplethysmography

YITZHAK MENDELSON, MEMBER IEEE, AND BURT D. OCHS, MEMBER IEEE

Abstract—The major concern in developing a sensor for reflectance pulse oximetry is the ability to measure large and stable photoplethysmograms from light which is backscattered from the skin. Utilizing a prototype optical reflectance sensor, we showed that by locally heating the skin it is possible to increase the pulsatile component of the reflected photoplethysmograms. Furthermore, we showed that additional improvements in signal-to-noise ratio can be achieved by increasing the active area of the photodetector and optimizing the separation distance between the light source and photodetector. The results from a series of *in vivo* studies to evaluate a prototype skin reflectance pulse oximeter in humans are presented.

I. INTRODUCTION

NONINVASIVE monitoring of arterial hemoglobin oxygen saturation (SaO_2) based upon skin reflectance spectrophotometry was first described by Brinkman and Zijlstra in 1949 [1]. They showed that changes in SaO_2 can be recorded noninvasively from an optical sensor attached to the forehead. Their innovative idea to use light reflection instead of tissue transillumination, which is limited mainly to the finger tips and ear lobes, was suggested as an improvement to enable noninvasive monitoring of SaO_2 from virtually any skin surface. More recent attempts to develop a skin reflectance oximeter utilizing a similar spectrophotometric approach were made by Cohen *et al.* [2] and Takatani [3]. All of those three noninvasive reflectance oximeters attempted to monitor SaO_2 by measuring the absolute light intensity diffusely reflected (backscattered) from the skin.

While those developments represent significant advancements in noninvasive reflectance oximetry, limited accuracy as well as difficulties in absolute calibration were major problems with early reflectance oximeters. Although various methods have been proposed, to date, a versatile noninvasive reflectance oximeter, which can monitor SaO_2 reliably from any location on the skin surface, is not yet available.

Backscattered light from living skin depends not only on the optical absorption spectrum of the blood but also on the structure and pigmentation of the skin. In an attempt to overcome this problem, Mendelson *et al.* [4]

proposed to measure SaO_2 based on the principle of skin reflection photoplethysmography. We showed that SaO_2 can be measured noninvasively by analyzing the pulsatile rather than the absolute, reflected light intensity I_r of the respective red and infrared photoplethysmograms according to the following empirical relationship [4]–[5]:

$$\text{SaO}_2 = A - B [I_r(\text{red})/I_r(\text{infrared})] \quad (1)$$

where A and B are empirically derived constants which are determined statistically during *in vivo* calibration in which the $I_r(\text{red})/I_r(\text{infrared})$ ratio calculated by the pulse oximeter is compared against direct blood SaO_2 measurements. I_r is obtained by a normalization process in which the pulsatile (ac) component of the red and infrared photoplethysmograms is divided by the corresponding nonpulsatile (dc) component.

In clinical applications where presently available transmission pulse oximeters cannot be used, there is a need for an optical sensor which is suitable for monitoring SaO_2 utilizing light reflection from the skin. Although the principles of reflection and transmission pulse oximetry are very similar, the major limitation of reflection pulse oximetry is the comparatively low level photoplethysmograms typically recorded from the skin. The feasibility of reflection pulse oximetry, therefore, is highly dependent on the ability to detect sufficiently strong reflection photoplethysmograms.

This paper describes the considerations in designing a skin reflectance sensor for noninvasive monitoring of SaO_2 . The ability to detect improved photoplethysmographic waveforms through the use of skin heating and multiple photodetectors are discussed. Results from a series of *in vivo* studies to evaluate a prototype skin reflectance pulse oximeter in humans are presented.

II. BACKGROUND

A. Principle of Pulse Oximetry

Pulse oximetry has been invented by Aoyagi *et al.* [6] and further refined by Nakajima *et al.* [7] and Yoshiya *et al.* [8]. This unique approach is based on the assumption that the change in light absorbed by tissue during systole is caused primarily by the arterial blood. Consequently, they showed that changes in light transmission through a pulsating vascular bed can be used to obtain an accurate noninvasive measurement of SaO_2 .

The main advantage of employing a photoplethysmo-

Manuscript received June 17, 1987; revised May 9, 1988. This work was supported by the Whitaker Foundation and the National Science Foundation under Grant ECS-8404397.

The authors are with the Biomedical Engineering Program, Worcester Polytechnic Institute, Worcester, MA 01609.

IEEE Log Number 8822615.

graphic technique is that only two wavelengths are required, thereby greatly simplifying the optical sensor. Furthermore, the requirement for blood "arterialization" which was essential in previous nonpulsatile oximeters, such as the eight wavelength Hewlett-Packard (HP) ear oximeter [9], has been eliminated. Hence, there is no need for continuous skin heating. Moreover, skin pigmentation, which can cause variable light attenuation, does not seem to affect the accuracy of pulse oximeters. This is because the ratio of the transmitted red/infrared light intensity, from which SaO_2 is calculated, is obtained by a normalization process in which the ac component of the red and infrared photoplethysmograms is divided by the corresponding dc components.

The basic optical sensor of a noninvasive pulse oximeter consists of a red and infrared light emitting diodes (LED's) and a silicone photodiode. The wavelength of the red LED is typically chosen from regions of the spectra where the absorption coefficient of Hb and HbO_2 are markedly different (e.g., 660 nm). The infrared wavelength, on the other hand, is typically chosen from the spectral region between 940 and 960 nm where the difference in the absorption coefficients of Hb and HbO_2 is relatively small. The photodiode used has a broad spectral response that overlaps the emission spectra of the red and infrared LED's.

The light intensity detected by the photodetector depends, apart from the intensity of the incident light, mainly on the opacity of the skin, reflection by bones, tissue scattering, and the amount of blood present in the vascular bed. The amount of light attenuated by the blood varies according to the pumping action of the heart. Consequently, as tissue blood volume increases during systole, a greater portion of the incident light is absorbed by the arterial blood causing a rapidly alternating signal. Depending on the physiological state of the microvascular bed, typically, these alternating light intensity amounts to approximately 0.05–1 percent of the total light intensity either transmitted through or backscattered from the skin.

Since pulse oximeters rely on the detection of arterial pulsation, significant reduction in peripheral blood flow, such as in hypotension or hypothermia, can limit the reliability of the measurement. Nevertheless, the fact that no user calibration or site preparation is required, and the availability of small, light weight, and easy to apply sensors has made transmission pulse oximeters very popular in various clinical applications.

B. Reflection Versus Transmission Pulse Oximetry

In transmission pulse oximetry, sensor application is obviously limited to areas of the body, such as the finger tips, ear lobes, toes, and in infants the foot or palms where transmitted light can be readily detected. Other locations, which are not accessible to conventional transillumination techniques, i.e., the limbs, forehead, and chest may be monitored in principle using a reflection SaO_2 sensor as shown schematically in Fig. 1.

Although the specific clinical utility of reflectance pulse

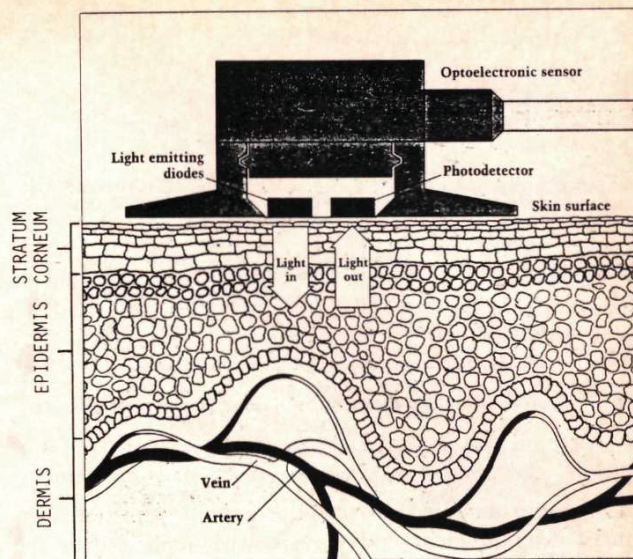

Fig. 1. Principle of reflectance pulse oximetry illustrating the optical sensor and the different layers of the skin.

oximetry has yet to be determined, it appears that the technique may have potential application for neonatal monitoring. For example, a reflectance SaO_2 sensor may be of considerable value in the assessment of fetal distress during delivery if used in addition to presently available screw-type scalp ECG electrodes. Furthermore, since the skin of the chest is supplied by branches of the internal thoracic artery, which in turn stem from blood vessels leaving the aorta above the ductus arteriosus, SaO_2 measurements using a reflectance sensor attached to the chest may prove to be of clinical importance when monitoring newborn infants with a patent ductus arteriosus.

III. METHODS

A. Instrumentation

1) *Reflectance SaO_2 Sensor:* We have constructed and tested a prototype reflectance sensor which consists of three parts: an optical sensor for monitoring SaO_2 , a feedback-controlled heater for varying the local temperature of the skin under the sensor, and a laser Doppler probe for recording relative changes in skin blood flow under the sensor.

A schematic diagram illustrating the front view of the combined sensor is shown in Fig. 2. The sensor assembly can be attached to the skin by means of a double-sided, ring-shaped, tape. This attachment technique is sufficient to maintain the sensor in place without exerting excessive pressure that could significantly reduce local blood flow in the skin.

The optical sensor for monitoring SaO_2 consists of red and infrared LED's with peak emission wavelength of 660 and 950 nm, respectively, and a silicone p-i-n photodiode. The half-power spectral bandwidth of each LED is approximately 20–30 nm. The LED's (dimensions: 0.3×0.3 mm) and photodiode (dimension: 2.0×3.0 mm)

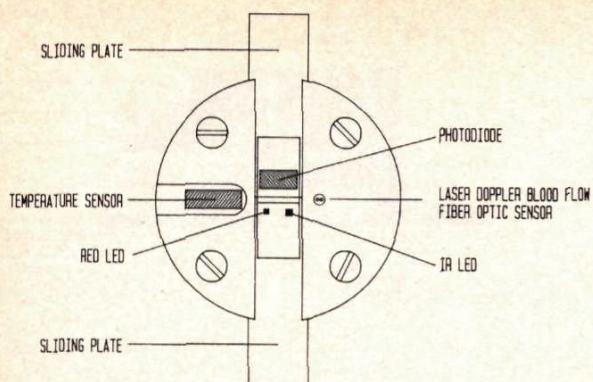

Fig. 2. Frontal view of the combined SaO_2 /laser Doppler skin blood flow sensor.

chips were mounted on separate ceramic substrates. A small drop of clear epoxy resin was applied over the LED's and photodiode for protection. For investigational purposes, the ceramic substrates containing the LED's and photodiode were mounted on separate sliding plates. This arrangement provides convenient adjustment of the separation distance between the LED's and the photodiode from 4 to 11 mm. Undesired specular light reflections from the surface of the skin, as well as direct light path between the LED's and the photodiode, were minimized by recessing and optically shielding the LED's and photodiode inside the sensor assembly.

The feedback-controlled heater consists of a round thermofoil heating element (1.25 cm diameter) and a solid-state temperature transducer (Analog Devices AD590) mounted in close proximity to the surface of the sensor contacting the skin. The heater is capable of delivering a maximum power of 2 W. The temperature of the sensor can be adjusted between 34 and 45°C in 1 +/−0.1°C steps.

The distal ends of two parallel glass optical fibers (diam. 0.15 mm; separation 0.5 mm) were used for recording relative skin blood flow under the reflectance sensor. The fiber tips were mounted in close proximity to the LED's and photodiode. The proximal ends of these optical fibers were coupled to a MEDPACIFIC Model LD 5000 Laser Doppler perfusion monitor (MEDPACIFIC Corp., Seattle, WA). A 5 mW, continuous wave, HeNe laser located inside the perfusion monitor generates a monochromatic beam of red (632.8 nm) light. This light passes to the skin through one optical fiber which illuminates a region of tissue that approximates a hemisphere with a radius of about 1 mm. The light entering the tissue is scattered by the moving red blood cells causing a frequency shift proportional to the blood flow according to the Doppler principle [10]. A portion of the backscattered light from both the nonmoving tissue structures and the moving red blood cells is then collected by an adjacent optical fiber and projected onto a photodiode inside the LD 5000 monitor. The electrical output from this photodiode is processed by the perfusion monitor resulting in a continuous reading

that is proportional to the skin blood flow under the sensor. The instrument was nulled electronically before each study by adjusting the output reading to zero after the sensor was positioned over a stationary surface of white scattering material. To avoid optical interference between the LED's in the SaO_2 sensor and the HeNe laser source, the reflectance pulse oximeter was turned off when skin blood flow measurements were performed.

2) *Reflectance Pulse Oximeter*: The reflectance oximeter generates digital switching pulses to drive the red and infrared LED's in the sensor alternately at a repetition rate of 1 KHz. The time multiplexed output current from the photodiode, which correspond to the red and infrared light intensities reflected from the skin, is first converted to a proportional analog voltage using a low noise operational amplifier configured as a current-to-voltage converter. The resulting output voltage is subsequently decomposed into two separate channels using two sample-and-hold circuits synchronously triggered by the same pulses driving the respective LED's. The red and infrared photoplethysmograms produced are amplified and high-pass filtered (cut-off frequency 15 Hz) to separate the ac pulses from the dc signal of each photoplethysmogram. To enable further signal processing, the respective ac and dc signals of each photoplethysmogram were digitized at a rate of 100 samples/s by an IBM-AT personal computer equipped with a Tecmar 12 bit resolution A/D-D/A data acquisition board. From the recorded signals, a computer algorithm calculates the $I_r(\text{red})/I_r(\text{infrared})$ ratio for each heartbeat. These values are further averaged using a five-point running average algorithm. Another algorithm uses the averaged ratios to compute and display SaO_2 according to (1). The A and B coefficients necessary for calculating SaO_2 in the oximeter were determined previously in our laboratory based on a calibration study using the HP Model 47201A ear oximeter as a reference.

B. In Vivo Studies

Seven Caucasian volunteers participated in the studies which were approved by our institutional review board. The subjects, five males and two females, were healthy nonsmokers ranging in age from 21 to 29 years.

To establish a reference for measuring SaO_2 , we used the HP 47201A ear oximeter. The oximeter was standardized before each test by placing the ear probe in a special standardization chamber inside the ear oximeter. The ear probe was then attached to the anti-helix portion of the ear pinna with a head mount and elastic head band according to the manufacturer recommendations.

The sensor of the reflectance pulse oximeter was attached either to the volar side of the forearm or the anterior thigh region. In each case, the monitored arm or leg was immobilized in the horizontal position to minimize spurious movement artifacts.

The experimental setup used in our studies is illustrated in Fig. 3.

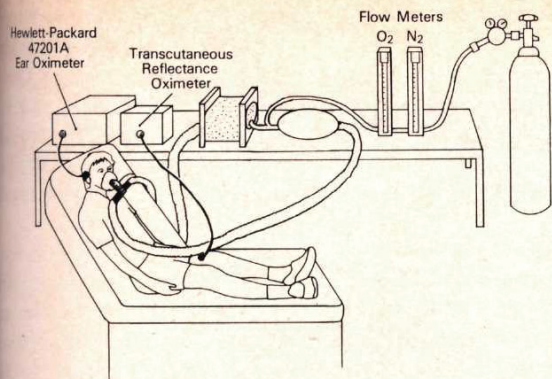

Fig. 3. Experimental setup illustrating the closed loop rebreathing circuit for obtaining different inspired O₂/N₂ concentrations and the attachment of the oximeter sensors to the subject's ear and thigh.

IV. RESULTS

Several *in vivo* studies were performed using the prototype optical reflectance sensor and oximeter as described above. The primary objectives of the first study were to investigate the effect of 1) source/detector separation and 2) local skin heating on the pulsatile component of the red and infrared photoplethysmograms detected by the sensor. In a separate *in vivo* study, we compared SaO₂ values measured by the pulse oximeter from the forearm and thigh of different subjects during progressive hypoxemia with simultaneous recordings obtained from the HP ear oximeter in the range between 70-100 percent.

A. Source/Detector Separation Studies

The purpose of these studies was to determine the relationship between different LED/photodiode separations and the magnitude of the pulsatile component of each reflection photoplethysmogram. We noticed that for a constant LED intensity, the light intensity detected by the photodiode decreases roughly exponentially as the radial distance from the LED's is increased. The same basic relationship applies to both the dc and ac components of the reflected photoplethysmograms as shown in Fig. 4. This is expected since the probability that the incident photons will be absorbed as they traverse a relatively longer path length before reaching the detector is increased.

Fig. 5 shows the relative pulse amplitude of the red and infrared reflected photoplethysmograms recorded from the forearm of one subject. In this study, the incident light intensities of the red and infrared LED's were adjusted by varying the LED driving currents such that for each separation distance the dc component of each photoplethysmogram remained relatively constant. Each point represents the average values obtained for five repeated experiments performed on the same subject. In each experiment, and for each separation distance, the data acquired were averaged over a 30 s time interval.

As shown in Fig. 5, by increasing the separation distance between the LED's and photodiode from 4 to 11

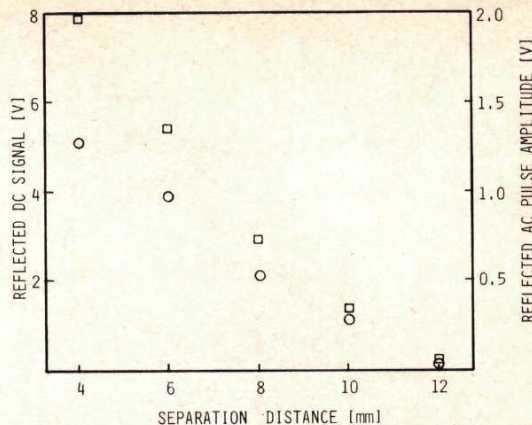

Fig. 4. The effect of LED/photodiode separation on the dc (□) and ac (○) components of the reflected infrared photoplethysmograms. Measurements were performed at a skin temperature of 43°C.

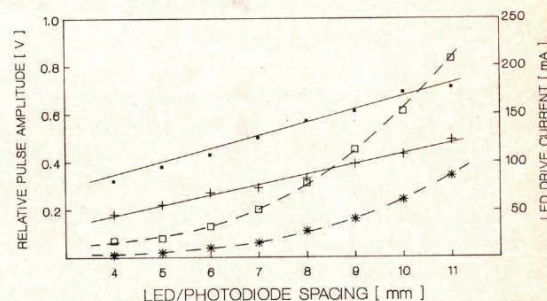

Fig. 5. Effect of LED/photodiode separation on the relative pulse amplitude of the red (+) and infrared (■) photoplethysmograms. The driving currents of the red (□) and infrared (★) LED's required to maintain a constant dc reflectance from the skin are shown for comparison.

mm, we were able to achieve almost a two-fold increase in the pulse amplitude of the infrared photoplethysmogram. Furthermore, as illustrated in Fig. 6, the mean beat-to-beat variations of the infrared photoplethysmograms, which were determined by calculating the respective coefficients of variation (i.e., the standard deviation divided by the mean for a 30 s time interval), decreased from about 7 to 3 percent. This trend indicates that the photoplethysmograms became progressively more stable as the LED/photodetector separation was increased. Similar trends were also observed for the reflected red photoplethysmograms.

B. Skin Heating Studies

Practically, it is difficult to detect large reflection photoplethysmograms from skin areas which are not very vascular, such as the chest and the limbs. In this study, we attempted to determine if local skin heating, which is known to produce vasodilatation of the microvascular bed, could be used as a practical mean to increase the pulsatile component of the reflected photoplethysmograms. Likewise, we sought to determine if skin heating could help to reduce the beat-to-beat variability in the pulsatile components of the recorded photoplethysmograms.

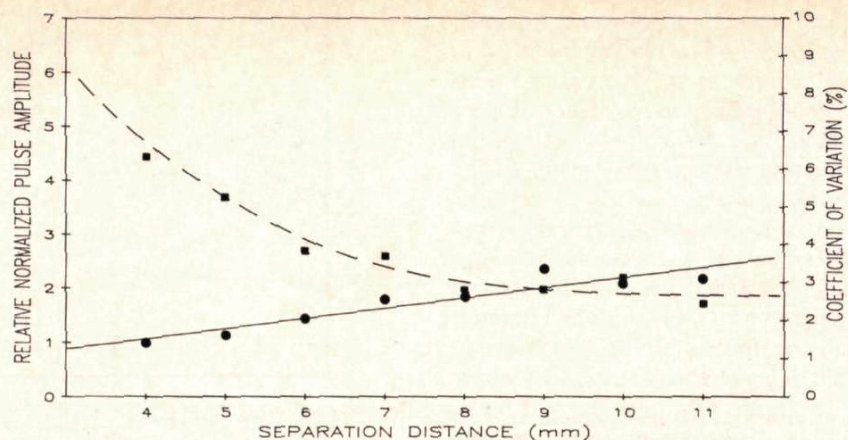

Fig. 6. Effect of LED/photodiode separation on the mean pulse amplitude (●) and the corresponding decrease in the beat-to-beat amplitude fluctuation (■) of the infrared photoplethysmograms expressed in terms of the coefficient of variation. Each pulse amplitude was normalized with respect to a separation distance of 4 mm.

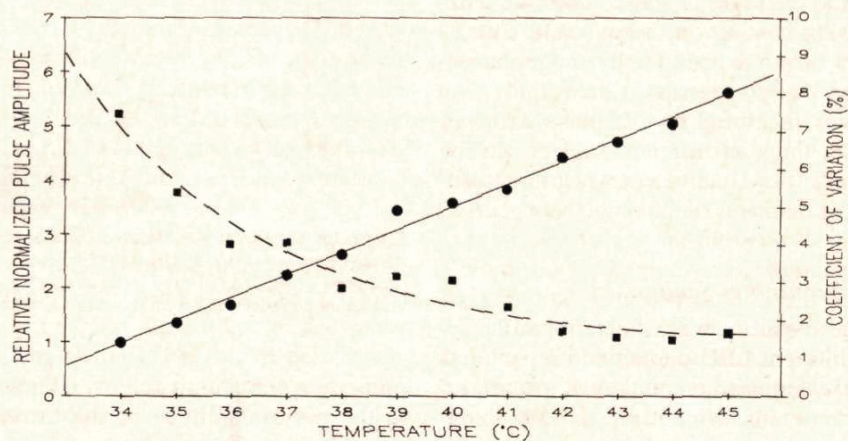

Fig. 7. Effect of skin temperature on the mean pulse amplitude (●) and the corresponding decrease in the coefficient of variation (■) of the infrared photoplethysmograms. Each pulse amplitude was normalized with respect to a separation distance of 4 mm.

Measurements were performed at a constant LED/photodiode separation of 6 mm while the subject was breathing ambient air. After attaching the reflectance sensor to the forearm, the surface of the skin was gradually heated to 45°C in 1°C step increments. The time needed to achieve a desired skin temperature depends on factors such as skin type, local blood flow, heat conductivity of the skin, and the temperature of the surrounding environment. Typically, we found that at each temperature setting, 5 min were sufficient for the skin temperature to reach steady state.

As shown in Fig. 7, by increasing the local skin temperature from 34° to 45°C, we were able to obtain a five-fold increase in the pulse amplitude of the infrared photoplethysmograms. Moreover, by heating the skin, the vascular bed under study becomes vasodilated and, there-

fore, the reflected photoplethysmograms become more stable resulting in smaller beat-to-beat amplitude fluctuations. Consequently, as our data show, the mean coefficient of variation decreased from approximately 7 to 2 percent. Similar trends were also observed for the reflected red photoplethysmograms.

The effect of local skin heating on the pulsatile component of the reflected photoplethysmograms is shown in Fig. 8. The relative skin blood flow for each temperature setting is also shown for comparison. It is clearly seen that as the temperature of the skin was increased from its initial value of 29° to 43°C, the pulse amplitude of the red and infrared photoplethysmograms increased accordingly. Furthermore, the mean pulse amplitude of the recorded waveforms remained relatively constant over a period of approximately 20 min after the heater was turned

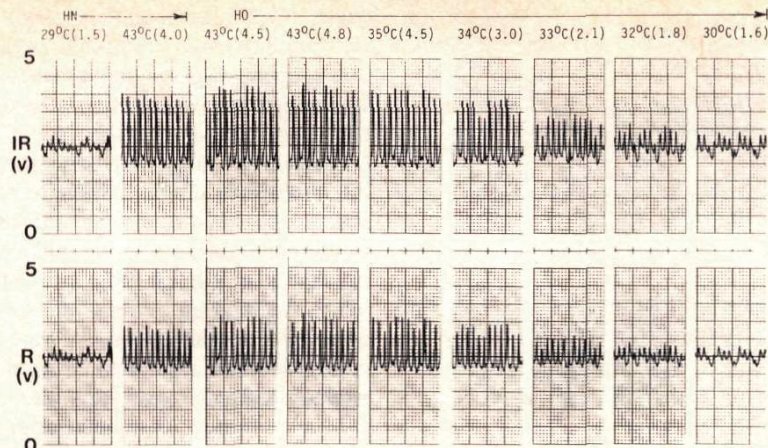

Fig. 8. Simultaneous recording of the infrared and red photoplethysmograms from the forearm at different skin temperatures. The numbers in parenthesis indicate the relative skin blood flows (scale: 0-10). Each record lasted approximately 15 s. The time elapsed between consecutive recordings is 10 min. HN = heater turned on, HO = heater turned off.

off. Thereafter, the pulse amplitude started to diminish. After about 50 min, the pulse amplitude returned to its initial level.

C. Hypoxemia Studies

Preliminary studies using our prototype reflectance sensor during progressive steady-state hypoxemia were conducted on a group of seven healthy adult volunteers.

Each subject was placed in a reclining position and asked to breathe different fractions of O₂/N₂ gas while maintaining spontaneous respiration. The inspired O₂/N₂ gas mixture was supplied through a fitted face mask by a closed-loop rebreathing circuit equipped with a CO₂ scrubber and a one-way breathing valve. The fractional inspired O₂ concentration (F_IO₂) was adjusted between 10 and 100 percent using separate gas flowmeters. The exact inspired F_IO₂ was monitored continuously with an Instrumentation Laboratory Model 408 oxygen monitor (Instrumentation Laboratories Inc., Lexington, MA) which was inserted in the inspiratory limb.

The skin reflectance sensor was attached to the volar side of the forearm and maintained at a constant temperature of 43°C. The spacing between the LED's and the photodiode in these experiments was set to 6 mm.

Initially, the F_IO₂ was changed in step decrements, each producing a 5 percent decrease in SaO₂ as measured by the reference HP ear oximeter. At each SaO₂ level, the inspired F_IO₂ was maintained at a constant level until both oximeters displayed stable readings.

For each step change in F_IO₂, SaO₂ readings from our prototype reflectance pulse oximeter were averaged over 60 s time intervals and compared to the corresponding SaO₂ values measured simultaneously by the HP ear oximeter. The averaged readings from all seven subjects were then pooled and a linear regression analysis was performed.

A comparison between the reflectance pulse oximeter and the HP ear oximeter readings obtained from all seven subjects is shown in Fig. 9. A total of 66 pairs of data points were used in this regression analysis. Linear regression analysis of this experimental data resulted in a slope of 0.93 and a positive y intercept of 6.22 percent (r = 0.96; S.E.E = 2.20). The mean and standard deviation for the differences between the skin reflectance pulse oximeter and the HP SaO₂ readings were found to be -0.001 +/- 2.27, respectively.

In order to determine if repeatable SaO₂ measurements can be made also from body sites other than the forearm, we performed a similar series of experiments in which the sensor was applied to the thigh region of three different subjects. In these experiments, a total of 24 data points were obtained simultaneously from the reflectance pulse oximeter and the HP ear oximeter. Linear regression analysis of this data set revealed a slope of 0.93 and a positive y intercept of 6.5 percent (r = 0.99; S.E.E. = 1.56). The mean and standard deviation for the differences between the skin reflectance pulse oximeter and the HP SaO₂ readings were found to be -0.001 +/- 1.61, respectively.

The response of our prototype skin reflectance oximeter was further compared against simultaneous recordings of SaO₂ from the fingertip and earlobe made by a transmission pulse oximeter (Nellcor Model N-100, Nellcor, Inc., Hayward, CA) and the HP ear oximeter, respectively. The recordings, which are shown in Fig. 10, were obtained by asking the subject to hyperventilate and then hold his breath consecutively.

D. Multiple Photodetector Arrangement

The incident light emitted from the LED's diffuses in the skin in all directions. This is evident from the circular pattern of backscattered light surrounding the LED's. Therefore, by collecting the backscattered radiation using

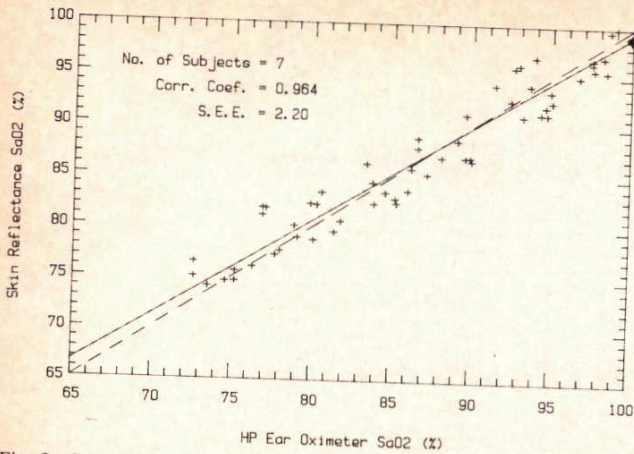

Fig. 9. Comparison of SaO_2 recorded simultaneously from the forearm and the ear by the skin reflectance pulse oximeter and the HP ear oximeter, respectively.

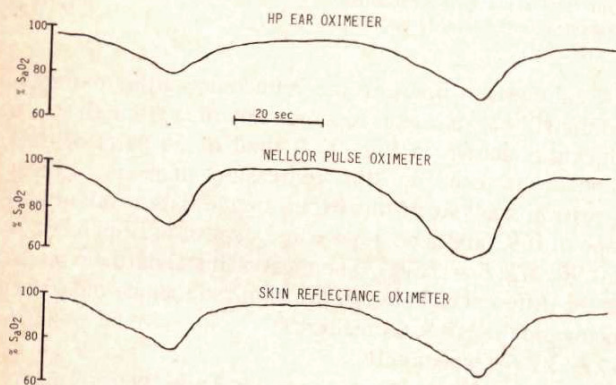

Fig. 10. Simultaneous recordings of SaO_2 from the HP ear oximeter, Nellcor pulse oximeter and the prototype reflectance pulse oximeter.

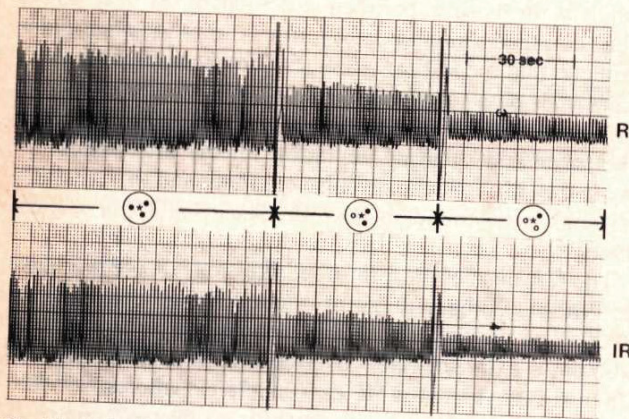

Fig. 11. Reflection photoplethysmograms recorded from the forearm using a combination of three photodiodes. The circles indicate the relative location of the photodiodes with respect to the LED's (\star). The closed circles indicate the photodiodes which were used to collect the reflected light as shown by the corresponding traces.

several photodetectors, considerably larger photoplethysmograms could be detected.

To demonstrate the advantage of using multiple pho-

todetectors instead of only one, we modified our sensor and mounted two additional photodiodes similar in size and spectral response to that used originally. This enabled us to triple the total active area of the photodetector and thus collect a greater fraction of the backscattered light from the skin. Fig. 11 shows the spatial arrangement of all three photodiodes which were mounted symmetrically with respect to the red and infrared LED's. Also shown in this figure is the relative pulse amplitude of the red and infrared photoplethysmograms recorded from the forearm when the output currents of several photodiodes were summed simultaneously. As expected, we can see that by using multiple photodetectors a larger fraction of the backscattered radiation from the skin can be collected and, therefore, larger photoplethysmograms can be recorded.

V. DISCUSSION

The sensor designed for this study enabled us to examine the effect of LED/photodiode separation distance as well as skin heating on the pulse amplitude of the photoplethysmograms detected by a reflectance pulse oximeter sensor.

One of the requirements in designing a reflectance pulse oximeter sensor is to determine the optimum separation distance between the LED's and the photodiode. Obviously, this distance should be selected such that photoplethysmograms with maximum pulsatile components could be detected. Generally, the pulsatile component of the reflected photoplethysmograms depends not only on the systolic blood pulse in the peripheral vascular bed but also on the amount of arterial blood within the illuminated tissue volume.

The selection of each LED driving current determines the effective penetration depth of the incident light. For a given LED/photodiode separation, it is clear that with higher levels of incident light, a larger pulsatile vascular bed will be illuminated. Consequently, the reflected photoplethysmograms will contain a larger ac component. Practical considerations, however, limit the driving current of each LED to the manufacturer specified maximum power dissipation. Alternatively, by placing the photodetector too close to the LED's, the large dc component, which is mainly due to multiple scattering of the incident photons by the blood-free stratum corneum and epidermis layers in the skin, will cause the photodetector to become saturated.

It is important to point out that although the HP ear oximeter which was used as a reference in our studies is not an acceptable primary standard for measuring SaO_2 , its accuracy and reliability as a noninvasive oximeter have been widely established [11]–[13].

Our experience using the prototype reflectance sensor has shown that the pulse amplitude of the reflection photoplethysmograms depends among other factors on the position of the photodiode relative to the LED's. The selection of a particular separation distance, however, involves a tradeoff. On one hand, larger photoplethysmograms can be detected by mounting the photodiode further

apart from the LED's. On the other hand, higher LED driving currents are necessary to overcome the absorption of the incident light due to a longer optical path length.

The results of our studies also validated our hypothesis that skin heating is a feasible method for increasing the size of the reflected photoplethysmograms. We noticed that by heating the skin surface to 45°C, a five-fold increase in the pulsatile component could be achieved. We noticed also that the improvement due to skin heating can last up to 20 min from the time the temperature of the skin has reached 45°C and the heater was turned off. It is important to mention that the ability to measure accurate SaO₂ values by the prototype pulse oximeter sensor was independent of the exact skin temperature. We found that a minimum skin temperature of approximately 40°C is generally sufficient in order to detect adequate stable photoplethysmograms. Our experience in healthy adults has shown that at this temperature the heated sensor can remain in the same location for at least three hours without any apparent skin damage. It should be noted also that the principal objective of skin heating in our specific application is not to increase oxygen diffusion through the skin as in transcutaneous pO₂ monitoring although the vasodilatation effect of the applied heat on the vascular bed in the skin is basically the same.

The close correlation obtained between the prototype reflectance pulse oximeter, the HP ear oximeter and the Nellcor finger pulse oximeter is encouraging. We showed that the technique is sensitive and permits real time monitoring of SaO₂ from skin areas such as the forearm and the thigh. Further work, however, is needed in order to compare our reflectance pulse oximeter against SaO₂ measured directly from arterial blood samples and establish the potential of this technique in various clinical applications.

REFERENCES

- [1] R. Brinkman and W. G. Zijlstra, "Determination and continuous registration of the percentage oxygen saturation in clinical conditions," *Arch. Chir. Neurol.*, vol. 1, pp. 177-183, 1949.
- [2] A. Cohen and N. Wadsworth, "A light emitting diode skin reflectance oximeter," *Med. Biol. Eng. Comput.*, vol. 10, pp. 385-391, 1972.
- [3] S. Takatani, "On the theory and development of a noninvasive tissue reflectance oximeter," Ph.D. dissertation, Dep. Biomed. Eng., Case Western Reserve Univ., Cleveland, OH, 1978.
- [4] Y. Mendelson, "Theory and development of a transcutaneous reflectance oximeter system for noninvasive measurements of arterial oxygen saturation," Ph.D. dissertation, Dep. Biomed. Eng., Case Western Reserve Univ., Cleveland, OH, 1983.
- [5] Y. Mendelson, P. W. Cheung, M. R. Neuman, D. G. Fleming, and S. D. Cahn, "Spectrophotometric investigation of pulsatile blood flow for transcutaneous reflectance oximetry," presented at Proc. 5th Int. Symp. on Oxygen Transport to Tissue, 1981; also in *Advances Experimental Medicine Biology.*, H. I. Bicher and D. F. Bruley, Eds., vol. 159, 1983, pp. 93-102.

- [6] T. Aoyagi, M. Kishi, K. Yamaguchi, and S. Watanabe, "Improvement of the earpiece oximeter," in *Proc. Abstracts 13th Ann. Meet. Japanese Soc. Med. Electron. Biologic Eng.*, 1974, Japan, pp. 90-91.
- [7] S. Nakajima, Y. Hirai, H. Takase, A. Kuse, S. Aoyagi, M. Kishi, and K. Yamaguchi, "New pulse-type ear oximeter," *Kokyu to Junkan*, vol. 23, pp. 709-713, 1975 [Japan].
- [8] I. Yoshiya, Y. Shimada, and K. Tanaka, "Spectrophotometric monitoring of arterial oxygen saturation on the fingertip," *Med. Biol. Eng. Comput.*, vol. 18, pp. 27-32, 1980.
- [9] E. B. Merrick and T. J. Hayes, "Continuous, noninvasive measurements of arterial blood oxygen levels," *Hewlett-Packard J.*, vol. 28, no. 2, pp. 2-9, 1976.
- [10] G. A. Holloway, "Laser Doppler measurement of cutaneous blood flow," in *Non-Invasive Physiological Measurements*, vol. II, P. Rolfe, Ed. New York: Academic, 1983.
- [11] M. R. Flick and A. J. Block, "In vivo continuous arterial oxygen saturation measurement by oximetry," *Amer. Rev. Respir. Dis.*, vol. 113, p. 126, 1976.
- [12] N. A. Saunders, A. C. P. Powles, and A. S. Rebeck, "Ear oximetry: Accuracy and practicability in the assessment of arterial oxygenation," *Amer. Rev. Respir. Dis.*, vol. 113, p. 745, 1976.
- [13] N. J. Douglas, H. M. Brash, P. K. Wraith, P. M. A. Calverley, R. J. E. Leggett, L. McElderry, and D. C. Flenley, "Accuracy, sensitivity to carboxyhemoglobin, and speed of response of the Hewlett-Packard 47201A ear oximeter," *Amer. Rev. Respir. Dis.*, vol. 119, pp. 311-313, 1979.



Yitzhak Mendelson (S'79-M'82) was born in Tel-Aviv, Israel, in 1949. He received the B.S. and M.S. degrees in electrical engineering from the State University of New York, Buffalo, in 1975 and 1976, respectively, and the Ph.D. degree in biomedical engineering from Case Western Reserve University, Cleveland, OH, in 1983.

He is currently an Assistant Professor of Biomedical Engineering at Worcester Polytechnic Institute, Worcester, MA. His research interests are in developing invasive and noninvasive techniques for blood gas measurements, biomedical sensors, microprocessor-based medical instrumentation, and the study of light interaction with biological media.

Dr. Mendelson is a member of the Biomedical Engineering Society, AAMI, and the Optical Society of America.



Burt D. Ochs (S'80-M'86) was born in the Bronx, NY, in 1957. He received the A.A.S. degree in electrical technology from Westchester Community College, NY, in 1981, the B.S.E.E. degree from Boston University, Boston, MA, in 1983 and is currently completing the M.S. degree in biomedical engineering at Worcester Polytechnic Institute, Worcester, MA.

In 1986 he joined ABIOMED, Inc., Danvers, MA, as a Senior Electrical Engineer in research and development. He is currently involved in total artificial heart research and dental diagnostic instrumentation.

Now with
online-compatible
subject headings!



COVERAGE

The 1987 Index is all you need to access all of the technical publications of the IEEE, the world's leading source of information in electrical/electronics/computer science and engineering. In two volumes, the 1987 Index quickly provides you with references to all IEEE-published papers, articles, and other communications, which in 1987 totaled over 148,000 pages. Included are:

- Technical Periodicals Papers
- Conference Papers
- IEEE PRESS Books
- Technical Items from IEEE Magazines
- IEEE and ANSI/IEEE Standards
- Tutorials and Special Publications

STRUCTURE

Important information on complete publications—everything you need to fully identify and order IEEE conference records, standards etc.—is summarized in extensive listings of Indexed Publications (Volume 1). Information about individual papers is accessible by both author (Volume 1), and subject (Volume 2).

The Subject Index Headings List has been revised for 1987 to take into account the increasing use of online databases. The new set of subject headings closely parallels the controlled-vocabulary terms applied by INSPEC to all the abstracts in its database, which covers the world-wide technical literature in IEEE's subject areas. This will greatly simplify the task of finding other articles on topics that interest you.

The 1987 Index to IEEE Publications

There is simply no substitute for the aware professional requiring detailed information in electrical science and engineering.

ACCESS OVER 60,000 PERIODICAL PAGES

The 1987 Index to IEEE Publications allows you quick access to highly cited, high-impact journals covering over 45 fields of specialization, such as biomedicine... geoscience... nuclear and plasma science... pattern analysis... magnetics... computer graphics. In 1987, published materials totaled over 60,000 pages.

ACCESS OVER 85,000 NONPERIODICAL PAGES

The Index also cites all published papers presented at over 150 major IEEE-sponsored conferences held worldwide during the year—PLUS all new IEEE and ANSI/IEEE Standards, IEEE PRESS books and various other IEEE non-periodicals. In 1987, IEEE's book publishing program accounted for over 85,000 pages.

LISTS OVER 24,000 TECHNICAL ITEMS— CONTAINS OVER 200,000 ENTRIES HELPS YOU PLAN YOUR ONLINE SEARCH STRATEGY

Our annual Index is the only index that covers the totality of IEEE technical publishing.

Year	Order Number	List Price	IEEE/AIP Member Price
1987	JH88534	\$245.00	\$150.00
1986	JH83352	\$220.00	\$120.00
1985	JH78287	\$200.00	\$100.00
1984	JH73411	\$200.00	\$100.00
1983	JH68916	\$190.00	\$100.00

To order the Index to IEEE Publications, please give title, year, order number, and price. You may charge your order to VISA, MasterCard/Eurocard, Diners Club, or American Express. (Be sure to include card name, number, and expiration date.) Shipping and handling charges: For orders totaling \$75.01 to \$100.00 add \$6.00; \$100.01 to \$200.00 add \$8.00; over \$200.00 add \$15.00. New Jersey residents, please add 6% sales tax. Mail your order to:

IEEE SERVICE CENTER, Publications Sales
P.O. Box 1331, 445 Hoes Lane, Piscataway, NJ 08855-1331
Invoice Orders: (201) 981-1393. Credit Card Orders: (201) 981-9535



The Institute of Electrical and
Electronics Engineers, Inc.

MENDELSON02

The CATALOG

Connecting Public Libraries in Allegheny County, PA

Your Library	Tips & Resources	Booklists	Find Articles	Interlibrary Loan	Get a Library Card
------------------------------	--------------------------------------	---------------------------	-------------------------------	-----------------------------------	------------------------------------

```

LEADER 00000cas 2200000 a 4500
001 1752544
003 OCoLC
005 20150414134057.0
007 cr unu|||||||
008 751101c19649999nyumr p 0 a0eng
010 57058289
016 7 I03620000|2DNLM
019 185059399
022 0 0018-9294|21
030 IEBEAX
032 815900|BUSPS
035 (OCoLC)1752544|z(OCoLC)185059399
040 DLC|cMUL|dNSD|dYUS|dOCL|dNSD|dHUL|dSER|dRCS|dNSD|dAIP|dDLC
|dAIP|dDLC|dAIP|dNSD|dNST|dNSD|dNST|dMXC|dMYG|dCUS|dOCL
|dMYG|dLYU|dIEEEX|dOCLCQ|dNSD|dNLGGC|dLVB|dUOrBLW
042 nsdp|alc
049 CPL
050 00 R895.A1|bI25
082 04 610/.28|219
210 0 IEEE trans. biomed. eng.|b(Print)
222 0 IEEE transactions on biomedical engineering|b(Print)
245 00 IEEE transactions on bio-medical engineering /|cBio-
medical Engineering Group.
246 3 Institute of Electrical and Electronics Engineers
transactions on bio-medical engineering
246 30 IEEE transactions on biomedical engineering
246 30 Transactions on bio-medical engineering
260 New York, N.Y. :|bInstitute of Electrical and Electronics
Engineers,|c@1964-
300 volumes :|billustrations, portraits ;|c28 cm
310 Monthly|b<, Jan. 1979- >
321 Bimonthly|b<, Nov. 1975- >
321 Quarterly,|b1964-<Jan. 1969>
336 text|btxt|2rdacontent
337 unmediated|bn|2rdamedia
338 volume|bnc|2rdacarrier
362 0 Vol. BME-11, no. 1 & 2 (Jan./Apr. 1964)-
510 2 Chemical abstracts|x0009-2258|b1864-1982
530 Also issued online.
550 Vols. for 1964-Oct. 1964 issued by the Bio-medical
Engineering Group of the IEEE; Jan. 1965-<Nov. 1975> by
the IEEE Engineering in Medicine and Biology Group; <,
Jan. 1979- > by the IEEE Engineering in Medicine and
Biology Society.
650 0 Biomedical engineering|vPeriodicals.
650 0 Medical electronics|vPeriodicals.
650 0 Medical physics|vPeriodicals.
710 2 Institute of Electrical and Electronics Engineers.|bBio-
medical Engineering Group.
710 2 IEEE Engineering in Medicine and Biology Group.
710 2 IEEE Engineering in Medicine and Biology Society.
776 1 |tIEEE transactions on biomedical engineering (Online)
|x1558-2531|w(DLC) 2005215246|w(OCoLC)44459946
780 00 |tIEEE transactions on bio-medical electronics|x0096-0616
|w(DLC)sf 84001208|w(OCoLC)1642035
856 41 |uhttps://ieeexplore.ieee.org/servlet/opac?punumber=10
891 20 |9853|81|av.|bno.|u12|vr|i(year)|j(month)|wm
891 41 |9863|81.1|a<49>|b<1>|i<2002>|j<01>
994 C0|bCPL
    
```

Location	Carnegie Library of Pittsburgh - Off Site Storage (Please ask for assistance)
Lib Has	Volume 11 (1964) to Volume 14 (1967).
Location	CLP Main (Oakland) Second Floor - Magazines
Lib Has	Volume 15 (1968) to volume 56, no. 3 (2009).



- Your Library
- Tips & Resources
- Booklists
- Find Articles
- Interlibrary Loan
- Get a Library Card

CONTROL NO

Show available items only

(Search History)

Record:

Title	IEEE transactions on bio-medical engineering / Bio-medical Engineering Group.
Publisher	New York, N.Y. : Institute of Electrical and Electronics Engineers, ©1964-
Description	volumes : illustrations, portraits ; 28 cm
Frequency	Monthly <, Jan. 1979- > Bimonthly <, Nov. 1975- > Quarterly, 1964-<Jan. 1969>
Pub Date	Vol. BME-11, no. 1 & 2 (Jan./Apr. 1964)-

Links:

[Connect to https://ieeexplore.ieee.org/servlet/opac?punumber=10](https://ieeexplore.ieee.org/servlet/opac?punumber=10)

<i>Location</i>	Carnegie Library of Pittsburgh - Off Site Storage (Please ask for assistance)
<i>Lib Has</i>	Volume 11 (1964) to Volume 14 (1967).
<i>Location</i>	CLP Main (Oakland) Second Floor - Magazines
<i>Lib Has</i>	Volume 15 (1968) to volume 56, no. 3 (2009).

Details

Indexed In:	Chemical abstracts 0009-2258 1864-1982
Note	Also issued online.
Issued By	Vols. for 1964-Oct. 1964 issued by the Bio-medical Engineering Group of the IEEE; Jan. 1965-<Nov. 1975> by the IEEE Engineering in Medicine and Biology Group; <, Jan. 1979- > by the IEEE Engineering in Medicine and Biology Society.
Subject	Biomedical engineering -- Periodicals. Medical electronics -- Periodicals. Medical physics -- Periodicals.
Add'l Author	Institute of Electrical and Electronics Engineers. Bio-medical Engineering Group. IEEE Engineering in Medicine and Biology Group. IEEE Engineering in Medicine and Biology Society.
Key Title	IEEE trans. biomed. eng. (Print) IEEE transactions on biomedical engineering (Print)
Alt Title	Institute of Electrical and Electronics Engineers transactions on bio-medical engineering IEEE transactions on biomedical engineering Transactions on bio-medical engineering
Continues	IEEE transactions on bio-medical electronics
Related To	IEEE transactions on biomedical engineering (Online) 1558-2531 (DLC) 2005215246 (OCoLC)44459946
ISSN	0018-9294

IEEE03

APPENDIX IEEE03



DECLARATION OF GORDON MACPHERSON

I, Gordon MacPherson, am over twenty-one (21) years of age. I have never been convicted of a felony, and I am fully competent to make this declaration. I declare the following to be true to the best of my knowledge, information and belief:

1. I am Director Board Governance & IP Operations of The Institute of Electrical and Electronics Engineers, Incorporated (“IEEE”).
2. IEEE is a neutral third party in this dispute.
3. I am not being compensated for this declaration and IEEE is only being reimbursed for the cost of the article I am certifying.
4. Among my responsibilities as Director Board Governance & IP Operations, I act as a custodian of certain records for IEEE.
5. I make this declaration based on my personal knowledge and information contained in the business records of IEEE.
6. As part of its ordinary course of business, IEEE publishes and makes available technical articles and standards. These publications are made available for public download through the IEEE digital library, IEEE Xplore.
7. It is the regular practice of IEEE to publish articles and other writings including article abstracts and make them available to the public through IEEE Xplore. IEEE maintains copies of publications in the ordinary course of its regularly conducted activities.
8. The article below has been attached as Exhibit A to this declaration:

A.	Y. Mendelson and B.D. Ochs, “Noninvasive pulse oximetry utilizing skin reflectance photoplethysmography”, IEEE Transactions on Biomedical Engineering, Vol. 35, Issue 10, October 1988.
----	---

9. I obtained a copy of Exhibit A through IEEE Xplore, where it is maintained in the ordinary course of IEEE’s business. Exhibit A is a true and correct copy of the Exhibit, as it existed on or about April 30, 2021.
10. The article and abstract from IEEE Xplore show the date of publication. IEEE Xplore populates this information using the metadata associated with the publication.

11. Y. Mendelson and B.D. Ochs, "Noninvasive pulse oximetry utilizing skin reflectance photoplethysmography" was published in IEEE Transactions on Biomedical Engineering, Vol. 35, Issue: 10. IEEE Transactions on Biomedical Engineering, Vol. 35, Issue: 10 was published in October 1988. Copies of this publication was made available no later than the last day of the publication month. The article is currently available for public download from the IEEE digital library, IEEE Xplore.
12. I hereby declare that all statements made herein of my own knowledge are true and that all statements made on information and belief are believed to be true, and further that these statements were made with the knowledge that willful false statements and the like are punishable by fine or imprisonment, or both, under 18 U.S.C. § 1001.

I declare under penalty of perjury that the foregoing statements are true and correct.

Executed on: 5/3/2021

DocuSigned by:
Gordon Macpherson
E768DB210F4E4EF...

DocuSign Envelope ID: 3595DB4B-1765-4589-8185-7AD82F0E2BC1

EXHIBIT A



Institutional Sign In

All



ADVANCED SEARCH

Journals & Magazines > IEEE Transactions on Biomedic... > Volume: 35 Issue: 10

[Back to Results](#)

Noninvasive pulse oximetry utilizing skin reflectance photoplethysmography

Publisher: IEEE

[Cite This](#)

PDF

<< Results

Y. Mendelson ; B.D. Ochs **All Authors**

105
Paper
Citations

38
Patent
Citations

2478
Full
Text Views



Export to

Collabratec

Alerts

Manage

Content Alerts

Add to Citation

Alerts

More Like This

Effect of Pressure on Skin-Electrode Impedance in Wearable Biomedical Measurement Devices
IEEE Transactions on Instrumentation and Measurement
Published: 2018

Developing a skin conductance device for early Autism Spectrum Disorder diagnosis
2016 3rd Middle East Conference on Biomedical Engineering (MECBME)
Published: 2016

[Show More](#)

Abstract

Authors

Downl
PDF

References

Citations

Keywords

Metrics

More Like This

Abstract:The major concern in developing a sensor for reflectance pulse oximetry is the ability to measure large and stable photoplethysmograms from light which is backscattered f... [View more](#)

Metadata

Abstract:

The major concern in developing a sensor for reflectance pulse oximetry is the ability to measure large and stable photoplethysmograms from light which is backscattered from the skin. Utilizing a prototype optical reflectance sensor, locally heating the skin is shown to increase the pulsatile component of the reflected photoplethysmograms. Additional improvements to signal-to-noise ratio were achieved by increasing the active area of the photodetector and optimizing the separation distance between the light source and photodetector. The results from a series of in vivo studies to evaluate a prototype skin-reflectance pulse oximeter in humans are presented.< >

Published in: IEEE Transactions on Biomedical Engineering (Volume: 35 , Issue: 10, Oct. 1988)

Page(s): 798 - 805

INSPEC Accession Number: 3300017

Date of Publication: Oct. 1988

DOI: 10.1109/10.7286

ISSN Information:

Publisher: IEEE

PubMed ID: 3192229

Y. Mendelson

Biomedical Engineering Program, Worcester Polytechnic Institute, Worcester, MA, USA

B.D. Ochs

Biomedical Engineering Program, Worcester Polytechnic Institute, Worcester, MA, USA

Authors

Y. Mendelson

Biomedical Engineering Program, Worcester Polytechnic Institute, Worcester, MA, USA

B.D. Ochs

Biomedical Engineering Program, Worcester Polytechnic Institute, Worcester, MA, USA

References

Citations

Keywords

Metrics

IEEE Personal Account

CHANGE USERNAME/PASSWORD

Purchase Details

PAYMENT OPTIONS

VIEW PURCHASED DOCUMENTS

Profile Information

COMMUNICATIONS PREFERENCES

PROFESSION AND EDUCATION

TECHNICAL INTERESTS

Need Help?

US & CANADA: +1 800 678 4333

WORLDWIDE: +1 732 981 0060

CONTACT & SUPPORT

Follow



About IEEE Xplore | Contact Us | Help | Accessibility | Terms of Use | Nondiscrimination Policy | Sitemap | Privacy & Opting Out of Cookies

A not-for-profit organization, IEEE is the world's largest technical professional organization dedicated to advancing technology for the benefit of humanity.

© Copyright 2021 IEEE - All rights reserved. Use of this web site signifies your agreement to the terms and conditions.

IEEE Account

» Change Username/Password

» Update Address

Purchase Details

» Payment Options

» Order History

» View Purchased Documents

Profile Information

» Communications Preferences

» Profession and Education

» Technical Interests

Need Help?

» US & Canada: +1 800 678 4333

» Worldwide: +1 732 981 0060

» Contact & Support

About IEEE Xplore | Contact Us | Help | Accessibility | Terms of Use | Nondiscrimination Policy | Sitemap | Privacy & Opting Out of Cookies

A not-for-profit organization, IEEE is the world's largest technical professional organization dedicated to advancing technology for the benefit of humanity.

© Copyright 2021 IEEE - All rights reserved. Use of this web site signifies your agreement to the terms and conditions.

Noninvasive Pulse Oximetry Utilizing Skin Reflectance Photoplethysmography

YITZHAK MENDELSON, MEMBER IEEE, AND BURT D. OCHS, MEMBER IEEE

Abstract—The major concern in developing a sensor for reflectance pulse oximetry is the ability to measure large and stable photoplethysmograms from light which is backscattered from the skin. Utilizing a prototype optical reflectance sensor, we showed that by locally heating the skin it is possible to increase the pulsatile component of the reflected photoplethysmograms. Furthermore, we showed that additional improvements in signal-to-noise ratio can be achieved by increasing the active area of the photodetector and optimizing the separation distance between the light source and photodetector. The results from a series of *in vivo* studies to evaluate a prototype skin reflectance pulse oximeter in humans are presented.

I. INTRODUCTION

NONINVASIVE monitoring of arterial hemoglobin oxygen saturation (SaO_2) based upon skin reflectance spectrophotometry was first described by Brinkman and Zijlstra in 1949 [1]. They showed that changes in SaO_2 can be recorded noninvasively from an optical sensor attached to the forehead. Their innovative idea to use light reflection instead of tissue transillumination, which is limited mainly to the finger tips and ear lobes, was suggested as an improvement to enable noninvasive monitoring of SaO_2 from virtually any skin surface. More recent attempts to develop a skin reflectance oximeter utilizing a similar spectrophotometric approach were made by Cohen *et al.* [2] and Takatani [3]. All of those three noninvasive reflectance oximeters attempted to monitor SaO_2 by measuring the absolute light intensity diffusely reflected (backscattered) from the skin.

While those developments represent significant advancements in noninvasive reflectance oximetry, limited accuracy as well as difficulties in absolute calibration were major problems with early reflectance oximeters. Although various methods have been proposed, to date, a versatile noninvasive reflectance oximeter, which can monitor SaO_2 reliably from any location on the skin surface, is not yet available.

Backscattered light from living skin depends not only on the optical absorption spectrum of the blood but also on the structure and pigmentation of the skin. In an attempt to overcome this problem, Mendelson *et al.* [4]

proposed to measure SaO_2 based on the principle of skin reflection photoplethysmography. We showed that SaO_2 can be measured noninvasively by analyzing the pulsatile rather than the absolute, reflected light intensity I_r of the respective red and infrared photoplethysmograms according to the following empirical relationship [4]–[5]:

$$\text{SaO}_2 = A - B [I_r(\text{red})/I_r(\text{infrared})] \quad (1)$$

where A and B are empirically derived constants which are determined statistically during *in vivo* calibration in which the $I_r(\text{red})/I_r(\text{infrared})$ ratio calculated by the pulse oximeter is compared against direct blood SaO_2 measurements. I_r is obtained by a normalization process in which the pulsatile (ac) component of the red and infrared photoplethysmograms is divided by the corresponding nonpulsatile (dc) component.

In clinical applications where presently available transmission pulse oximeters cannot be used, there is a need for an optical sensor which is suitable for monitoring SaO_2 utilizing light reflection from the skin. Although the principles of reflection and transmission pulse oximetry are very similar, the major limitation of reflection pulse oximetry is the comparatively low level photoplethysmograms typically recorded from the skin. The feasibility of reflection pulse oximetry, therefore, is highly dependent on the ability to detect sufficiently strong reflection photoplethysmograms.

This paper describes the considerations in designing a skin reflectance sensor for noninvasive monitoring of SaO_2 . The ability to detect improved photoplethysmographic waveforms through the use of skin heating and multiple photodetectors are discussed. Results from a series of *in vivo* studies to evaluate a prototype skin reflectance pulse oximeter in humans are presented.

II. BACKGROUND

A. Principle of Pulse Oximetry

Pulse oximetry has been invented by Aoyagi *et al.* [6] and further refined by Nakajima *et al.* [7] and Yoshiya *et al.* [8]. This unique approach is based on the assumption that the change in light absorbed by tissue during systole is caused primarily by the arterial blood. Consequently, they showed that changes in light transmission through a pulsating vascular bed can be used to obtain an accurate noninvasive measurement of SaO_2 .

The main advantage of employing a photoplethysmo-

Manuscript received June 17, 1987; revised May 9, 1988. This work was supported by the Whitaker Foundation and the National Science Foundation under Grant ECS-8404397.

The authors are with the Biomedical Engineering Program, Worcester Polytechnic Institute, Worcester, MA 01609.
IEEE Log Number 8822615.

0018-9294/88/1000-0798\$01.00 © 1988 IEEE

graphic technique is that only two wavelengths are required, thereby greatly simplifying the optical sensor. Furthermore, the requirement for blood "arterialization" which was essential in previous nonpulsatile oximeters, such as the eight wavelength Hewlett-Packard (HP) ear oximeter [9], has been eliminated. Hence, there is no need for continuous skin heating. Moreover, skin pigmentation, which can cause variable light attenuation, does not seem to affect the accuracy of pulse oximeters. This is because the ratio of the transmitted red/infrared light intensity, from which SaO_2 is calculated, is obtained by a normalization process in which the ac component of the red and infrared photoplethysmograms is divided by the corresponding dc components.

The basic optical sensor of a noninvasive pulse oximeter consists of a red and infrared light emitting diodes (LED's) and a silicone photodiode. The wavelength of the red LED is typically chosen from regions of the spectra where the absorption coefficient of Hb and HbO_2 are markedly different (e.g., 660 nm). The infrared wavelength, on the other hand, is typically chosen from the spectral region between 940 and 960 nm where the difference in the absorption coefficients of Hb and HbO_2 is relatively small. The photodiode used has a broad spectral response that overlaps the emission spectra of the red and infrared LED's.

The light intensity detected by the photodetector depends, apart from the intensity of the incident light, mainly on the opacity of the skin, reflection by bones, tissue scattering, and the amount of blood present in the vascular bed. The amount of light attenuated by the blood varies according to the pumping action of the heart. Consequently, as tissue blood volume increases during systole, a greater portion of the incident light is absorbed by the arterial blood causing a rapidly alternating signal. Depending on the physiological state of the microvascular bed, typically, these alternating light intensity amounts to approximately 0.05–1 percent of the total light intensity either transmitted through or backscattered from the skin.

Since pulse oximeters rely on the detection of arterial pulsation, significant reduction in peripheral blood flow, such as in hypotension or hypothermia, can limit the reliability of the measurement. Nevertheless, the fact that no user calibration or site preparation is required, and the availability of small, light weight, and easy to apply sensors has made transmission pulse oximeters very popular in various clinical applications.

B. Reflection Versus Transmission Pulse Oximetry

In transmission pulse oximetry, sensor application is obviously limited to areas of the body, such as the finger tips, ear lobes, toes, and in infants the foot or palms where transmitted light can be readily detected. Other locations, which are not accessible to conventional transillumination techniques, i.e., the limbs, forehead, and chest may be monitored in principle using a reflection SaO_2 sensor as shown schematically in Fig. 1.

Although the specific clinical utility of reflectance pulse

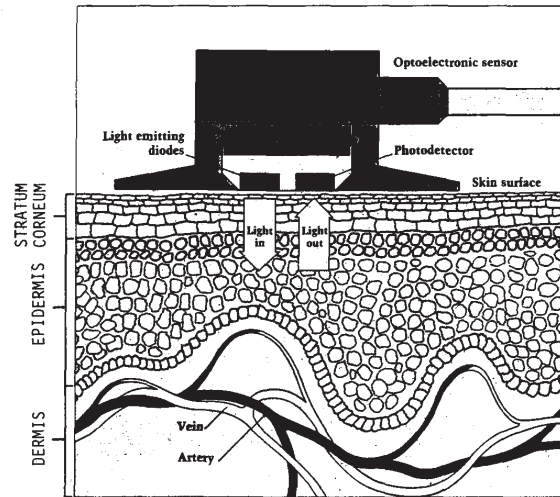

Fig. 1. Principle of reflectance pulse oximetry illustrating the optical sensor and the different layers of the skin.

oximetry has yet to be determined, it appears that the technique may have potential application for neonatal monitoring. For example, a reflectance SaO_2 sensor may be of considerable value in the assessment of fetal distress during delivery if used in addition to presently available screw-type scalp ECG electrodes. Furthermore, since the skin of the chest is supplied by branches of the internal thoracic artery, which in turn stem from blood vessels leaving the aorta above the ductus arteriosus, SaO_2 measurements using a reflectance sensor attached to the chest may prove to be of clinical importance when monitoring newborn infants with a patent ductus arteriosus.

III. METHODS

A. Instrumentation

1) *Reflectance SaO_2 Sensor:* We have constructed and tested a prototype reflectance sensor which consists of three parts: an optical sensor for monitoring SaO_2 , a feedback-controlled heater for varying the local temperature of the skin under the sensor, and a laser Doppler probe for recording relative changes in skin blood flow under the sensor.

A schematic diagram illustrating the front view of the combined sensor is shown in Fig. 2. The sensor assembly can be attached to the skin by means of a double-sided, ring-shaped, tape. This attachment technique is sufficient to maintain the sensor in place without exerting excessive pressure that could significantly reduce local blood flow in the skin.

The optical sensor for monitoring SaO_2 consists of red and infrared LED's with peak emission wavelength of 660 and 950 nm, respectively, and a silicone p-i-n photodiode. The half-power spectral bandwidth of each LED is approximately 20–30 nm. The LED's (dimensions: 0.3×0.3 mm) and photodiode (dimension: 2.0×3.0 mm)

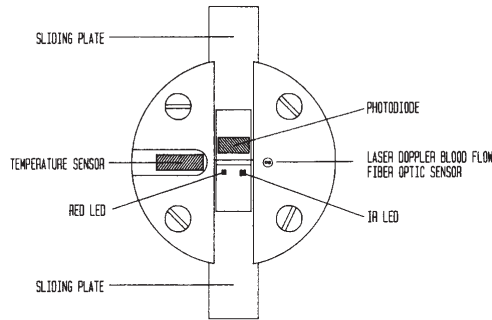

Fig. 2. Frontal view of the combined SaO_2 /laser Doppler skin blood flow sensor.

chips were mounted on separate ceramic substrates. A small drop of clear epoxy resin was applied over the LED's and photodiode for protection. For investigational purposes, the ceramic substrates containing the LED's and photodiode were mounted on separate sliding plates. This arrangement provides convenient adjustment of the separation distance between the LED's and the photodiode from 4 to 11 mm. Undesired specular light reflections from the surface of the skin, as well as direct light path between the LED's and the photodiode, were minimized by recessing and optically shielding the LED's and photodiode inside the sensor assembly.

The feedback-controlled heater consists of a round thermofoil heating element (1.25 cm diameter) and a solid-state temperature transducer (Analog Devices AD590) mounted in close proximity to the surface of the sensor contacting the skin. The heater is capable of delivering a maximum power of 2 W. The temperature of the sensor can be adjusted between 34 and 45°C in 1 +/−0.1°C steps.

The distal ends of two parallel glass optical fibers (diam. 0.15 mm; separation 0.5 mm) were used for recording relative skin blood flow under the reflectance sensor. The fiber tips were mounted in close proximity to the LED's and photodiode. The proximal ends of these optical fibers were coupled to a MEDPACIFIC Model LD 5000 Laser Doppler perfusion monitor (MEDPACIFIC Corp., Seattle, WA). A 5 mW, continuous wave, HeNe laser located inside the perfusion monitor generates a monochromatic beam of red (632.8 nm) light. This light passes to the skin through one optical fiber which illuminates a region of tissue that approximates a hemisphere with a radius of about 1 mm. The light entering the tissue is scattered by the moving red blood cells causing a frequency shift proportional to the blood flow according to the Doppler principle [10]. A portion of the backscattered light from both the nonmoving tissue structures and the moving red blood cells is then collected by an adjacent optical fiber and projected onto a photodiode inside the LD 5000 monitor. The electrical output from this photodiode is processed by the perfusion monitor resulting in a continuous reading

that is proportional to the skin blood flow under the sensor. The instrument was nulled electronically before each study by adjusting the output reading to zero after the sensor was positioned over a stationary surface of white scattering material. To avoid optical interference between the LED's in the SaO_2 sensor and the HeNe laser source, the reflectance pulse oximeter was turned off when skin blood flow measurements were performed.

2) *Reflectance Pulse Oximeter*: The reflectance oximeter generates digital switching pulses to drive the red and infrared LED's in the sensor alternately at a repetition rate of 1 KHz. The time multiplexed output current from the photodiode, which correspond to the red and infrared light intensities reflected from the skin, is first converted to a proportional analog voltage using a low noise operational amplifier configured as a current-to-voltage converter. The resulting output voltage is subsequently decomposed into two separate channels using two sample-and-hold circuits synchronously triggered by the same pulses driving the respective LED's. The red and infrared photoplethysmograms produced are amplified and high-pass filtered (cut-off frequency 15 Hz) to separate the ac pulses from the dc signal of each photoplethysmogram. To enable further signal processing, the respective ac and dc signals of each photoplethysmogram were digitized at a rate of 100 samples/s by an IBM-AT personal computer equipped with a Tecmar 12 bit resolution A/D-D/A data acquisition board. From the recorded signals, a computer algorithm calculates the $I_r(\text{red})/I_r(\text{infrared})$ ratio for each heartbeat. These values are further averaged using a five-point running average algorithm. Another algorithm uses the averaged ratios to compute and display SaO_2 according to (1). The *A* and *B* coefficients necessary for calculating SaO_2 in the oximeter were determined previously in our laboratory based on a calibration study using the HP Model 47201A ear oximeter as a reference.

B. In Vivo Studies

Seven Caucasian volunteers participated in the studies which were approved by our institutional review board. The subjects, five males and two females, were healthy nonsmokers ranging in age from 21 to 29 years.

To establish a reference for measuring SaO_2 , we used the HP 47201A ear oximeter. The oximeter was standardized before each test by placing the ear probe in a special standardization chamber inside the ear oximeter. The ear probe was then attached to the anti-helix portion of the ear pinna with a head mount and elastic head band according to the manufacturer recommendations.

The sensor of the reflectance pulse oximeter was attached either to the volar side of the forearm or the anterior thigh region. In each case, the monitored arm or leg was immobilized in the horizontal position to minimize spurious movement artifacts.

The experimental setup used in our studies is illustrated in Fig. 3.

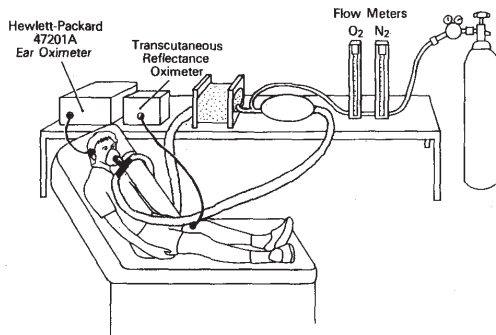

Fig. 3. Experimental setup illustrating the closed loop rebreathing circuit for obtaining different inspired O₂/N₂ concentrations and the attachment of the oximeter sensors to the subject's ear and thigh.

IV. RESULTS

Several *in vivo* studies were performed using the prototype optical reflectance sensor and oximeter as described above. The primary objectives of the first study were to investigate the effect of 1) source/detector separation and 2) local skin heating on the pulsatile component of the red and infrared photoplethysmograms detected by the sensor. In a separate *in vivo* study, we compared SaO₂ values measured by the pulse oximeter from the forearm and thigh of different subjects during progressive hypoxemia with simultaneous recordings obtained from the HP ear oximeter in the range between 70-100 percent.

A. Source/Detector Separation Studies

The purpose of these studies was to determine the relationship between different LED/photodiode separations and the magnitude of the pulsatile component of each reflection photoplethysmogram. We noticed that for a constant LED intensity, the light intensity detected by the photodiode decreases roughly exponentially as the radial distance from the LED's is increased. The same basic relationship applies to both the dc and ac components of the reflected photoplethysmograms as shown in Fig. 4. This is expected since the probability that the incident photons will be absorbed as they traverse a relatively longer path length before reaching the detector is increased.

Fig. 5 shows the relative pulse amplitude of the red and infrared reflected photoplethysmograms recorded from the forearm of one subject. In this study, the incident light intensities of the red and infrared LED's were adjusted by varying the LED driving currents such that for each separation distance the dc component of each photoplethysmogram remained relatively constant. Each point represents the average values obtained for five repeated experiments performed on the same subject. In each experiment, and for each separation distance, the data acquired were averaged over a 30 s time interval.

As shown in Fig. 5, by increasing the separation distance between the LED's and photodiode from 4 to 11

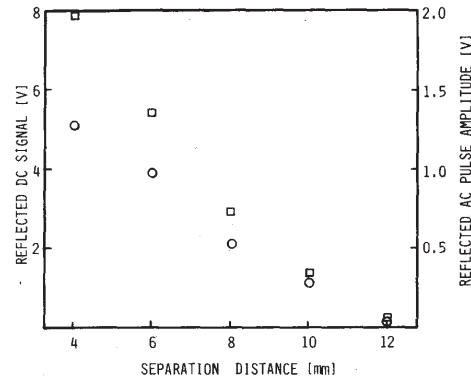

Fig. 4. The effect of LED/photodiode separation on the dc (□) and ac (○) components of the reflected infrared photoplethysmograms. Measurements were performed at a skin temperature of 43°C.

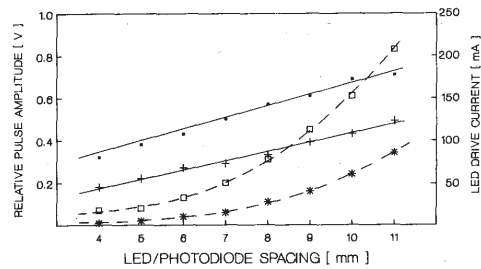

Fig. 5. Effect of LED/photodiode separation on the relative pulse amplitude of the red (+) and infrared (■) photoplethysmograms. The driving currents of the red (□) and infrared (★) LED's required to maintain a constant dc reflectance from the skin are shown for comparison.

mm, we were able to achieve almost a two-fold increase in the pulse amplitude of the infrared photoplethysmogram. Furthermore, as illustrated in Fig. 6, the mean beat-to-beat variations of the infrared photoplethysmograms, which were determined by calculating the respective coefficients of variation (i.e., the standard deviation divided by the mean for a 30 s time interval), decreased from about 7 to 3 percent. This trend indicates that the photoplethysmograms became progressively more stable as the LED/photodetector separation was increased. Similar trends were also observed for the reflected red photoplethysmograms.

B. Skin Heating Studies

Practically, it is difficult to detect large reflection photoplethysmograms from skin areas which are not very vascular, such as the chest and the limbs. In this study, we attempted to determine if local skin heating, which is known to produce vasodilatation of the microvascular bed, could be used as a practical mean to increase the pulsatile component of the reflected photoplethysmograms. Likewise, we sought to determine if skin heating could help to reduce the beat-to-beat variability in the pulsatile components of the recorded photoplethysmograms.

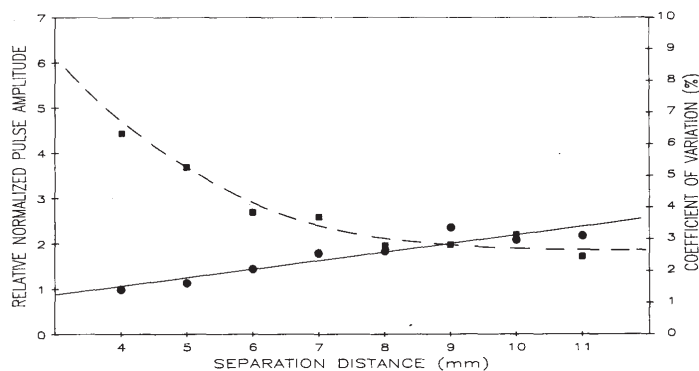

Fig. 6. Effect of LED/photodiode separation on the mean pulse amplitude (●) and the corresponding decrease in the beat-to-beat amplitude fluctuation (■) of the infrared photoplethysmograms expressed in terms of the coefficient of variation. Each pulse amplitude was normalized with respect to a separation distance of 4 mm.

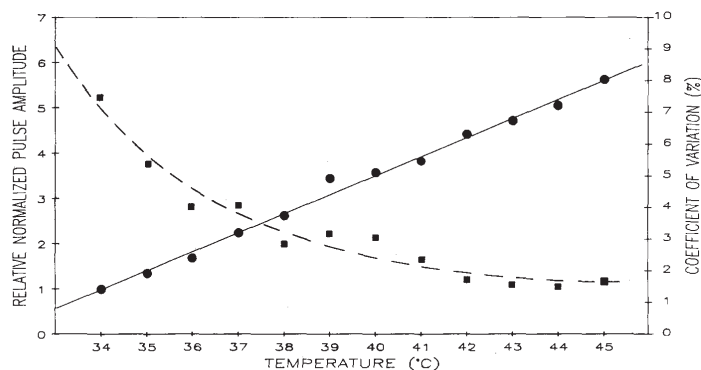

Fig. 7. Effect of skin temperature on the mean pulse amplitude (●) and the corresponding decrease in the coefficient of variation (■) of the infrared photoplethysmograms. Each pulse amplitude was normalized with respect to a separation distance of 4 mm.

Measurements were performed at a constant LED/photodiode separation of 6 mm while the subject was breathing ambient air. After attaching the reflectance sensor to the forearm, the surface of the skin was gradually heated to 45°C in 1°C step increments. The time needed to achieve a desired skin temperature depends on factors such as skin type, local blood flow, heat conductivity of the skin, and the temperature of the surrounding environment. Typically, we found that at each temperature setting, 5 min were sufficient for the skin temperature to reach steady state.

As shown in Fig. 7, by increasing the local skin temperature from 34° to 45°C, we were able to obtain a five-fold increase in the pulse amplitude of the infrared photoplethysmograms. Moreover, by heating the skin, the vascular bed under study becomes vasodilated and, there-

fore, the reflected photoplethysmograms become more stable resulting in smaller beat-to-beat amplitude fluctuations. Consequently, as our data show, the mean coefficient of variation decreased from approximately 7 to 2 percent. Similar trends were also observed for the reflected red photoplethysmograms.

The effect of local skin heating on the pulsatile component of the reflected photoplethysmograms is shown in Fig. 8. The relative skin blood flow for each temperature setting is also shown for comparison. It is clearly seen that as the temperature of the skin was increased from its initial value of 29° to 43°C, the pulse amplitude of the red and infrared photoplethysmograms increased accordingly. Furthermore, the mean pulse amplitude of the recorded waveforms remained relatively constant over a period of approximately 20 min after the heater was turned

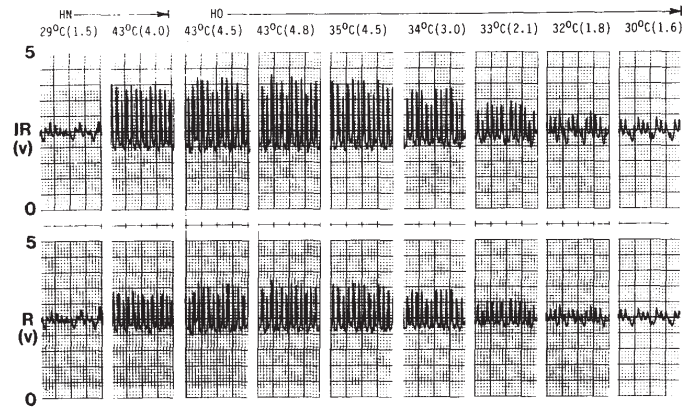

Fig. 8. Simultaneous recording of the infrared and red photoplethysmograms from the forearm at different skin temperatures. The numbers in parenthesis indicate the relative skin blood flows (scale: 0-10). Each record lasted approximately 15 s. The time elapsed between consecutive recordings is 10 min. *HN* = heater turned on, *HO* = heater turned off.

off. Thereafter, the pulse amplitude started to diminish. After about 50 min, the pulse amplitude returned to its initial level.

C. Hypoxemia Studies

Preliminary studies using our prototype reflectance sensor during progressive steady-state hypoxemia were conducted on a group of seven healthy adult volunteers.

Each subject was placed in a reclining position and asked to breathe different fractions of O_2/N_2 gas while maintaining spontaneous respiration. The inspired O_2/N_2 gas mixture was supplied through a fitted face mask by a closed-loop rebreathing circuit equipped with a CO_2 scrubber and a one-way breathing valve. The fractional inspired O_2 concentration ($F_I O_2$) was adjusted between 10 and 100 percent using separate gas flowmeters. The exact inspired $F_I O_2$ was monitored continuously with an Instrumentation Laboratory Model 408 oxygen monitor (Instrumentation Laboratories Inc., Lexington, MA) which was inserted in the inspiratory limb.

The skin reflectance sensor was attached to the volar side of the forearm and maintained at a constant temperature of $43^\circ C$. The spacing between the LED's and the photodiode in these experiments was set to 6 mm.

Initially, the $F_I O_2$ was changed in step decrements, each producing a 5 percent decrease in SaO_2 as measured by the reference HP ear oximeter. At each SaO_2 level, the inspired $F_I O_2$ was maintained at a constant level until both oximeters displayed stable readings.

For each step change in $F_I O_2$, SaO_2 readings from our prototype reflectance pulse oximeter were averaged over 60 s time intervals and compared to the corresponding SaO_2 values measured simultaneously by the HP ear oximeter. The averaged readings from all seven subjects were then pooled and a linear regression analysis was performed.

A comparison between the reflectance pulse oximeter and the HP ear oximeter readings obtained from all seven subjects is shown in Fig. 9. A total of 66 pairs of data points were used in this regression analysis. Linear regression analysis of this experimental data resulted in a slope of 0.93 and a positive y intercept of 6.22 percent ($r = 0.96$; $S.E.E. = 2.20$). The mean and standard deviation for the differences between the skin reflectance pulse oximeter and the HP SaO_2 readings were found to be -0.001 ± 2.27 , respectively.

In order to determine if repeatable SaO_2 measurements can be made also from body sites other than the forearm, we performed a similar series of experiments in which the sensor was applied to the thigh region of three different subjects. In these experiments, a total of 24 data points were obtained simultaneously from the reflectance pulse oximeter and the HP ear oximeter. Linear regression analysis of this data set revealed a slope of 0.93 and a positive y intercept of 6.5 percent ($r = 0.99$; $S.E.E. = 1.56$). The mean and standard deviation for the differences between the skin reflectance pulse oximeter and the HP SaO_2 readings were found to be -0.001 ± 1.61 , respectively.

The response of our prototype skin reflectance oximeter was further compared against simultaneous recordings of SaO_2 from the fingertip and earlobe made by a transmission pulse oximeter (Nellcor Model N-100, Nellcor, Inc., Hayward, CA) and the HP ear oximeter, respectively. The recordings, which are shown in Fig. 10, were obtained by asking the subject to hyperventilate and then hold his breath consecutively.

D. Multiple Photodetector Arrangement

The incident light emitted from the LED's diffuses in the skin in all directions. This is evident from the circular pattern of backscattered light surrounding the LED's. Therefore, by collecting the backscattered radiation using

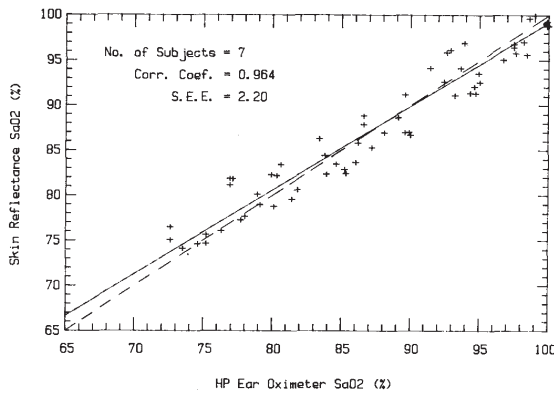

Fig. 9. Comparison of SaO_2 recorded simultaneously from the forearm and the ear by the skin reflectance pulse oximeter and the HP ear oximeter, respectively.

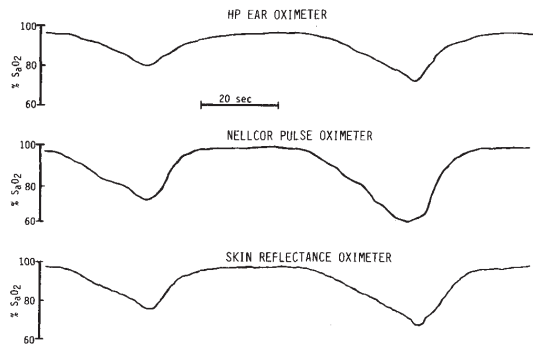

Fig. 10. Simultaneous recordings of SaO_2 from the HP ear oximeter, Nellcor pulse oximeter and the prototype reflectance pulse oximeter.

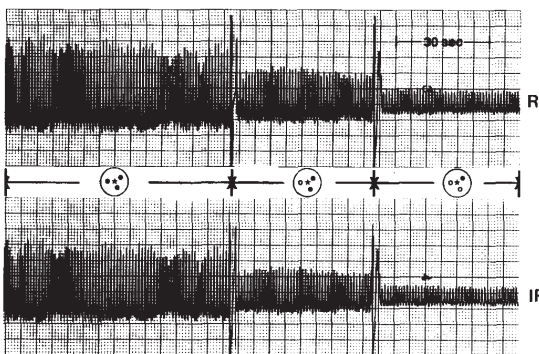

Fig. 11. Reflection photoplethysmograms recorded from the forearm using a combination of three photodiodes. The circles indicate the relative location of the photodiodes with respect to the LED's (*). The closed circles indicate the photodiodes which were used to collect the reflected light as shown by the corresponding traces.

several photodetectors, considerably larger photoplethysmograms could be detected.

To demonstrate the advantage of using multiple pho-

todetectors instead of only one, we modified our sensor and mounted two additional photodiodes similar in size and spectral response to that used originally. This enabled us to triple the total active area of the photodetector and thus collect a greater fraction of the backscattered light from the skin. Fig. 11 shows the spatial arrangement of all three photodiodes which were mounted symmetrically with respect to the red and infrared LED's. Also shown in this figure is the relative pulse amplitude of the red and infrared photoplethysmograms recorded from the forearm when the output currents of several photodiodes were summed simultaneously. As expected, we can see that by using multiple photodetectors a larger fraction of the backscattered radiation from the skin can be collected and, therefore, larger photoplethysmograms can be recorded.

V. DISCUSSION

The sensor designed for this study enabled us to examine the effect of LED/photodiode separation distance as well as skin heating on the pulse amplitude of the photoplethysmograms detected by a reflectance pulse oximeter sensor.

One of the requirements in designing a reflectance pulse oximeter sensor is to determine the optimum separation distance between the LED's and the photodiode. Obviously, this distance should be selected such that photoplethysmograms with maximum pulsatile components could be detected. Generally, the pulsatile component of the reflected photoplethysmograms depends not only on the systolic blood pulse in the peripheral vascular bed but also on the amount of arterial blood within the illuminated tissue volume.

The selection of each LED driving current determines the effective penetration depth of the incident light. For a given LED/photodiode separation, it is clear that with higher levels of incident light, a larger pulsatile vascular bed will be illuminated. Consequently, the reflected photoplethysmograms will contain a larger ac component. Practical considerations, however, limit the driving current of each LED to the manufacturer specified maximum power dissipation. Alternatively, by placing the photodetector too close to the LED's, the large dc component, which is mainly due to multiple scattering of the incident photons by the blood-free stratum corneum and epidermis layers in the skin, will cause the photodetector to become saturated.

It is important to point out that although the HP ear oximeter which was used as a reference in our studies is not an acceptable primary standard for measuring SaO_2 , its accuracy and reliability as a noninvasive oximeter have been widely established [11]-[13].

Our experience using the prototype reflectance sensor has shown that the pulse amplitude of the reflection photoplethysmograms depends among other factors on the position of the photodiode relative to the LED's. The selection of a particular separation distance, however, involves a tradeoff. On one hand, larger photoplethysmograms can be detected by mounting the photodiode further

apart from the LED's. On the other hand, higher LED driving currents are necessary to overcome the absorption of the incident light due to a longer optical path length.

The results of our studies also validated our hypothesis that skin heating is a feasible method for increasing the size of the reflected photoplethysmograms. We noticed that by heating the skin surface to 45°C, a five-fold increase in the pulsatile component could be achieved. We noticed also that the improvement due to skin heating can last up to 20 min from the time the temperature of the skin has reached 45°C and the heater was turned off. It is important to mention that the ability to measure accurate SaO₂ values by the prototype pulse oximeter sensor was independent of the exact skin temperature. We found that a minimum skin temperature of approximately 40°C is generally sufficient in order to detect adequate stable photoplethysmograms. Our experience in healthy adults has shown that at this temperature the heated sensor can remain in the same location for at least three hours without any apparent skin damage. It should be noted also that the principal objective of skin heating in our specific application is not to increase oxygen diffusion through the skin as in transcutaneous pO₂ monitoring although the vasodilatation effect of the applied heat on the vascular bed in the skin is basically the same.

The close correlation obtained between the prototype reflectance pulse oximeter, the HP ear oximeter and the Nellcor finger pulse oximeter is encouraging. We showed that the technique is sensitive and permits real time monitoring of SaO₂ from skin areas such as the forearm and the thigh. Further work, however, is needed in order to compare our reflectance pulse oximeter against SaO₂ measured directly from arterial blood samples and establish the potential of this technique in various clinical applications.

REFERENCES

- [1] R. Brinkman and W. G. Zijlstra, "Determination and continuous registration of the percentage oxygen saturation in clinical conditions," *Arch. Chir. Neurol.*, vol. 1, pp. 177-183, 1949.
- [2] A. Cohen and N. Wadsworth, "A light emitting diode skin reflectance oximeter," *Med. Biol. Eng. Comput.*, vol. 10, pp. 385-391, 1972.
- [3] S. Takatani, "On the theory and development of a noninvasive tissue reflectance oximeter," Ph.D. dissertation, Dep. Biomed. Eng., Case Western Reserve Univ., Cleveland, OH, 1978.
- [4] Y. Mendelson, "Theory and development of a transcutaneous reflectance oximeter system for noninvasive measurements of arterial oxygen saturation," Ph.D. dissertation, Dep. Biomed. Eng., Case Western Reserve Univ., Cleveland, OH, 1983.
- [5] Y. Mendelson, P. W. Cheung, M. R. Neuman, D. G. Fleming, and S. D. Cahn, "Spectrophotometric investigation of pulsatile blood flow for transcutaneous reflectance oximetry," presented at Proc. 5th Int. Symp. on Oxygen Transport to Tissue, 1981; also in *Advances Experimental Medicine Biology.*, H. I. Bicher and D. F. Bruley, Eds., vol. 159, 1983, pp. 93-102.

- [6] T. Aoyagi, M. Kishi, K. Yamaguchi, and S. Watanabe, "Improvement of the earpiece oximeter," in *Proc. Abstracts 13th Ann. Meet. Japanese Soc. Med. Electron. Biologic Eng.*, 1974, Japan, pp. 90-91.
- [7] S. Nakajima, Y. Hirai, H. Takase, A. Kuse, S. Aoyagi, M. Kishi, and K. Yamaguchi, "New pulse-type ear oximeter," *Kokyu to Junkan*, vol. 23, pp. 709-713, 1975 [Japan].
- [8] I. Yoshiya, Y. Shimada, and K. Tanaka, "Spectrophotometric monitoring of arterial oxygen saturation on the fingertip," *Med. Biol. Eng. Comput.*, vol. 18, pp. 27-32, 1980.
- [9] E. B. Merrick and T. J. Hayes, "Continuous, noninvasive measurements of arterial blood oxygen levels," *Hewlett-Packard J.*, vol. 28, no. 2, pp. 2-9, 1976.
- [10] G. A. Holloway, "Laser Doppler measurement of cutaneous blood flow," in *Non-Invasive Physiological Measurements, vol. II*, P. Rolfe, Ed. New York: Academic, 1983.
- [11] M. R. Flick and A. J. Block, "In vivo continuous arterial oxygen saturation measurement by oximetry," *Amer. Rev. Respir. Dis.*, vol. 113, p. 126, 1976.
- [12] N. A. Saunders, A. C. P. Powles, and A. S. Rebeck, "Ear oximetry: Accuracy and practicability in the assessment of arterial oxygenation," *Amer. Rev. Respir. Dis.*, vol. 113, p. 745, 1976.
- [13] N. J. Douglas, H. M. Brash, P. K. Wraith, P. M. A. Calverley, R. J. E. Leggett, L. McElderry, and D. C. Flenley, "Accuracy, sensitivity to carboxyhemoglobin, and speed of response of the Hewlett-Packard 47201A ear oximeter," *Amer. Rev. Respir. Dis.*, vol. 119, pp. 311-313, 1979.

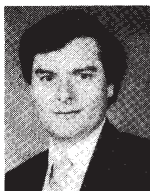

Yitzhak Mendelson (S'79-M'82) was born in Tel-Aviv, Israel, in 1949. He received the B.S. and M.S. degrees in electrical engineering from the State University of New York, Buffalo, in 1975 and 1976, respectively, and the Ph.D. degree in biomedical engineering from Case Western Reserve University, Cleveland, OH, in 1983.

He is currently an Assistant Professor of Biomedical Engineering at Worcester Polytechnic Institute, Worcester, MA. His research interests are in developing invasive and noninvasive techniques for blood gas measurements, biomedical sensors, microprocessor-based medical instrumentation, and the study of light interaction with biological media.

Dr. Mendelson is a member of the Biomedical Engineering Society, AAMI, and the Optical Society of America.



Burt D. Ochs (S'80-M'86) was born in the Bronx, NY, in 1957. He received the A.A.S. degree in electrical technology from Westchester Community College, NY, in 1981, the B.S.E.E. degree from Boston University, Boston, MA, in 1983 and is currently completing the M.S. degree in biomedical engineering at Worcester Polytechnic Institute, Worcester, MA.

In 1986 he joined ABIOMED, Inc., Danvers, MA, as a Senior Electrical Engineer in research and development. He is currently involved in total artificial heart research and dental diagnostic instrumentation.