

[54] VARIABLE STIFFNESS RULE BLADE, RULE EMPLOYING SAME, AND METHOD OF MAKING SAME

2,319,724 5/1943 Dinhofer 33/138
2,410,420 11/1946 Bennett 33/138

[75] Inventors: Edward C. Rutty, Portland; Carl C. Stoutenberg, Burlington, both of Conn.

FOREIGN PATENT DOCUMENTS

9823 4/1980 European Pat. Off. 33/138
2902882 1/1979 Fed. Rep. of Germany 33/138
104305 7/1899 Fed. Rep. of Germany 33/138
1193809 3/1958 France 33/138

[73] Assignee: The Stanley Works, New Britain, Conn.

Primary Examiner—Willis Little

[21] Appl. No.: 430,730

[57] ABSTRACT

[22] Filed: Sep. 30, 1982

A coilable measuring blade for coilable rules has a concavo-convex cross section which has an intermediate portion with a smaller arc and greater height extending through and beyond the normal standout length to provide greater standout length. The blade may also have an outer terminal portion of greater height to require its deflection as it enters the rule casing and thereby provide reduction of the speed with which the blade is being retracted into the casing.

[51] Int. Cl.³ G01B 3/02

[52] U.S. Cl. 33/138; 242/84.8

[58] Field of Search 33/138, 137 R; 242/84.8

[56] References Cited

U.S. PATENT DOCUMENTS

950,581 3/1910 Tracy 33/138
1,730,199 10/1929 Farrand 33/138
2,050,941 8/1936 Farrand 33/138

25 Claims, 20 Drawing Figures

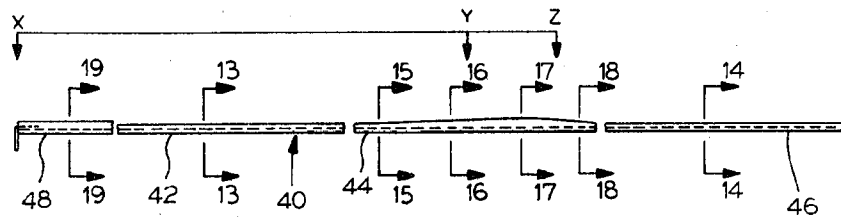

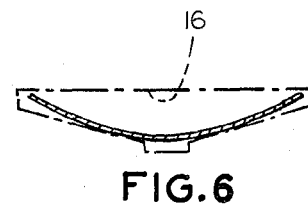
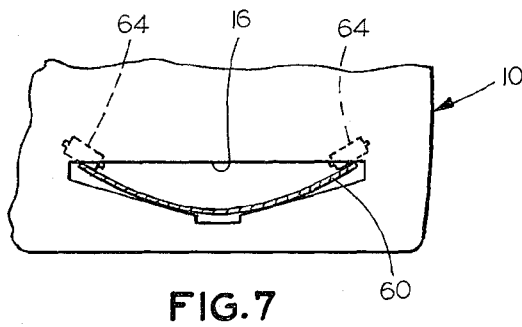
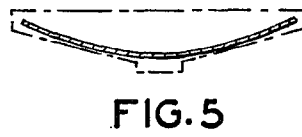
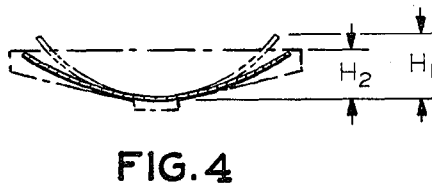
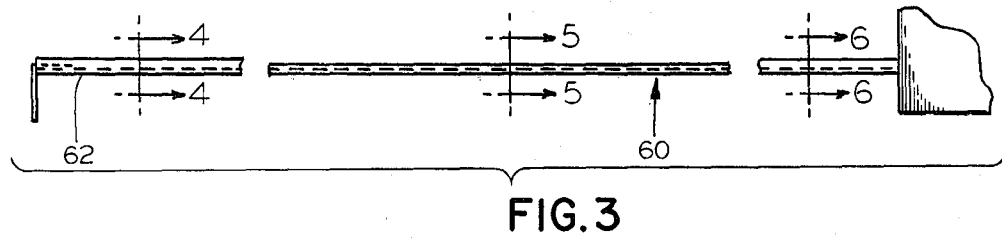
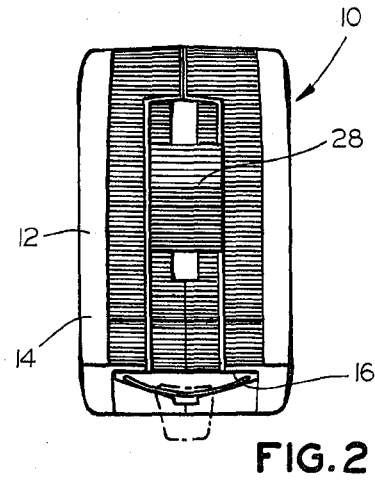
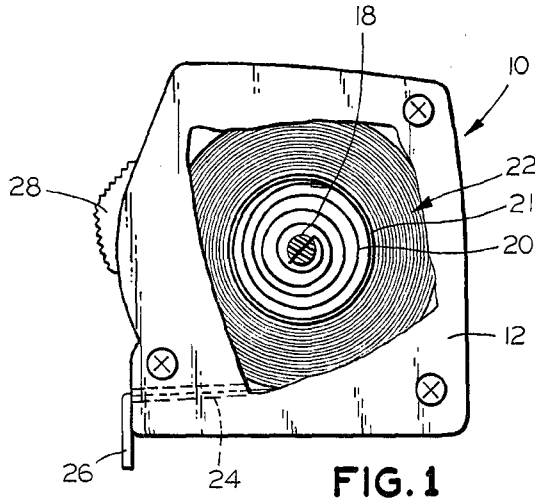

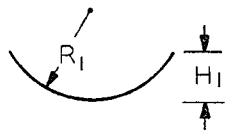
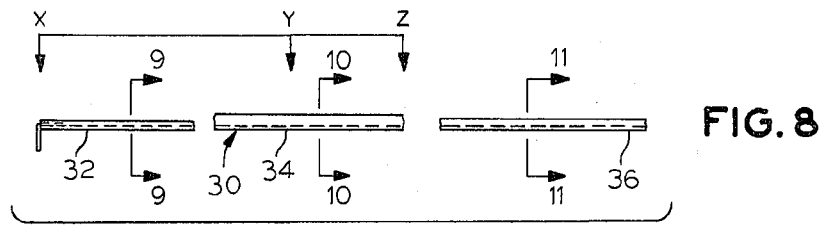

FIG. 9

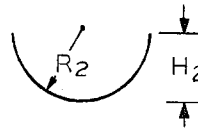

FIG. 10

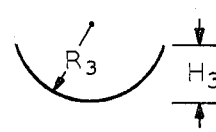

FIG. 11

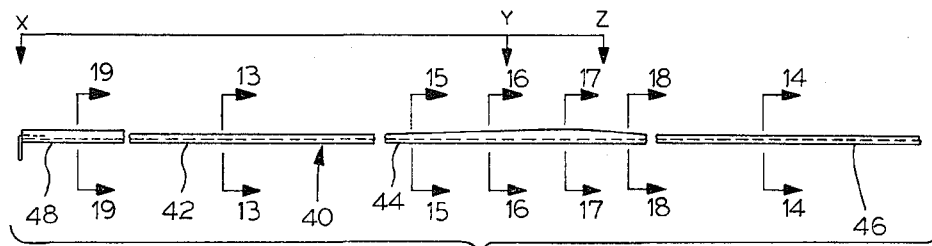

FIG. 12

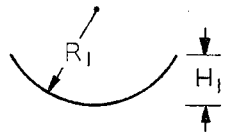

FIG. 13

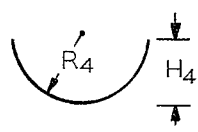

FIG. 19

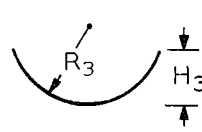

FIG. 14

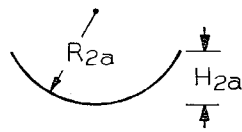

FIG. 15

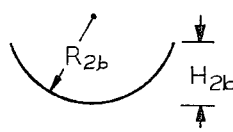

FIG. 16

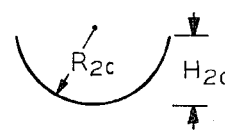

FIG. 17

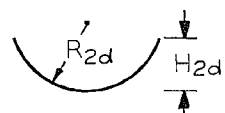

FIG. 18

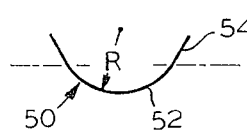

FIG. 20

VARIABLE STIFFNESS RULE BLADE, RULE EMPLOYING SAME, AND METHOD OF MAKING SAME

BACKGROUND OF THE INVENTION

The present invention relates to coilable rules and more particularly to such rules employing coilable metal blades with greater stand out length when unsupported as extended from the casing.

Coilable metal rules are widely used and frequently employ a concavo-convex cross section or other cross sectional configuration which will stiffen the blade so that the user may singlehandedly bridge a distance with the blade tip extended in a straight line. This enables the user to bridge doorways, shaftways, excavations and the like with the unsupported blade. It is known that the degree of curvature or cross section will influence and substantially determine the stand out length (the length of the blade which can be extended unsupported without collapsing at the support point) or breakpoint (the point at which the unsupported rule will collapse) for a rule of any particular width, thickness and metal characteristics.

Such blades are generally used in power returnable coilable rules that include a coiled spring which has the effect of retracting the extended blade into the rule housing or casing wherein it coils about the reel in its retracted position. It will be appreciated that the concavo-convex cross section of the blade is flattened as it is coiled within the rule casing, whether by manual action or by the retracting effect of such a power return spring. The stiffer the blade, the more spring power required to effect such flattening of the blade upon retraction.

As is also well known, blades employing such a concavo-convex cross section generally must be heat treated to achieve the desired flexural characteristics to withstand the repeated flattening operation that occurs in the coiling of the blade within the rule casing. It has been necessary to balance the advantages to be gained by increasing the depth of curvature of the blade for increased length of blade stand out with the power requirements for the spring to effect its retraction and also with the life characteristics resulting from repeated deflection into the flattened condition when the blade is coiled.

Moreover, because the extended blade will assume the concavo-convex cross section, the indicia which are imprinted thereon become more difficult to read when the arcuate cross section becomes steeper. Lastly, when there is a very high cross curve or deep cross section, there is a stress point at the point where the blade does buckle when fully extended, which, over repeated usage, may cause a stress fracture.

Because of the necessity for balancing these various factors, the range of average stand out lengths for commercially available widths of concavo-convex blades is set forth in the following table:

BLADE WIDTH, INCHES	STAND OUT LENGTH, INCHES
1/4	12-16
1/2	35-43
3/4	55-73
1	86-97

Various cross sections have been used for the concavo-convex blade construction. Generally, the cross section is a segment of a circular arc or a segment of a circular arc with straight segments at its ends (e.g. rectilinear portions which are tangential to the center arcuate segment). In this manner the concavo-convex cross section will not have any sharp bends which would produce points where the blade will be overstressed during the repeated flattening operation, and the amount of force required to flatten the curve is more readily available from economically utilizable power return springs.

It is an object of the present invention to provide a novel coilable metal blade for a rule which provides greater stand out length.

It is also an object to provide such a blade which can be readily and economically fabricated and which will enjoy long life.

Another object is to provide such a blade which will slow the rate of retraction as the blade is almost fully retracted into the casing.

A further object is to provide a novel rule employing such a blade and which may be fabricated readily and relatively economically.

Yet another object is to provide a novel method for fabricating such coilable metal rule blades offering enhanced or great stand out.

SUMMARY OF THE INVENTION

It has now been found that the foregoing and related objects may be readily attained in a coilable rule blade providing greater stand out length and comprising an elongated strip of resiliently deflectable metal having a substantially uniform width in its coiled flattened state and, in its uncoiled state, a concavo-convex cross section along substantially its entire length. This concavo-convex cross section has a central segment of arcuate configuration defined by a radius R and has a depth H.

The blade has a first portion adjacent one end thereof having a depth H1 and a radius R1, a second portion which extends from the first portion and has a depth H2 and a radius R2, and a third portion which extends from the second portion to adjacent the other end with a depth H3 and a radius R3. The depth H2 of the second portion is greater than the depth H1 and H3 of the first and third portions, and its radius R2 is less than the radii R1 and R3 of the first and third portions. The second portion extends for a portion of the length of the blade including the normal breakpoint for a blade of that width and having a uniform cross section corresponding to the depth H1 and radius R1 of the first portion, and the second portion continues beyond such breakpoint towards the other end of the blade to provide the greater stand out length.

In its preferred form, the entire cross section of each of the blade portions is defined by a single continuous arc of the respective radius, or the cross section of each of the blade portions includes substantially rectilinear segments tangential to the ends of the central arcuate segment.

Conveniently, the depth H3 and radius R3 of the third blade portion are substantially equal to the radius R1 and depth H1 of the first blade portion. The radius R2 and depth H2 of the segment in the second blade portion is conveniently substantially uniform over substantially the entire length of the second portion for ease of fabrication. However, a highly effective structure is one in which the radius R2 of the arcuate segment of the sec-

ond portion decreases in length and the depth H_2 increases from the first portion towards the third portion of the blade. In such an embodiment, the decrease in radius R_2 and increase in depth H_2 in the second portion is preferably at a substantially uniform rate over substantially the entire length of the second portion. However, the radius R_2 of the second portion most desirably increases, and the depth H_2 correspondingly decreases, at a rapid rate adjacent the third portion so as to blend thereinto. In one embodiment, the blade has a terminal portion adjacent its one or outer end which has a radius R_4 for its arcuate segment which is smaller than the radius R_1 , and it correspondingly has a depth H_4 greater than the depth H_1 , of the first portion of the blade.

The blade is used in a coilable rule assembly which includes a casing having end walls and a peripheral sidewall defining a chamber therebetween and in which the sidewall has an exit aperture therethrough. As is conventional, the coiled rule blade in the chamber has one end extending outwardly of the casing aperture. The rule assembly will generally include a coiled power return spring within a reel in the chamber and which has its outer end engaged with the inner end of the blade which is coiled thereabout.

In one embodiment, the rule casing cooperates with a blade having a deeper cross section for its outer end portion and has an exit aperture which is of a depth H_5 less than the depth H_4 of the terminal portion of the blade so as to cause deflection thereof as it passes therethrough to reduce the rate of retraction of the blade under the action of the power return spring.

In making the coilable rule blade, a length of resiliently deflectable metal strip having a width W is provided, and the blade is formed to provide in a first portion of the length a concavo-convex cross section having a central segment of arcuate configuration defined by a radius R_1 and having a depth H_1 . A second portion of the length is formed into a concavo-convex cross section having a central segment of arcuate configuration defined by a radius R_2 and having a depth H_2 , and the radius R_2 is less than, and the depth H_2 is greater than, R_1 and H_1 , respectively. A third portion of the length extending from the second portion is formed into a concavo-convex cross section having a central segment of arcuate configuration defined by a radius R_3 and having a depth H_3 , with the radius R_3 being greater than, and the depth H_3 being less than, R_2 and H_2 , respectively.

The forming step may be by a cold forming technique in which the length is hardened and tempered and thereafter roll formed to shape the several portions of the length into the desired cross section, or by a hot forming technique in which the heated blade is roll formed, quenched and tempered. Conveniently, the several portions of the length of metal strip are formed initially in a roll forming operation in which the length is passed through a series of roll forming dies providing a constant configuration for the several portions, and thereafter the second portion is further formed to the desired configuration. If so desired, a section of the length of strip at the end of the first portion which is spaced from the second portion may be formed into a concavo-convex cross section having a central segment of deep arcuate cross section defined by a radius R_4 and a depth H_4 respectively lesser and greater than R_1 and H_1 .

BRIEF DESCRIPTION OF THE DRAWINGS

FIG. 1 is a elevational view of a power returnable coilable rule embodying the present invention with a portion of the housing end wall broken away to reveal internal construction;

FIG. 2 is a side elevational view thereof with the end hook in phantom line for clarity of illustration of the exit aperture in the housing;

FIG. 3 is a fragmentary elevational view of the rule with the blade partially extended from the housing;

FIG. 4 is a partially diagrammatic cross sectional view of the blade at the line 4—4 of FIG. 3 with the housing exit aperture shown in phantom line and with the blade cross section shown in full line as deflected for passage therethrough and in phantom line before such deflection;

FIG. 5 is a similar diagrammatic sectional view of the blade at the line 5—5 in the housing exit aperture;

FIG. 6 is a similar diagrammatic sectional view of the blade at line 6—6 in the housing exit aperture;

FIG. 7 is a fragmentary side elevational view of another embodiment of rule using guide rollers in the rule housing for the blade adjacent the exit aperture and with the blade shown in section;

FIG. 8 is a fragmentary side elevational view of the blade showing the several portions thereof;

FIGS. 9—11 are sectional views thereof along the section lines 9—9, 10—10 and 11—11 of FIG. 8;

FIG. 12 is a fragmentary side elevational view of another blade embodying the present invention;

FIGS. 13—19 are sectional views thereof along the section lines 13—13, 14—14, 15—15, 16—16, 17—17, 18—18 and 19—19 of FIG. 12; and

FIG. 20 is a cross sectional view of another embodiment of blade employing a modified cross section.

DETAILED DESCRIPTION OF THE ILLUSTRATED EMBODIMENTS

Turning first to FIGS. 1 and 2, therein illustrated is a power returnable coilable blade embodying the present invention and having a housing generally designated by the numeral 10 with end walls 12 and a peripheral sidewall 14 extending therebetween and in which there is provided an exit aperture 16. The walls 12, 14 define an internal cavity in which there is a hub 18, and a coiled power return spring 20 thereabout which has its outer end secured to the inner end of the blade generally designated by the numeral 22 and which is coiled about the reel 21. The terminal portion of the blade 22 extends through the passage 24 and outwardly of the exit aperture 16. As is conventional, a hook 26 is provided at its end which abuts the sidewall 14 about the aperture 16 and limits movement of the blade 20 inwardly of the housing 10.

Also shown is a blade locking lever 28 which cooperates with mechanism (not shown) within the casing to hold the blade 20 in an extended position as originally illustrated and described in Robert F. West U.S. Pat. No. 3,214,836 granted Nov. 2, 1965.

Turning next to FIGS. 3—11, therein fragmentarily illustrated are the several portions of an uncoiled blade generally designated by the numeral 30 and which is of substantially uniform width in its flattened or coiled condition and of concavo-convex cross section in its relaxed or extended position. The outer or first end portion 32 of the blade 30 has an arcuate cross section defined by a radius R_1 , and it has a depth or height H_1 .

Explore Litigation Insights

Docket Alarm provides insights to develop a more informed litigation strategy and the peace of mind of knowing you're on top of things.

Real-Time Litigation Alerts



Keep your litigation team up-to-date with **real-time alerts** and advanced team management tools built for the enterprise, all while greatly reducing PACER spend.

Our comprehensive service means we can handle Federal, State, and Administrative courts across the country.

Advanced Docket Research



With over 230 million records, Docket Alarm's cloud-native docket research platform finds what other services can't. Coverage includes Federal, State, plus PTAB, TTAB, ITC and NLRB decisions, all in one place.

Identify arguments that have been successful in the past with full text, pinpoint searching. Link to case law cited within any court document via Fastcase.

Analytics At Your Fingertips



Learn what happened the last time a particular judge, opposing counsel or company faced cases similar to yours.

Advanced out-of-the-box PTAB and TTAB analytics are always at your fingertips.

API

Docket Alarm offers a powerful API (application programming interface) to developers that want to integrate case filings into their apps.

LAW FIRMS

Build custom dashboards for your attorneys and clients with live data direct from the court.

Automate many repetitive legal tasks like conflict checks, document management, and marketing.

FINANCIAL INSTITUTIONS

Litigation and bankruptcy checks for companies and debtors.

E-DISCOVERY AND LEGAL VENDORS

Sync your system to PACER to automate legal marketing.