

(12) **United States Patent**
Dowling et al.

(10) **Patent No.:** **US 6,574,239 B1**
(45) **Date of Patent:** **Jun. 3, 2003**

- (54) **VIRTUAL CONNECTION OF A REMOTE UNIT TO A SERVER**
- (76) Inventors: **Eric Morgan Dowling**, 1132 W. Lookout Dr., Richardson, TX (US) 75080; **Mark Nicholas Anastasi**, 405 Copperas Trail, Highland Village, TX (US) 75077
- (*) Notice: Subject to any disclaimer, the term of this patent is extended or adjusted under 35 U.S.C. 154(b) by 0 days.

5,757,890 A	5/1998	Venkatakrishnan	
5,771,353 A *	6/1998	Eggleston et al.	709/227
5,896,444 A	4/1999	Perlman et al.	
5,903,602 A	5/1999	Torkkel	
5,958,006 A *	9/1999	Eggleston et al.	709/206
6,023,493 A	2/2000	Olafsson	
6,101,531 A *	8/2000	Eggleston et al.	709/206
6,308,281 B1	10/2001	Hall, Jr. et al.	
6,317,455 B1	11/2001	Williams et al.	
6,426,946 B1	7/2002	Takagi et al.	

- (21) Appl. No.: **09/167,698**
- (22) Filed: **Oct. 7, 1998**
- (51) **Int. Cl.⁷** **H04J 3/00**
- (52) **U.S. Cl.** **370/469; 370/329**
- (58) **Field of Search** **370/329, 389, 370/468, 469; 709/203, 206, 227**

(56) **References Cited**

U.S. PATENT DOCUMENTS

4,285,061 A	8/1981	Ho
4,416,015 A	11/1983	Gitlin
4,489,416 A	12/1984	Stuart
4,578,796 A	3/1986	Charalambous et al.
4,852,151 A	7/1989	Dittakavi et al.
4,995,074 A	2/1991	Goldman et al.
5,127,051 A	6/1992	Chan et al.
5,287,401 A	2/1994	Lin
5,321,722 A	6/1994	Ogawa
5,367,563 A	11/1994	Sainton
5,519,767 A	5/1996	O'Horo
5,600,712 A	2/1997	Hanson et al.
5,751,796 A	5/1998	Scott et al.

FOREIGN PATENT DOCUMENTS

WO WO 99/27702 6/1999

* cited by examiner

Primary Examiner—Salvatore Cangialosi
(74) *Attorney, Agent, or Firm*—Eric M. Dowling

(57) **ABSTRACT**

A method is provided for reconnecting a telephone modem with a reduced delay by reducing a time associated with retraining. A wireline communication connection is initialized by a telephone modem to train a set of parameters. The parameters are stored in a memory structure. The connection is used for communication, and is then terminated. At a later time, the connection is reestablished by accessing the parameters from memory and using them to reconnect the modem with a reduced set-up delay. Another method involves coupling to a first physical layer and establishing a session with a server, and then decoupling from the first physical layer while maintaining the session. Later, the session is resumed using a second physical layer. At least one of the physical layers involves a local interface unit that includes a landline connection to a WAN.

75 Claims, 4 Drawing Sheets

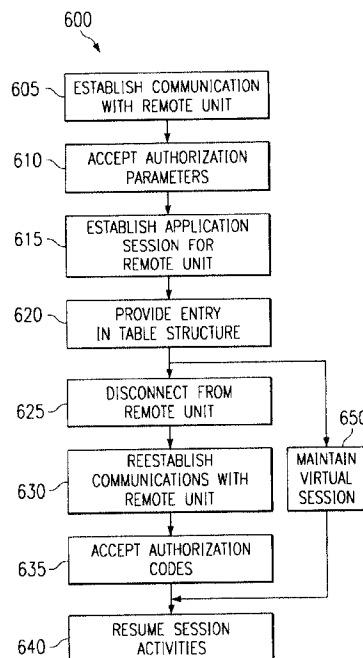

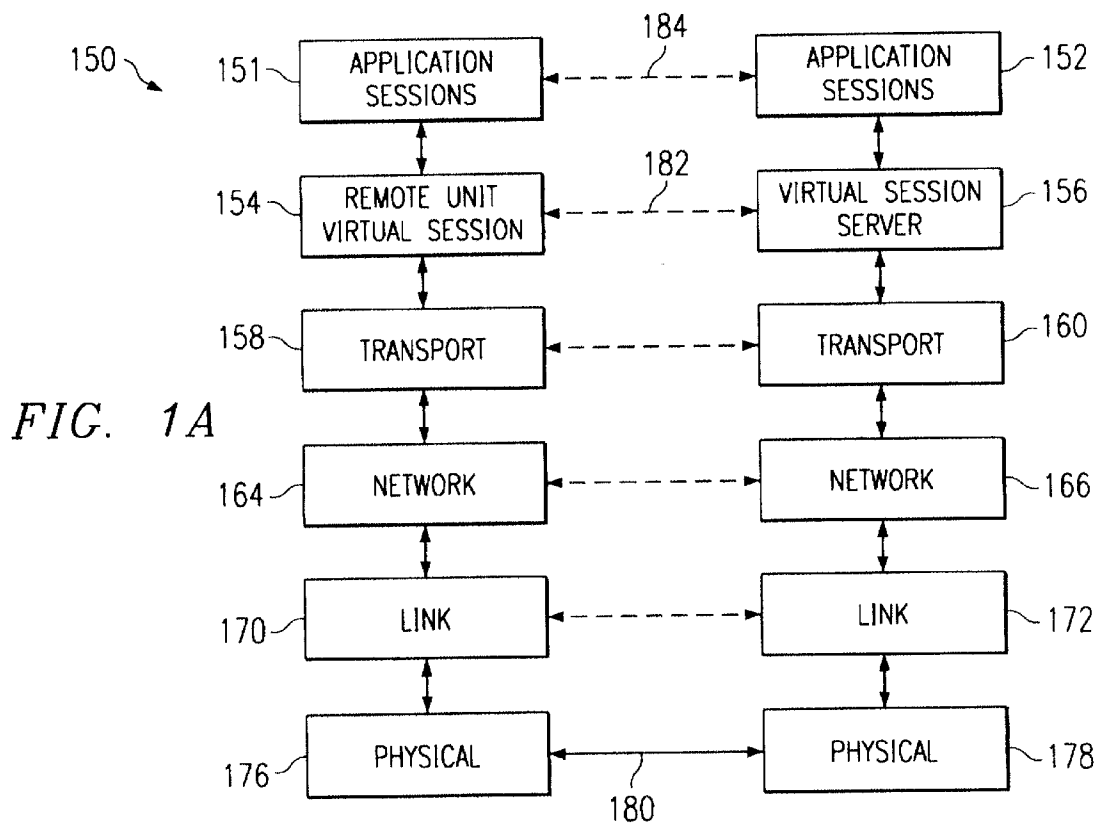
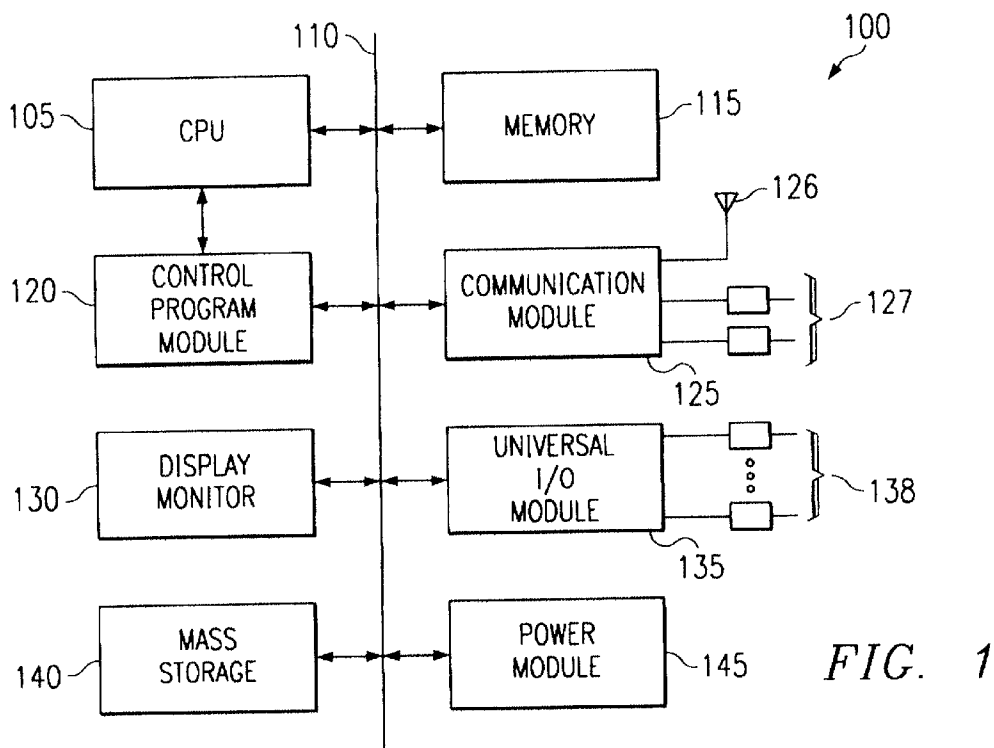

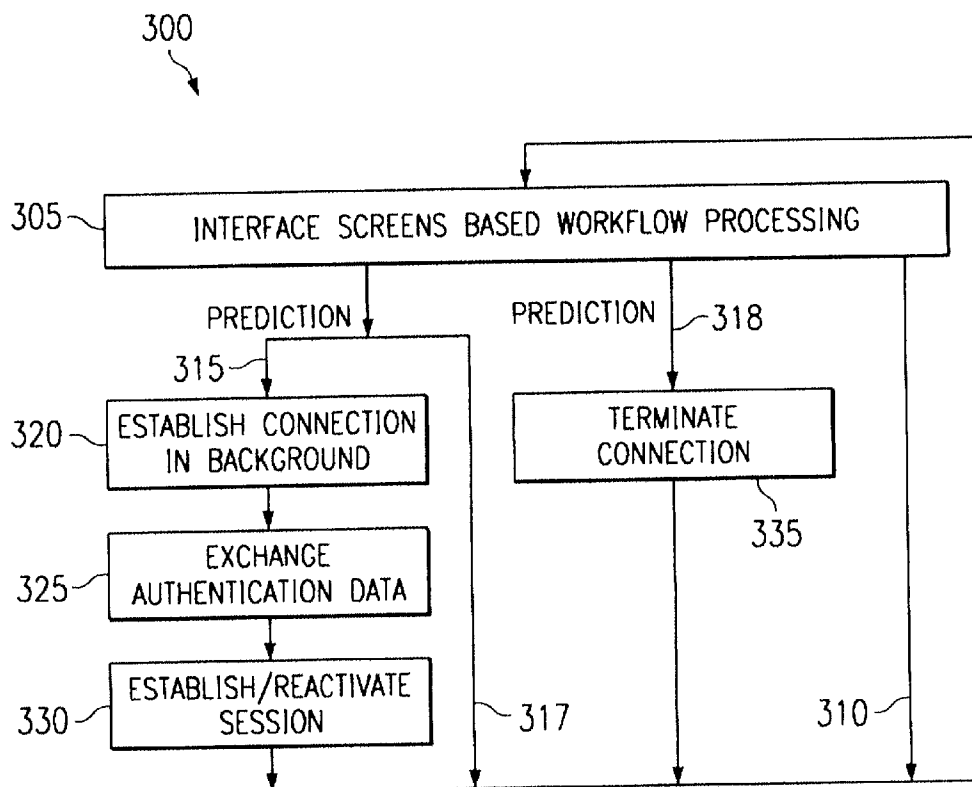
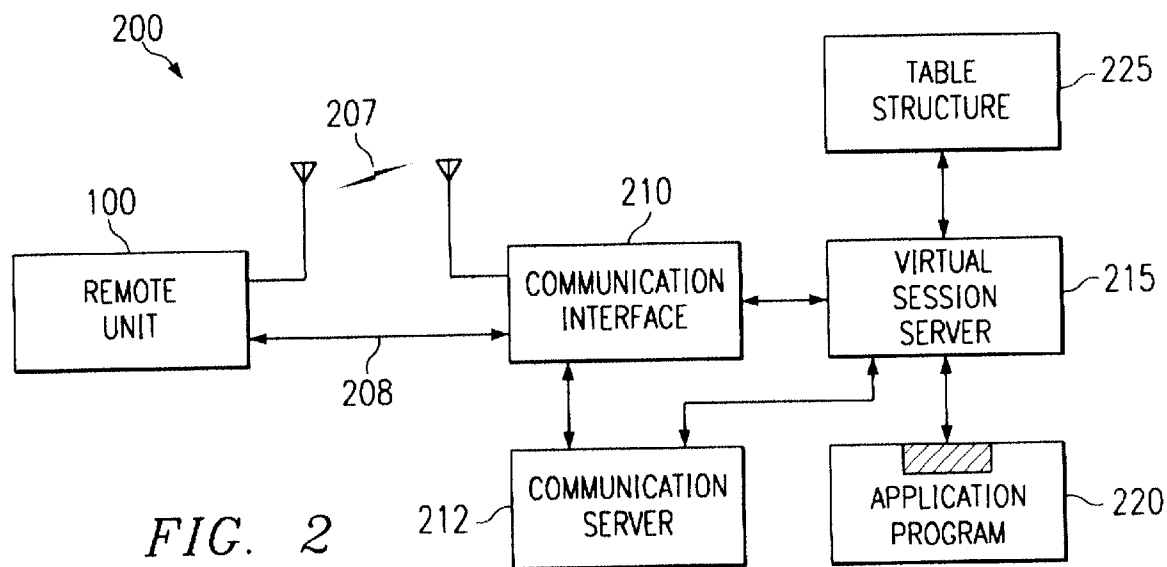

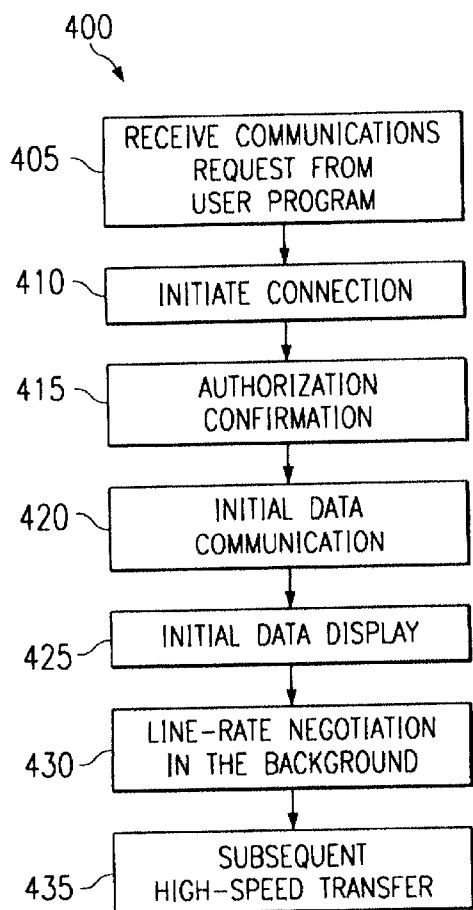

FIG. 4

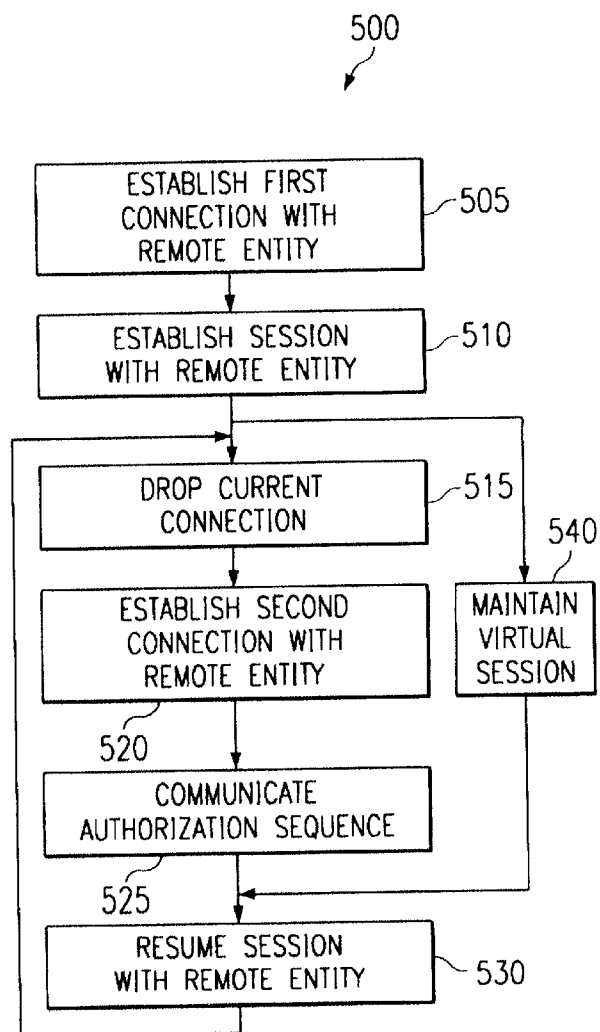

FIG. 5

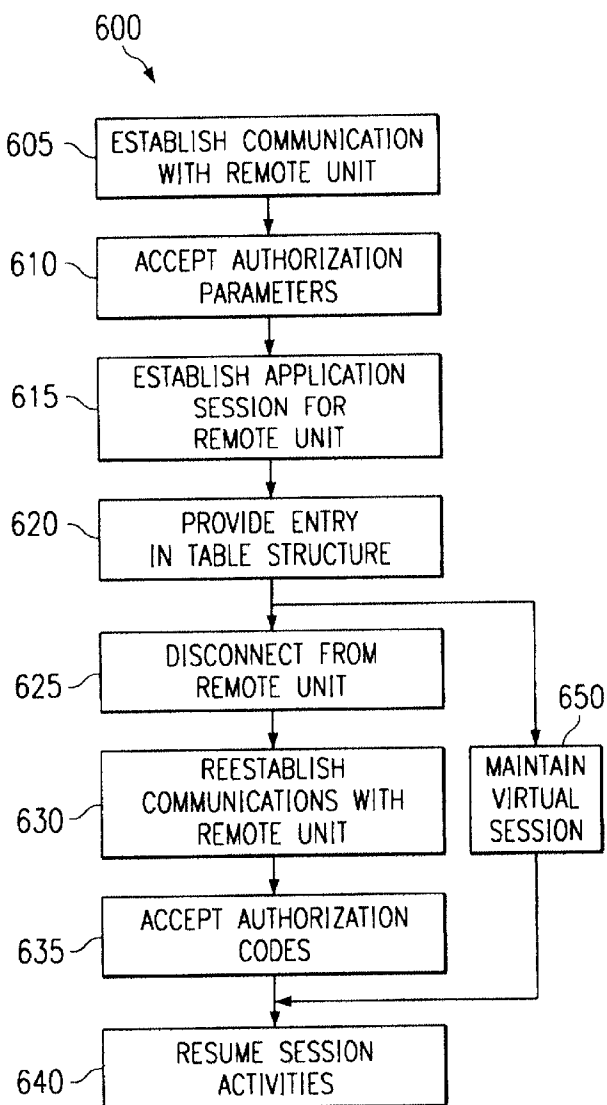

FIG. 6

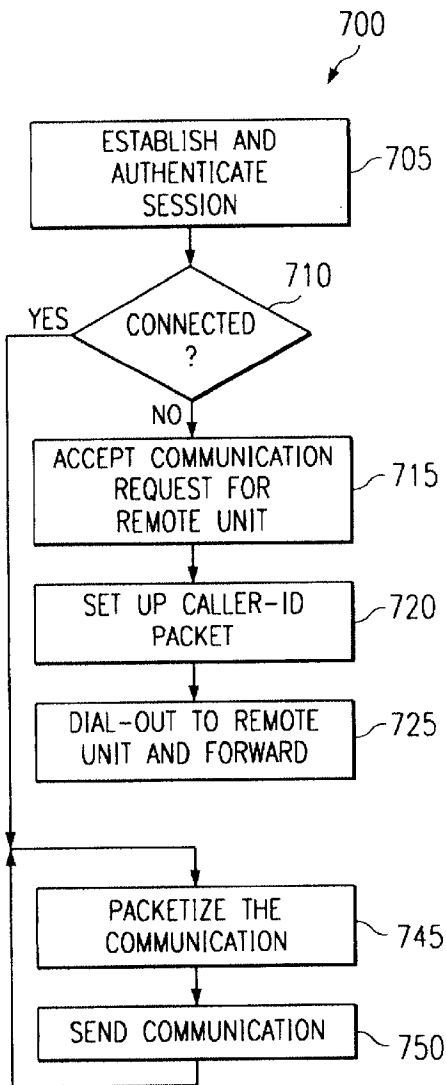

FIG. 7

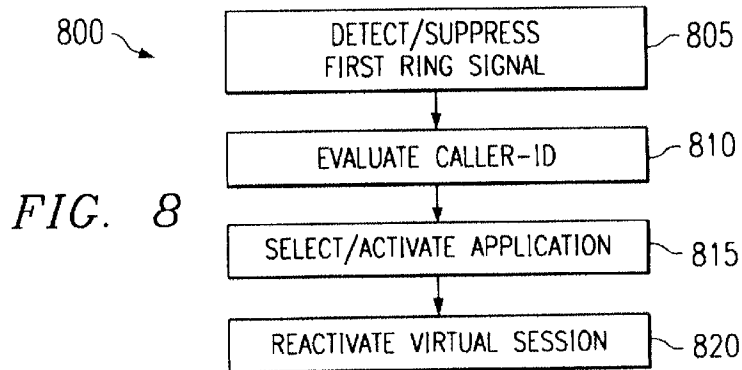

FIG. 8

Explore Litigation Insights

Docket Alarm provides insights to develop a more informed litigation strategy and the peace of mind of knowing you're on top of things.

Real-Time Litigation Alerts



Keep your litigation team up-to-date with **real-time alerts** and advanced team management tools built for the enterprise, all while greatly reducing PACER spend.

Our comprehensive service means we can handle Federal, State, and Administrative courts across the country.

Advanced Docket Research



With over 230 million records, Docket Alarm's cloud-native docket research platform finds what other services can't. Coverage includes Federal, State, plus PTAB, TTAB, ITC and NLRB decisions, all in one place.

Identify arguments that have been successful in the past with full text, pinpoint searching. Link to case law cited within any court document via Fastcase.

Analytics At Your Fingertips



Learn what happened the last time a particular judge, opposing counsel or company faced cases similar to yours.

Advanced out-of-the-box PTAB and TTAB analytics are always at your fingertips.

API

Docket Alarm offers a powerful API (application programming interface) to developers that want to integrate case filings into their apps.

LAW FIRMS

Build custom dashboards for your attorneys and clients with live data direct from the court.

Automate many repetitive legal tasks like conflict checks, document management, and marketing.

FINANCIAL INSTITUTIONS

Litigation and bankruptcy checks for companies and debtors.

E-DISCOVERY AND LEGAL VENDORS

Sync your system to PACER to automate legal marketing.